



HAL
open science

Genetics, domestication and green energy: translational photosynthesis towards algal and crop improvement

Xenie Johnson

► **To cite this version:**

Xenie Johnson. Genetics, domestication and green energy: translational photosynthesis towards algal and crop improvement. Life Sciences [q-bio]. Aix-Marseille Université (AMU), 2018. tel-01972316

HAL Id: tel-01972316

<https://cea.hal.science/tel-01972316>

Submitted on 7 Jan 2019

HAL is a multi-disciplinary open access archive for the deposit and dissemination of scientific research documents, whether they are published or not. The documents may come from teaching and research institutions in France or abroad, or from public or private research centers.

L'archive ouverte pluridisciplinaire **HAL**, est destinée au dépôt et à la diffusion de documents scientifiques de niveau recherche, publiés ou non, émanant des établissements d'enseignement et de recherche français ou étrangers, des laboratoires publics ou privés.

Dr Xenie JOHNSON
Aix Marseille Université
DEMANDE d'HABILITATION à DIRIGER des RECHERCHES

**Titre: Genetics, domestication and green energy:
translational photosynthesis towards algal and crop
improvement**

Spécialité : Biologie

CNU: 64

Présentée par

Xenie JOHNSON

Date de soutenance : 28 Novembre 2018

JURY:

Rapporteurs

Dr. Anja Krieger Liskay, Directeur de Recherche au CNRS CEA Saclay

Prof. Christoph Robaglia, Professeur Université Aix-Marseille Luminy

Dr. Angela Falciatore, Directeur de Recherche au CNRS IBPC Paris

Examineurs

Prof. Dr. Michael Hippler, Professeur University of Münster, Germany

Dr. Michel Havaux, Directeur de Recherche au CEA, Cadarache

Acknowledgements

Sincere thanks go to my tuteur, Michel Havaux, for his encouragement and help during the preparation of this manuscript. I would also like to thank Jean Alric for serious discussions (and tutorials) relating to the quantifications of photosynthetic efficiency found within these pages and his continued support and encouragement of my work. Warm thanks go to Bernard Genty for enthusiastic and deeply knowledgeable discussions related to pretty much everything found in these pages.

Thank you to the jury members for agreeing to take the time to examine this work and for putting up with the complications of organizing the oral exam. Special thanks to Yolande Tinel from AMU for her support throughout the process and to Frederic Barras for examining the first draft of the manuscript.

Table of Contents

1. CV.....	3
2. List of publications.....	7
3. Plants, genetics, domestication and green energy: a brief explanation of my scientific path.....	11
4. The teeth cutting experiences: Part A. Soluble carbohydrates in monocotyledonous plants.....	14
Part B. Branching and long distance signaling in pea <i>rms</i> mutants.....	20
Part C. Biogenesis of the photosynthetic apparatus in <i>Chlamydomonas reinhardtii</i>	27
5. The alternative electron transfer pathways in photosynthesis, their conservation in the GreenCut and their intersection with metabolism.....	36
6. Future projects: Translational Photosynthesis towards algal and crop improvement.....	43
7. Perspectives.....	68
8. Bibliography.....	73

1. Curriculum Vitae Dr JOHNSON Xenie, Angela

Address: UMR7265, CNRS-CEA-Aix Marseille University, BVME, BiAM, Saint-Paul-lez-Durance, F-13108, France.

Nationality: French, Australian and British

Home: Married with 2 children

Professional Experience and Funding:

2018: HDR exam. Founding member and deputy director of new “Photosynthesis and Environment” team at BiAM.

2015: “Region PACA Plateform” grant for **ROBO-ALGA** for the partial purchase of a high throughput colony picker and arraying device.

Promoted to E4 position within CEA.

2014: Awarded “**ChloroPaths**” project within the **ANR** Defi 3: Energie sur, propre et efficace. Scientific coordinator. Labellised by GIS Biotech Vert.

2013: **CEA, Cadarache**, France. Researcher engineer position (E3) within Bioenergetics and Biotechnology of Bacteria and Microalgae Lab. Funding: Awarded CNRS INSIS project for “**Algal Domestication**” project.

2012: **Carnegie Institution for Plant Science, Stanford University, Stanford**, California USA. “From the Genome to Photosynthetic Function” project in Prof. Arthur Grossman’s laboratory.

2006-11: **Institut de Biologie Physico-Chimique, Paris, France**. Laboratoire de Physiologie Membranaire et Moléculaire du Chloroplaste (Centre Nationale de la Recherche Scientifique UMR7141). With Jean Alric and Oliver Vallon.

2008: “*In vivo* fluorescence imaging of photosynthetic fluxes”

2006 : “Discovering new nuclear factors implicated in the biogenesis of the photosynthetic complexes.”

2002-5: **Institut National de la Recherche Agronomique, Versailles**, France. Station de Génétique et d’Amélioration des Plantes (SGAP). “Elucidating a new model for branching in *pisum sativum*” in the laboratory of Dr. Catherine Rameau.

Education

2008: Qualification to be a lecturer in French Universities (decision N° 08264156617)

2002: Doctorate of Botany: Botany Department, Plant Biotechnology Centre, La Trobe University, Melbourne, Australia. Funding: Cooperative Research Centre for Molecular Plant Breeding (CRCMPB) and Department of Natural Resources and Environment (DNRE).

Supervisor : Prof. German Spangenberg

1998: Honours in Molecular Genetics (Honours 1A)

Biochemistry Department, University of New South Wales, Sydney, Australia.

Supervisor : Dr. Ian McFarlane: Fungal biosynthetic pathway for 3-NPA

1997: Degree in Molecular Genetics

University of New South Wales, Sydney, Australia

Teaching and Student Projects

2018: Juliane de Graca L3 summer project. APE1 interactions. Presently at UPMC completing her Masters programme.

2016: Marie Chaux doctoral project with Luminy. Co-Supervisor: "Isolation of new dynamic regulators of the photosynthetic apparatus using a genetic approach in the model photosynthetic organism *Chlamydomonas reinhardtii*". Funding French government and ChloroPaths. Awarded best presentation at SFPhi conference 2018. Presently ATER at AMU.

2015: Marie Chaux M2. Co-supervisor. Conserved phosphatase CrPBCP has activity to dephosphorylate core proteins and antennas of PSII but with a different specificity than Arabidopsis in *Chlamydomonas reinhardtii*. Funding CEA and Luminy. Mentionne tres bien, placed second for her year. Awarded Bourse de Ministere. Organised visit over summer to Geneva to work with a specialist in phosphorylation of antenna proteins.

2013 – 2017: Fred Chaux PhD thesis. Co-supervisor. Etude des mécanismes de dissipation de l'excès d'énergie au cours de la photosynthèse chez la microalgae, *Chlamydomonas reinhardtii*. Funding CEA-tech. Currently Post-doctorate at IBPC, Paris.

2012 - 2016 (2012-2013 during my visit): Tyler Witkopp PhD. Thesis project at Stanford in Arthur Grossman's group at the Carnegie Institution of Science : Characterisation of Novel Photosynthetic mutants from the GreenCut. Funding : NSF. PhD completed 2016. Post-doctorate position at Salk Institute

2009 – 2011: Laura Houille-Vernes. Thesis project in the UMR7141 group at IBPC, in the continuation of the Integrative Biology and Physiology course at University Paris 6: Isolation of Novel Photosynthetic Mutants in Alternative Electron Pathways. Funding: Region Ile-de-France. Thesis completed. Consultant with Areva.

2011 (June-August): Alexandre Fagnan: a student of the national school for Chemistry, Biology and Physics, (ENCPB) level BTS (Brevet de technicien supérieur) in biotechnology,

internship was undertaken at the IBPC in the UMR7141. Presently continuing his studies, he returned January-February 2012 to continue his internship.

2008 (October): Maxim Szambien: a fifth year student, specializing in Plant Science at the University Paris 6. This technical project was carried out at the IBPC, Paris in the UMR7141. Presently he is a European project manager assistant at Euroquality. Presently chief assistant at GIS Biotechnology Vert.

2007 (September): Guillaume Vandystadt an engineering student chose the UMR7141 group at the IBPC, Paris to carry out a compulsory project in scientific design (PAMS). Mining engineer with Total. Presently, working in finance, London.

2002-2003 (September): Idriss Aouriri. Masters student in Agricultural Technique with a major in Plant Improvement. University Blaise-Pascal, Clermont-Ferrand, project was undertaken in the Rameau group at INRA: Phenotyping and Mapping of 3 *dor* mutants in *pisum sativum*. Presently, Director general of Ecovi, S.A.S.

2002-2005 (June- August): Mentoring of summer students (First and second year, L1 et L2) project was undertaken in the Rameau group at INRA. This work made up part of the objectives for the European Union GLIP.

Seminars in “Photosynthesis” at Munster University (2012) and “Photobiology” at University Paris 6 (2010).

Fourth Year course Eukaryotic Microbiology at University Paris 7 Denis Diderot 30 hours (2011).

First Year course Plant Ecophysiology and Biology at the University of La Trobe, Melbourne: 2 sessions, 120 hours. (1998-2000).

Third year course “Plant Biotechnology” at the University of New South Wales, Sydney: 60 hours (1997).

Member of the Jury and committees for PhD :

1. Laura Dimnet, “Comité de thèse” June 2016
2. Louis Dumas, “Comité de these” September 2016
3. Serena Flori, PhD Jury examiner September 2016
4. Aurelie Crespin, PhD Jury examiner December 2017

Organising Committee for SFPhi French Society of Photosynthesis since 2015

Reviewer

FRS : Belgian National Research Organisation

NWO : Netherlands Organisation for Scientific Research

FCT : Portuguese Research Organisation

Czechoslovakian Research Org.

Journal of Plant Physiology ; Journal of Phycology ; PLOSONe ; Plant Journal ; BBA

Algal Research ; Photosynthesis Research ; Plant Physiology ; JoVE ; Philosophical Transactions B ; Physiologia Plantarum ; Frontiers in Plant Science.

Oral Presentations

- **18th International Conference on the Cell and Molecular Biology of Chlamydomonas, Washington D.C. June 2018.** *Linking metabolism to photosynthesis regulation using Rubisco-less mutants of Chlamydomonas.*
- **EFOR network conference, Algal Session, Genomic and Metabolic Engineering, Paris 2017.** *Using Chlamydomonas as the vehicle to understand who is the driver in the photosynthetic yields.*
- **CaLIPSO Mari Curie ITN Workshop, Les Diablerets, Suisse, 2016.** *Regulation at the interface between the photosynthetic electron transfer chain and metabolism*
- **Journées de la Photosynthèse: Société Française de la Photosynthèse, Paris 2015.** *Using Rubisco mutants to explore links between metabolism and the photosynthetic electron chain.*
- **3rd DSV PhD Students Meeting, Pourquerolles, 2014.** *Using Rubisco mutants to understand the many varied processes at work in Chloroplasts.*
- **Reunion des Chefs de DSV, CEA, Cadarache, 2013.** *Towards understanding and redesigning photosynthesis, targeted selection of mutants in Chlamydomonas reinhardtii.*
- **Carnegie Institute of Washington, Stanford University, 2012.** *The greencut mutant, cpld49 is at the intersection between metabolism and biogenesis of the photosynthetic machinery.*
- **Gordon Research Conference on Photosynthesis, Davidson College, North Carolina, 2011.** *Does chlororespiration control redox homeostasis in the photosynthetic cell?*
- **ISCGGE conference, Dublin, 2010.** *MRL1 is a conserved factor required for RuBisCO biogenesis.*
- **Fondation Pierre Gilles de Gennes pour la Recherche : Work Shop, Paris, 2010.** *Fluorescence digital video imaging of in vivo metabolic activity.*
- **Journées de Photosynthèse, Société Française de la Photosynthèse, Paris, 2009.** *MRL1 is a conserved factor regulating RubisCO in both green algae and higher plants.*
- **International Chlamydomonas Conference, Giens, 2008.** *Molecular Toolbox : Gene Hunting in Chlamydomonas.*
- **Open Day, Institute Jean-Pierre Bourgin, Versailles, 2005.** *Ramification chez le Pois. Révélation d'un nouvel modèle.*
- **ComBio, Canberra, 2001.** *Fructan Biosynthesis in the Temperate Grasses.*
- **Molecular Breeding of Forage and Turf Grasses, Melbourne, 2000.** *Manipulation of Fructan Biosynthesis in Transgenic Grasses.*
- **CRCMPB Annual Research Meeting, Adelaide University, 1999.** *Manipulation of Fructan Biosynthesis in Transgenic Grasses. Awarded « Best Student Presentation ».*
- **2nd CSPP Workshop, Melbourne, 1998.** *Manipulation of Fructan Biosynthesis in Transgenic Grasses.*

2. List of Publications

1. Brzezowski P, Ksas B, Havaux M, Grimm B, Chazaux M, Peltier G, Johnson X and Alric J (2018) *Chlorophyll biosynthesis is hard wired to electron transfer in Chlamydomonas* (under review Communications Biology)
2. Dumas L, Zito F, Auroy P, Johnson X, Peltier G, Alric J. (2018) *Structure-function analysis of chloroplast proteins via random mutagenesis using error-prone PCR*. **Plant Physiol.** 177(2):465-475
3. Wittkopp TM, Saroussi S, Yang W, Johnson X, Kim RG, Heinnickel ML, Russell JJ, Phuthong W, Dent RM, Broeckling CD, Peers G, Lohr M, Wollman FA, Niyogi KK, Grossman AR. (2018) *GreenCut protein CPLD49 of Chlamydomonas reinhardtii associates with thylakoid membranes and is required for cytochrome b6 f complex accumulation*. **Plant J.** 94(6):1023-1037.
4. Jokel M, Johnson X, Peltier G, Aro EM, Allahverdiyeva Y. (2018) *Hunting the main player enabling Chlamydomonas reinhardtii growth under fluctuating light*. **Plant J.** 94(5):822-835.
5. Dumas L, Zito F, Blangy S, Auroy P, Johnson X, Peltier G, Alric J. (2017) *A stromal region of cytochrome b(6)f subunit IV is involved in the activation of the Stt7 kinase in Chlamydomonas*. **Proc Natl Acad Sci U S A.** Oct 24. pii: 201713343. doi: 10.1073/pnas.1713343114. [Epub ahead of print] PubMed PMID: 29078388.
6. Alric J, Johnson X. (2017) *Alternative electron transport pathways in photosynthesis: a confluence of regulation*. **Curr Opin Plant Biol.** Jun;37:78-86.
7. Dumas L, Chazaux M, Peltier G, Johnson X, Alric J. (2016) *Cytochrome b 6 f function and localization, phosphorylation state of thylakoid membrane proteins and consequences on cyclic electron flow*. **Photosynth Res.** Sep;129(3):307-20.
8. Chauv F, Johnson X, Auroy P, Beyly-Adriano A, Te I, Cuiné S, Peltier G. (2016) *PGRL1 and LHCSR3 Compensate for Each Other in Controlling Photosynthesis and Avoiding Photosystem I Photoinhibition during High Light Acclimation of Chlamydomonas Cells*. **Mol Plant.** Sep 28.
9. Douchi D, Qu Y, Longoni P, Legendre-Lefebvre L, Johnson X, Schmitz-Linneweber C, Goldschmidt-Clermont M. (2016) *A nucleus-encoded chloroplast phosphoprotein governs expression of the photosystem I subunit PsaC in Chlamydomonas reinhardtii*. **Plant Cell.** May;28(5):1182-99.
10. Yang W, Wittkopp TM, Li X, Warakanont J, Dubini A, Catalanotti C, Kim RG, Nowack EC, Mackinder LC, Aksoy M, Page MD, D'Adamo S, Saroussi S, Heinnickel M, Johnson X, Richaud P, Alric J, Boehm M, Jonikas MC, Benning C, Merchant SS, Posewitz MC, Grossman AR. (2015)

Critical role of Chlamydomonas reinhardtii ferredoxin-5 in maintaining membrane structure and dark metabolism. Proc Natl Acad Sci U S A. Dec 1;112(48):14978-83.

11. Steinbeck J, Nikolova D, Weingarten R, Johnson X, Richaud P, Peltier G, Hermann M, Magneschi L, Hippler M. (2015) *Deletion of Proton Gradient Regulation 5 (PGR5) and PGR5-Like 1 (PGRL1) proteins promote sustainable light-driven hydrogen production in Chlamydomonas reinhardtii due to increased PSII activity under sulfur deprivation. Front Plant Sci.* Oct 27;6:892.
12. Chauv F, Peltier G, Johnson X. (2015) *A security network in PSI photoprotection: regulation of photosynthetic control, NPQ and O₂ photoreduction by cyclic electron flow. Front Plant Sci.* Oct 15;6:875.
13. Wang F, Johnson X, Cavaiuolo M, Bohne AV, Nickelsen J, Vallon O. (2015) *Two Chlamydomonas OPR proteins stabilize chloroplast mRNAs encoding small subunits of photosystem II and cytochrome b(6)f. Plant J.* 2015 Jun;82(5):861-73.
14. Dang KV, Plet J, Tolleter D, Jokel M, Cui n  S, Carrier P, Auroy P, Richaud P, Johnson X, Alric J, Allahverdiyeva Y, Peltier G. (2014) *Combined increases in mitochondrial cooperation and oxygen photoreduction compensate for deficiency in cyclic electron flow in Chlamydomonas reinhardtii. Plant Cell.* 26(7):3036-50.
15. Johnson X, Steinbeck J, Dent R.M, Takahashi H, Richaud P, Ozawa S-I, Houille-Vernes L, Petroutsos D, Rappaport F, Grossman AR, Niyogi KK, Hippler M and Alric J. (2014) *PGR5-mediated cyclic electron flow under ATP- or redox-limited conditions: A study of Δ ATPase pgr5 and Δ rbcl pgr5 mutants in Chlamydomonas reinhardtii. Plant Physiol.,* 165,438-452.
16. Johnson, X, Alric, J. (2013) *Central carbon metabolism and electron transport in Chlamydomonas reinhardtii, metabolic constraints for carbon partitioning between oil and starch. Eukaryot. Cell,* 12 (6): 776-793.
17. Johnson, X, Alric, J. (2012) *Interaction between starch breakdown, acetate assimilation and photosynthetic cyclic electron flow in Chlamydomonas reinhardtii. J. Biol. Chem.,* 287, 26445-26452.
18. Houille-Vernes L, Rappaport F, Wollman FA, Alric J, Johnson X. (2011) *Plastid Terminal Oxidase 2 (PTOX2) is the major oxidase involved in chlororespiration in Chlamydomonas. Proc Natl Acad Sci U S A.* 108(51):20820-5.
19. Johnson, X. (2011) *Manipulating RuBisCO accumulation in the green algae, Chlamydomonas reinhardtii. Plant Mol Bio.* 76(3-5):397-405.

20. Johnson X, Houille-Vernes L, Alric J. (2011) *Screening and studying photosynthetic mutants: basics and beyond*. In **Bioenergetics**, Nova Publishers, New York, USA. pp239-244.
21. Grossman A, Karpowicz S, Heinnickel M, Dewez D, Hamel B, Dent R, Niyogi K, Johnson X, Alric J, Wollman FA, Li H, Merchant S. (2010) *Phylogenomic analysis of the Chlamydomonas genome unmasks proteins potentially involved in photosynthetic function and regulation*. **Photosynth Res.** 106(1-2):3-17.
22. Johnson X, Wostrikoff K, Finazzi G, Kuras R, Schwarz C, Bujaldon S, Nickelsen J, Stern D, Wollman FA and Vallon O. (2010) *A conserved PPR protein is required for stabilization of rbcL mRNA in Chlamydomonas and Arabidopsis*. **Plant Cell.** 22(1):234-48.
23. Johnson X, Vandystadt G, Bujaldon S, Wollman FA, Dubois R, Roussel P, Alric J, Béal D. (2009) *A new setup for in vivo fluorescence imaging of photosynthetic activity*. **Photosynth Res.** 102(1):85-93.
24. Bailleul B, Johnson X, Finazzi G, Barber J, Rappaport F, Telfer A. (2008) *The thermodynamics and kinetics of electron transfer between cytochrome b6f and photosystem I in the chlorophyll d-dominated cyanobacterium, Acaryochloris marina*. **J Biol Chem.** 283(37):25218-26.
25. Johnson X, Kuras R, Wollman FA, Vallon O. (2007) *Gene Hunting in Chlamydomonas*. In **Photosynthesis Energy from the Sun**. J.F. Allen, E. Gantt, J.H. Golbeck & B. Osmond (eds.) Springer. pp1099-1103.
26. Johnson X, Bouchez D. (2007) *The model species, Arabidopsis thaliana*. In **Functional Plant Genomics**. JF Morot-Gaudry, P Lea, JF Briat, (eds). Science Publishers, Enfield, NH, USA. pp 385-396.
27. Johnson X, Brcich T, Dun E, Goussot M, Haurigné M, Beveridge CA and Rameau C. (2006) *Branching genes are conserved across species. Genes controlling a novel signal in pea are coregulated by other long-distance signals*. **Plant Physiol.** 142(3):1014-26.
28. Johnson X, Lidgett A, Chalmers J, Guthridge K, Jones L and Spangenberg G. (2003) *Isolation and characterisation of an invertase cDNA from perennial ryegrass (Lolium perenne)*. **J. Plant Physiol.** 160:903-11.
29. Chalmers J, Johnson X, Lidgett A and Spangenberg G. (2003) *Isolation and characterisation of a sucrose: sucrose 1-fructosyltransferase gene from perennial ryegrass (Lolium perenne)*. **J. Plant Physiol.** 160:1385-91.

30. Lidgett, A., Jennings, K., Johnson, X., Guthridge, K., Jones, E. and Spangenberg, G. (2002) *Isolation and characterisation of a fructosyltransferase gene from perennial ryegrass (Lolium perenne)*. **J. Plant Physiol.** 159 : 1037–1043.

Patent

International Patent PQ8155. *Fructosyltransferase homologues from Ryegrass (Lolium) and Fescue (Festuca) species*, Filed 13th December, 2002.

3. Plants, genetics, domestication and green energy: a brief explanation of my scientific path

Photosynthetic organisms have the peculiarity of being able to feed themselves with air and sunlight. In the case of plants they cannot move, another curiosity for a biological organism. My scientific experience in plants, has led me to realize the importance of the molecular processes involved in development and in response to external signals that are particularly important for these phototrophic and sessile organisms. Highly developed signaling has allowed photosynthetic organisms to acclimate and then adapt to their environment resulting in the colonization of the planet by phototrophic organisms.

As a molecular geneticist, my first port of call has always been to start by searching for the genetic basis of a phenotypic trait : either by homology to a known gene in another species or mutation in a gene responsible for a given phenotypic trait or pathway of interest. Using either of these genetic techniques, reverse or forward, and with the advent of genomics, what appears clearly is that photosynthetic organisms have closely retained the genetic information and the functional integrity of important pathways throughout millions of years of evolution as well as through the path from unicellularity to multicellularity. It's fascinating to note that similar genetic lesions can cause very different phenotypic traits in different organisms, for example an absence of the plastid terminal oxidase in chloroplast thylakoids, PTOX, results in colorless tomatoes or variegated Arabidopsis leaves, however, at the molecular level the function of the enzyme stays the same. My aim has persistently been to contrast the conservation of functional activity and role of conserved proteins against their recruitment for a role in response to the particular environment experienced by that organism or a particular development stage of the plant.

Photosynthesis is the process whereby an organism has the capacity to fix its own inorganic carbon and transform this carbon into carbohydrate by generating energy using water and sunlight alone. Both the carbohydrate generated and the energy to fix the carbon must be tightly regulated to achieve an energetic homeostasis. There is undoubtedly a trade-off between the resources allocated for growth, reproduction, stress resistance and energy

storage that the wild organism must practice according to environmental cues. The domesticated organism has a more limited set of cues because irrigation and fertilization curbs potential stress arising from limitations to water, nutrients and space. This stimulates, in turn, a maximal growth strategy. Controlled culture conditions either in the field or the photobioreactor also allows us a window to search for a desired agronomic trait, by stimulating the dominance of a desired trait we reduce the organism's palette of available resources to respond to a stress, the trade off for increased productivity. I have been involved in projects where we have set an objective for the improvement of a desired trait : soluble carbohydrate levels in leaves of gramineae, plants with more axillary meristems leading to higher structural rigidity and more fruiting, algae capable of using fixed carbon alone to actively divide while storing lipids.

During my Masters year, I supervised practical laboratory sessions in plant genetic engineering and metabolism and during my PhD, I was able to teach ecology and plant biology, focusing on the origin, distribution and adaptation of flora to a given environment. Over the past 15 years I have had the opportunity to work closely with students from bachelor level to PhD level. Since 2011 I have helped supervise, Laura Houille-Vernes, Tyler Witkopp, Fred Chaux and Marie Chaux. For the last two I am official co-supervisor. For the first three they have gone on towards scientific careers both in industry and in academia. Helping the young researcher to undertake experiments, organise their work and prepare their data so that we can conceptualise their observations for publication presently represents a substantial proportion of my time. Although challenging, guiding and teaching students is rewarding work.

In my research activity, I have been interested in subjects that may seem very varied, but which always address the question of the plasticity of biological systems with the same integrative biology approach. I have used molecular biology, genetics and plant physiology to detail the pathways of metabolic syntheses such as those of water-soluble carbohydrates in grasses (thesis), multifactorial signals regulating branching in higher plants (post-doc INRA), the factors regulating the biogenesis of the photosynthetic apparatus and the proteins involved in photosynthetic alternative electron pathways (post-doctorate at the CNRS, Carnegie Institute Stanford and CEA). This very varied background was often driven by my

desire as a young scientist to learn new techniques and to familiarise myself with a different scientific culture. A way of doing this was the radical refocusing of my energies onto a new model species which allowed me, a number of times, to immerse myself in a whole new subject with a different set of intellectual challenges each time. When I arrived in 2006 at the chloroplast membrane and molecular physiology lab at the IBPC, specialised in the integrative study of photosynthesis, I realised that this was the subject that I had been searching for because the study of photosynthesis integrates just about every type of scientific technique and question possible. The only other scientific pursuit that resembles the study of photosynthesis in its diversity is neuroscience!

In nature, photosynthetic metabolism faces continuous fluctuations of energy input that are intrinsic to natural sunlight. As a consequence, photosynthetic organisms have developed a wide spectrum of regulatory mechanisms that coordinate light capture, generation of reducing power and protons and metabolism. These feedback and forward mechanisms that control photosynthesis are presently my main focus of investigation. My aim is to decipher to what extent they can be manipulated to improve photosynthetic efficiency. Mechanisms of interest include non-photochemical quenching, alternative electron pathways and redox control of metabolism.

Chapter 4. The Teeth Cutting Experiences

Part A. Soluble carbohydrates in monocotyledonous plants

Thesis Studies, Plant Biotechnology Centre, Department of Primary Industries and La Trobe University, Melbourne, Australia: Isolation and Functional Analysis of the Fructosyltransferase Homologue, LpFT2, in Perennial Ryegrass

My work focused on the study of the biosynthesis of fructans in English ryegrass (*Lolium perenne*). Fructans are soluble sugars stored by grasses (Poaceae) and can represent between 75 and 90% of the carbon reserve in vegetative organs. They are polymers of fructose residues that form complex chains and their synthesis involves several biosynthetic enzymes. Fructans are involved in the regrowth dynamics as well as in the regulation of the water and osmotic equilibrium thanks to the modulation of the ratio polyfructans / oligofructans on the one hand and on the other hand thanks to their capacity to trap water molecules and to protect membrane systems [1]. As soluble sugars, they play a role in forage quality by stimulating the proliferation of rumen microorganisms and also increasing heterolactic fermentation in silage. They are also associated with mechanisms of resistance to stress such as cold or drought [2,3].

In my thesis work, I identified and cloned homologous fructosyltransferase (FT) genes whose products are involved in the fructan biosynthesis pathway in English ryegrass [4,5]. The aim was that these genes would be used as a tool for MAS (Marker Assisted Selection). The long-term objectives of this work were to generate transgenic ryegrass plants with altered fructan biosynthesis in order to improve their nutritional value as well as their resistance to stress. The transformation of grasses is based on the development of cell suspensions capable of regenerating into fertile plants. It is also based on the morphogenic competence of individual cells. Thus, this technique requires the screening of a large number of genotypes on the basis of their performance in culture, their transformation efficiency as well as their capacity to restart after transformation. As far as biolistic transformation is concerned, it has been optimized in the laboratory [6]. The constant search for genotypes favorable to transformation was a work in which all the students were involved.

Plants and microorganisms synthesise fructans from a sucrose precursor in the vacuole. Several categories of fructans are distinguished according to the type of bond present between the fructose units. The structure of fructans in ryegrass is very complex compared to the inulin structure of fructans present in Jerusalem artichoke tubers or chicory-endive roots [1]. Based on known structures of *Lolium perenne* fructans and on current knowledge of the enzymes involved in their metabolism in monocotyledons and dicotyledons [7,8], we created a model for the synthesis of *Lolium perenne* fructans (see Figures 1 and 2). This model is based on a set of four enzymes that are 1-SST, 1-FFT, 6G-FT and 6-SFT (or 6-FFT):

- 1-SST (1-sucrose: sucrose fructosyltransferase) is responsible for the synthesis of 1-kestotriose from sucrose,

1-FFT (1-fructan: fructan fructosyltransferase) catalyzes the formation of β (2-1) bonds,

6-GFT (6-glucose fructosyltransferase), condenses two molecules of 1-kestotriose at the glucose level,

6-SFT (6-sucrose: fructan fructosyltransferase) or 6-FFT (6-fructan: fructan fructosyltransferase) catalyzes the formation of β (2-6) bonds, predominant in *Lolium perenne*.

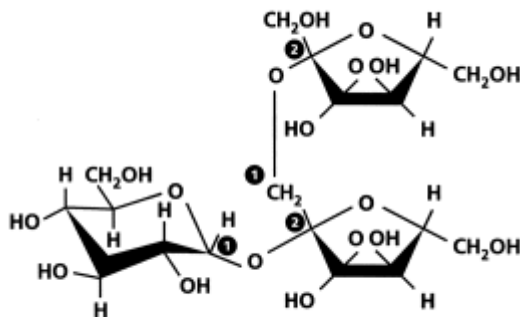

Figure 1. 1-Kestotriose, (2-1)-linked- β -D-fructose linked with sucrose. Molecule precursor of the inulin series.

One of the challenges in identifying fructosyltransferases is the presence of enzymes that are extremely similar in sequence and catalytic sites: invertases and fructans exohydrolases (FEH). The major activity of invertases is the hydrolysis of sucrose and that of FEH is the hydrolysis of fructan. It has also been shown that under certain conditions these two enzymes can also carry out the inverse activity and polymerize fructose [9]. Thus, functional characterization *in vitro* or *in vivo* was necessary to verify the activity of the enzymes whose genes I isolated. During my thesis, I also developed a robust technique to distinguish the types of major enzymatic activities by analyzing the effects of these enzymes on their

substrates, sucrose and fructan. To isolate the genes of fructosyltransferases I screened a phage library containing *L. perenne* cDNAs (4-week-old shoots grown in the dark) using a 6-SFT barley probe. Twelve positive clones were recovered and eleven were successfully transferred to pBluescript. After sequencing the eleven clones, four individual cDNAs were isolated, only two of which were complete, that we named LpFT1 (1947bp 3'UTR included) and LpFT2 (2342bp 3'UTR included). The proteins encoded by these four cDNAs showed strong homology with FT and invertases and carried characteristic motifs of these enzymes. The complete sequences of the two partial cDNAs were obtained using a genomic library and a 5'RACE library. The gene structure of LpFT2 has two points of interest; A 9-nt mini-exon that codes for the sugar-box, the sucrose-binding site, and a destabilizing motif in the 3'UTR already characterized in the response to sucrose concentration in rice [10]. The *LpFT1* and *LpFT2* genes each had a single transcript (Northern blot) an important result because ploidy is variable in ryegrasses. Their level of expression is high in young shoots, young roots and mature leaf sheath, which are regions within which soluble sugars are concentrated. On the other hand, their level of expression was low in mature leaves and roots. The *LpFT1* and *LpFT2* probes were also capable of hybridizing with RNAs extracted from other grasses, suggesting conservation of these genes between species. Southern blot analysis using the genomic DNA of the doubled haploid proved that *LpFT1* and *LpFT2* were single copy genes. RFLP mapping analysis localized *LpFT1* to linker group 7 and *LpFT2* to linker group 6. Comparative genetic analysis using barley 6-SFT as a putative ortholocus showed that the synteny was retained for *LpFT1* suggesting a common evolutionary origin for both genes. In contrast, the syntenia was not conserved in the LpFT2 region. Moreover, LpFT2 was located in a region of the genome with known QTLs that influence the amount of leaf soluble sugars in *Lolium* species.

Methylotrophic yeast, *Pichia pastoris* and tobacco (*Nicotiana tabacum*) are fructan-free organisms that were used as heterologous systems to test the functional expression of LpFT1 and LpFT2. *P. pastoris* was chosen for the production and analysis of the activity of LpFT1 and LpFT2, on the one hand for its glycosylation activity and on the other hand for its absence of sucrolytic activity. Analysis in SDS-PAGE (12% acrylamide) showed that the proteins were excreted in the medium at a high concentration and a high purity level. In vitro enzymatic tests with LpFT1 and LpFT2 were carried out at 27 ° C. and pH 5.7 (vacuolar

pH). Different substrates were tested to determine the type of activity of these two enzymes. The products of the incubations were filtered and analyzed by chromatography (High pH Anion Exchange Chromatography with Pulsed Amperometric Detection (HPAEC-PAD)) using an isocratic gradient. LpFT1 in the presence of sucrose predominantly produces 6-kestose (product of the condensation of a fructose on β 2-6 sucrose) and monosaccharides (mainly glucose). Thus, fructosyltransferase and invertase activity was shown. When incubated with fructans with a higher degree of polymerization (DP), LpFT1 showed little exohydrolase activity; Thus LpFT1 was characterized as a 6-SST [5]. LpFT2 produced monosaccharides and small amounts of 1-kestose. It also showed FEH activity with DP3-6 fructans; Thus LpFT2 was characterized as an invertase with FEH activity [11]. The transformation of tobacco protoplasts with the LpFT1 and LpFT2 genes fused to a CaMV35S promoter and co-transformed with the npt2 gene (to select transformants on kanamycin) generating fertile plants without observable phenotype. Analysis of the soluble sugars profiles showed no difference between the wild type and the plants which express LpFT1 and 2 (Northern Blot). These results led us to conclude either that the foreign proteins were degraded or that the amounts of fructan or monosaccharide produced were not sufficient to observe a difference between the transformed and untransformed plants. So this system was dropped for functionality testing.

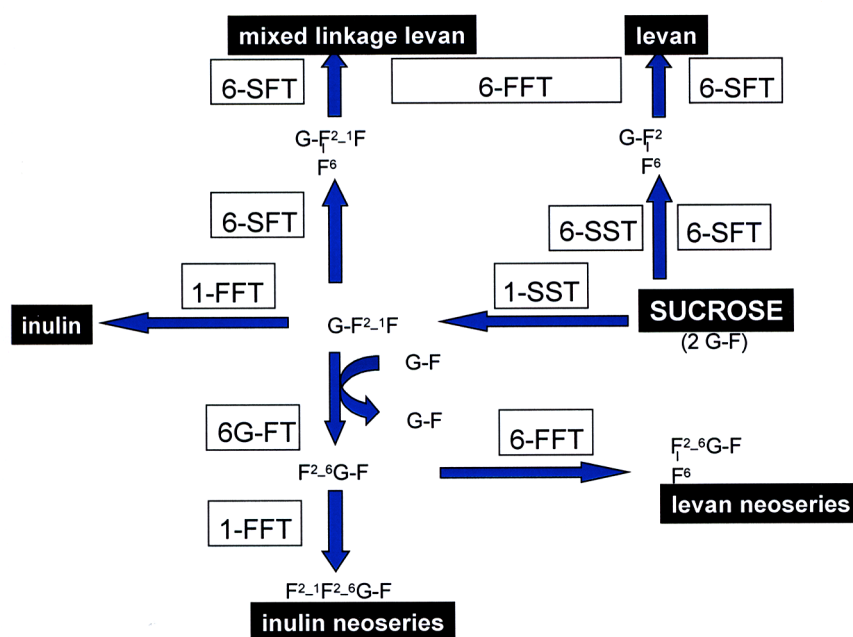

Figure 2. Biosynthesis of fructan in *Lolium perenne*

Project Conclusions and Perspectives

In summary, during my thesis I isolated 4 homologous genes that code for FT and FEH / invertase from the same cDNA library. For this I set up a heterologous system to identify the activities of homologous genes of FT. The identification and characterization of these genes indicate that their spatio-temporal expression is identical suggesting that they may work in the same pathway(s). The mapping analysis showed a synteny between LpFT1 with Hv6SFT, which is conserved in grasses. LpFT2 is located in a region of the genome with QTLs affecting the amount of soluble sugars in *Lolium* leaves. Moreover, in LpFT1, the predicted presence of a motif in the 3' untranslated region of the RNA is observed which destabilizes it in the presence of high concentrations of sucrose. It can therefore be hypothesized that the co-regulation of these two genes could be essential for the production of fructans. In particular, the FEH / invertase activity of LpFT2 could reduce the vacuolar concentration of sucrose, thus allowing the stabilization of the LpFT1 messenger RNA. The accumulation of fructosyltransferase would then allow the production and accumulation of fructan. This work resulted in three publications [4,5,11] and one patent [12]. In order to analyze products of the activity of these enzymes, I developed an original system of analysis of soluble sugars, which is still used in the laboratory.

Twenty years after the conception of this project the first transgenic ryegrass plants have been patented and published [13]. The breakthrough in the generation of these transgenics consisted of increasing the expression of the FTs in leaf blades by using strong photosynthetic promoters (RbcS from Wheat) to assure their expression in photosynthetic tissues rather than roots, sheafs or immature leaf blades where their expression is usually the highest. The resulting plants have the desirable agronomic traits that had been proposed at the beginning of my project (figure 3). The laboratory also improved the homologous system in tobacco by doing direct assays by agrobacterium mediated injection into mature leaves and then measuring soluble carbohydrates for increases in sucrose, kestose and longer chain fructans. The 1-SST enzyme used for the transgenics was the first cDNA that we isolated during my thesis so I am very happy to see the positive outcome of this work due to solid perseverance by the team at DPI.

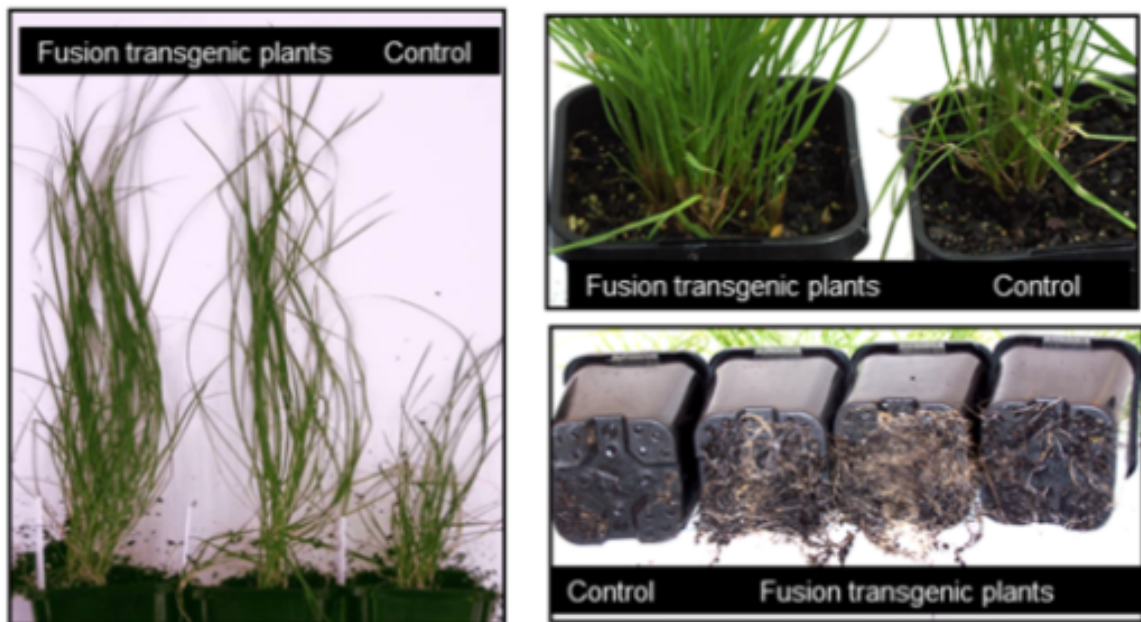
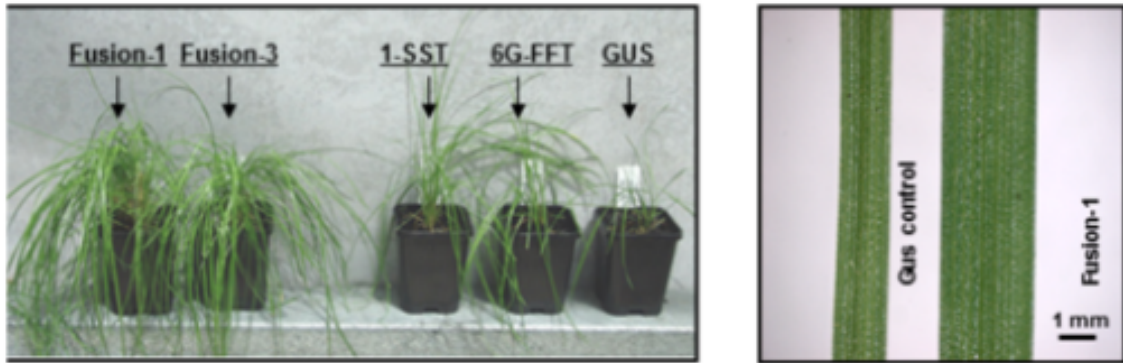

Figure 3. Transformed *L. perrene* plants expressing 1-SST and 6G-FFT enzymes from photosynthetic promoters in leaf blades show higher growth phenotypes, denser and darker green leaves and better root networks.

Part B. Branching and long distance signaling in pea *rms* mutants

Post-doctoral position, Station of Genetics and Plant Improvement in the team of Catherine Rameau, INRA Versailles, around a Model of Branching in Peas

The INRA Pea Architecture team in Versailles focuses on the study of branching and flowering using pea as a model system. This laboratory has brought together the most extensive collection of branching mutants of the same species. All these mutants were characterized physiologically in collaboration with Christine Beveridge of the University of Queensland, the genetic characterization having been carried out by the team of Catherine Rameau in Versailles. Five hyper branched *ramosus* (*rms*) mutants were identified to have little or no pleiotropic effect in pea (as opposed to many other categories of branched mutants that have multiple phenotypic traits) (figure 4). Another 3 mutants (*rms* 6-8) have mildly pleiotropic characters with the hyper branching. Studies carried out on these *rms* strains have led to the conclusion that the genes involved were mainly responsible for controlling the growth of axillary buds [14]. A second mutagenesis was carried out on two of these strains (*rms*3 and *rms*4). This mutagenesis allowed the production of peas whose buds remained dormant (*dor*) during the vegetative growth phase, thus suppressing the *rms* phenotype. These *dor* lines allowed the study of the mechanism involved in the activation of the axillary buds.



Figure 4. Wildtype (left) and hyper branching mutant, *rms1* (right).

One of the advantages in using pea as a model system is that it allows the study of architecture thanks to its stature which facilitates the type of techniques we were using at the time such as phenotyping and measurement of buds, grafts to determine the movement of the signals, hormone applications and extractions. The existence of relatively non-pleiotropic hyper branched mutants in other species, which at the time were only hypothesised to correspond to *rms* mutants, facilitated the molecular characterization of the pea RMS genes. At the time, little genomic data was available for the highly repetitive and massive 4300 Mb genome of this leguminous species and the medicago genome was only in a draft stage. Four mutants in Arabidopsis (*max1-4*), three in petunia (*dad1-3*), and three in rice (*htd1-3*) were able to show that homologues in peas and petunia AtMAX4 (which codes for Carotenoid Cleavage Dioxygenase 8 (CCD8) in Arabidopsis) are respectively RMS1 and DAD1 indicating that the pathway was conserved across species [15,16].

The apex actively inhibits branching in the wild-type strain. Auxin, derived from the apex that moves down the stem, has been identified as the main regulator of axillary bud growth suppression [17]. Cytokinins, produced in roots and carried to the stem, are essential for bud growth. Cytokinins can be used to stimulate branch growth by direct application to buds. However, in *rms* mutants, the levels of expression of auxin and cytokinins are not significantly modified [18,19] and the application of these hormones has no effect on branching in contrast to the wt. By performing grafts between wt roots and *rms* mutant shoots and the reciprocal graft, it was shown that RMS1 and RMS5 are involved in the production of a root-shoot inhibitory signal along the branch, that RMS3 and RMS4 are involved in receiving the signal at the level of the bud and that RMS2 acts as a shoot-root feedback signal (see Figure 5).

During my stay in the laboratory, I cloned the genes PsMAX2 and PsMAX3 to verify that these were the altered *RMS4* and *RMS5* genes in the mutant's *rms4* and *rms5*. The genes were cloned by a "candidate gene" approach. For *RMS4*, a combination of degenerate primers corresponding to the sequences available in Arabidopsis and Medicago was employed. Several cycles of RACE 3' and 5' permitted a "walk" along the cDNA and thus the identification of the complete gene. For *RMS5*, degenerate primers corresponding to conserved regions of several species were used to isolate a 420 bp fragment that was later

used to screen a pea BAC library. A positive clone was identified and sequenced to obtain the complete genomic sequence of RMS5. The cDNA was amplified from the epicotyl mRNAs to define the intron / exon boundaries. Functional homology was confirmed by the co-localization in the pea genome and the presence of mutations in the PsMAX2 gene of 6 mutant *rms4* independent lines. Functional homology between PsMAX3 and RMS5 was similarly confirmed by the sequencing of PsMAX3 from the 3 *rms5* lines identifying mutations leading to the observed abnormal phenotypes.

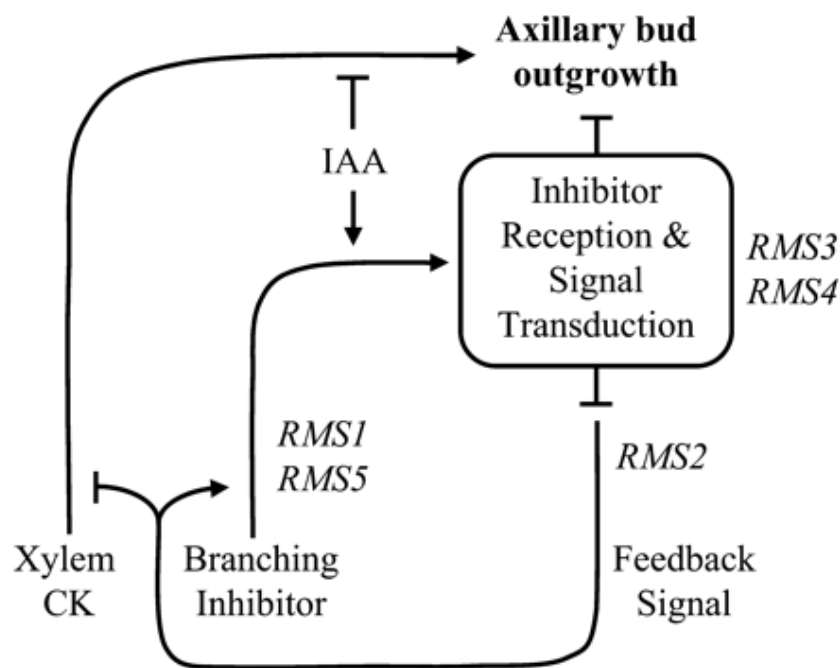

Figure 5. Simplified model of control of branching in peas, conserved in other species. The growth of the axillary buds depends on the auxin / cytokinin ratio. RMS1 and RMS5 act as auxin secondary messengers, while RMS3 and RMS4 are involved in signal perception. RMS2 is involved in a feedback loop of these signals [20].

Physiological studies in pea and *Arabidopsis* indicate that RMS4 is a F-box-type protein (associated with targeted ubiquitination) as a receptor in the inhibition of branching [21-24]. Studies of the expression of *RMS4* RNAs were performed in wild type plants. The presence of these RNAs was detected throughout the plant but with greater abundance in the leaves stipules. No change in *RMS4* expression was observed in mutant's *rms1*, *rms2*, *rms3* and *rms5* both during development and in response to decapitation in the presence or absence of auxin.

The expression of RMS4 in the roots was studied more in depth by graft studies. By comparing all the root-shoot reciprocal grafts made between *rms4* and the wild type, I showed that the roots of the *rms4* mutants can significantly inhibit bud growth under "short-day" conditions, decreasing normal branching in the wild type. This result, coupled with data on the expression of *RMS1* in *rms4* mutants, concluded that RMS4 has a role in roots that is associated with control of the root-stem inhibitory signal which has as its limiting factor RMS1 [25]. The proof of high levels of the root-shoot signal in *rms4* roots also provided an excellent tool for the eventual identification of the nature of this molecule [26]

RMS5, as homologue of AtMAX3, encodes CCD7, another enzyme belonging to the carotenoid-derived pathway that is involved in the root-shoot inhibitor signal. Real-time PCR analyzes showed that *RMS5* expression was globally correlated with *RMS1* expression [25]. Foo et al. [20] showed that the expression of *RMS1* in wild plants was greatly decreased in response to decapitation and that the application of auxin after decapitation allowed the levels of expression of *RMS1* to be restored. The conjunction of the results obtained with RMS1 and RMS5 confirms the results of the physiological studies: the root inhibitor / stem signal is the auxin secondary messenger. The variation in *RMS5* expression level observed in the various *rms* mutants, as had already been observed in the case of RMS1, indicates a system of control of the ramification involving the products of all the RMS genes (see figure 4).

The second part of my project was to analyze the *dormant* mutants that were derived from the second mutagenesis carried out on *rms3* and *rms4* and screened for suppression of the hyperbranched phenotype (figure 5). With a DESS student, we mapped the molecular markers of the mutations *dor2* (linking group III) and *dor3* (linking group VI) on the genetic map of the pea. These two mutations proved to be recessive. I continued this work on *dor2rms4* and was able to isolate *dor2* in a simple mutant genetic context. We made a first cross with a wild plant. We grew the plants up to stage F2, and we only kept the unbranched plants. Then we used a CAPs marker designed to differentiate *rms4* from *RMS4* to detect heterozygotes (*RMS4 / rms4*). We then sowed members of the progeny of each of the heterozygotes and we chose the populations whose offspring were unbranched, in order to have a homozygote *dor2* population. These plants were then examined with CAP markers to

detect whether they were also homozygous for *RMS4*. I also continued to screen the mutant populations to find new *dor* candidates. I found three new dormant mutants, more or less severely suppressing the *rms4* phenotype. I started the first cross with *rms4* to purify the lines to analyze them at the stage of BC2F4 (2 backcrosses and 4 self-fertilizations). A phenotypic analysis was undertaken to measure the architectural features of *dor2* and *dor2rms4*, under short day or long day conditions. This study included a detailed analysis of bud size as well as mitotic index. Physiological studies have also been carried out to examine the response of the various mutants to decapitation with or without auxin and cytokinin applications on the buds. We showed in this study that the *dor2* mutants had reduced branching under the conditions of "short days" compared to the wild type. However, as the buds were more developed, I concluded that *dor2* acted in bud growth at a later stage of development relative to the *rms* pathway. To continue the phenotyping of the *dor* mutants and to follow the steps of the bud activation, I designed a number of markers to define the different stages of bud development in collaboration with Dr. Beveridge's group. In order to define more precisely the notion of dormancy, markers to define the stages of the cell cycle in relation to auxin flows at different stages of bud growth were determined.

Project Conclusions and Perspectives

My work on *RMS4* and *RMS5* helped elucidate two essential aspects of the processes of plant branching: 1. I showed that the long distance signaling mechanism that governs the branching process is conserved between species. 2. My molecular analysis contributed to a better understanding of the physiological data that had been obtained in the pea from the previous studies. My contribution to the characterization of the *dor* mutants was the start of a larger project to characterize the interactions between the pathway of inhibition of branching and bud development. I was able to establish that *dor2* acts on the growth of the bud in a stage of later development with respect to the *rms* pathway. The molecular characterisation of DOR proteins is currently underway. During this work I contributed to the generation and cleaning of lines. I also participated in the mapping, and in the generation of simple mutants. I realized their phenotyping using an original approach of genetics and molecular biology. My time in this lab allowed me to significantly improve my knowledge of genetics and techniques commonly used in plant physiology. Over the summer I worked closely with bachelor degree students and I helped supervise a student on DESS. During this

time I also began to be interested in the notion of model species (after having worked on species of agronomic interest) and I participated in writing a review for a book chapter on Arabidopsis as a genomic plant model [27]

A year after I left the lab, this field exploded with the discovery of the nature of the « root shoot signal » as STRIGTOLACTONE (SL) that the group's of Rameau and Beveridge had previously identified as being the product of beta-carotene cleavage by the CCD7/8 enzymes in root plastids. The action of SL interaction with auxin before and after decapitation is shown in figure 6. Slowly but surely over the last 10 years the molecular nature of the whole signaling pathway has been revealed by a concerted effort between those working on Pea and Arabidopsis and those working on Rice, where a large library of dwarf high tilling mutants made an important addition to the missing links of D14 and D53. The pea protein RMS3 is the orthologue of D14 and encodes an α/β hydrolase that cleaves strigolactone and enhances interaction with RMS4 /Max2 - SCF F-box ubiquitin ligase activating complex [28]. RMS2 is AFB4/5 Auxin receptor that mediaes the SL – auxin feedback loop at the level of the bud [29]. The D53 protein encodes the Clp Protease that leads to degradation of as yet unknown bud growth proteins that control bud cell division and interacts with auxin, IAA and gibberellins.

The advantages that each different model species posseses (ie genome and vast molecular tools for Arabdiopsis versus ease of phenotyping and physiology of hormone quantification, decapitation and grafting for Pea, large mutant libraries in rice with ease of phenotyping) as well the very strong competition between the various groups working on branching was the driver for the remarkable progress that has been made on this subject. It is interesting to note that the first publication showing that the *ramosus* pea mutants were implicated in long distance signaling regulating branching was published in 1994. In 2008 the nature of the signal was determined [26], 14 years later. In 2012 the active site of the SL molecule was determined [30] and patents were obtained for their use in agriculture (figure 7). In a similar time frame as for my PhD project, it took around 20 years to see a material deliverable from a fundamental scientific project with an applied aim.

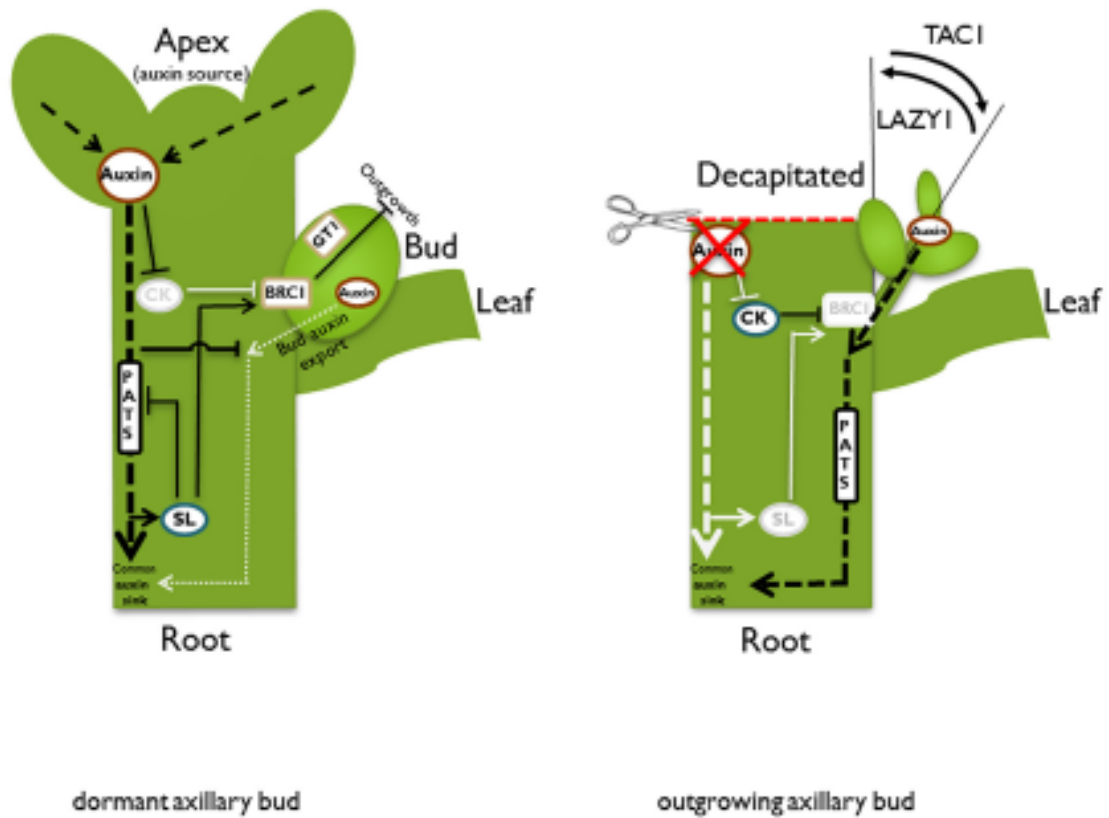

Figure 6. A schematic representation of SL signaling at the level of the bud [31].

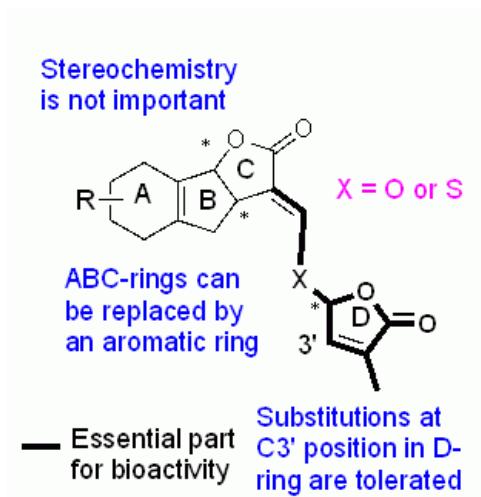

Figure 7. Three patents were submitted in 2016 for analogs of SLs. More than 20 types of active SLs exist *in planta*. These new molecules will be commercialized for agronomic purposes such as fruiting, cambium thickness and structural rigidity.

Part C. Biogenesis of the photosynthetic apparatus in *Chlamydomonas reinhardtii*

Post-doctoral fellow at the Institut de Biologie Physico-Chimique in the Chloroplast Membrane and Molecular Physiology team, directed by Olivier Vallon, Richard Kuras and Francis-André Wollman on 'A Genomic Approach to Nuclear Genes Involved in the Biogenesis of the Photosynthetic Apparatus' ANR blanc 2006.

The biogenesis of the photosynthetic machinery is a complex process involving hundreds of genes. The structural genes that code for the Photosystems (PSI and PSII), the cytochrome *b₆f* and the ATP synthase, reside either in the chloroplast genome or in the nuclear genome, whereas the regulatory genes and the genes involved in the assembly of subunits and cofactors are all nuclear (Figure 8). The latter two categories are the subject of intense research as they are key factors in chloroplast biotechnology and the understanding of endosymbiosis. The host laboratory was involved in the identification of a number of these factors, either for the stabilization of chloroplast messengers (M factors) or in their translation (T factors), or in the transformation of apo-proteins into holo-proteins via the binding of co-factors (C factors). The recent publication of the nuclear genome of *Chlamydomonas reinhardtii* opens a new era of genomic research in this species [32].

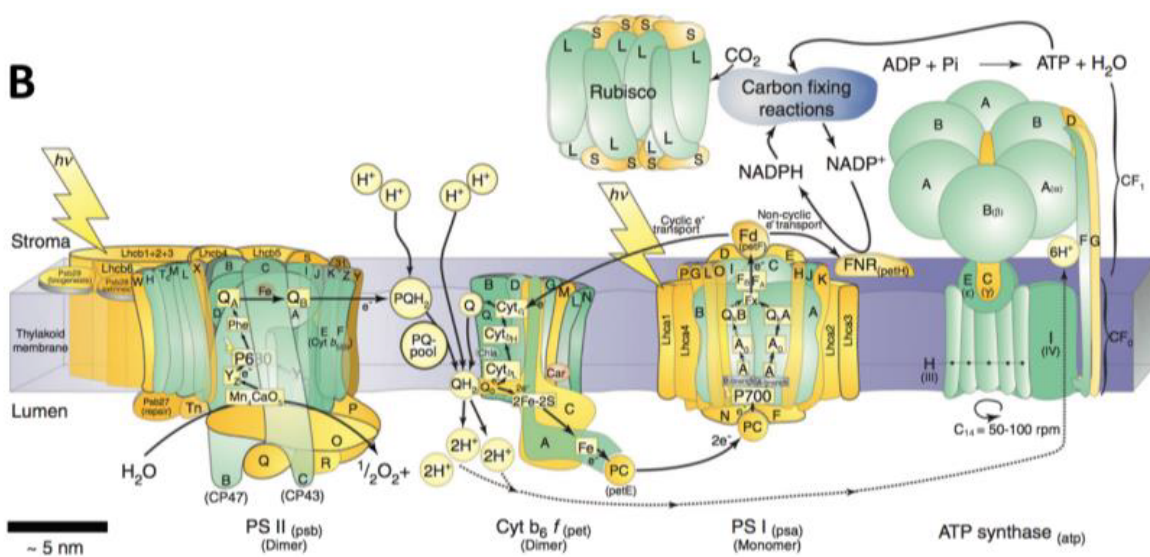

Figure 8. Schematic description of the photosynthetic machinery of the chloroplast in the stroma and thylakoids of Viridiplantae. Arrows show flows of electrons and protons within the system. Yellow subunits are nuclear encoded and green subunits are chloroplast encoded [33].

My project was to develop a medium-flow functional genomics technique targeting these biogenesis factors. Mutants were generated and complemented with an ordered cosmid library composed of 9306 cosmids (99 plates) each containing a genomic insert of about 30 Kb (279 Mb). For an estimated genome at 120 Mb, any element of the *Chlamydomonas* genome thus has a 95% probability to be in this library. The mutants were transformed with a DNA pool (containing 96 cosmids), prepared from a 96-well plaque of the library. To increase the flow rate, four mutants were mixed before transformation. Transformants were selected on their ability to grow phototrophically. When a pool is complemented (presence of phototrophic transformants), the complemented mutant is identified, and then the "minipools" of the plaque are amplified, allowing complementation (one pool for each row and each column). The intersecting well of the complementing minipools contains the cosmid that carries the gene of interest [34] (figure 10).

The recipient strain was first selected according to several criteria: high efficiency of transformation by electroporation (strain without walls, carrying the *cw15* mutation), active photosynthesis, robust growth and swimming, high ability to cross for genetic analysis. It carries an internal control of transformation the *arg7* mutation that is easy to complement, in a prototrophy gene for arginine synthesis.

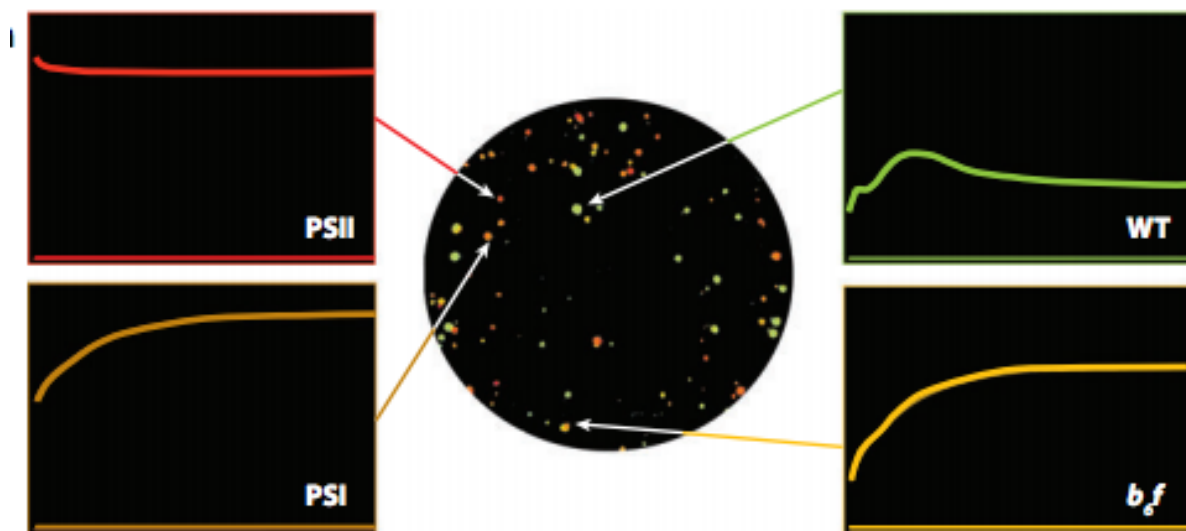

Figure 9. Sorting ac- mutants by their fluorescence phenotype.

The mutant library was generated by the insertion of the resistance genes *ble* (resistance of the antibiotic zeocin) and *aphVIII* (resistance of the antibiotic paromomycin) digested as

« cassettes ». The resistance cassettes were introduced by transformation. The transformants were then screened for a non-photosynthetic phenotype (*ac*, requiring acetate) by replication on a minimal medium without acetate as a carbon source. This technique makes it possible to identify *ac* mutants (between 0.2 and 1.2% of the transformants tested). When I added an enrichment step, using a strong light incubation with metronidazole to create toxic radicals in cells carrying an active electron transport chain, I increased the frequency of *ac* mutants to 14%. Within this project, 34 stable mutants were isolated and stored for future use. To sort them according to the nature of their photosynthetic deficiency, I analyzed the fluorescence induction curves of cells adapted to the dark by a home made chlorophyll fluorescence imaging camera. With this tool, photosystem I (PSI), photosystem II (PSII), cytochrome *b₆f* or mutants with a wild-type induction (WT) curve, such as ATP synthase mutants or those of the Calvin cycle can be differentiated (Figure 8). This initial characterization was refined either by absorption spectroscopy or by western blotting with antibodies against the various photosynthetic complexes (Figure 9). In parallel, complementation with a bank of cosmids was undertaken and crosses were performed to verify that the phenotype was due to a single mutation. The medium-flow complementation technique that I developed was proposed to identify new photosynthesis genes. It was the subject of an oral presentation and a communication in the Proceedings of the International Congress of Photosynthesis, at Hyeres in 2007 [35].

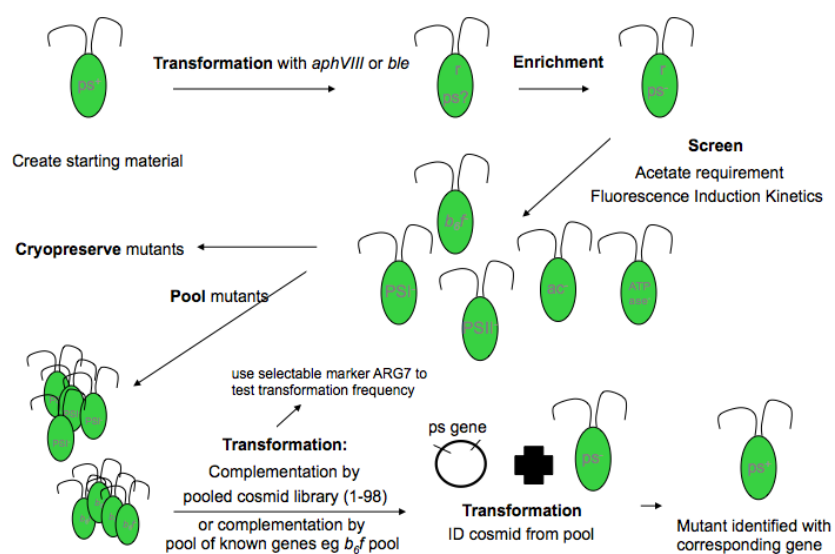

Figure 10. Schematic representation of a medium-flow functional genomics technique to isolate biogenesis factors of the photosynthetic complexes.

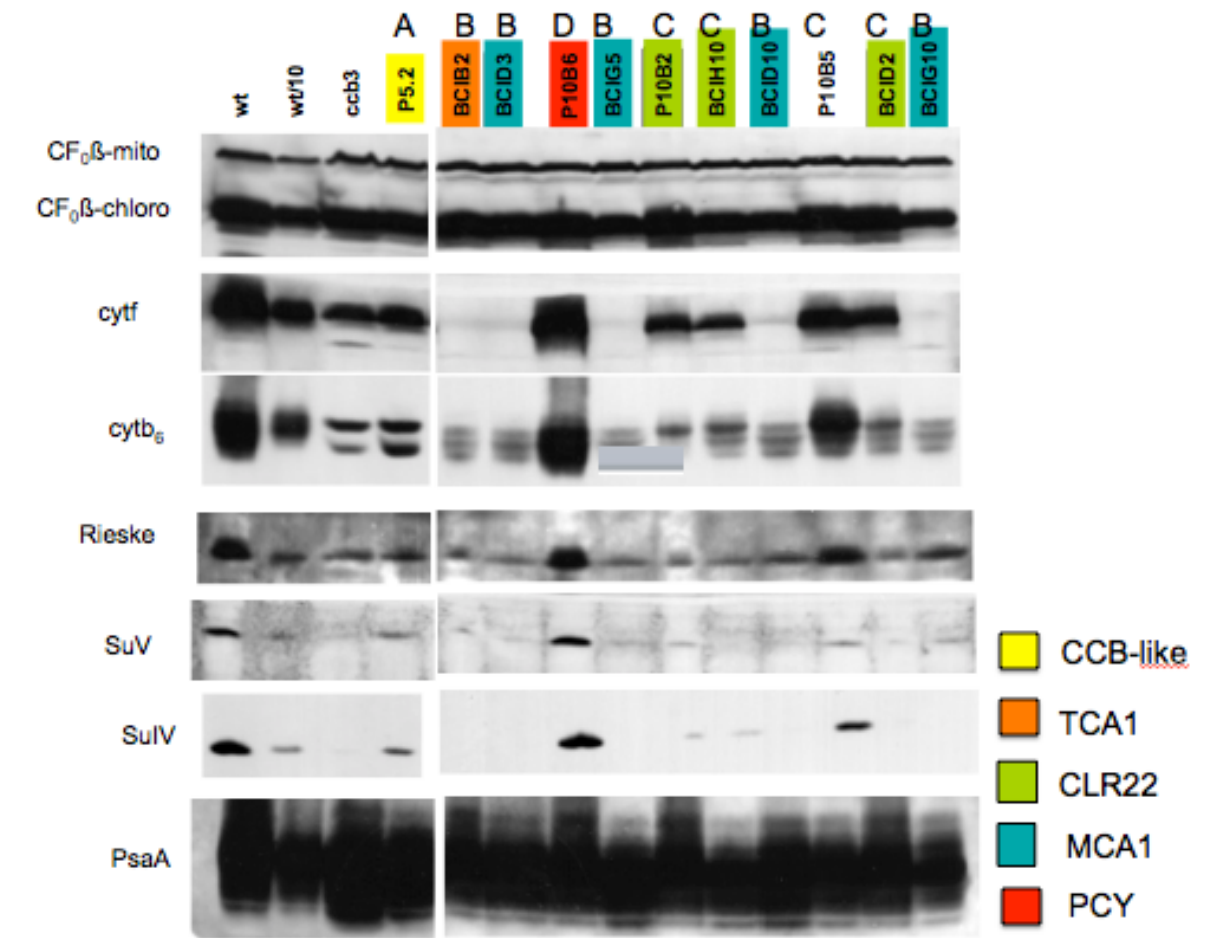

Figure 11. Sorting cytochrome *b₆f* mutants by their protein accumulation of subunit proteins belonging to the complex.

As our laboratory has a particular interest in cytochrome *b₆f* mutants, I first performed complementation trials with a collection of 13 previously known genes involved in the biogenesis of the complex. By Western blot, I differentiated four categories of cytochrome *b₆f* mutants lettered A-D in figure 11: one mutant was of the "ccb" type [36] having a particular signature for the blotted cytochrome *b₆*, but it is not complemented by any of the CCB genes currently known. Dr Kuras went on with this project and identified the gene mutated as a 12kDa protein with chloroplast targeting motif and unknown functional domains, this mutant was named *ccb5*. Five mutants lacked cytochrome *f*, three of which have the corresponding transcript, *petA*, in undetectable amounts that I could not complement by *MCA1*, the only known gene regulating the accumulation of this mRNA. Of the two with a normal *petA* messenger RNA, one is complemented by *TCA1*, a factor T already characterized in our laboratory [37]. Later on, Dr Choquet took the three mutants

that I could not complement with *MCA1* and sequenced *MCA1* in these mutants and found them all deleted or mutated for the *MCA* gene: strong support that this is probably the only M-factor for *petA*. Two mutants were deficient in plastocyanin (PCY), a soluble transporter downstream of *cyt b₆f* (PCY complementation, western blotting and spectroscopic analysis).

In addition, four mutants had a new signature for cytochrome *b₆*. One of the new mutants could be complemented by a single cosmid from the bank containing a gene coding for an Octa tetra penta peptide repeat (OPR) protein, annotated as CLR22 one of 120 OPR proteins predicted in the *Chlamydomonas* genome. OPR proteins are known to bind chloroplast RNA and there were already multiple examples in the literature when I began this work. Because the RNA stability targets for the major subunits of the *b₆f* complex were already known, I started by performing Northern hybridisation analysis on the smaller subunits, *PetG*, *PetL* and *PetF* to observe if their stability was affected by the absence of CLR22. Indeed, *PetG* was not accumulated either in polycistronic or monocistronic form in the *clr22* mutant. The mutant was promptly renamed Maturation/stabilization of C* subunit G, *mcg1*, according to the known nomenclature (* stands for the C complex of photosynthesis, cytochrome *b₆f*). The full analysis of this mutant and also another mutant isolated from the screen, this time affecting PSII accumulation and fully characterised in the lab of Joerg Nickelsen, named *mbi1*, were reported in an article published in 2015, entitled : *Two Chlamydomonas OPR proteins stabilize chloroplast mRNAs encoding small subunits of photosystem II and cytochrome b₆f* [38]

Three WT fluorescence mutants and one ATPase mutant were transformed with the whole cosmid library. The latter could not be complemented, and it seems that this is a still unexplained general characteristic of ATPase mutants. This mutant is particularly interesting, since it lacks the ϵ -CF1 subunit, encoded by the chloroplast genome. Since the biogenesis of ATPase is a major topic in the laboratory, the lab tried to identify by other techniques the mutated gene, presumably a nuclear factor regulating the expression of the ϵ subunit. The two complemented mutants having WT fluorescence kinetics were the subject of all further characterization during my time on this project.

The mutants were named *wildtype chlorophyll fluorescence*, *wcf2* and *wcf3*, because they exhibit normal fluorescence and starch production, accumulate all proteins of the electron transfer chain normally but they are photosensitive: after exposure to strong light for 24 h, they exhibit photoinhibition of PSII and partial loss of PSI. They show a reduction in oxygen production, compatible with a defect in the "dark" phases of photosynthesis. By immunoblotting, we observed a near-complete loss of Rubisco for *wcf2* and a complete loss for *wcf3*, the enzyme responsible for CO₂ fixation. The gene that complemented both these mutants was identified and the corresponding cDNA was cloned. It encodes a protein with pentatricopeptide repeat (PPR) motifs. While it is an immense family of proteins in higher plants (about 400), there are only a dozen PPR genes in *Chlamydomonas*. In general, PPRs addressed to organelles, chloroplast or mitochondria, contribute to the regulation of mRNA stability or maturation [39]. We therefore examined the level of accumulation of the mRNA of the chloroplast gene *rbcL*, encoding the large subunit of Rubisco. This mRNA is undetectable in mutants, confirming that the gene participates in its production or stabilization. It was therefore named *MRL1*, according to the current nomenclature (for Maturation / stabilization of *RbcL*) (figure 12). I carried out transformations with constructs comprising various parts of the *rbcL* gene (5' or 3' untranslated regions) combined with reporter genes, so as to identify the part of the mRNA that interacts with MRL1 and identified the interaction site as the 5'UTR of the *rbcL* mRNA. Using 5'RACE I verified the true start site of transcription of the *rbcL* gene. A complete characterisation of the MRL1 gene and protein was carried out over the course of the project, including Size Exclusion Chromatography and in depth complementation assays. I also created a true $\Delta rbcL$ mutant at this time, with the coding region from 5'UTR until 3'UTR replaced by a spectinomycin cassette. This mutant would be a valuable part of my collection at a later date (see Section 6).

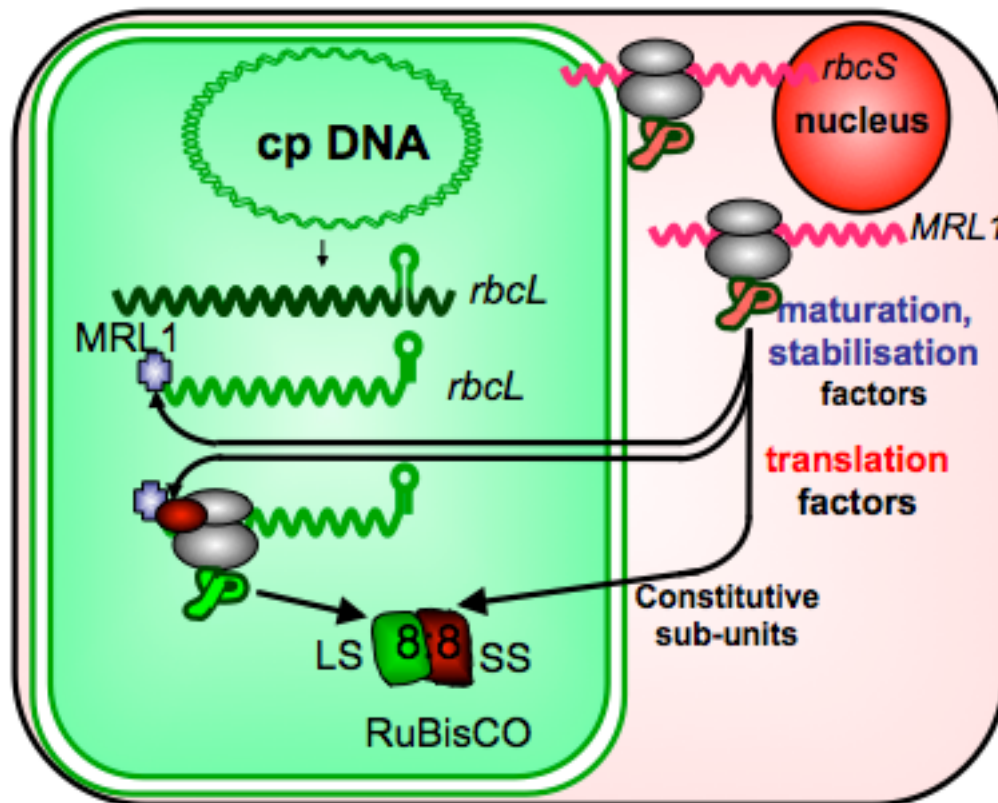

Figure 12. The role of MRL1 in stabilising and enhancing translation of the mRNA for the large subunit of Rubisco in *Chlamydomonas* and *Arabidopsis*.

One of the rare and interesting things about this protein was that it was conserved throughout the green lineage. This was unusual because we presume nuclear factors are a species specific set up of interactors without orthologues due to the random nature of 5' and 3' UTRs in chloroplast genes, that evolve and mutate at the nucleotide level without any selective pressure towards conservation. In collaboration with Katia Wostrikoff and David Stern of Cornell University we analysed the homologous *mrl1* mutant in *Arabidopsis* and found that there are two *rbcL* mRNA transcripts in *Arabidopsis* and MRL1 stabilises a longer primary transcript that is not essential for the accumulation of *RbcL* protein, with plants accumulating around 75% RuBisCO as in the WT. Interestingly it did have an effect on polysome accumulation showing it's presence increases total levels of translation of the *rbcL* transcript, represented by heavier ribosomal fractions carrying *rbcL* in the WT. The AtMRL1 protein appeared to be specific to *rbcL* stability from exhaustive northern blots of other chloroplast mRNAs that showed no differences in accumulation in the *Atmrl1* mutant. This work was published in 2010 in *The Plant Cell* [40].

The last mutant to be characterised from this collection was a mutant lacking PSI that we sent to the laboratory of Michel Goldschmidt-Clermont, at the University of Geneva, due to his abiding interest in PSI biogenesis. He and his team went on to perform the full characterisation of this mutant showing that it was a HAT (half a TPR protein) type maturation factor for *PsaC*. They called it MAC1. They used changes in iron availability, a condition known to effect PSI accumulation due to this complex's high Fe requirements, to show that MAC1 accumulation also responded strongly to Fe limitation showing the same reduction in accumulation as *PsaC* mRNA and protein, implying a type of top down control from this nuclear regulator. They could also show a causal relationship between phosphorylation of MAC1 and its degradation rate in these conditions, thus the first time a nuclear regulator was shown to have post-translational modification linked to its activity. This work was also published in *The Plant Cell* [41].

Project Conclusions and Perspectives.

What I learnt during this 3 year period was critical for my future research projects. I learnt how to generate large scale mutant libraries in a unicellular photosynthetic model species. I learnt biochemical techniques and techniques to analyse photosynthetic electron fluxes and I used these to sort and refine the characterisation of a library. I learnt how to use selection techniques for complementation in microalga. I learnt the notions of the biogenesis of multi-subunit complexes and I discovered a new conserved factor and insisted on characterising it despite pressure from the laboratory to work on the cytochrome *b₆f* complex, thus I developed my own ambitions over this period and reinforced my scientific confidence. I began conceiving questions that I thought were important and interesting and pursuing them on my own time. The atmosphere of the laboratory has a lot to do with my progress as a scientist over this period. The laboratory had 12 researchers and very little technical staff, which meant that all of the researchers were still in the lab and performing experiments, which also made these people accessible for scientific conversations and discussions at any moment. The head of the lab, Francis-Andre Wollman strongly encouraged discussion and « thinking » in his laboratory, i.e. « why are you doing this experiment », « what does that result mean? », « How we can we take this question further, what experiment shall we do next ? ». I became self reliant and critical of my own experiments during this period. Finally, the laboratory at the time was a half-half mix of molecular biologists/geneticists and

biophysicists, which made the depth of conversation very interesting and complete. As a member of this lab for 6 years my overall impression now is that it felt like we were missing no specialist at hand's reach to answer any question about photosynthesis.

The code for the PPR – RNA interactions although complex is now more or less cracked with continued work going on to understand the nuances of the mechanism [42]. PPR tracts bind RNA by one coiled repeat binding to one nucleotide, however while artificial PPR proteins have been designed for the recognition of new targets, the model does not yet fully explain the binding recognition of native targets [43]. Biogenesis and their related nuclear factors will be important targets for understanding the complex traits of photosynthetic improvement in the field. The PPR protein *Yellow Seedling 1 (YS1)* was recently identified in an *Arabidopsis* QTL screen for photosynthetic traits contributing positively to acclimation processes. YS1 works via upregulation of the transcription of chloroplast genes via RPO and indirectly via changes to chlorophyll antenna protein accumulation [44]. My understanding of these processes is an asset for future projects in which we would like to understand the determinants of photosynthetic productivity (further discussed in Section 6).

5. The alternative electron transfer pathways in photosynthesis, functional conservation in the GreenCut and their intersection with metabolism: my partnership with Jean Alric from 2010 – now.

At the end of this work a whole new vista opened for me. My funding from the ANR had come to an end and I had a new supervisor, Jean Alric, who had won funding from the Fondation Pierre-Gilles de Gennes pour la Recherche to study *in vivo* photosynthetic fluxes. We undertook the development of a new imaging camera and I used this tool for the study of alternative electron transfer pathways including a new screen for a mutant library. For the new mutant library we were funded by the ANR Algomics project. This project was aimed at identifying new molecular targets involved in alternative electron transfer pathways. We also began to visit Arthur Grossman at the Carnegie Institute of Science at Stanford Ca., to work with him on his GreenCut project.

I began to be interested in the study of the electron transfer pathways themselves rather than the biogenesis of the photosynthetic complexes. In my interactions with the biophysicists in the laboratory, I began to understand and see the power in certain techniques such as chlorophyll fluorescence, the Clark electrode for measuring the evolution and uptake of oxygen, and other spectroscopic techniques that had been conceived in this lab, using particular wavelengths for excitation and others for detection along the electron transfer path of photosynthesis to measure defects and points of control in the photosynthetic chain. I was involved at this time in the preparation of a manuscript about a new chlorophyll fluorescence imaging camera that had been conceived by Daniel Beal, Guillaume Vandystadt and Jean Alric and I could see the interest that it had for me for future mutant libraries [45].

While the biogenesis of the photosynthetic complexes is still full of unknowns, the major subunits of the photosynthetic complexes that carry out linear electron flow and the enzymes of the Calvin Cycle that fix CO₂ have been known for a few decades. With the increasing knowledge that I had about photosynthesis and the influence of Jean Alric, I

learnt that the regulation of photosynthesis had been studied physiologically for many years but had very few known molecular players. These regulatory pathways are named alternative electron transfer pathways because they divert electrons towards an alternative ultimate acceptor other than CO₂ fixation, protecting the cell against redox and light damage that leads to generation of reactive oxygen species without contributing to growth (biomass). These include the cyclic electron flows, chlororespiration, the malate valve, triose-P translocation, Mehler and non-Mehler oxygen photoreduction and non-photochemical quenching pathways that relieve excess light at the level of PSII, that include: state transitions (qT), excitation quenching (qE) and photoinhibition (qi).

It was at this time that I began using the tool of chlorophyll fluorescence in conjunction with molecular techniques to look further at the « wt » chlorophyll fluorescence kinetics observed in the RuBisCO mutant. I started by asking the question « Where do the electrons go in the absence of RuBisCO ? » and I am still asking this question today. As a first step to answer this question, I revisited the nuclear factor, Maturation/stability of *RbcL* (*MRL1*), to complement *mrl1* mutants by random transformation of the nuclear genome with the *MRL1* cDNA and achieved different levels of *rbcL* transcript accumulation. Here, I could correlate the levels of *rbcL* transcript with levels of RuBisCO Large Subunit (LSU) accumulation showing that complemented strains accumulating as little as 15% RuBisCO protein can grow phototrophically while RuBisCO in this range is limiting for phototrophic growth. We also observed that photosynthetic activity, here measured by the quantum yield of PSII, appears to be a determinant for phototrophic growth (figure 13). In some strains that accumulate less RuBisCO, a strong production of reactive oxygen species could be detected. I hypothesised that in the absence of RuBisCO, oxygen could act as the PSI terminal electron acceptor. These results showed that random transformation of *MRL1* into *mrl1* mutants can change RuBisCO accumulation allowing a range of phototrophic growth phenotypes. Furthermore, this technique allowed for the isolation of strains with low RuBisCO, within the range of acceptable photosynthetic growth and reasonably low ROS production. I concluded that *RuBisCO* mutants are potential tools for applications to divert electrons away from photosynthetic carbon metabolism and towards alternative pathways. This work, performed alone with technical advice from Jean Alric was my first sole author manuscript [46].

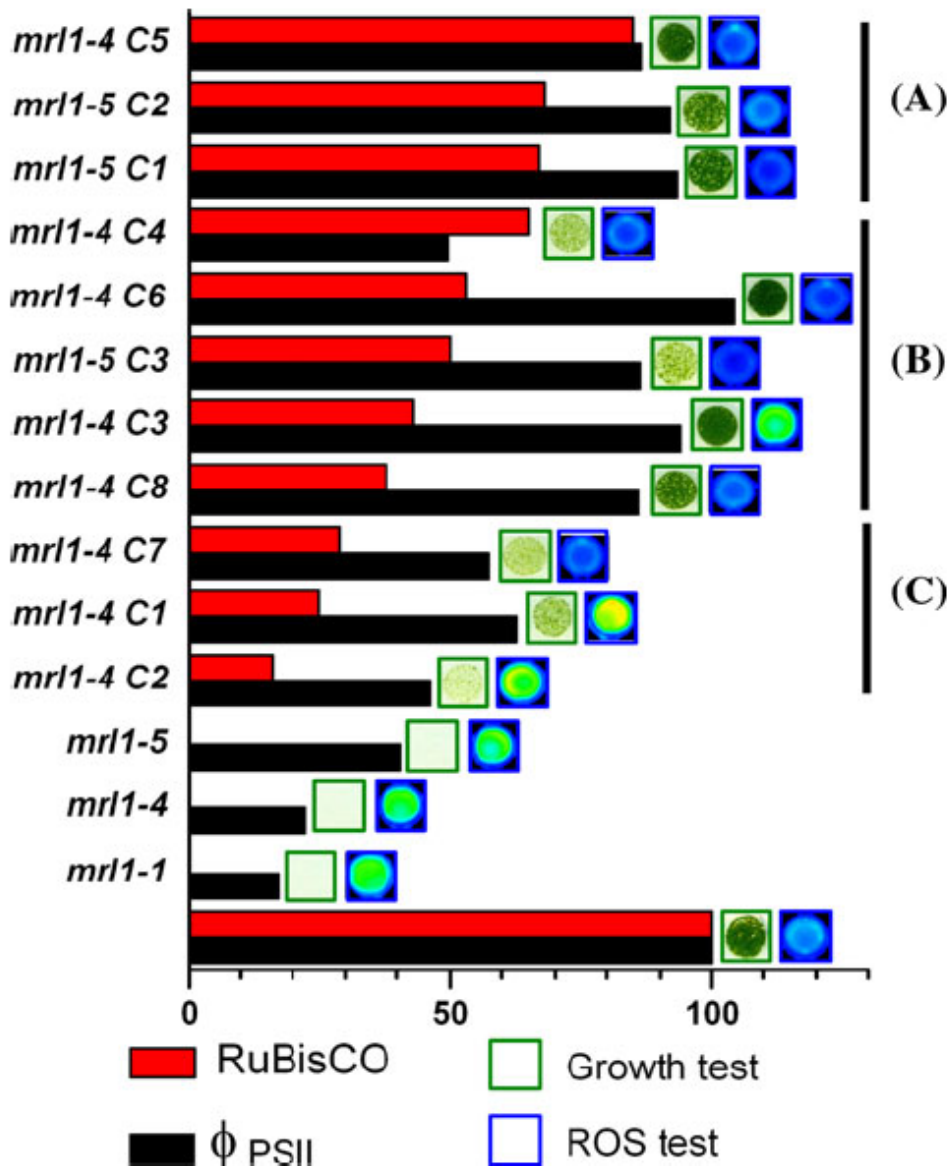

Figure 13. Different levels of LSU accumulation and Φ PSII in complemented *mrl1-4* and *mrl1-5* C strains determine phototrophic growth. LSU accumulation (red bars) and Φ PSII (black bars) are presented as a percentage of wild type levels and the histogram is presented from top to bottom as those accumulating highest LSU (A group), those accumulating intermediate levels of LSU (B group) and those accumulating lowest LSU (C group). Three *mrl1* alleles and the wild type are also shown. The Φ PSII was taken from cells grown on solid TAP media at low light for 1 week and the growth images (green squares) displayed come from the same cells grown on minimal medium at $150 \mu\text{mol photons m}^{-2} \text{s}^{-1}$ for 1 week. ROS production (blue squares) is also shown as an image of the signal generated after 1 h of exposure to very high light.

This work was performed at the same time as a new mutant library was being created to screen for alternative electron transfer pathways. A PhD student, Laura Houille-Vernes joined the group and was placed under my supervision. We created an insertional mutant library of 120000 mutants in the new genetic wild type background, JEX4, this time a cell-walled but high transformation strain with good crossing and normal photosynthetic

phenotype. Richard Kuras developed a protocol to transform cell-walled strains and we took advantage of this because *cw* strains are difficult to work with in other applications. Instead of screening for *ac-*, i.e. non-phototrophic mutants, we used the new imaging system and screened directly on unusual chl fl kinetics in the search for alternative pathways to linear electron flow. Eighty mutants were isolated, 40 had reproducible fluorescence kinetics, and 8 of these were *ac+*. Two of these mutants shared similar chlorophyll fluorescence kinetics, these mutants had a reduced plastoquinone (PQ) pool in the dark witnessed by an elevated dark fluorescence (F_0) and a reduced PSII antenna size (signifying « State 2 » that is, majority of PSII antennae are attached to PSI). In the light, the PSII antenna size increased and reattached to PSII (PQ pool oxidised). After the light period a return to the dark witnessed a peak of high chlorophyll fluorescence suggesting that PQ pool was reduced again (Figure 14A).

Over the next year, Laura, Jean and I completed the characterisation of these mutants that we identified as having an insertion in a gene orthologous to the plastid terminal oxidase of plants. This gene was annotated in the *Chlamydomonas* genome as *PTOX2* (*PTOX1* had higher sequence homology to the plant *PTOX* known as *IMMUTANS*) and both mutants *ptox2* knock outs (figure 14B and C). We were able to show that PTOX2 was the major oxidase involved in chlororespiration, the light-independent electron transport pathway in chloroplasts, involving plastoquinones as electron carriers in the oxygen-mediated oxidation of NADPH. From the literature we the rate of catalysis by PTOX was expected to be so slow that we had to devise a tool to measure its *in vivo* activity because it would be outcompleted by linear electron in the presence of PSII in the light. Thus, we used a *cyt b₆f* mutant and created a double *ptox2 cyt b₆f* mutant and compared the oxidation rates of the PQ pool in the light. We could show that PTOX2 had a rate of $5 \text{ e}^- \text{ s}^{-1}$. PTOX1 was still accumulated in the *ptox2* mutant (figure 14D) and its activity could be calculated as around 1/10 of that of PTOX2, deduced from the residual PQ oxidase activity in the double *ptox2 cyt b₆f* mutant in the presence and absence of the inhibitor, propyl gallate. This work was published in PNAS in 2011 and was my first last author publication [47].

An offshoot of this project was the observation that the double mutant *ptox2 cyt b₆f* was more light sensitive than the single *cyt b₆f* mutant (Figure 14E). This mutant is precious

because it allows us study what happens in the cells of *Chlamydomonas* when the PQ pool is very reduced (>99%) because the two major enzymes that can oxidise PQ are missing. When this mutant was grown in the dark and then exposed to light above $20 \mu\text{mol s}^{-1} \text{m}^{-2}$ it became brown. We were able to identify the brown substance as protoporphyrin IX, an intermediate in heme and chlorophyll biosynthesis. When we inhibited electron flow from PSII using DCMU we were able to suppress this phenotype, suggesting that there was a link between the state of reduction of the PQ pool and the synthesis of protoporphyrin IX. This project is still on going and continues with collaboration from Michel Havaux and Brigitte Ksas from our institute as well Pawel Bzrezowski and Bernard Grimm of Humboldt University Berlin.

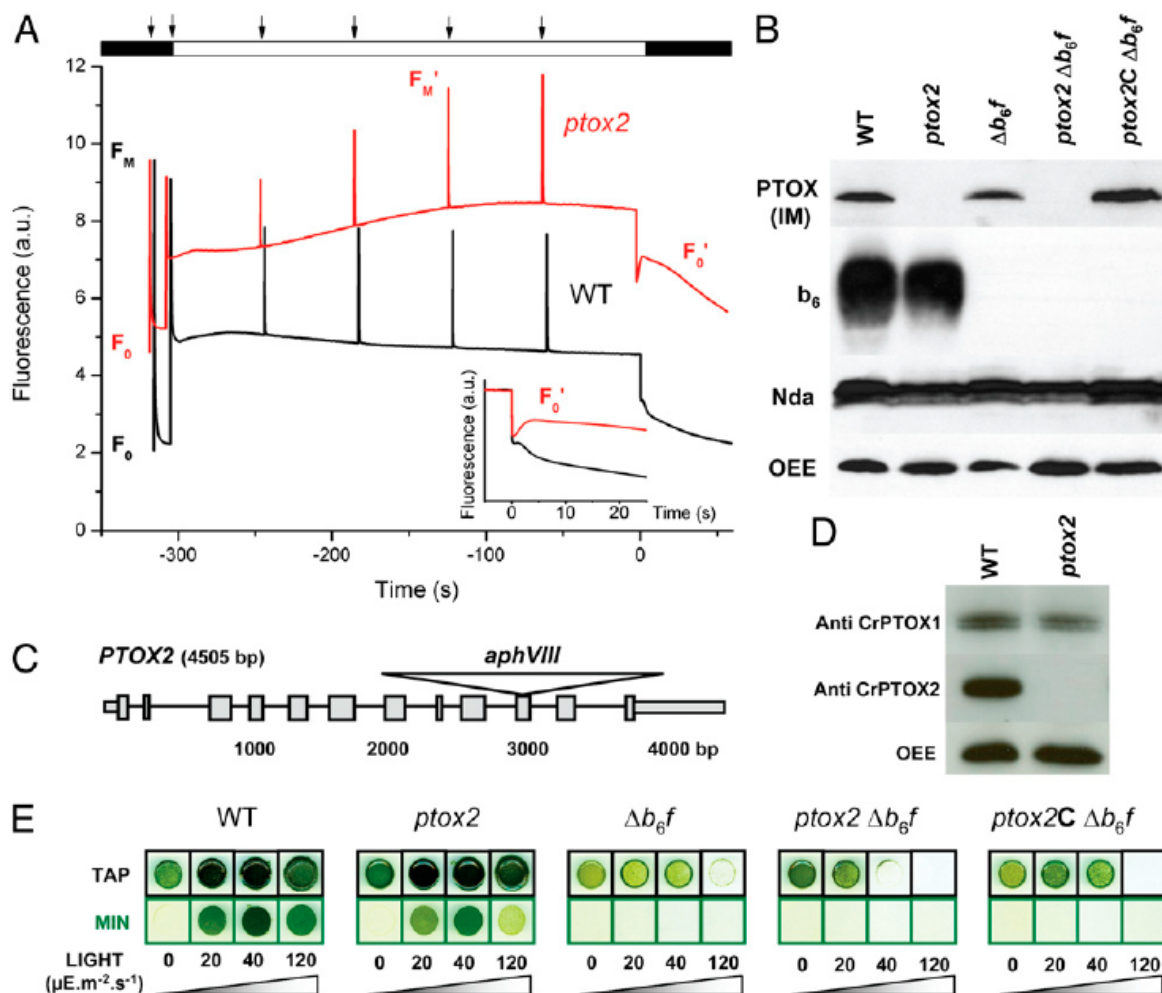

Figure 14. Screening of insertion mutants and characterization of *ptox2*. (A) Fluorescence kinetics of *ptox2* versus WT. The fluorescence rise observed after the period of illumination is indicative of a dark reduction of the PQ pool more pronounced in *ptox2* than in the WT (Inset). (B) Western blot showing WT, *ptox2*, Δb_6f , *ptox2 \Delta b_6f*, and *ptox2C \Delta b_6f* (the complemented double mutant) total cell proteins, reacted with antibodies: Arabidopsis (IM) anti-PTOX, cytochrome b_6 , and NDA2, and oxygen evolving complex (OEE) from PSII was used

as a loading control (for other controls of PSII content in *ptox2*, see Fig. S2). (C) Scheme of *aphVIII* insertion in *PTOX2*. (D) Western blot with thylakoid extracts from WT and *ptox2* reacted against CrPTOX1 and CrPTOX2 purified antibodies. (E) Double mutants are more light-sensitive than single mutants.

I was very lucky during this period to have had the chance to meet Arthur Grossman, a professor with a long and illustrious career in studying microalgae, specifically *Chlamydomonas* photosynthesis and nutrient metabolism. He was able to fund a visit for Jean and I (and our baby Claire ☺) to his lab in the summer of 2009. He had just had a large NIH programme funded to explore the GreenCut, which was a way to use *Chlamydomonas* as a reference organism for identifying proteins and activities associated with the photosynthetic apparatus and the functioning of chloroplasts. This analysis had been published with the full genome sequence of *Chlamydomonas*, using the gene models, and gene models developed for the genomes of other organisms, and a phylogenomic, comparative analysis was performed to identify proteins encoded on the *Chlamydomonas* genome which were likely involved in chloroplast functions because they are found in photosynthetic organisms but not in animals (figure 14). This set of proteins was thus designated the GreenCut. The generation of a mutant bank in his lab was underway and we were involved in its characterisation, from 2009 until 2014, both in his lab in 2009 and during our return to his lab for a year in 2011 and ongoing during our return to France. This mutant library was the first to attempt a reverse genetics approach where a large library was generated (25000 insertional mutants) and then screened using primers specific to the GreenCut genes and to the cassette used for the mutagenesis [48]. Using this technique a number of valuable mutants were isolated and characterised and we were associated with an initial introduction to this project as a review paper [49]. We were, over this period, implicated in the molecular, biochemical and biophysical characterisation of several mutants : *cp1d38* [50] and *cp1d49* [51] in stability and accumulation of *cytb₆f* holocomplexes; *pgr5* [52] the functional orthologue of the cyclic electron flow mediator already characterised in *Arabidopsis* and *fdx5* [53], a dark functioning, chloroplast ferredoxin essential for donation of reducing equivalents for fatty acid desaturation contributing to the stability of thylakoid membranes. During the year of 2011 I helped supervise the thesis student, Tyler Wittkopp in his studies on *cp1d49*.

The beauty of the GreenCut work is the conservation of these proteins across

photosynthetic species and thus the conservation of the basis of the activity of these proteins. This concept had already formed a connecting line in my work as something I believe is primordial to the study of biology, some of the greatest gifts that molecular biology and the genomic era have given us is this proof of functionality throughout evolution. The GreenCut tool can be appreciated as an invaluable tool for us now to explore the most fundamental pathways in chloroplast biogenesis, regulation of photosynthesis and endosymbiosis and is the basis of my on going project on translational photosynthesis.

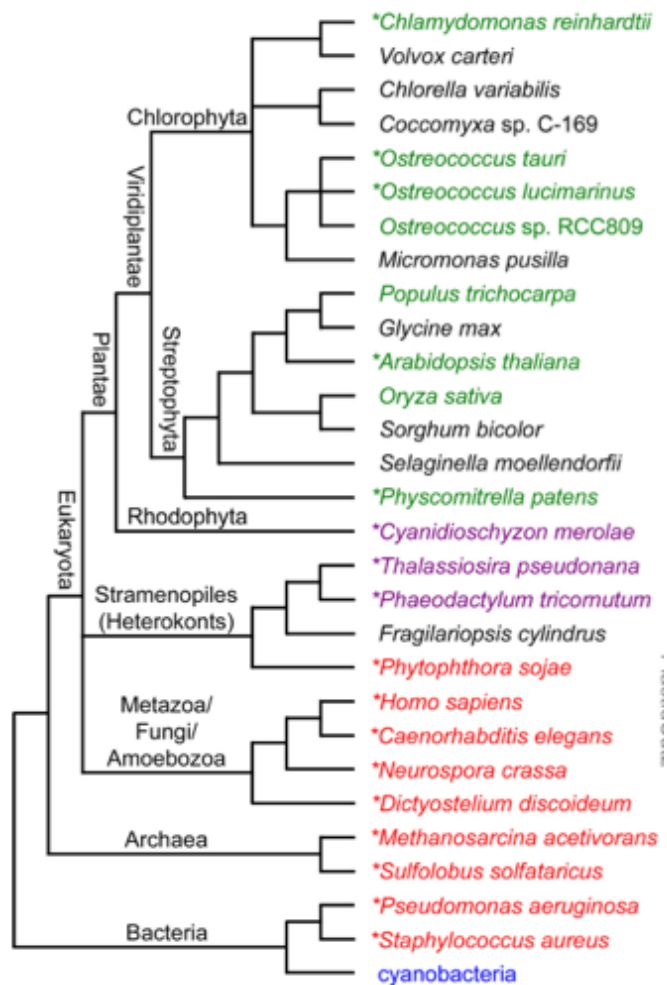

Figure 15. *Chlamydomonas reinhardtii* is haploid, and has a nuclear genome comprising 17 chromosomes with a total size of ~120 Mbp, with 14 400 coding genes. By comparing these genes against the genes of other sequenced species in green and red *Chlamydomonas* appeared to have a genetic makeup composed of both plant and animal genes. Genes that were present in the green lineage genomes and always absent in non-green lineage make up the green cut: 597 conserved proteins that may function in the chloroplast. Interestingly, more than half of these have of an unknown function, so as potential candidates for photosynthetic regulators they have enormous potential and because this analysis is conservation-based it's not only a tool for algae but for plants as well.

Part 6. Current and Future Projects and Perspectives

Translational photosynthesis towards algal and crop improvement

Questions :

How do we quantitatively measure a photosynthetic yield ? What is the most appropriate way to measure an « improvement » in photosynthesis ?

Since the early days of research in photosynthesis, the proper measurement of the quantum yield of photosynthesis (or its minimum quantum requirement, see below for a definition of these terms) has been a crucial step towards the understanding of the mechanisms of photosynthesis. The minimum quantum requirement for CO₂ fixation is the number of quanta (or photons) required for the fixation of a CO₂ molecule. It is determined by the structure and function of the photosynthetic chain and the Calvin cycle. It is in studying these questions that researchers discovered the presence of two different photosystems, and now we know the identity of regulatory functions / alternative pathways, we must go back to these basics to understand how to improve the energetics of the photosynthetic machinery.

A yield can be described simply as :

$$\text{Yield} = [\text{product}]/[\text{substrate}]$$

And is always < 1, with 1 being a complete conversion of substrate into product.

In photosynthesis we consider the photosynthetic yield as:

$$\text{Net \# CO}_2 \text{ fixed or O}_2 \text{ evolved} / \text{\# photons delivered to the sample (i.e. incident light)}$$

When we plot O₂ evolution against incident light what do we see? We see that [O₂] produced per unit time reaches a plateau when a certain quantity of photons is reached. After that saturation point, the photosynthetic yield reaches zero since additional light energy is not used for O₂ evolution but is dissipated as heat (figure 16). This graph shows us that photosynthetic yield is best at low light intensities (limiting light conditions) before photosynthesis is saturated, when O₂ evolution increases linearly with light intensity. We will

call this region $< I_k$.

Photosynthesis – Irradiance Curve

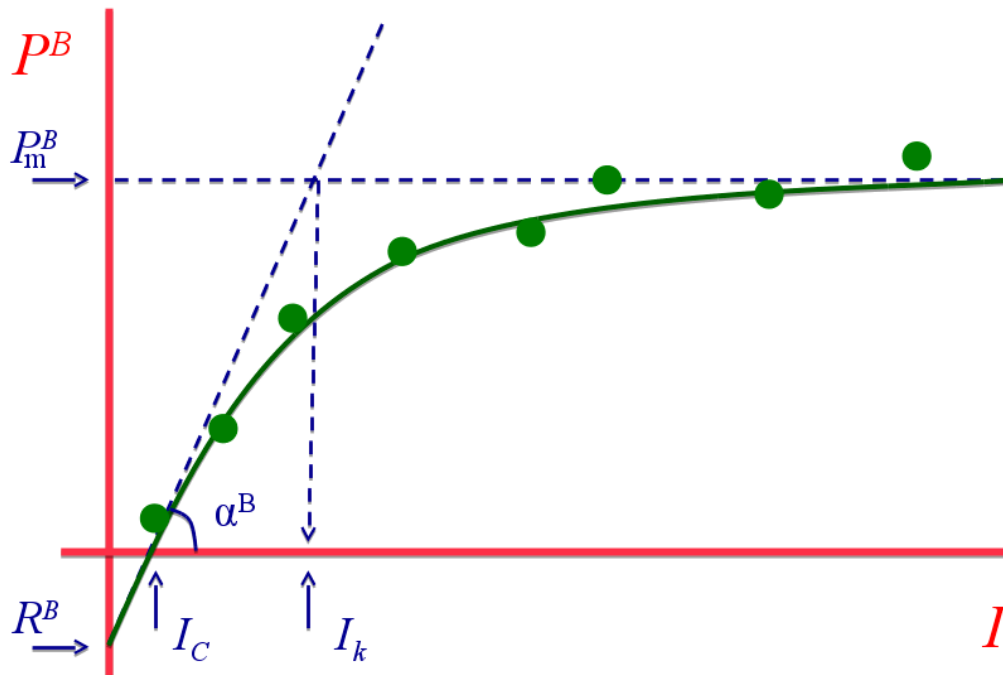

Figure 16. Schematic photosynthesis response to irradiance, gas exchange rate (O_2 evolution rate, or CO_2 assimilation rate) plotted against light irradiance. I_c light compensation point; limiting light $< I_k <$ saturating light; P_m^B , maximal rate of photosynthesis; R^B , respiration rate in the dark; α^B , maximum photosynthetic efficiency (figure designed by J. Alric).

This brings us to another more precise measurement of photosynthetic yield, that is the quantum yield of photosynthesis (α^B). We can do experiments to measure α^B in the $< I_k$ range. Around I_c , a break in the slope α is observed and referred to as the "Kok effect" [54]. If we neglect this and take into account O_2 or CO_2 as a real measure of photosynthesis but this time we do not divide by the number of photons *delivered* to the sample, but by the number of photons *absorbed* by the sample, we can estimate the quantum yield of photosynthesis.

Quantum yield of photosynthesis = # molecules CO_2 or O_2 / # absorbed photons

or

Minimum quantum requirement = 1/ Quantum yield

= # of photons for the fixation of 1 molecule of CO₂.

Unfortunately, the number of absorbed photons is difficult to measure experimentally, and can easily lead to some significant discrepancies between measurements.

Emerson's measurements of O₂ evolution show that to fix 1 molecule of CO₂ we require 9-11 photons, so if we take 9 (for example) :

Minimum quantum requirement = 9 absorbed photons / 1 CO₂

The inverse of this equation gives us the Quantum yield (1/9) = 0.08

The photosynthetic apparatus absorbs light at different wavelengths and its action spectrum (roughly resembling the absorption spectrum) is limited to wavelengths shorter than 700 nm. If we plot the quantum yield against the wavelength of the photons we find that the quantum yield stays approximately constant (as expected because the photochemical process does not depend on the energy of the photon, but on the number of quanta) but rapidly drops when the far red is approached. Although less photons are absorbed at 700 nm, explaining why the action spectrum of photosynthesis decreases in this spectral region, this is not why Quantum Yield drops in the far red. Quantum Yield (Q) is independent of the number of delivered photons since it is expressed per number of *absorbed* photons. The Q - red drop shows that more absorbed 700 nm quanta are required for O₂ evolution, revealing a singular friction of the photosynthetic apparatus.

This historical photosynthesis experiment remains the only proper way to measure the quantum yield of photosynthesis (figures 17 and 18). It showed that some pigments were not directly associated with O₂ evolution, and later on, with the discovery of the Emerson enhancement effect, that two different wavelengths, or light 1 and light 2 (corresponding to PSI and PSII) cooperate to evolve O₂ [55]. This was confirmed by the discovery of the antagonist effect of light 1 and light 2 on the steady state level of cyt f oxidation and definitively validated the Z-scheme of photosynthesis [56].

In more modern terms, pigments associated to PSI absorb far red light but PSII excitation is too low, thus many more photons are absorbed to fix 1 molecule of CO₂ and the quantum yield rapidly drops. Any imbalance between PSI and PSII excitation is therefore expected to decrease the photosynthetic quantum yield.

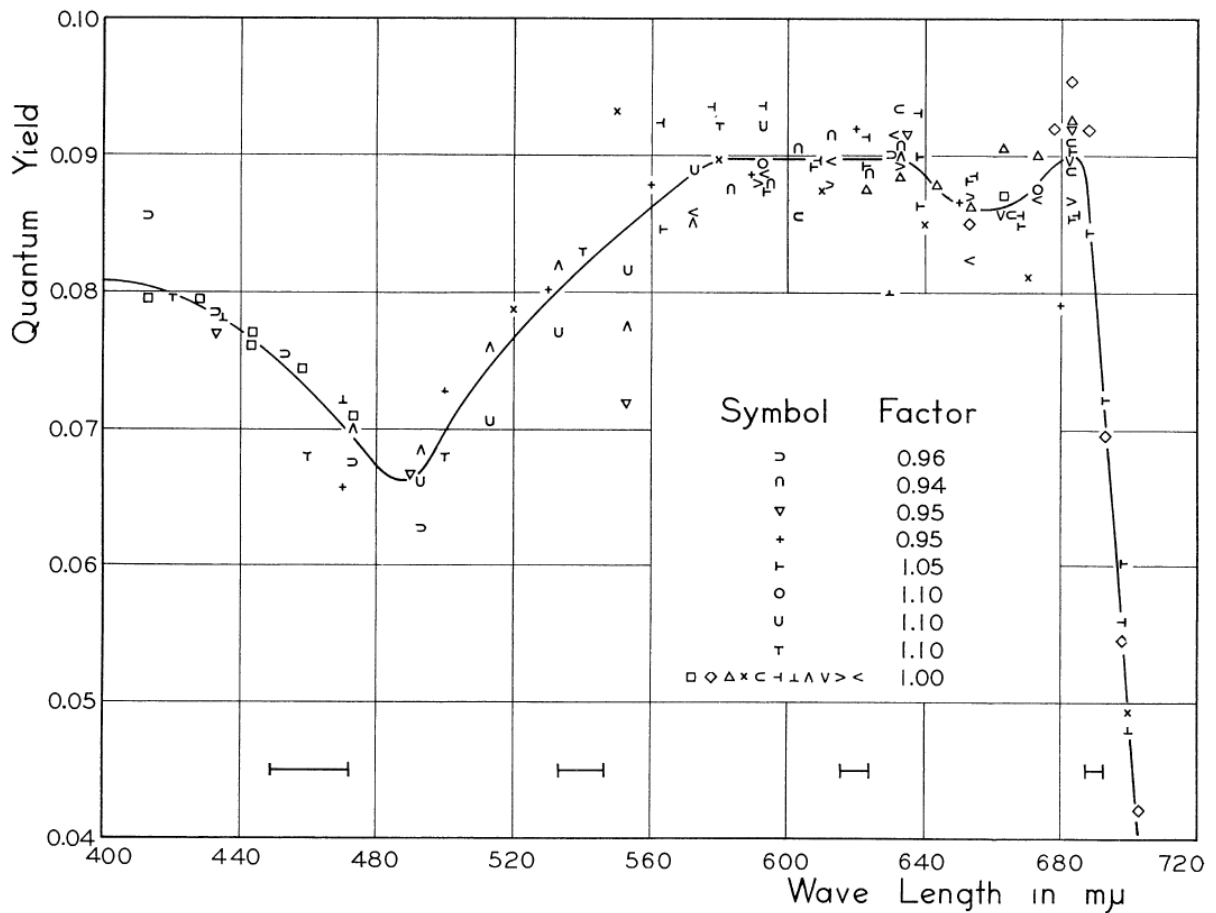

Figure 17. Reproduced from Emerson and Lewis, 1943 [57], the quantum yield of photosynthesis measured in the green algae *Chlorella pyrenoidosa* (now *vulgaris* or *sorokiniana*) plotted against the wavelength of excitation in nanometers (or millimicrometers, mμ). It shows a drop in the far-red region of the spectrum where the light is still significantly absorbed by PSI.

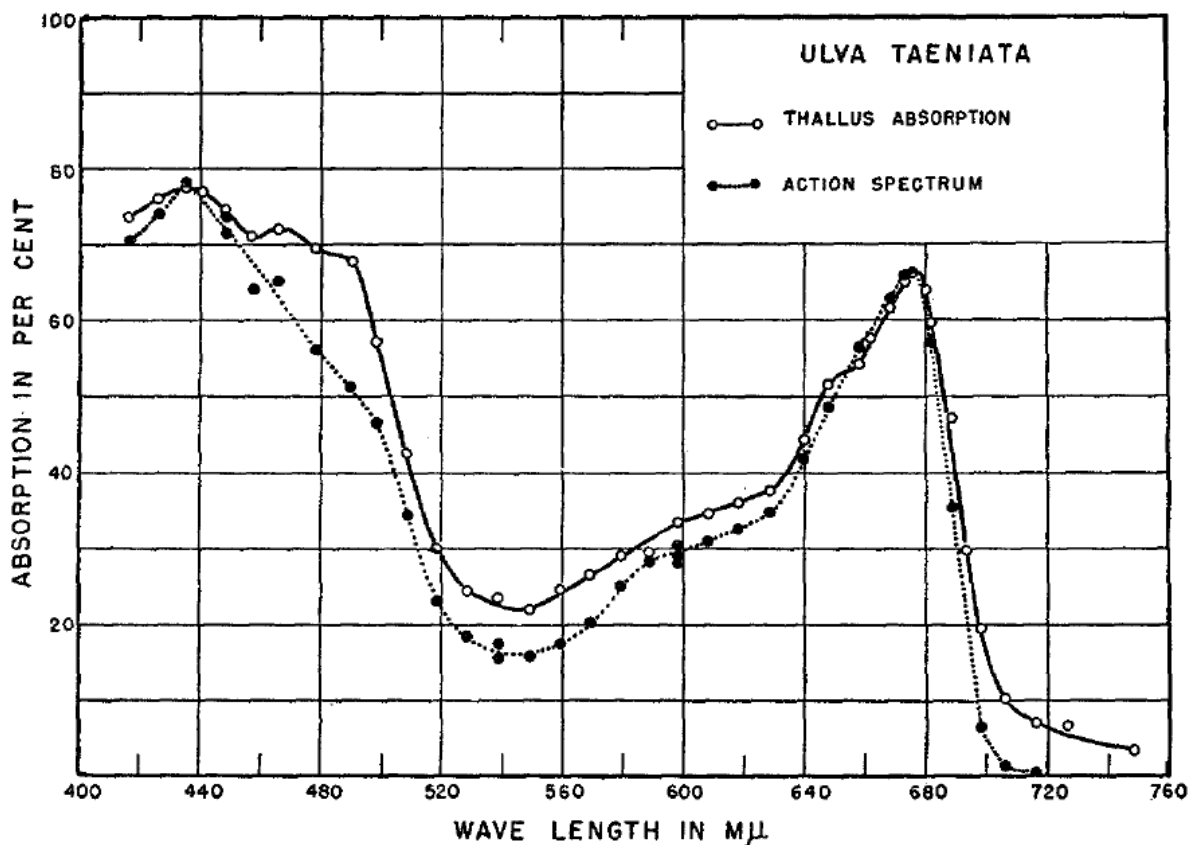

Figure 18. Reproduced from Haxo and Blinks, 1950 [58], comparison of the action spectrum of photosynthesis to the absorption spectrum of the photosynthetic thallus. It shows that some wavelengths are absorbed but do not contribute as much to the action spectrum. Some carotenoids (~480 nm) are not connected to the photosystems and PSI alone (> 700 nm) does not contribute to O₂ evolution.

Interestingly, these « classical studies of photosynthesis » also pointed to regulation processes like state transitions where light 1 and light 2 were shown to induce changes in photosystem antenna sizes [59]. Many years later, after state transition mutants were isolated, it was shown that state transitions optimize the quantum yield of photosynthesis. More generally we can address the question of the relation between regulatory processes and photosynthesis quantum yield. For example, any NPQ would decrease the PS quantum yield (NPQ mechanisms convert absorbed photons into heat, therefore contributing to a decrease in quantum yield). Any « valve » of the alternative electron transfer pathway would have the same effect. To my knowledge, there is no quantitative measurement on the quantum yield of photosynthesis for the mutants that are now available (PTOX, FLV, PGR5, PGRL1, NDA2, etc...). See figure 19 for a recent figure showing known electron transport “valves” [60].

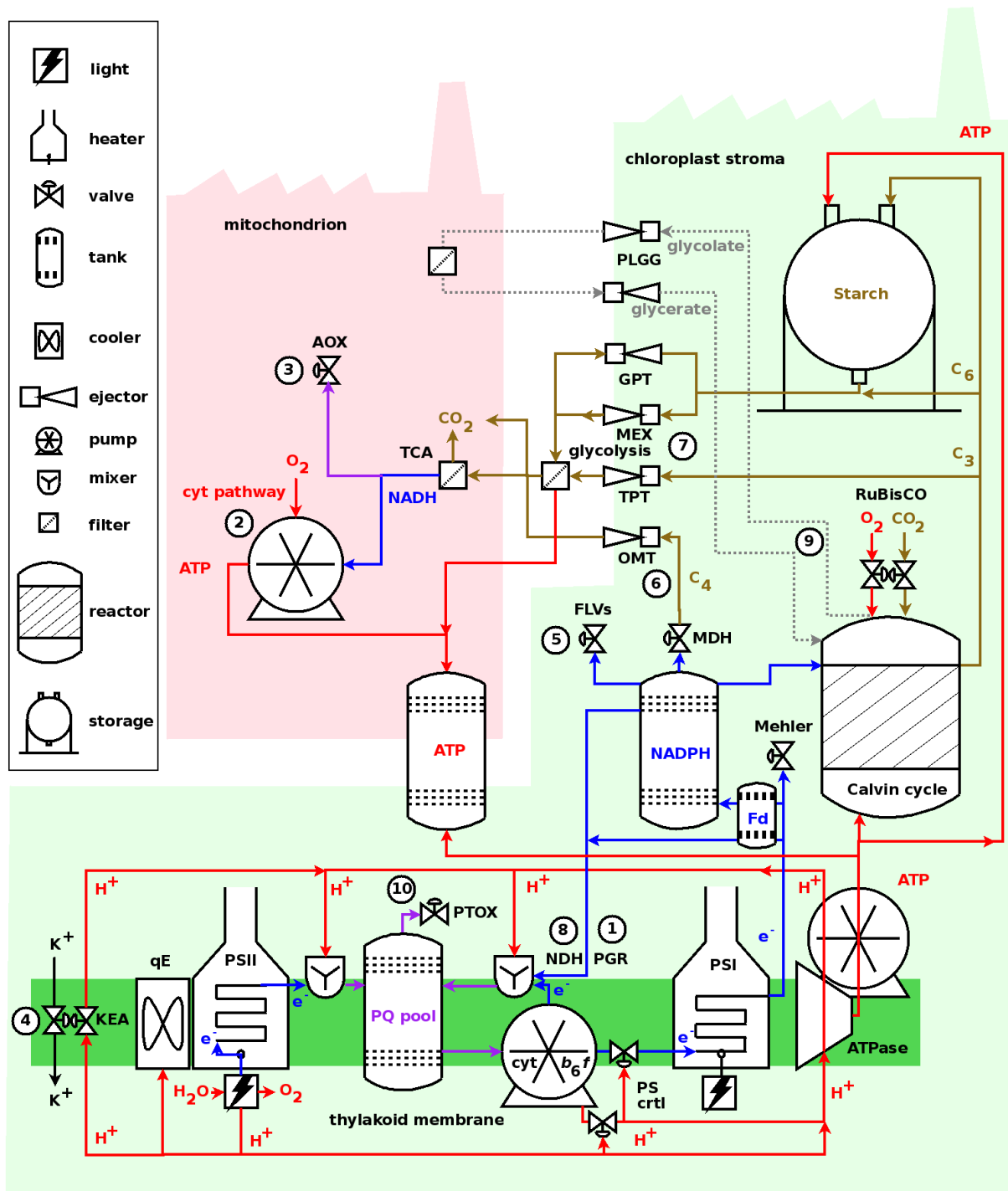

Figure 19. Process flow diagram of the biochemical reactions of photosynthetic eukaryotes. The simplified bioenergetics reactions of respiration are shown in the mitochondrion (pink shading) and the photosynthetic reactions along the thylakoid membrane (green strip) and chloroplast (green shading). Whereas the respiratory chain oxidizes NADH (blue) to make ATP (red, oxidative phosphorylation), the photosynthetic chain makes NADPH (blue) and ATP (red). These are used for CO₂ capture, synthesis of C₃ and C₆ metabolites and starch storage (brown). Metabolites are exchanged between various cellular compartments through specific shuttles (shown as "ejectors"). Alternative pathways are shown as "valves" (exhaust valves like PTOX, AOX, FLVs or Mehler or flow control valves like PS ctrl); "H⁺/e⁻ mixers" (PQ + 2H⁺ + 2e⁻ ⇌ PQH₂); or "coolers" as in dissipation as heat by NPQ. They are tagged with numbers to help referencing in the text (①,...,⑩).

How can we reassess these questions in a more contemporary and more efficient way? As previously noted, the number of absorbed photons is very difficult to measure, and makes the measurement of quantum yield somehow difficult to reproduce between different instruments or researchers (see for example the controversy between Emerson and Warburg). One way to circumvent this problem is to measure the number of electrons transferred per photosystem (and that, Emerson was aware of when he designed his flash-experiment [61]).

Chlorophyll fluorescence has proven to be a very useful tool to sample for photosynthetic activity in relation to light, to relate back to O₂ evolution and CO₂ uptake (figure 20). Chlorophyll fluorescence is inversely proportional to photochemistry, that is electron transfer (qP) or open PSII centers [62].

$$qP = (F_{M'} - F) / (F_{M'} - F_0')$$

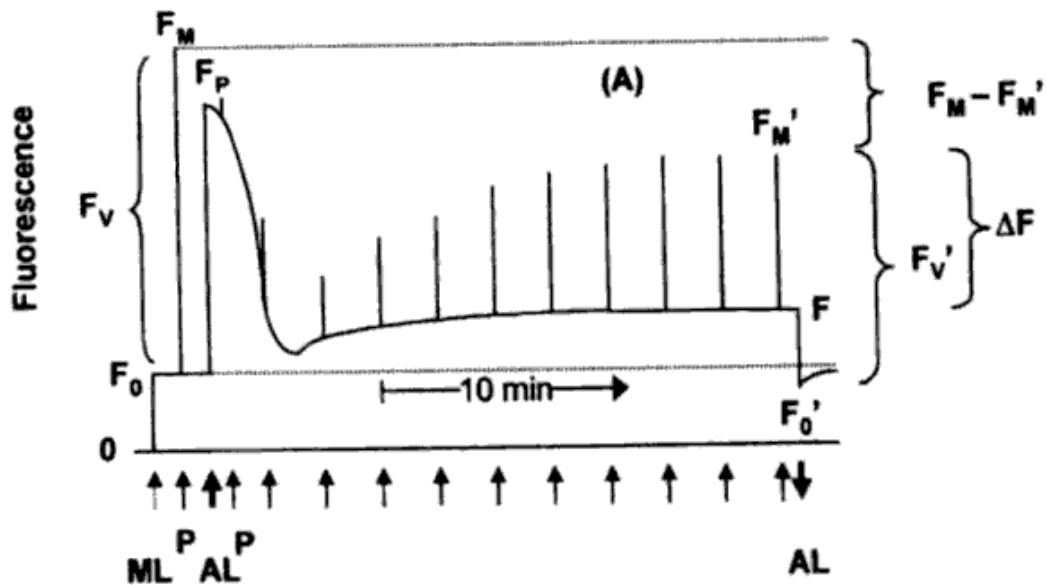

Figure 20. Determination of F₀ and F₀' in weak modulated measuring light (ML), of F_m and F_m' by means of saturating light pulses (P) and of photochemical quenching (qP) and non-photochemical quenching (NPQ) and photosynthetic yield of PSII (ϕ_{PSII}) under moderate continuous light (around 300 $\mu\text{mol m}^{-2} \text{s}^{-1}$) and repetitive saturating pulses (P) on a plant leaf. $F_V = F_M - F_0$; $F_V' = F_{M'} - F_0'$; $\Delta F = F_{M'} - F$. [62]

Another similar expression often used as a measure in chlorophyll fluorescence is ϕ_{PSII} , referring to the proportion of light absorbed by PSII and used in photochemistry [63]:

$$\phi_{\text{PSII}} = (F_{M'} - F) / F_{M'}$$

The quantitative addition to chlorophyll fluorescence measurements is the addition of DCMU to the sample. DCMU blocks the PQ binding site Q_B in PSII so electrons end up on the acceptor Q_A . When cells are poisoned with DCMU we can calculate the electrons transferred to Q_A (as an aside, this is not linear with the fluorescence rise because we have to take into account the connectivity between PSII centers [64]). This gives us the rate of the initial Fluorescence, F_{ini} .

At a stationary phase of photosynthesis in the light F' we can calculate the number of electrons transferred and we can infer the number of CO_2 molecules fixed because we know that 4 electrons are required for oxidation of H_2O and thus the fixation of 1 CO_2 molecule :

$$\begin{aligned} F_{\text{stat}} &= F_{\text{ini}} \times \phi_{\text{PSII}} \\ &= 100 \times 0.3 \\ &= 30 \text{ e}^- \cdot \text{s}^{-1} \cdot \text{PSII}^{-1} \end{aligned}$$

30/4 electrons :

$$\approx 8 \text{ CO}_2 \cdot \text{s}^{-1} \cdot \text{PSII}^{-1}$$

For the comparison of our data, directly expressed in electrons transferred per second per photosystem ($\text{e}^- \cdot \text{s}^{-1} \cdot \text{PSII}^{-1}$), with other metabolic studies where rates are usually expressed in μmol of metabolite. $\text{hr}^{-1} \cdot \text{mg Chl}^{-1}$, we have estimated that for a concentration in PSI of 50 nM (measured spectroscopically), the chlorophyll content was typically 45 μg of Chl/ml [65]. Given that 1 mg of Chl is approximately equal to 1.1 μmol of Chl, 45 μg of Chl/ml corresponds to 49.5 μM Chl, i.e. 1000 times more than PSI, consistent with other reports [66]. It provides us with the formula: $1 \text{ e}^- \cdot \text{s}^{-1} \cdot \text{PSII}^{-1} \approx 4 \mu\text{mol of e}^- \cdot \text{h}^{-1} \cdot \text{mg Chl}^{-1}$ (electrons per hour per mg Chl).

This is useful because it relates electron transport to a metabolic measurement and holds

true in *Chlamydomonas* at low light intensities. We devised this equivalence in 2012 [67]. Finally then, we can also formulate electron transfer in terms of a metabolic flow :

$$80 \text{ e}^- \cdot \text{s}^{-1} \cdot \text{PSII}^{-1} = 80 \text{ mol O}_2 \cdot \text{h}^{-1} \cdot \text{PS}^{-1}$$

In response to the last question, how can we measure an improvement in photosynthesis, based on the above reasoning we can use chlorophyll fluorescence and its multiple associated equations to provide us with a practical and non-invasive tool for the laboratory and field. The final proof of an improvement in photosynthesis should be its relation to an increase in growth of the photosynthetic organism related to increased CO₂ fixation, this is called photosynthetic productivity. We have developed a system to measure photosynthetic productivity using controlled conditions in photobioreactors with online measurements of optical density to measure cell growth and CO₂ uptake by infra-red measure (LICOR). This was funded by an award from the INSIS Cellule Energie Unit of the CNRS for a project based on the concept of *Chlamydomonas* domestication for improved phototrophic biomass production. This was reported in Chaux et al., 2015 [68].

What limits photosynthesis ?

Let's rephrase the question, If we consider photosynthesis under ideal conditions, high humidity, optimal (rather low) light and no nutrient limitation what is it that sets the upper limit for the fixation of CO₂ and thus growth or reserve storage? Leaf gas exchange experiments give us the background for answering this question. Figure 21 of an Assimilation/ intercellular (A/Ci) curve neatly illustrates the problem, a measured rate of CO₂ fixation is at the intersection of the limitation imposed by RuBisCO meeting the limitation imposed by the electron transport rate at a given light intensity. RuBisCO is limited at low CO₂ concentrations by its competing oxygenation reaction while electron transfer is limited by the turnover of RuBP which is dependent on NADPH and ATP from the light reactions [69].

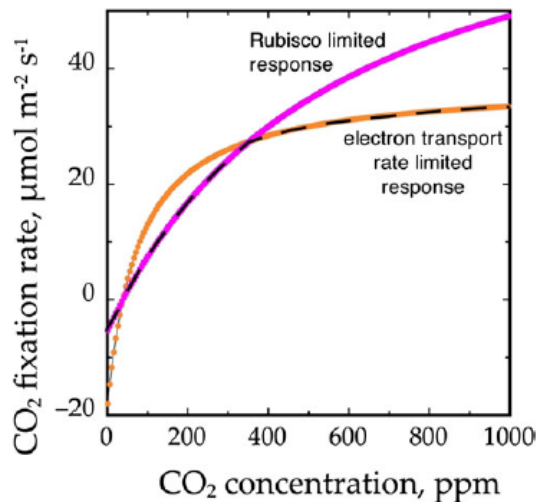

Figure 21. For plants: the relationship between CO₂ concentration at the site of carboxylation (i.e. the chloroplast stroma) and the rate of CO₂ fixation, commonly referred to as an A/Ci curve, for a leaf in an atmosphere containing 21% (21pKa) oxygen. The rate of CO₂ fixation is the minimum of either the Rubisco-limited rate (the A_c line) or the ribulose-1,5-bisphosphate-limited rate (the A_j line). The supply of ribulose-1,5-bisphosphate is strongly influenced by the rate of electron transport and thus irradiance, so for any leaf there are an infinite number of possible A_j lines, corresponding to different irradiances (only one is illustrated). The A_c line is determined by the amount of Rubisco, its activation state and temperature, so if the Rubisco is fully activated and temperature is constant there is only one A_c line. Copied from <http://plantsinaction.science.uq.edu.au/content/case-study-11-development-aci-curves>

In recent years some key points in metabolism and electron transfer have been identified as imposing this limitation on RuBP turnover. For metabolism they are the Calvin Cycle enzymes, SBPase and RuBisCO. RuBisCO is limited by its maximum Carboxylation rate ($V_{c,max}$) while the turnover of RuBP is linked to electron transport (J_{max}). If we look back to figure 19 (A/Ci) we see that with future rises in global CO₂ concentrations, it's the electron transport rate dependent curve that will limit CO₂ assimilation and not RuBisCO activity. SBPase is the first step in the regeneration of RuBP (dephosphorylation of SBP to S7P). In tomato, wheat and tobacco overexpressing SBPase has positive effects on grain yield, temperature and drought stress thus positive effects on photosynthesis. Similarly, under expressing SBPase has a linear effect on decreasing CO₂ assimilation. Interestingly, while the improvements linked to SBPase are associated with increased RuBP turnover, consistently linked to increased electron transport, J_{max} is not always affected in SBPase over expressers with higher CO₂ assimilation [70-72]. Modeling studies have been instrumental in showing the importance of SBPase in RuBP turnover, the expected returns are won from its overexpression and yet the link to electron transfer cannot be full established.

The electron transfer chain complex, *cyt b₆f*, has been identified as limiting for electron transport [73]. As opposed to the photosystems, the *cyt b₆f* plays a central role in control of photosynthetic yields because :

1. kinetically it is the rate limiting step in electron transfer
2. the interaction with the PQ pool via the Q cycle, as intermediate before PC electron donation towards PSI,
3. as the docking site of the kinase responsible for state transitions redistributing light harvesting complexes,
4. participation in linear and cyclic electron flows.

No surprise that the overexpression of a *cyt b₆f* subunit PetC induced not only higher accumulation of *cyt b₆f* complex but also PSI and PSII complexes, as if a retrograde control imposed a greater accumulation of the light capture complexes to keep up with the capacity of the *cyt b₆f* as its rate increased [74]. The study of the *cyt b₆f* is a key theme in our studies and we have current projects aimed at improvement or understanding of photosynthetic regulation by synthetic biology techniques [75].

The control on rates of linear electron flow exerted at the level of the *cyt b₆f* is known as photosynthetic control. The key to this control is the protonation of a Histidine residue in the Q_o site of the reiske protein impeding oxidation of PQH₂. This means electron transfer at the Q_o site is pH dependent. As the thylakoid lumen becomes progressively acidified due to electron transfer this will thus result in a slowing down of electron transfer at the level of the *cyt b₆f* complex, a reduction of the PQ pool also leading to activation of the STT kinase and reduction of Q_A in PSII. Photosynthetic control is induced by the PGR5-PGRL1 cyclic electron flow pathway that contributes to increase the proton gradient across the thylakoids and acidifies the lumen because the amount of H⁺ per e⁻ is greater (1 for 1) than for linear electron flow (12 for 8). Cyclic electron flow thus stimulates PS control and qE type NPQ. PGR5-PGRL1 CEF is redox regulated and interacts with thioredoxins, responding to high NADPH :ATP ratios. ATP synthase conductivity, that is the relation between the ATP synthase proton pump (F₀) and catalyzer of ATP synthesis (F₁) is affected depending on pH gradient, referred to as the ΔμH⁺. ATP synthase is regulated primarily by substrate availability, ADP and Pi, so the turnover of Calvin Cycle intermediates, their export and the import of carbon

into the plastid will all feed back and forward on photosynthetic control.

In Figure 21, infinite curves could exist for the electron transport rate limited response (A_j) because they are irradiance dependent (just one is represented on this graph), with increasing light the limitation for the supply of NADPH and ATP lessens and increases CO₂ fixation and the A_j curve will be pushed upwards. However, with increasing light, photoprotective mechanisms come into play and again limit CO₂ fixation and this intensifies if other factors such as water are also limiting. See figure 22 below.

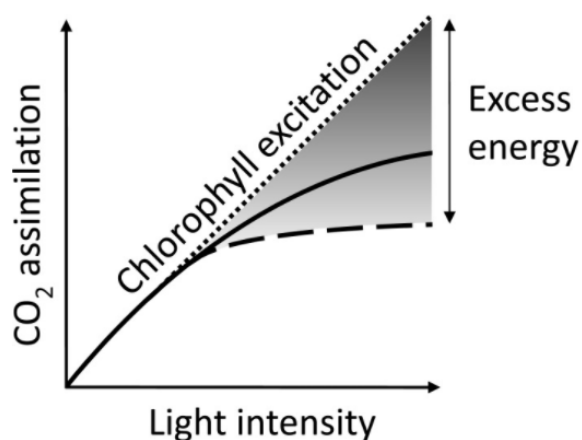

Figure 22. NPQ limits the CO₂ assimilation curve at high light intensities (Niyogi et al., 2002).

Photoprotection and photosynthetic control supply signals for acclimation of the photosynthetic apparatus and downstream metabolic reactions. Acclimation is the process in which an individual organism adjusts to a change in its environment (in the case of photosynthetic organisms a change in light intensity, temperature, humidity, or pH), allowing it to maintain performance across a range of environmental conditions.

When I arrived in the laboratory LB3M under the direction of Dr. Gilles Peltier, I began to tackle the question of what limits photosynthesis. During this period, I contributed to the characterization of *pgr1* to characterize the exact nature of the alternative pathways that compensate for ATP limitation in the absence of cyclic electron flow [76]. I was also involved in the work of Frederic Chaux, as co-supervisor of his thesis, where he used the photobioreactor set up in the lab to understand the interplay between cyclic electron flow and NPQ [68]. Having noted the main observable from the double mutant lacking both NPQ and cyclic electron flow, *pgr1 npq4*, was an acute PSI acceptor side limitation leading to

photoinhibition of PSI, we wrote a review on PSI photoprotection together [77]. Frederic also undertook a new mutant library in the *pgr1* mutant background where he used a newly acquired Beal SpeedZen chlorophyll imaging set up to screen for double mutants that deviated from the *pgr1* chlorophyll fluorescence phenotype, hoping to find mutants in alternative electron transfer pathways. Interestingly, he found a mutant in the biogenesis of the PSII core complex (manuscript in preparation), a finding that supports the idea that reducing linear electron flow can complement a defect in cyclic electron flow, as was suggested in his study on the *pgr1 npq4* mutant.

An increase in productivity does not necessarily have to correspond to a constant and stable increase under all light or environmental conditions, as seen for the SBPase over expressers, but rather to small increases that can be gleaned from the inhibition of certain overly conservative processes that limit photosynthetic productivity in its transition between periods of stress (light, water, pH, nutrient) towards periods of environmental stability. A good example of this is the recent work showing that reducing the time of relaxation of the qE type NPQ response leads to increases in plant productivity in the field of up to 15% [78].

Can we domesticate green algae? Can we improve photosynthesis in plants ?

As a molecular geneticist my angle for making photosynthesis more productive is by a domestication approach using selection and mutation (i.e. genetics) or by synthetic biology, that is by the addition of valuable genetic traits at higher expression levels or with altered or novel activities. The mission of our institute is to promote photosynthetic organisms as a promising renewable resource for the production of molecules with high added value. Until present microalgae has been little used because yeast and bacteria grow faster in bioreactors and are easier to manipulate and in the case of a renewable vector, crop plants have been a simpler choice due to their cultivation by traditional farming methods. Technological advances in process engineering now allows for the cultivation of microalgae from small to large-scale photo-bioreactors. While the output from heterotrophic cultures (microalgae fed with sugar) can achieve substantial yields, photoautotrophic production (with sunlight as the only energy intake), a strictly renewable culture condition, gives satisfactory but limited returns. It is now widely believed that it is possible to increase the production yields of algal biomass (and also plants) by a better understanding of the

limitations and metabolic energy constraints of these organisms. A future challenge is to domesticate microalgae for monoculture as mankind has already done for cereal crops in the past. The ease and speed of transforming, crossing and characterising *Chlamydomonas reinhardtii* also makes it an interesting model for photosynthesis and for translational approaches, that is mutants and synthetic transformants could be discovered and characterised in *Chlamydomonas* with a short turnover time to identify key characteristics and then the same genes could be manipulated in model or crop plants with an aim to find key conserved candidates for yield improvement in agriculture.

What are the major alternative pathways at work in microalgae ? How can we identify them ? Do they limit or optimise photosynthesis ? Understanding photosynthetic control at the molecular level...

In phototrophically grown cells, carbon from CO₂ is used for all the processes of the actively dividing cell from creating building blocks, such as amino acids, nucleic acids and structural lipids, to storage molecules (starch or neutral lipids). The metabolic reactions of CO₂ fixation strongly depend on supplies of reductant and ATP to drive them forward. Metabolites act as sinks for the energy that can be assimilated by photosynthetic energy transduction reactions. Metabolism is coordinated with other alternative electron transfer pathways downstream of photosynthetic electron transfer that fulfills a necessary role both for ATP synthesis and redox balancing and has been shown to act as photoprotective valves. The metabolism of *C. reinhardtii* is characterized by a strong intracellular compartmentalization showing clear homologies with the metabolism of plant cells, where compartmentalization is a key determinant of metabolic efficiency. The examination of the structure and compartmentalization of *C. reinhardtii* metabolism is therefore critical to understand the basis of carbon and energy storage in microalgae and higher plants which we performed via literature search of -omics datasets and literature mining, see Figure 23 from [79].

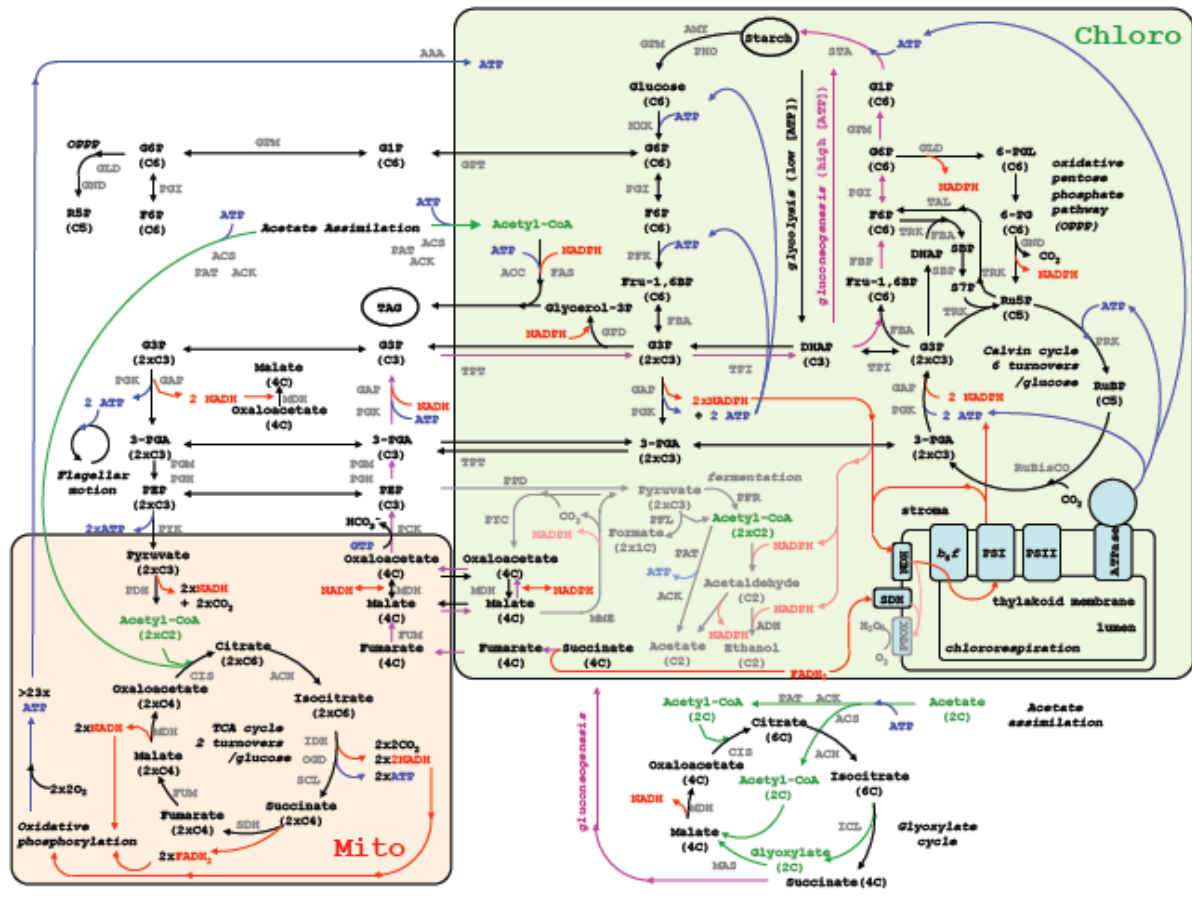

Figure 23. Shows the complex interaction between the phototrophic and respiratory energy budget of ATP and NAD(P)H in *Chlamydomonas*. Special attention has been placed on the expected compartmentalization of these reactions [79].

It is quite obvious that any study of alternative electron transport must include a deep consideration of metabolism, and it was clear to us that my projects relating to alternative electron transfer in *Δrbcl* required this approach at the experimental level. We began with some simple questions to start dealing with the amplitude of the interactions at hand. We carefully considered how differences in ATP:NADPH ratios impact on downstream metabolic partitioning, for example, the requirements for starch synthesis are different from those for lipid synthesis [79]. This is most relevant though under conditions where light intensity exceeds what the metabolic reactions can process in terms of NADPH and ATP delivered from the photosynthetic electron transfer chain. We examined how photosynthate, exogenous carbon sources and reserve carbon is processed in the cell using an *in vivo* method based on P₇₀₀ oxido-reduction measurements [67]. What was obvious from the literature and our own experiments is that there is an absorption of excess energy into

metabolic reactions in the chloroplast and an important energy exchange between the chloroplast and the mitochondria.

In 2014 we finished the characterisation of the *pgr5* mutant (started from the GreenCut project) showing that PGR5 protein was indeed required for cyclic electron flow in *Chlamydomonas* (the light reaction pathway that generates ATP by the recycling of NADPH) as in *Arabidopsis* [52] despite previous reports suggesting it was not required because unlike us they had not been able to detect the protein [80]. This work showed that *pgr5*, like *pgr1*, (also affected for photosynthetic cyclic electron flow) relies on O₂ as a terminal electron acceptor to supplement ATP deficiency and that allows them to show normal growth at high CO₂ levels despite their mutation but will grow poorly on ambient CO₂ [76]. From our perspective we were interested to know what form of regulation comes into play in the absence of PGR5 in severe ATP deficiency or deregulation of *pmf* or under strong redox conditions when NADPH should be over-accumulated. We created the double mutant combination, *pgr5* Δ *ATPase* to answer the first question and *pgr5* Δ *rbcl* (no PGR5-Fd cyclic electron flow and no RuBisCO i.e. no CO₂ fixation) for the second question. In the latter mutant, O₂ can substitute entirely for CO₂ fixation to drive photosynthetic electron transport and possesses a striking chl fluorescence kinetic that shows a phiPSII equivalent to the single *pgr5* mutant (figure 24). Using gas exchange experiments at the LB3M with Pierre Richaud (Membrane Inlet Mass spectrometry) we could show photosynthetic reductants are shuttled towards the mitochondria in the double mutant where they are oxidised for ATP production, therefore compensating the *PGR5* mutation [52].

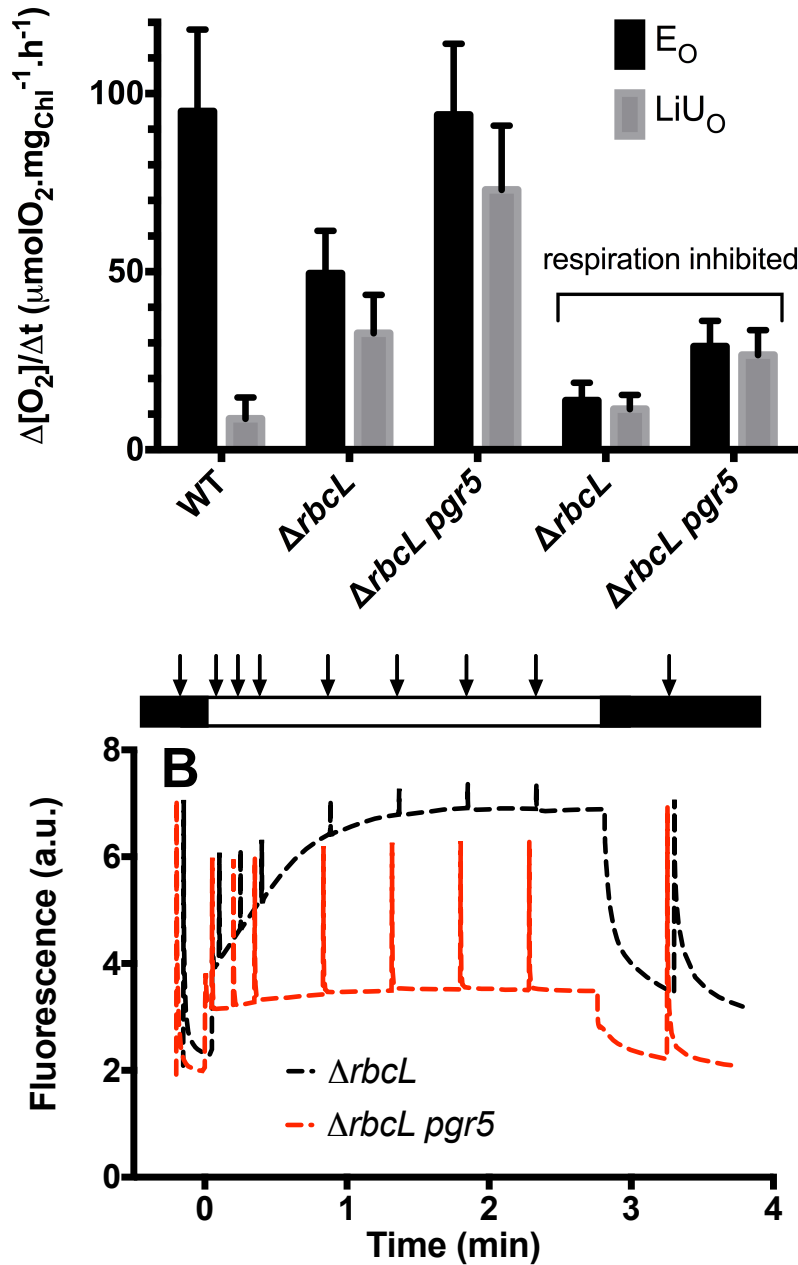

Figure 24. A. Gas exchange measurements using membrane inlet mass spectrometry with labeled O_2 to discriminate respiratory and photosynthetic fluxes between the WT, $\Delta rbcL$ and $pgr5\Delta rbcL$ strains. The y axis shows the rate of E_o or LiU_o corrected for U_o normalized to the chlorophyll content of the cells. The x axis shows the different strains tested. Respiratory inhibitors (20 mM myxothiazol and 200 mM SHAM) were added to measure the proportion of O_2 exchange attributable to light-induced mitochondrial respiration. B. Fluorescence kinetics of $\Delta rbcL$ and $pgr5\Delta rbcL$, grown in TAP media at low light intensities. Analysis was performed by a JTS-10 with an actinic light of 100 microE, saturating flashes at 5000 microE.

In plants this pathway is known to be regulated at different levels by: accumulation of reductants, thioredoxins and by the accumulated levels of metabolites such as malate and triose phosphate and the stimulation of their transporters, for our most recent review see [60], however we do not know many of the molecular players in *Chlamydomonas* because

we do not have the mutants. Of equal importance, this result showed that in the presence of PGR5, cyclic electron flow was causing the increase in steady state fluorescence that I had witnessed in the rubisco-less mutants since working on *mrl1*. This showed that cyclic electron flow was imposing photosynthetic control on linear electron flow, the acidification of the lumen leading to protonation of cyt *b₆f* and slowing down linear electron flow leading to a strong reduction of the PQ pool. Without this control and without CO₂ fixation, electrons, issue of linear electron flow, were free to follow their dangerous course unimpeded towards oxygen.

From these observations a new idea of how to isolate the molecular players of alternative pathways linked to metabolism and photosynthetic control were born. I was awarded finance by the ANR for the project ChloroPaths for 4 years in 2014. The principle of the project based around a new mutant screen is simple. Using a mutant strain devoid of RuBisCO, *ΔrbcL*, as the recipient strain for genetic transformation, we screened for new mutants (double mutants) using a video imaging system of chlorophyll fluorescence. Based on our previous experience on the single *ΔrbcL* mutant, we know that alternative metabolic pathways appear to act as exhaust valves for the excess electrons. Therefore, using the *ΔrbcL* mutant strain as a genetic background is a way to observe genetic interactions via a secondary mutagenesis because we should target bypass metabolic reactions (generation of *Δxxx ΔrbcL* double mutants). Once disrupted and characterised genetically, the metabolic modifications can be reintroduced into a normal photosynthetic system by backcross with a wildtype strain to recover RuBisCO activity (*Δxxx* single mutants). At this stage, an increase in CO₂ fixation is expected in the single *Δxxx* mutants. This is an ultimate aim in our study and it seemed a feasible goal: while in the wildtype photosynthetic electron flow is split between the Calvin cycle and alternative pathways, the obstruction of the alternative pathways could well translate into an increase in CO₂ fixation. I also required a collaborator that could accurately measure photosynthetic metabolites from alga, here I have attracted Stephanie Arrivault from Mark Stitt's group at the Max Planck Institute, Golm for the analysis by GC-MS of our phototrophic metabolites in the Rubisco-less mutant.

Thus the major aim of the project is to use mutant based techniques linking photosynthesis to metabolism and metabolite analysis to give an integrated description of the interaction

between photosynthesis (energy-producing reactions), carbon metabolism (energy storage reactions) and respiratory metabolism (energy-consuming reactions).

Using the Rubisco-less background, $\Delta rbcL$, I generated a strain $\Delta rbcL$ 2A mt- as the background strain for the new library of double mutants. This background strain was highly transformable, fecund and had a higher tolerance to light than the standard Rubisco-less strains. I generated a library of over 10000 insertional mutants that were screened by chlorophyll fluorescence imaging for an increase in ϕ_{PSII} after a 5 minute illumination. Some 17 mutants were isolated and found to have reproducible phenotypes. The mutants were subjected to gene identification by PCR-based techniques, genetic linkage and/or complementation. From this group, 4/17 mutants from the library have an insertion site that could be confirmed and linkage of this insertion site to the chlorophyll fluorescence kinetics established :

1. CGL14, Vitamin B5 co-factor implicated in acetyl CoA production, cytosolic
2. TPT5, Triose phosphate translocator (1 of 18 gene models with TPT domains in Chlamydomonas, none have been characterised at the molecular level).
3. CGL11, 17kDa luminal protein
4. APE1, transmembrane thylakoid protein

For 4/17 mutants linkage was confirmed but the insertion site was badly annotated, for 3/17 mutants insertion site was identified but there was no linkage and for 4/17 mutants no results were obtained using PCR-based techniques and for 3/17 mutants the insertion site has been identified but linkage has not yet been established :

1. SEBP2 cytosolic, key control enzyme in Oxidative pentose phosphate pathway
2. MATE-type Efflux Pump, transmembranaire
3. Det1 : de-etiolated 1, developmental regulator in response to red light, chloroplast targeted in Chlamydomonas

The identification of inserts and linkage has reached its conclusion in the context of the 4-year funded project so as to concentrate on the in-depth characterisation of two mutants : TPT5 and APE1. We chose these two mutants because they represented two different types of downstream control on photosynthetic yields: APE1 is in the thylakoids while TPT5 is a homologue of transporters required for the shuttling of phosphorylated metabolites

between different compartments. Complementation, linkage analysis, backcrossing and outcrossing have been completed for these two mutants. Fine mapping of both sides of the insertion site is completed. Mutants from the Stanford collection have provided extra alleles for these mutants and have also been backcrossed to our wt and $\Delta rbcL$ lines : APE1 is a green cut protein, conserved from cyanobacteria to higher plants, while TPT5 is conserved in *Chlamydomonas* and *volvox* and distantly related to golgi UDP-mannose transporter in plants.

In our studies we have used the $\Delta rbcL$ background not only for the screen but also to putatively assign a function for these proteins because the double mutants highlighted the genetic interaction and the associated phenotype. We have then backcrossed them to restore RuBisCo accumulation to witness their phenotypes and function in the presence of the complete photosynthetic process using the wildtype or complemented lines as control strains for our observations.

Triose-Phosphate Translocator 5: a tool to study the effects of metabolite compartmentalization on photosynthetic yields

TPT5 (annotated in JGI *Chlamydomonas* genome V5.5 as Triose-Phosphate Translocator 5) has high homology to transmembrane proteins that shuttle phosphorylated carbon compounds between the chloroplast and the cytosol. This protein shares homology to the well-characterised GONST (Golgi Nucleotide sugar transporter) from higher plants. The TPT5 protein also shares homology with canonical sugar phosphate transporters in specific domains recognised as facilitating sugar binding. The determinants for targeting to the chloroplast envelope are not well understood and probably lie within one of the transmembrane helices because a recognisable and conserved N-Terminal targeting sequence for chloroplast membrane transporters has not yet been identified. Using GFP constructs fused to the C-terminal of the full length TPT5 protein we could show that TPT5 is targeted to the envelope of the chloroplast (Figure 25). We have generated an antibody against a TPT5 peptide sequence and verified by western blot that the accumulation of TPT5 protein is at 57 kDa and is at very low levels (<5% of WT) in the *tpt5rbcL* mutant line. Complementation with the native TPT5 genomic region containing a 1000 bp upstream of the start site, shows a reaccumulation of TPT5 protein.

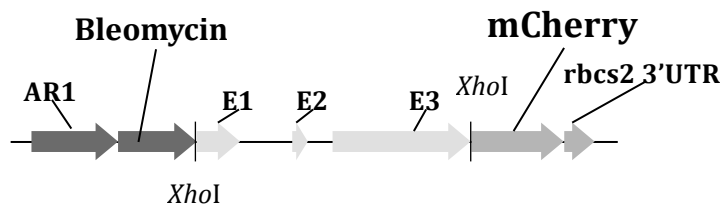

**C-terminus TPT5::mCherry fusion
7237 bp**

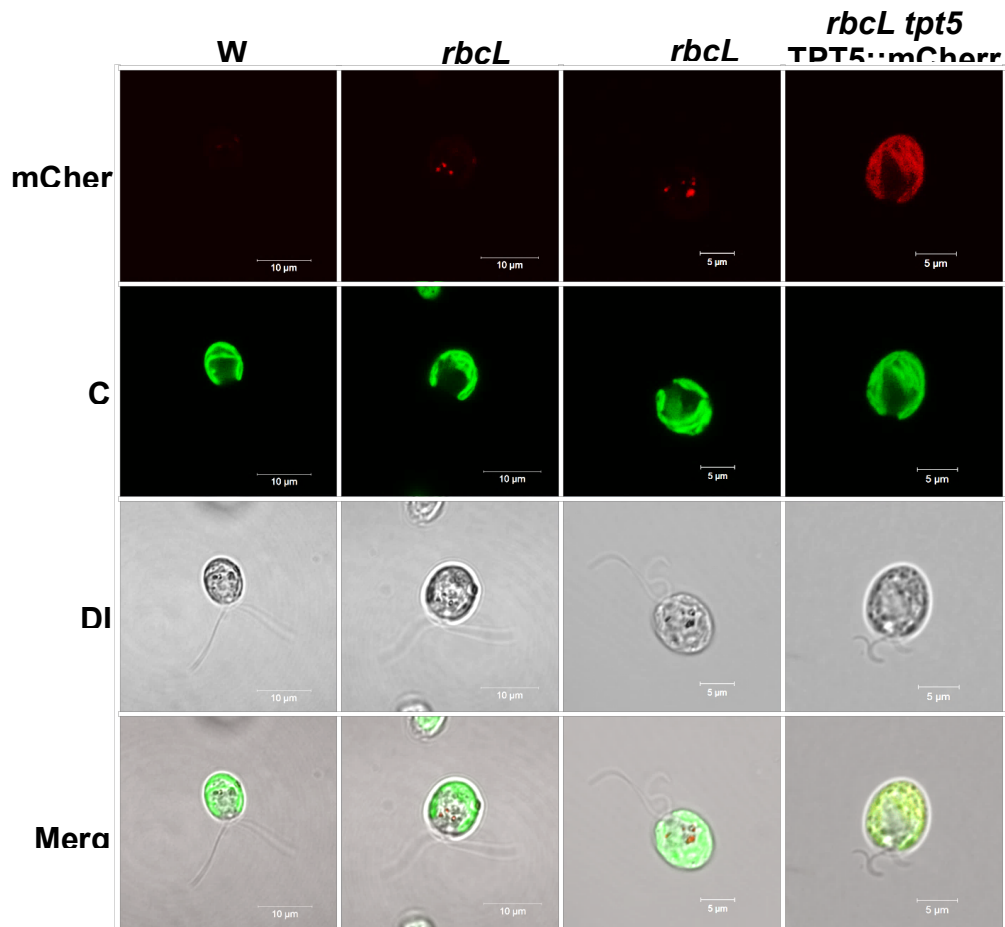

Figure 25. The *tpt5ΔrbcL* mutant was transformed with a fusion construct: with constitutive HSP70A-RbcS promoter, *ble* resistance to zeocin, self-cleaning peptide, *TPT5*, fluorescent reporter mCherry and *rbcS* 3'UTR. Confocal microscopy was used to visualise targeting of TPT5 to the chloroplast envelope, we used a number of controls because autofluorescence unlinked to the transformation of mCherry in an organelle at the exterior of the chloroplast (microbodies?) could be observed in some cases.

We studied accumulation of TPT5 protein under different growth conditions in the WT. We found that TPT5 accumulation increases in conditions where ATP is deficient in the chloroplast: primarily phototrophic high light conditions and anaerobic conditions in the presence of acetate. Starch accumulation and degradation is perturbed in this mutant in the light. ATP levels measured by spectroscopic techniques that probe the activity of

ATP synthase suggest ATP levels are changed or conductivity of ATP synthase is affected presumably due to ADP/Pi levels in the chloroplast, this finding explains in part why we isolated this mutant in the $\Delta rbcL$ background and sheds new light on the mechanisms of photosynthetic control. These results are in line with a function for TPT5 in metabolite shuttling. They will be correlated to metabolite analysis to allow us to know which metabolite(s) TPT5 is transporting across the envelope in the light.

Brzezowski P, Chazaux M, Arrivault S, Peltier G, Alric J and Johnson X. *Mapping the interface between metabolism and photosynthesis using genetics and metabolite profiling.* (in preparation).

APE1: a regulator of lateral heterogeneity of Photosystems I and II in the thylakoids of *Chlamydomonas reinhardtii*

We mapped an insertion in the gene *APE1* (annotated in JGI *Chlamydomonas* genome V5.5 *Acclimation of Photosynthesis to the Environment 1*), conserved in all oxygenic photosynthetic organisms, and we identified the corresponding 25 kDa protein. Almost nothing is known about the function of this protein, which has been previously identified in a genetic screen on *Arabidopsis* but not further studied (Walter et al. 2003)

Photosynthetic yield in the *ape1* $\Delta rbcL$ is greater measured by chlorophyll fluorescence or oxygen evolution than in *rbcL* while the measured electron flow which takes into account electron transfer through both PSI and PSII was equivalent to *RbcL*. This result tells us that repartitioning between linear (PSI and PSII dependent) and cyclic electron flow (only PSI dependent) is changed in the absence of *ape1* in the $\Delta rbcL$ background: the *ape1* $\Delta rbcL$ mutant has a higher rate of linear electron flow during a dark to light transition. We have verified that the cyclic electron capacity in the presence of inhibitors is still active and has an equal rate as the control. Thus the *ape1* mutation does not directly affect the process of cyclic electron flow but rather the conditions that allow cyclic electron flow to function under steady state conditions. The *ape1* $\Delta rbcL$ mutant is more photosensitive than its parent suggesting that it has lost a photoprotective mechanism (potentially related to the implementation of cyclic electron flow) allowing its survival in this mutant context.

We have generated APE1 recombinant protein and have a specific antibody. We have localised APE1 to thylakoid membranes in the chloroplast. The *rbcl ape1* mutant has trace levels of APE1 protein and the complemented line shows a linkage between the chlorophyll fluorescence phenotype and the accumulation of the APE1 protein. The *rbcl ape1* mutant has been backcrossed into a wildtype line and complemented. We have also found another *ape1* allele in the 4th intron of the APE1 gene from the CLiP library (<https://www.chlamylibrary.org/>) that we ordered. Our antibody verified that this mutant accumulated no APE1 protein. After a number of backcrosses and complementation of this allele, we have named this allele *ape1-2*.

APE1 has been determined as a highly abundant thylakoid protein that accumulates in stoichiometric quantities to PSII (0.5 APE1 for 1 Qa). APE1 does not seem to be required for biogenesis of PSII because it accumulates in PSII-less mutants and has little effect on total PSII protein accumulation in the *ape1* mutants. APE1 co-migrates with monomeric, dimeric and supercomplex forms of the core PSII protein D1 in native gels. It also co-migrates with forms of PSI that appear as dimers on native gels. We have found that supramolecular organization of PSII and PSI as well as thylakoid structure is altered in the *ape1* mutant. The *ape1* mutant has shorter and more highly stacked thylakoids than the control strain. This reorganization has effects on photoprotective mechanisms; *ape1* mutants are more photosensitive, showing a stronger PSII photoinhibition and sustained singlet oxygen production in the light probed by a significant increase in GPX5 accumulation. However, the *ape1* mutant can maintain phototrophic growth in high light and shows an increase in CO₂ fixation of around 30% compared to the wildtype grown phototrophically in low light. Furthermore, APE1 is redundant in conditions where CO₂ is not limiting. This suggests that APE1 has a role in regulation of the photosynthetic apparatus rather than in biogenesis or PSII repair. The APE1 protein is potentially a sensor of changes in light and metabolism.

In plants and algae, PSII super-complexes accumulate in low light to optimize light capture and in response to a high light shift are rapidly reduced in favour of PSII sub complexes associated with PSII repair; on the contrary, the *ape1* mutant has a shift toward even higher MW forms of both PSII and PSI complexes in low light and retains PSII super-complexes in high light (figure 26).

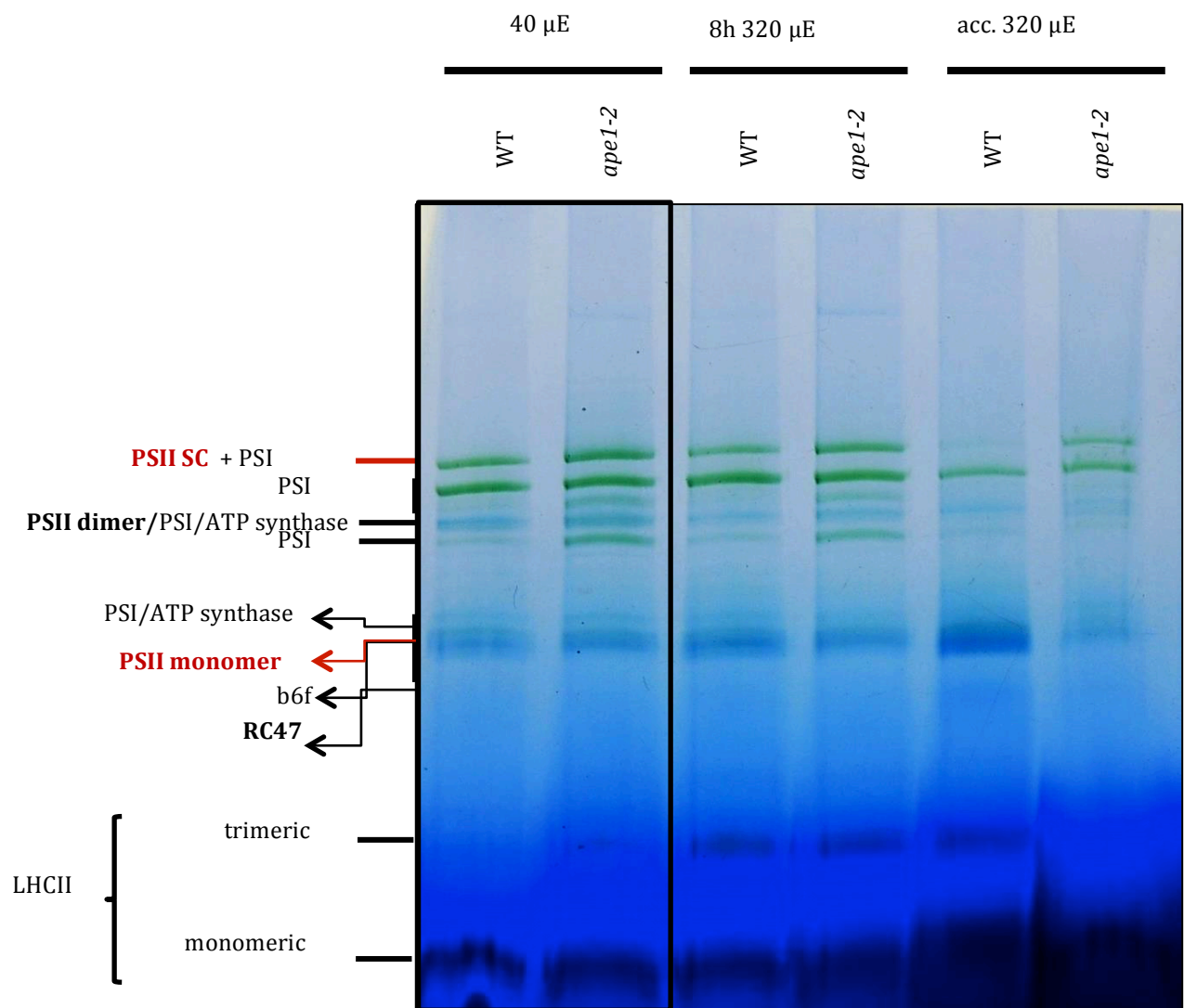

Figure 26. *ape1* has a higher ratio of both PSII and PSI high molecular weight complexes at low light ; APE1 is necessary for mobility of PSII complexes towards low molecular forms in response to an acclimation to high light. BN-PAGE analysis of thylakoid proteins from wildtype and *ape1-2* cells acclimated at low light in photobioreactors, after 8 hours in high light and acclimated at high light in photobioreactors. Thylakoid membrane proteins were solubilized using 1% β -DM for 5 minutes on ice and separated by BN-PAGE. Proteins were loaded on a per chlorophyll basis.

The effect of APE1 on photosystem oligomeric structure and organisation in the thylakoids has energetic repercussions on the partitioning between linear and cyclic electron flow that is a central mechanism in ATP production and photoprotection and links electron transfer towards CO₂ fixation. APE1 is a protein that functions in the supramolecular organization of the photosystems in the thylakoid membranes, to equilibrate photosynthetic fluxes, and this role is dynamic during acclimation processes.

Chazaux M, Alric J, Floriani M, deGraca J, Brzezowski P, Cui n  S, Caffari S, Peltier G, Genty B and Johnson X. *The protein Acclimation of Photosynthesis to the Environment 1 interacts*

with Photosystem II to determine the organization of photosynthetic complexes in the thylakoid membrane of Chlamydomonas . (in preparation)

We are also studying the *Arabidopsis ape1* mutant in collaboration with Stefano Caffari (LGBP) to complement the *Chlamydomonas* work: preliminary investigations of this mutant suggest a detachment of PSII antennas and when the plants are transferred from 100 microE to 400 microE light intensities for a few days and a deregulation of qE and qZ NPQ leading to a decreased observed ETR. This mutant has now been complemented and we now require an antibody to verify our mutant and the complemented lines and to move forward with biochemical analysis.

First (naïve) Conclusions from the ChloroPaths Project

In depth characterisation of the first mutants that we have isolated from this screen that include metabolic effectors (TPT5 and CGL14) and protein regulators at the level of the photosynthetic chain (APE1 and CGL11), suggest that the regulation of the proton gradient is the central regulator in the communication between metabolism and photosynthetic productivity. This would suggest that our mutant library was successful in finding central actors of photosynthetic control and that photosynthetic control has a direct connection to CO₂ fixation. That *ape1* can fix more CO₂ than the wildtype under certain controlled conditions validates the central idea of this project, that is that alternative pathways reduce photosynthetic productivity and that our screen could identify these pathways. Regulators of redox poise, NADPH and shuttling of reducing equivalents may not have been targeted by the approach of using *Δrbcl* as a genetic background. This may mean that the regulation of reducing equivalents is not involved in the optimisation of CO₂ fixation and rather involved in protection in fluctuating light as already proposed for flv, mehler reaction and malate valve [60].

Perspectives

I'm really grateful to Marie and Pawel who have followed me on this path by their identification of the mutant insertional sites and the characterisation of *ape1* and *tpt5*. Their enthusiasm and intelligence has pushed the projet forward. I have made the transition over this period from being the scientist who conceives and performs the experiments and writes the papers, to the one who interacts and guides, spending less time in the laboratory. They have made this transition relatively easy for me and I am thankful to them.

Ideally, I plan to continue with the characterisation of *ape1* and *tpt5* because they hit the machinery of photosynthesis at the level of the thylakoid membrane and at the level of metabolism and exchange with respiration representing the two key points of control for optimising photosynthetic yields. The characterisation of the other conserved proteins where linkage has been established, particularly CGL11 and CGL14 would enrich the model. Long term, the linkage studies on the other 3 mutants (DET1, SEBP2, Efflux Pump) should also be completed. This mutant library has lived up to expectation isolating effectors of photosynthetic yields and acclimation responses.

Two projects that I would like to pursue are offshoots from the ChloroPaths project;

1. Revealing the mechanism of APE1 by a comparative and translational approach using cyanobacteria, algae and plants

We have isolated a mutant of APE1 in *Chlamydomonas* and assigned a putative function using the observables that I described previously in this chapter. Our data show that APE1 controls or modulates supramolecular organization of the thylakoid, photosystem lateral heterogeneity and oligomerisation that is in tune with the environment. We would like to take a translational approach in different oxygenic phototrophs to work towards a mechanism for APE1. The proposal would aim to observe the effects of mutants of *ape1* in an organism that is more simple than *Chlamydomonas*, the cyanobacterium *Synechococcus*, and more complex, *Arabidopsis*. By taking this comparative and translational approach to

what we have already learnt about the function of APE1 in *Chlamydomonas* we will go faster to understand the mechanism of APE1.

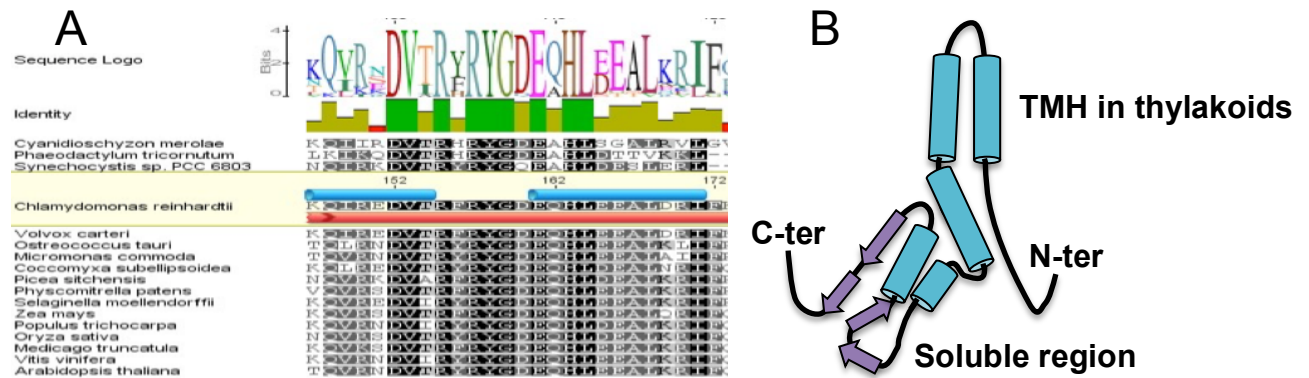

Figure 27. **A. APE1 is a highly conserved protein.** Sequence alignment of APE1 in *Chlamydomonas reinhardtii* (Cre16.g665250.t1.2), against representatives of different clades of oxygenic phototrophs. The size of amino acid lettering signifies the degree of the conservation of this residue across species. Global Alignment programme with Blosum62 cost matrix. **B.** Secondary structure model of the APE1 protein showing predicted transmembrane (RaptorX [83]) helices (in blue) and beta-coil (in purple).

The project would take a three-pronged approach focusing on biochemical techniques:

- A. Cyanobacteria: By the comparison of 350 different cyanobacteria genomes publicly available (JGI) we can already see that APE1 is present in all cyanobacteria that possess oxygenic photosynthesis and APE1 has not been retained in those that have lost the PSII, often due to endosymbiosis. This already suggests a continuity in the function of APE1 in the regulation of photosynthesis through to eukaryotic organisms. We would produce knock out mutants in *Synechococcus* where APE1 is found in an operon with the nitrogen metabolism gene *argB*. This gives us a clue that nitrogen metabolism and acclimation processes are linked in this species. The mutants will be phenotyped to find conditions where APE1 is important. We will perform comparative metabolomics under different conditions to understand where APE mediated acclimation mechanisms play a role in maintaining photosynthetic and metabolic activity in this cyanobacteria.
- B. Green algae:
 - A. bioinformatics analysis has shown us that APE1 has a conserved region of unknown function that has conserved residues in all oxygen phototrophs (figure 27). This region contains, in particular, the acidic residues Aspartate

and Glutamate. We will mutate these residues and test their function in vivo in our *ape1* mutants to identify if pH sensing is involved in the regulation of APE1.

- B. We have performed a thorough phenotypic analysis of the *Crape1* mutant and it has many observables. We would like to dissect which of these observables is directly related to APE1 function and which of these comes from the effects related to retrograde signaling towards the nucleus to reestablish a homeostasis in the chloroplast. Among the observables that appear to indirectly related to APE1 function are chlorophyll content and APE1 accumulation which varies depending on genetic background and growth conditions. To dissect these effects we would perform transcriptomic analysis (RNA-seq) under various conditions and pool the genes that appear to be directly up- or down- regulated in response to an absence in APE1.
- C. Arabidopsis: we already know from our own analysis that APE1 should be strictly related to acclimation mechanisms that have outcomes on the PSII absorption spectra and NPQ mechanisms. It is important for us to know now to what point the Arabidopsis phenotype is similar to that of green algae. What is the plus for us in higher plants versus algae is the organizational properties of the thylakoid membranes that have true grana and lamellae which are modulated during to dark – light- high light growth. Our collaborator, Stefano Caffari has refined techniques for the biochemistry of thylakoid proteins and their solubilisation and separation specifically for supercomplexes. He is also presently developing Microscopy methods (AFM, cryo) for the direct observation of PS organization in the membranes.

2. Compartmentalisation studies on metabolites both in Chlamydomonas and Arabidopsis using the technique of non-aqueous fractionation.

I would like to keep or maintain collaboration with metabolomics platforms who could perform the compartmentalisation studies on metabolites both in Chlamydomonas and Arabidopsis. The technique of non-aqueous fractionation [81] would be developed in both organisms to continue to refine the links between metabolism and photosynthesis, particularly to define compartmentalization during transient changes in light to understand how these different pools regulate and drive photosynthetic light reaction forward. This

would be a continuation of the work that I have already begun in collaboration with Max Planck.

A number of good candidates that are directly related to metabolism have been identified in the $\Delta rbcL$ screen: CGL14, Vitamin B5 co-factor implicated in CoA production; cytosolic. TPT5, Triose phosphate translocator, chloroplast envelope targeted; SEBP2 cytosolic, key control enzyme in Oxidative pentose phosphate pathway; MATE-type Efflux Pump, transmembranaire and could be directly studied in this project.

3. Studies on Oxidative stress signalling and its relation to Biomass production.

In our team, Michel Havaux leads the Oxidative Stress subgroup. He has recently undertaken a genetic screen, which isolated *Arabidopsis thaliana bic* (*bigger than ch1*) mutants where growth limitation by singlet oxygen is suppressed. Here he has identified a disconnection between negative growth regulation imposed by signaling molecules and stress conditions. Some of these genes are linked to phytohormones, by acting on their catabolism or by negatively regulating their signalling, and other interesting candidates are related to sugar sensing. Michel and I envisage a collaboration where we study the same mutant in *Arabidopsis* and *Chlamydomonas* (produced by CrispR/Cas9 or ordered from the CliP library) to witness the effects in both species on biomass production under adverse conditions. As we are using candidates from plants this gene may have a diverged or different function in *Chlamydomonas* and we may have no phenotype related to stress signaling. If this is the case we will concentrate our efforts on the plant mutants. Potentially, This type of photosynthetic productivity approach will be appropriate for projects aimed at the improvement of photosynthesis, such as the proposed EU Flagship consortium Photosynthesis 2.0 or upcoming H2O2 Photosynthesis Proposals.

4. Other paths

The study of the rubiscoless mutant shows that it is a photosynthetic heterotroph. Interestingly, a number of plant tissues have a comparable metabolism. Trichomes have a very low Calvin cycle activity and instead import sucrose and shunt their reducing power and ATP towards the production of terpenoids [82]. Similarly the Rubiscoless mutant may be a potential genetic background for the engineering of high-value added products such as

terpenoids or hydrogen. Preliminary studies in the *rbcl* and *rbcl pgr5* mutant background show that it is indeed a high H₂ producer. There are also possibilities for us to study pure plant and algae heterotrophic metabolism (roots, cambium) for projects such as « 4pour1000 » based on what we know about heterotrophic metabolism in *Chlamydomonas*.

This project is also relevant as a model for drought stress. Drought stress can be monitored by chlorophyll fluorescence in the field because low hydration and high light leads to stomata closure, lower CO₂ levels in the leaf (C_i) and depressed CO₂ fixation that drives the photosynthetic control response giving high steady state F' levels. This is a transient response because prolonged drought stress will result in photoinhibition and over time will result in low F' yields that approach F₀ ; nevertheless photosynthetic control can be followed in the field and because we have this phenotype as a non-invasive marker, it represents an informative trait to screen for in crops and link to improvements in yield via resistance strategies or changes in photosynthetic productivity. The continued conceptualisation of new machines that probe photosynthetic yields in the field is a major orientation in our Photosynthesis subgroup led by Bernard Genty in our team. This scientific topic is enhanced by the study of mutants because we try to improve our tools and our conceptual models during their study and this in turn feeds back to ideas about new ways to probe photosynthetic productivity. The understanding of the multifactorial and complex traits that tie photosynthetic yields to the environment represents one of the keys to future improvements in crop yields.

7. Bibliography

1. Pavis N, Boucaud J, MP Ph: **Fructans and Fructan metabolising enzymes in Leaves of *Lolium perenne***. . *New Phytologist* 2001, **150**: 83-95.
2. Vijn I SS: **Fructan more than a reserve carbohydrate ?** . *Trends In Plant Science* 1999, **120**:351-359.
3. Volaire F TH, Lelievre F: **Survival and recovery of perennial forage grasses under prolonged Mediteranean drought**. . *New Phytologist* 1998, **140**:439-449.
4. Chalmers J, Johnson X, Lidgett A, and Spangenberg G.: **Isolation and characterisation of a sucrose: sucrose 1-fructosyltransferase gene from perennial ryegrass (*Lolium perenne*)**. . *J Plant Physiol*. 2003, **160**:1385-1391.
5. Lidgett A JX, Terdich K, Guthridge K, Jones L and Spangenberg G.: **The Cloning and Functional Analysis of a Fructosyltransferase cDNA from Perennial Ryegrass**. *J. Plant Physiol*. 2002, **159**:1037-1043
6. Spangenberg G WZ, Nagel J, Potrykus I: **Protoplast Culture and Generation of transgenic plants in red fescue (*Festuca rubra* L.)** *Plant Science* 1994, **97**:83-94.
7. Sprenger N BK, Brandt A, Boller T, Wiemkin A: **Purification, cloning and functional expression of 6-SFT, a key enzyme of fructan synthesis in barley**. . *PNAS* 1995, **107** 1249-1255.
8. Van den Ende W, Van Laere A: **De-novo synthesis of fructans from sucrose in vitro by a combination of two purified enzymes (sucrose :sucrose 1-fructosyltransferase and fructan :fructan &-fructosyltransferase) from chicory roots**. *Planta* 1996., **200**:335-342.
9. Obenland D SU, Boller T, Wiemkin A: **Purification and characterisation of three soluble invertases from Barley leaves**. . *Plant Physiology* 1993, **101**.
10. Chan MT YS: **The 3' untranslated region of a rice alpha-amylase gene functions as a sugar-dependent mRNA stability determinant**. *Proc Natl Acad Sci U S A* 1998, **95**:6543-6547. .
11. Johnson X, Lidgett, A., Chalmers, J., Guthridge, K., Jones L., and Spangenberg, G. : **Isolation and characterisation of an invertase cDNA from perennial ryegrass (*Lolium perenne*)**. *J Plant Physiol*. 2003, **160**:903-911.
12. Spangenberg G LA, Johnson X., Terdich K, Chalmers J. : **Fructosyltransferase homologues from Ryegrass (*Lolium*) and Fescue (*Festuca*) species**., *International Patent PQ8155*. 2002.
13. Panter S, Mouradov A, Badenhorst P, Martelotto L, Smith K, Spangenberg G: **Re-Programming Photosynthetic Cells of Perennial Ryegrass (*Lolium perenne* L) for Fructan Biosynthesis through Transgenic Expression of Fructan Biosynthetic Genes under the Control of Photosynthetic Promoters**. *Agronomy* 2017, **7**:5487-5499.
14. Rameau C BC, Cadier D, Grandjean O, Miard F, Murfet IC **New ramosus mutants at loci Rms1, Rms3, and Rms4 resulting from the mutation breeding program at Versailles**. . *Pisum Genet* 1997, **29**:7-12.
15. Snowden KC SA, Janssen BJ, Templeton KR, Loucas HM, Simons JL, Karunairetnam S, Gleave AP, Clark DG, Klee HJ **The Decreased apical dominance1/*Petunia hybrida* CAROTENOID CLEAVAGE DIOXYGENASE**

- 8 gene affects branch production and plays a role in leaf senescence, root growth and flower development.** *Plant Cell* 2005, **17**:746–759.
16. Sorefan K BJ, Haurogné K, Goussot M, Bainbridge K, Foo E, Chatfield S, Ward S, Beveridge C, Rameau C. : **MAX4 and RMS1 are orthologous dioxygenase-like genes that regulate shoot branching in Arabidopsis and Pea.** . *Genes Dev.* 2003, **17**:1469–1474.
 17. Bennett T, Sieberer T, Willett B, Booker J, Lusching C, O L: **The Arabidopsis MAX pathway controls shoot branching by regulating auxin transport.** . *Curr. Biol.* 2006, **16**:553–563.
 18. Beveridge CA SG, Murfet IC, Ross JJ, Rameau C **The rms1 mutant of pea has elevated indole-3-acetic acid levels and reduced root-sap zeatin riboside content but increased branching controlled by graft-transmissible signal(s).** . *Plant Physiol* 1997., **115**:1251–1258.
 19. Morris SE TC, Murfet IC, Beveridge CA **Mutational analysis of branching in pea: evidence that Rms1 and Rms5 regulate the same novel signal.** *Plant Physiol.* 2001., **126**:1205–1213.
 20. Foo E BE, Goussot M, Foucher F, Rameau C, Beveridge CA. : **The branching gene RAMOSUS1 mediates interactions among two novel signals and auxin in pea.** . *Plant Cell* 2005., **17**:464–474.
 21. Beveridge CA, Ross JJ, IC M: **Branching in pea: action of genes Rms3 and Rms4.** . *Plant Physiol.* 1996, **110**:859–865.
 22. Beveridge CA RJ, Murfet IC **Branching mutant rms-2 in Pisum sativum: grafting studies and endogenous indole-3-acetic acid levels.** . *Plant Physio.* 1994, **104**:953–959.
 23. Stirnberg P vdSK, Leyser HMO **MAX1 and MAX2 control shoot lateral branching in Arabidopsis.** *Development.* 2002, **129**:1131–1141.
 24. Woo HE CK, Park J, Oh SA, Ahn T, Hong SH, Jang SK, Nam HG **ORE9, an F-box protein that regulates leaf senescence in Arabidopsis.** *Plant Cell* 2001, **13**:1779–1790.
 25. Johnson X BT, Dun EA, Goussot M, Haurogné K, Beveridge CA, Rameau C. : **Branching genes are conserved across species. Genes controlling a novel signal in pea are coregulated by other long-distance signals.** . *Plant Physiol.* 2006, **142**:1014-1026. .
 26. Gomez-Roldan V, Fermas S, Brewer PB, Puech-Pages V, Dun EA, Pillot JP, Letisse F, Matusova R, Danoun S, Portais JC, et al.: **Strigolactone inhibition of shoot branching.** *Nature* 2008, **455**:189-194.
 27. Johnson X BD: **The model species, Arabidopsis thaliana.** . *Functional Plant Genomics.* 2007:385-396.
 28. de Saint Germain A, Clave G, Badet-Denisot MA, Pillot JP, Cornu D, Le Caer JP, Burger M, Pelissier F, Retailleau P, Turnbull C, et al.: **An histidine covalent receptor and butenolide complex mediates strigolactone perception.** *Nat Chem Biol* 2016, **12**:787-794.
 29. Ligerot Y, de Saint Germain A, Waldie T, Troadec C, Citerne S, Kadakia N, Pillot JP, Prigge M, Aubert G, Bendahmane A, et al.: **The pea branching RMS2 gene encodes the PsAFB4/5 auxin receptor and is involved in an auxin-strigolactone regulation loop.** *PLoS Genet* 2017, **13**:e1007089.
 30. Boyer FD, de Saint Germain A, Pillot JP, Pouvreau JB, Chen VX, Ramos S, Stévenin A, Simier P, Delavault P, Beau JM, et al.: **Structure-activity relationship studies of strigolactone-related molecules for branching**

- inhibition in garden pea: molecule design for shoot branching.** . *Plant Physiol.* 2012, **159**:1524-1544.
31. Teichmann T, Muhr M: **Shaping plant architecture.** *Front Plant Sci* 2015, **6**:233.
 32. Merchant SS PS, Vallon O et al. : **The Chlamydomonas genome reveals the evolution of key animal and plant functions.** *Science.* 2007, **318**:245-250.
 33. Allen JF, de Paula WB, Puthiyaveetil S, Nield J: **A structural phylogenetic map for chloroplast photosynthesis.** *Trends Plant Sci* 2011, **16**:645-655.
 34. Kuras R S-MD, Wollman FA, de Vitry CA: **Specific c-type cytochrome maturation system is required for oxygenic photosynthesis.** . *Proc Natl Acad Sci U S A.* 2007 **104**:9906-9910. .
 35. Johnson X KR, Wollman FA, Olivier Vallon. : **Gene Hunting in Chlamydomonas.** . *In Proceedings of PSO7 the 14th International Congress of Photosynthesis Research* 2007.
 36. Kuras R dVC, Choquet Y, Girard-Bascou J, Culler D, Büschlen S, Merchant S, Wollman FA: **Molecular genetic identification of a pathway for heme binding to cytochrome b6.** *J Biol Chem.* 1997., **272**:32427-32435.
 37. Raynaud C LC, Wostrikoff K, Kuras R, Girard-Bascou J, Wollman FA, Choquet Y. : **Evidence for regulatory function of nucleus-encoded factors on mRNA stabilization and translation in the chloroplast.** . *Proc Natl Acad Sci U S A* 2007, **104**:9093-9098.
 38. Wang F, Johnson X, Cavaiuolo M, Bohne AV, Nickelsen J, Vallon O: **Two Chlamydomonas OPR proteins stabilize chloroplast mRNAs encoding small subunits of photosystem II and cytochrome b6 f.** *Plant J* 2015, **82**:861-873.
 39. Lurin C AC, Aubourg S, Bellaoui M, Bitton F, Bruyère C, Caboche M, Debast C, Gualberto J, Hoffmann B, Lecharny A, Le Ret M, Martin-Magniette ML, Mireau H, Peeters N, Renou JP, Szurek B, Taconnat L, Small I. : **Genome-wide analysis of Arabidopsis pentatricopeptide repeat proteins reveals their essential role in organelle biogenesis.** *Plant Cell.* 2004., **16**:2089-2103.
 40. Johnson X, Wostrikoff K, Finazzi G, Kuras R, Schwarz C, Bujaldon S, Nickelsen J, Stern DB, Wollman FA, Vallon O: **MRL1, a conserved Pentatricopeptide repeat protein, is required for stabilization of rbcL mRNA in Chlamydomonas and Arabidopsis.** *Plant Cell* 2010, **22**:234-248.
 41. Douchi D, Qu Y, Longoni P, Legendre-Lefebvre L, Johnson X, Schmitz-Linneweber C, Goldschmidt-Clermont M: **A Nucleus-Encoded Chloroplast Phosphoprotein Governs Expression of the Photosystem I Subunit PsaC in Chlamydomonas reinhardtii.** *Plant Cell* 2016, **28**:1182-1199.
 42. Barkan A, Rojas M, Fujii S, Yap A, Chong YS, Bond CS, Small I: **A combinatorial amino acid code for RNA recognition by pentatricopeptide repeat proteins.** *PLoS Genet* 2012, **8**:e1002910.
 43. Miranda RG, McDermott JJ, Barkan A: **RNA-binding specificity landscapes of designer pentatricopeptide repeat proteins elucidate principles of PPR-RNA interactions.** *Nucleic Acids Res* 2018, **46**:2613-2623.
 44. van Rooijen R, Kruijer W, Boesten R, van Eeuwijk FA, Harbinson J, Aarts MGM: **Natural variation of YELLOW SEEDLING1 affects photosynthetic acclimation of Arabidopsis thaliana.** *Nature Communications* 2017, **8**:1421.
 45. Johnson X, Vandystadt G, Bujaldon S, Wollman FA, Dubois R, Roussel P, Alric J, Beal D: **A new setup for in vivo fluorescence imaging of photosynthetic activity.** *Photosynth Res* 2009, **102**:85-93.

46. Johnson X: **Manipulating RuBisCO accumulation in the green alga, *Chlamydomonas reinhardtii*.** *Plant Mol Biol* 2011, **76**:397-405.
47. Houille-Vernes L, Rappaport F, Wollman FA, Alric J, Johnson X: **Plastid terminal oxidase 2 (PTOX2) is the major oxidase involved in chlororespiration in *Chlamydomonas*.** *Proc Natl Acad Sci U S A* 2011, **108**:20820-20825.
48. Gonzalez-Ballester D, Pootakham W, Mus F, Yang W, Catalanotti C, Magneschi L, de Montaigu A, Higuera JJ, Prior M, Galvan A, et al.: **Reverse genetics in *Chlamydomonas*: a platform for isolating insertional mutants.** *Plant Methods* 2011, **7**:24.
49. Grossman AR, Karpowicz SJ, Heinnickel M, Dewez D, Hamel B, Dent R, Niyogi KK, Johnson X, Alric J, Wollman FA, et al.: **Phylogenomic analysis of the *Chlamydomonas* genome unmasks proteins potentially involved in photosynthetic function and regulation.** *Photosynth Res* 2010, **106**:3-17.
50. Heinnickel ML, Alric J, Wittkopp T, Yang W, Catalanotti C, Dent R, Niyogi KK, Wollman FA, Grossman AR: **Novel thylakoid membrane GreenCut protein CPLD38 impacts accumulation of the cytochrome b6f complex and associated regulatory processes.** *J Biol Chem* 2013, **288**:7024-7036.
51. Wittkopp TM, Saroussi S, Yang W, Johnson X, Kim RG, Heinnickel ML, Russell JJ, Phuthong W, Dent RM, Broeckling CD, et al.: **GreenCut protein CPLD49 of *Chlamydomonas reinhardtii* associates with thylakoid membranes and is required for cytochrome b6 f complex accumulation.** *Plant J* 2018, **94**:1023-1037.
52. Johnson X, Steinbeck J, Dent RM, Takahashi H, Richaud P, Ozawa S, Houille-Vernes L, Petroutsos D, Rappaport F, Grossman AR, et al.: **Proton gradient regulation 5-mediated cyclic electron flow under ATP- or redox-limited conditions: a study of Δ ATPase pgr5 and Δ rbcL pgr5 mutants in the green alga *Chlamydomonas reinhardtii*.** *Plant Physiol* 2014, **165**:438-452.
53. Yang W, Wittkopp TM, Li X, Warakanont J, Dubini A, Catalanotti C, Kim RG, Nowack EC, Mackinder LC, Aksoy M, et al.: **Critical role of *Chlamydomonas reinhardtii* ferredoxin-5 in maintaining membrane structure and dark metabolism.** *Proc Natl Acad Sci U S A* 2015, **112**:14978-14983.
54. Kok B: **On the Interrelation of Respiration and Photosynthesis in Green Plates.** *Biochimica Et Biophysica Acta* 1949, **3**:625-631.
55. Brody M, Emerson R: **The quantum yield of photosynthesis in *Porphyridium cruentum*, and the role of chlorophyll a in the photosynthesis of red algae.** *J Gen Physiol* 1959, **43**:251-264.
56. Duysens LN, Amesz J, Kamp BM: **Two photochemical systems in photosynthesis.** *Nature* 1961, **190**:510-511.
57. Emerson R, Lewis CM: **The Dependence of the Quantum Yield of *Chlorella* Photosynthesis on Wave Length of Light.** *American Journal of Botany* 1943, **30**:165-178.
58. Haxo FT, Blinks LR: **Photosynthetic action spectra of marine algae.** *J Gen Physiol* 1950, **33**:389-422.
59. Bonaventura C, Myers J: **Fluorescence and oxygen evolution from *Chlorella pyrenoidosa*.** *Biochim Biophys Acta* 1969, **189**:366-383.
60. Alric J, Johnson X: **Alternative electron transport pathways in photosynthesis: a confluence of regulation.** *Curr Opin Plant Biol* 2017, **37**:78-86.
61. Emerson R, Arnold W: **The Photochemical Reaction in Photosynthesis.** *J Gen Physiol* 1932, **16**:191-205.

62. Hans P: **Pulse Amplitude Modulated Fluorimetry**. In *Light Harvesting Antennas in Photosynthesis*. Edited by Beverley Green WWP: Springer; 2003:513. vol 13.]
63. Genty B, Briantais J-M, Baker NR: **The relationship between the quantum yield of photosynthetic electron transport and quenching of chlorophyll fluorescence**. *Biochimica et Biophysica Acta (BBA) - General Subjects* 1989, **990**:87-92.
64. Lavergne J, Trissl HW: **Theory of fluorescence induction in photosystem II: derivation of analytical expressions in a model including exciton-radical-pair equilibrium and restricted energy transfer between photosynthetic units**. *Biophysical Journal* 1995, **68**:2474-2492.
65. Arnon DI: **COPPER ENZYMES IN ISOLATED CHLOROPLASTS. POLYPHENOLOXIDASE IN BETA VULGARIS**. *Plant Physiology* 1949, **24**:1-15.
66. Neale PJ, Melis A: **ALGAL PHOTOSYNTHETIC MEMBRANE COMPLEXES AND THE PHOTOSYNTHESIS-IRRADIANCE CURVE: A COMPARISON OF LIGHT-ADAPTATION RESPONSES IN CHLAMYDOMONAS REINHARDTII (CHLOROPHYTA)1**. *Journal of Phycology* 1986, **22**:531-538.
67. Johnson X, Alric J: **Interaction between starch breakdown, acetate assimilation, and photosynthetic cyclic electron flow in Chlamydomonas reinhardtii**. *J Biol Chem* 2012, **287**:26445-26452.
68. Chauv F, Johnson X, Auroy P, Beyly-Adriano A, Te I, Cuine S, Peltier G: **PGRL1 and LHCSR3 Compensate for Each Other in Controlling Photosynthesis and Avoiding Photosystem I Photoinhibition during High Light Acclimation of Chlamydomonas Cells**. *Mol Plant* 2017, **10**:216-218.
69. Farquhar GD, von Caemmerer S, Berry JA: **A biochemical model of photosynthetic CO₂ assimilation in leaves of C₃ species**. *Planta* 1980, **149**:78-90.
70. Driever SM SA, Alotaibi S, Fisk SJ, Madgwick PJ, Sparks CA, Jones HD, , Lawson T PM, Raines CA: **Increased SBPase activity improves photosynthesis and grain yield in wheat grown in greenhouse conditions**. *Philos Trans R Soc Lond B Biol Sci*. 2017, **372**:1730.
71. Simkin AJ L-CP, Davey PA, Headland LR, Lawson T, Timm S, Bauwe, H RC: **Simultaneous stimulation of sedoheptulose 1,7-bisphosphatase, fructose 1,6-bisphosphate aldolase and the photorespiratory glycine decarboxylase-H protein increases CO₂ assimilation, vegetative biomass and seed yield in Arabidopsis**. *Plant Biotechnol J*. 2017, **15**:805-816.
72. Rosenthal DM LA, Khozaei M, Raines CA, Long SP, Ort DR. : **Over-expressing the C(3) photosynthesis cycle enzyme Sedoheptulose-1-7 Bisphosphatase improves photosynthetic carbon gain and yield under fully open air CO₂ fumigation (FACE)**. *BMC Plant Biol*. 2011, **11**.
73. Dumas L, Chazaux M, Peltier G, Johnson X, Alric J: **Cytochrome b 6 f function and localization, phosphorylation state of thylakoid membrane proteins and consequences on cyclic electron flow**. *Photosynth Res* 2016, **129**:307-320.
74. Simkin A, McAusland L, Lawson T, Raines CA: **Over-Expression Of The RieskeFeS Protein Increases Electron Transport Rates And Yield In Arabidopsis**. *bioRxiv* 2017.

75. Dumas L, Zito F, Blangy S, Auroy P, Johnson X, Peltier G, Alric J: **A stromal region of cytochrome b6f subunit IV is involved in the activation of the Stt7 kinase in Chlamydomonas.** *Proc Natl Acad Sci U S A* 2017, **114**:12063-12068.
76. Dang KV, Plet J, Tolleter D, Jokel M, Cuine S, Carrier P, Auroy P, Richaud P, Johnson X, Alric J, et al.: **Combined increases in mitochondrial cooperation and oxygen photoreduction compensate for deficiency in cyclic electron flow in Chlamydomonas reinhardtii.** *Plant Cell* 2014, **26**:3036-3050.
77. Chaux F, Peltier G, Johnson X: **A security network in PSI photoprotection: regulation of photosynthetic control, NPQ and O₂ photoreduction by cyclic electron flow.** *Front Plant Sci* 2015, **6**:875.
78. Kromdijk J, Głowacka K, Leonelli L, Gabilly ST, Iwai M, Niyogi KK, Long SP: **Improving photosynthesis and crop productivity by accelerating recovery from photoprotection.** *Science* 2016, **354**:857.
79. Johnson X, Alric J: **Central carbon metabolism and electron transport in Chlamydomonas reinhardtii: metabolic constraints for carbon partitioning between oil and starch.** *Eukaryot Cell* 2013, **12**:776-793.
80. Iwai M, Takizawa K, Tokutsu R, Okamuro A, Takahashi Y, Minagawa J: **Isolation of the elusive supercomplex that drives cyclic electron flow in photosynthesis.** *Nature* 2010, **464**:1210.
81. Krueger S, Giavalisco P, Krall L, Steinhauser MC, Bussis D, Usadel B, Flugge UI, Fernie AR, Willmitzer L, Steinhauser D: **A topological map of the compartmentalized Arabidopsis thaliana leaf metabolome.** *PLoS One* 2011, **6**:e17806.
82. Balcke GU, Bennewitz S, Bergau N, Athmer B, Henning A, Majovsky P, Jiménez-Gómez JM, Hoehenwarter W, Tissier A: **Multi-Omics of Tomato Glandular Trichomes Reveals Distinct Features of Central Carbon Metabolism Supporting High Productivity of Specialized Metabolites.** *The Plant Cell* 2017, **29**:960.