



HAL
open science

LIBS applications and industrial aspects

D. L'Hermite

► **To cite this version:**

D. L'Hermite. LIBS applications and industrial aspects. Otpoandina 2015 - International Year of Light and Light-Based Technologies, Nov 2015, Quito, Ecuador. hal-02445708

HAL Id: hal-02445708

<https://cea.hal.science/hal-02445708>

Submitted on 20 Jan 2020

HAL is a multi-disciplinary open access archive for the deposit and dissemination of scientific research documents, whether they are published or not. The documents may come from teaching and research institutions in France or abroad, or from public or private research centers.

L'archive ouverte pluridisciplinaire **HAL**, est destinée au dépôt et à la diffusion de documents scientifiques de niveau recherche, publiés ou non, émanant des établissements d'enseignement et de recherche français ou étrangers, des laboratoires publics ou privés.

LIBS APPLICATIONS AND INDUSTRIAL ASPECTS

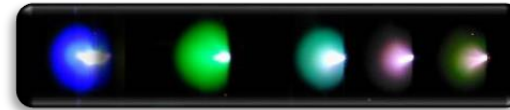

Daniel L'HERMITE

CEA / DEN / DPC / SEARS / LANIE

CEA Saclay

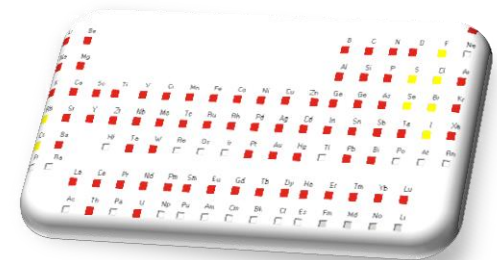
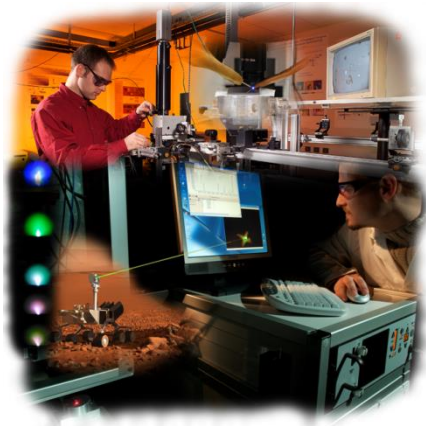

20ª ESCUELA
OPTOANDINA
QUITO-2015

OPTOANDINA 2015, 9-13 Nov. Quito, Ecuador

LIBS PRINCIPLE

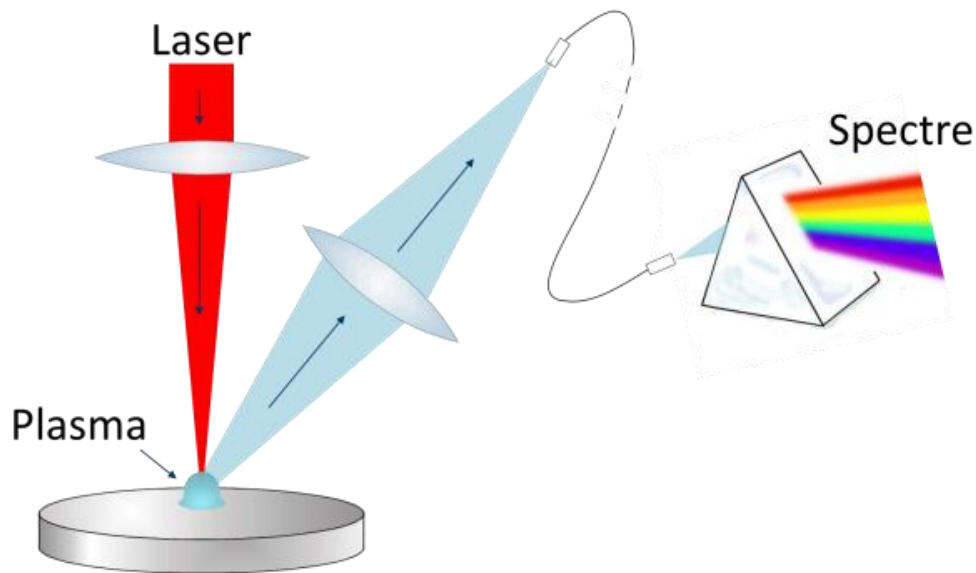

☐ Measurement on all kind of materials



☐ No sample preparation



R.Bruder CEA and LRMH

☐ Real-time measurement (1sec to a few min)

☐ Multi-elementary measurement

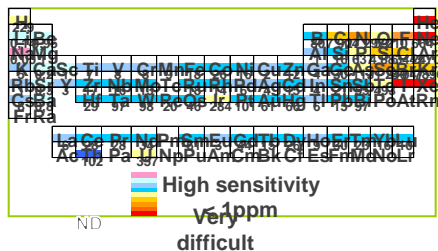

☐ Remote measurement

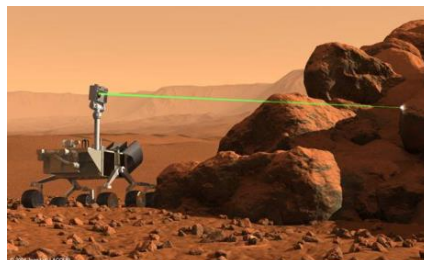

Like "Curiosity"
Landing on Mars
on August 2012

LIBS is well adapted for in-situ and field analysis

Industrialization means :

- ❑ Robustness → No change in the measurement during time and limited changes vs external conditions (temperature, humidity, chocs, dust,...)**

- ❑ System control → Repeatability, reproducibility, and quickly**

- ❑ Data treatment → For non expert users**

Spectrometer

Monocromador

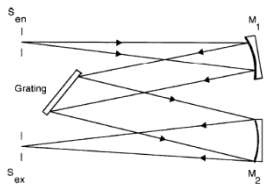

Moving part (grid)

Policromador

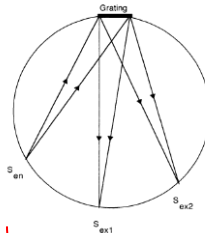

Echelle

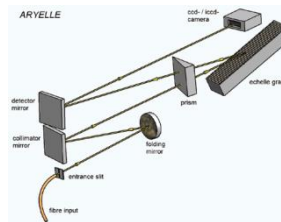

No moving part

Compacto



All are sensitive to the temperature → thermalization

Laser (Nd:YAG in general)

Pump by

- Flash lamp → not expensive but energy decrease and the lifetime is not too long (1 month 24/24)
- Laser diode → Expensive but stable and long lifetime

λ

- 1064nm : no harmonic crystal
- 532nm : 1 crystal
- 355 and 266nm : 2 crystals

Pb of stability with temperature and mechanically

What kind of “options” does a industrial LIBS system should have?

- *Lens/sample distance control → mechanical or optical (+ z adjustment)*

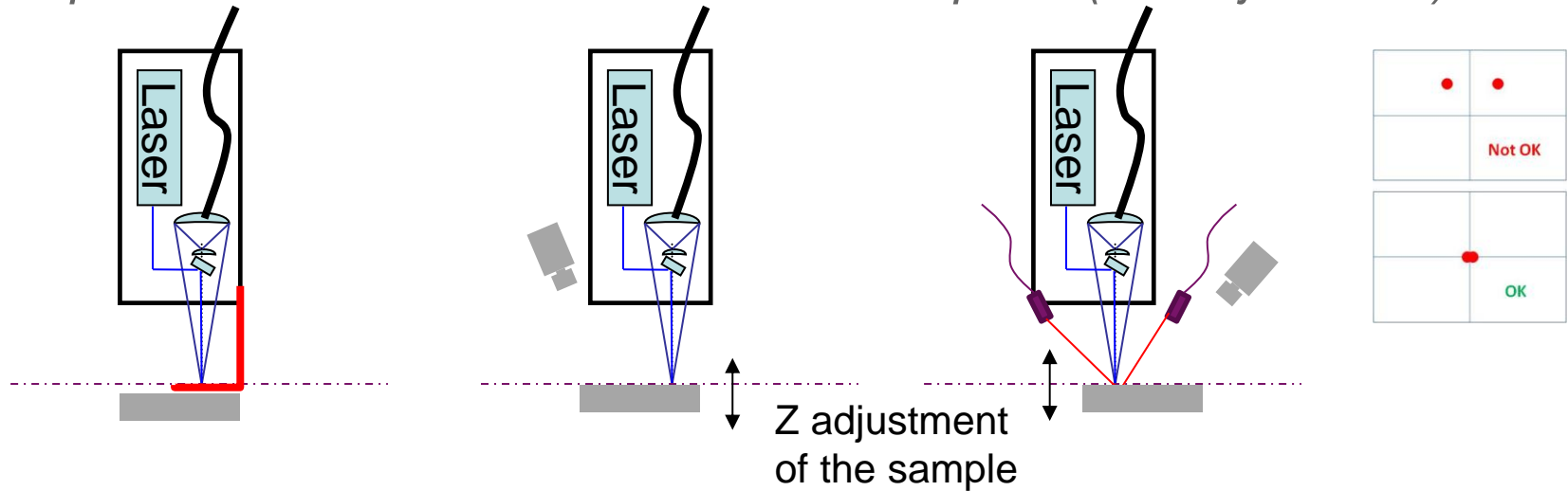

- *Duplicate measurements for statistical purpose (typically > 20) → x,y motors*

Goal : to acculate many laser shots (best S/N ratio), to have a good estimation of the mean signal $\langle S \rangle$ and to have an idea of the repeatability with the standard deviation σ_s

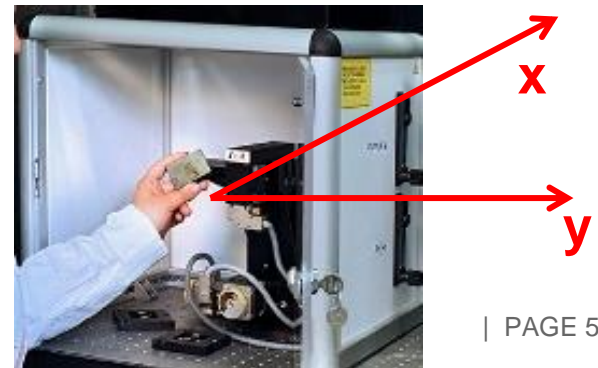

□ E_{laser} measurement (for normalization) : in order to perform quantitative analysis

□ E_{laser} adjustment → optical attenuator

□ Shutter to have a stable laser

□ Contactor for laser safety

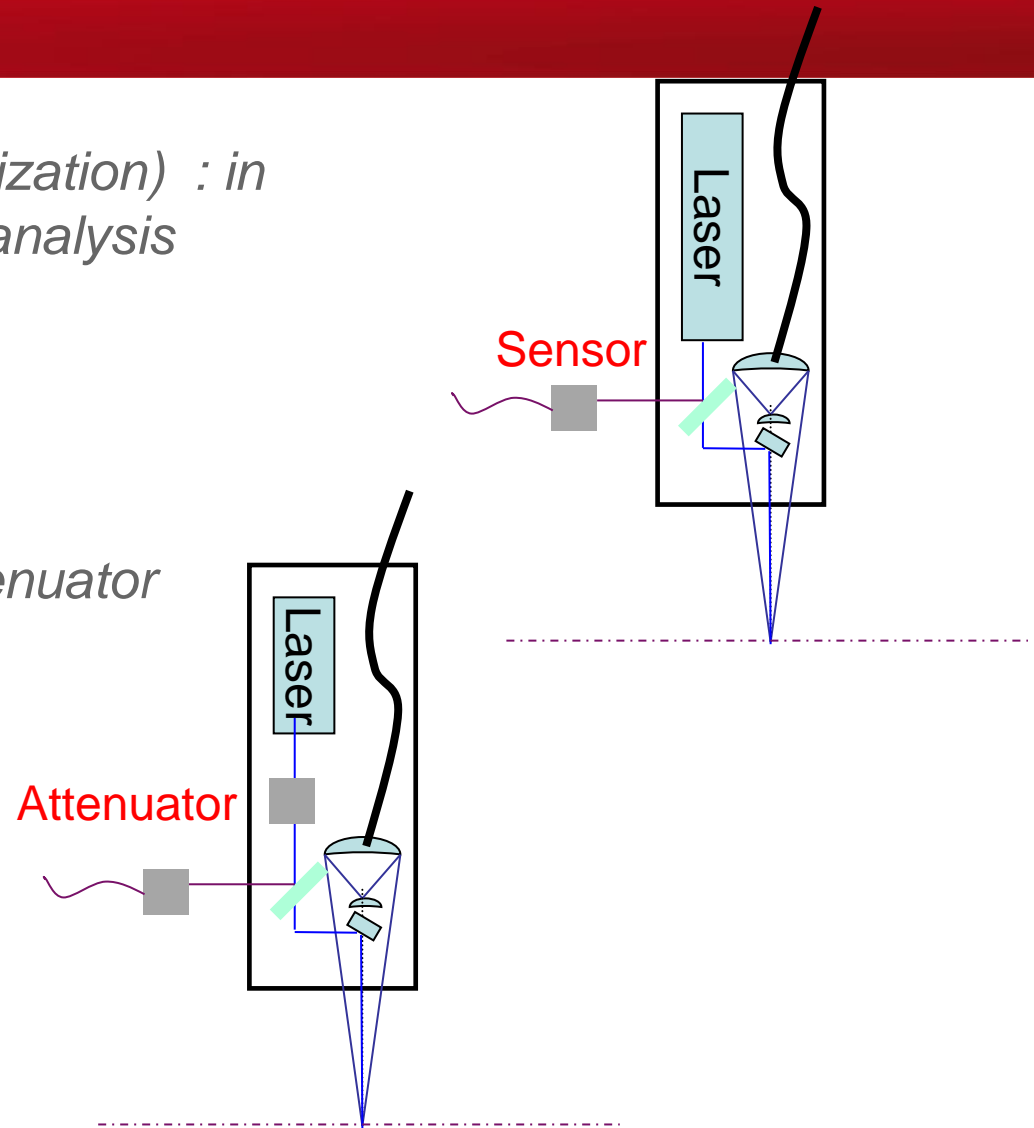

SYSTEM CONTROL = DEVICES CONTROL

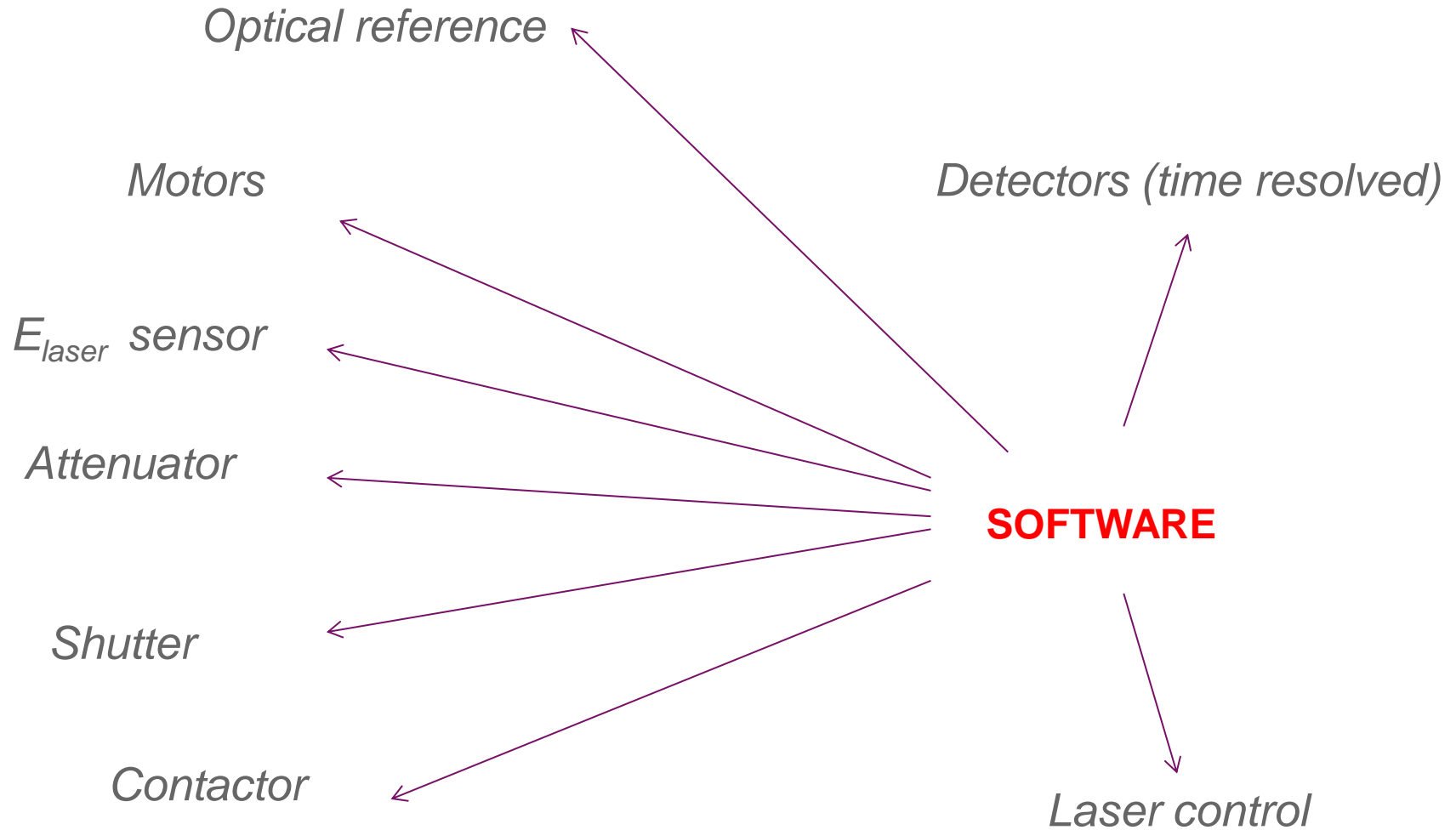

→ Could be complex (pb of timing, synchronization)

DATA TREATMENT

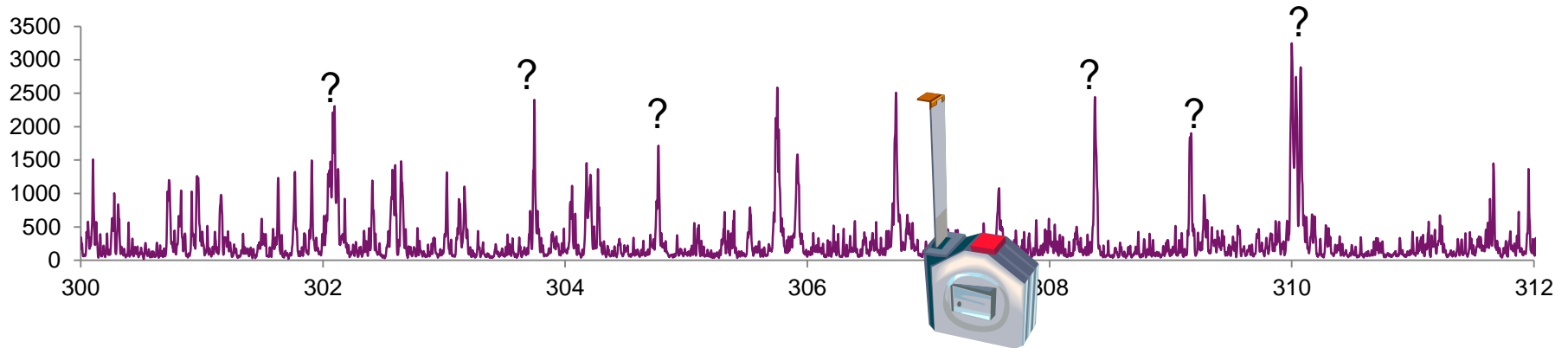

A user who buy a LIBS system is not a specialist of LIBS



→ The manufacturer may adapt its LIBS software to the final needs

→ The result must be friendly to use

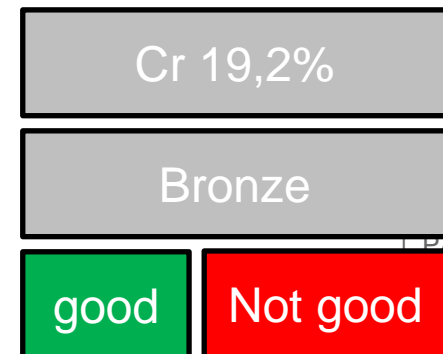

To have a succesfull data traitement,
I suggest this association

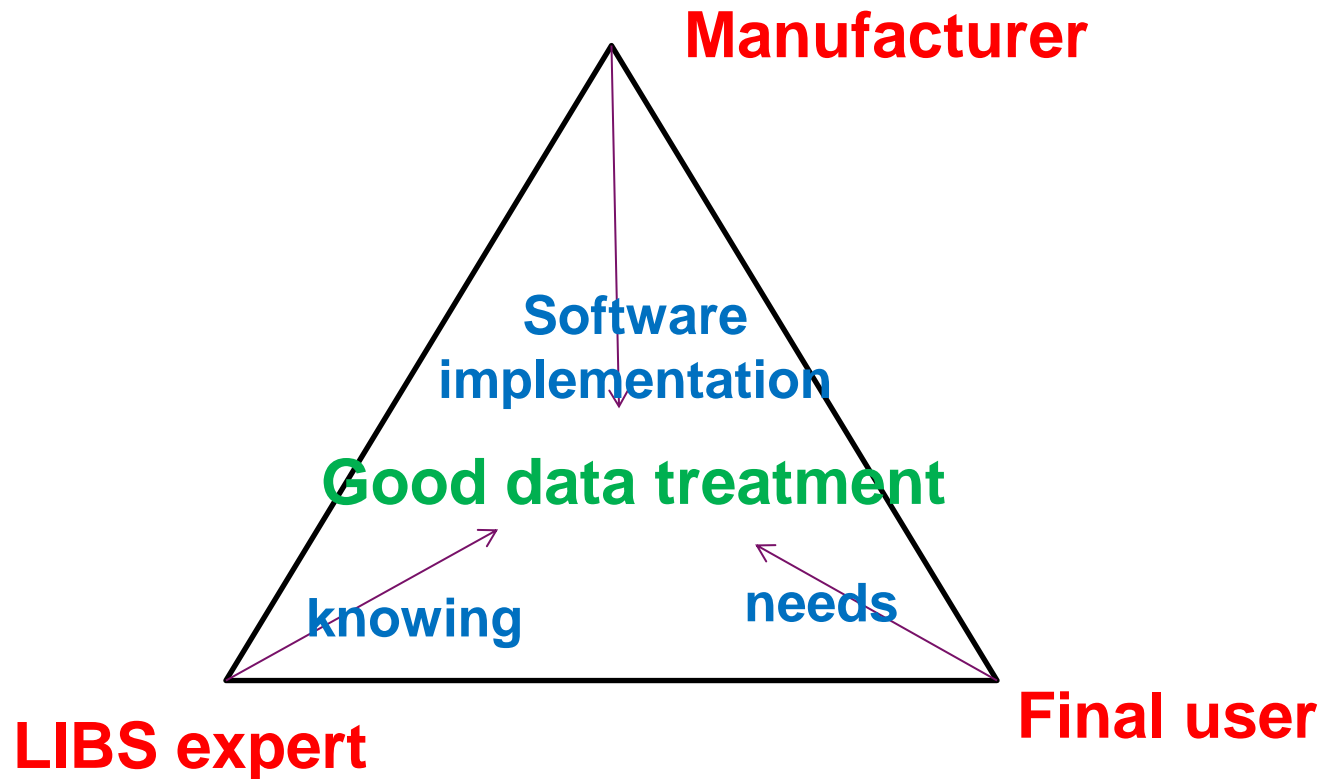

TO RESUME

The manufacturer have many things to implement and to manage (devices) and

Data treatment have to be adapted for each “user”

- ▶ **Cost ↗ and the market are actually not so big (niche market)**
- ▶ **Actually the volume of the market are not enough to obtain a decrease of the prices (laser and spectrometer).**

Hard work but actually many manufacturers propose different LIBS systems

Examples of industrial systems

STAND-OFF CONFIGURATION

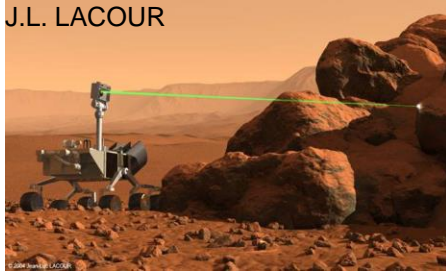
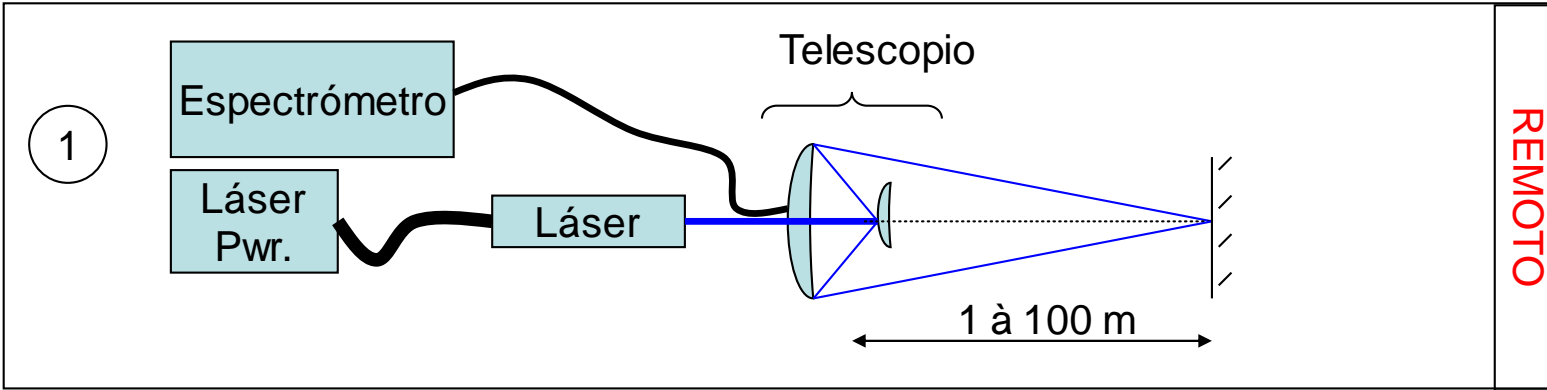

*Chemcam,
NASA(usa), CNES (fr)*



FARLIBS, IVEA (fr)



Applied photonics (uk)



TeleLIBS, LSA (de)

BENCH TOP CONFIGURATION

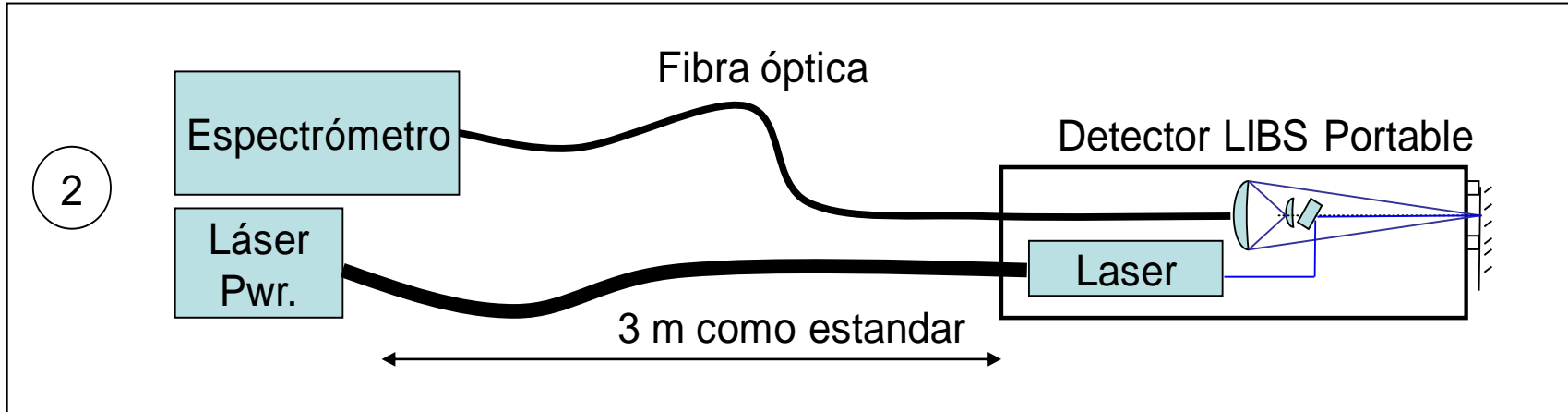

MOBILIBS, IVEA (fr)



LIBSLab, LTB (de)



Applied spectra (usa)

Avantes (nl)

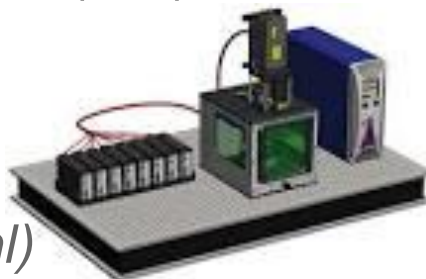

LIBSscan, Applied photonics (de)



REMOTE (FIBER) CONFIGURATION

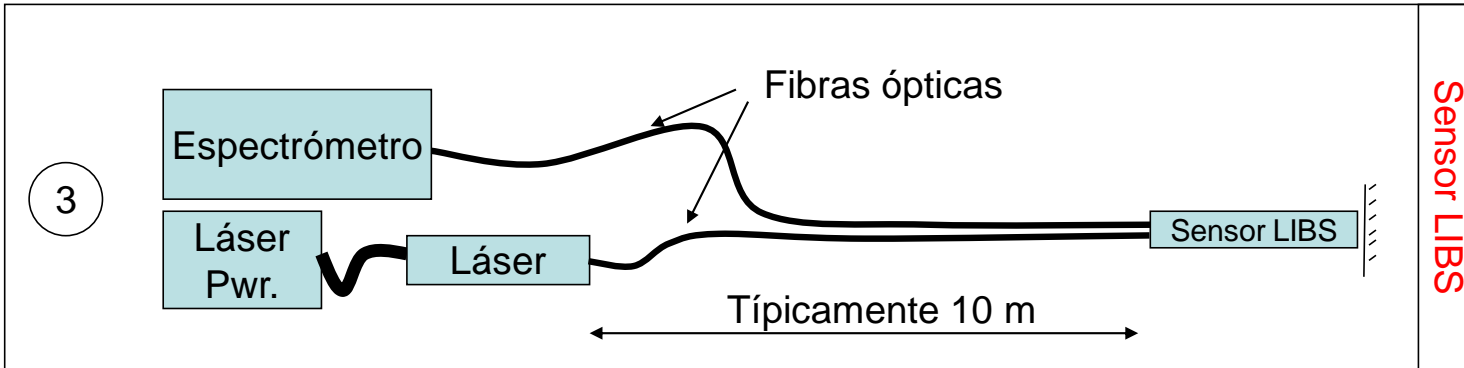

OFILIBS, IVEA (fr)

Applied photonics (uk)

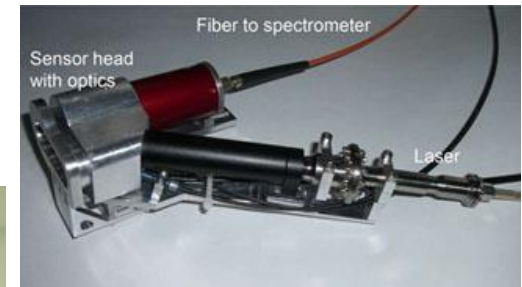

DLR, (de)

HANDABLE CONFIGURATION

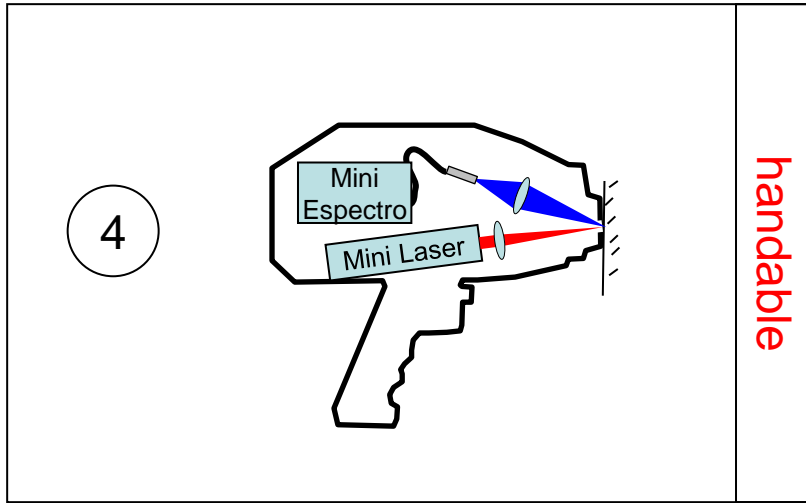

EASYLIBS
IVEA (fr)



Katana
Rigaku (jp)



Eos
Brucker (uk)



LIBS solution
B&W Tek (usa)



mPulse
Oxford (usa)



Chemlite
TSI (usa)



LIBZ
Sciaps (usa)

5

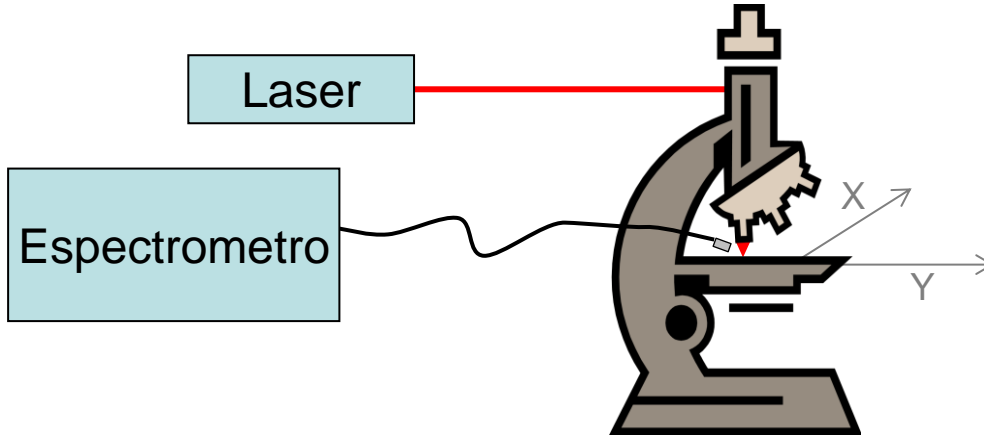

Micro-LIBS

MEEP
IVEA (fr)

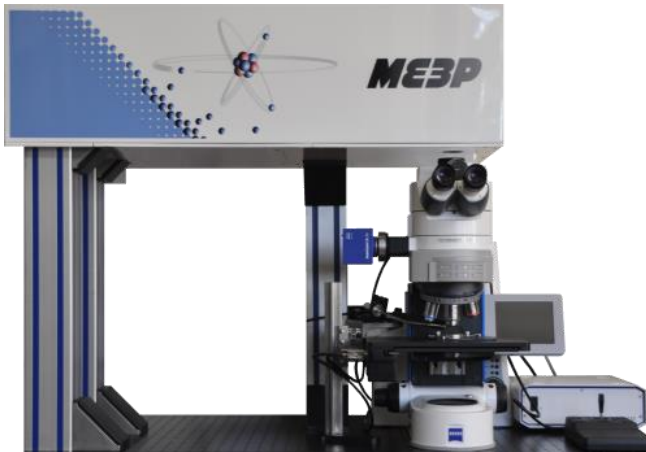

Main domains of applications:

Industrial process monitoring

Measurement in hostile environment (nuclear, spatial...)

Recycling

Environmental analysis

Artwork

Biological Applications

Micro structure analysis

Security (Forensic, NRBC)

Pharmaceutics and food control

Geological, mine prospection

And many others

VERIFICATION OF THE SYSTEM

It is important to verify that the system is operational for measurement → we may use a reference sample

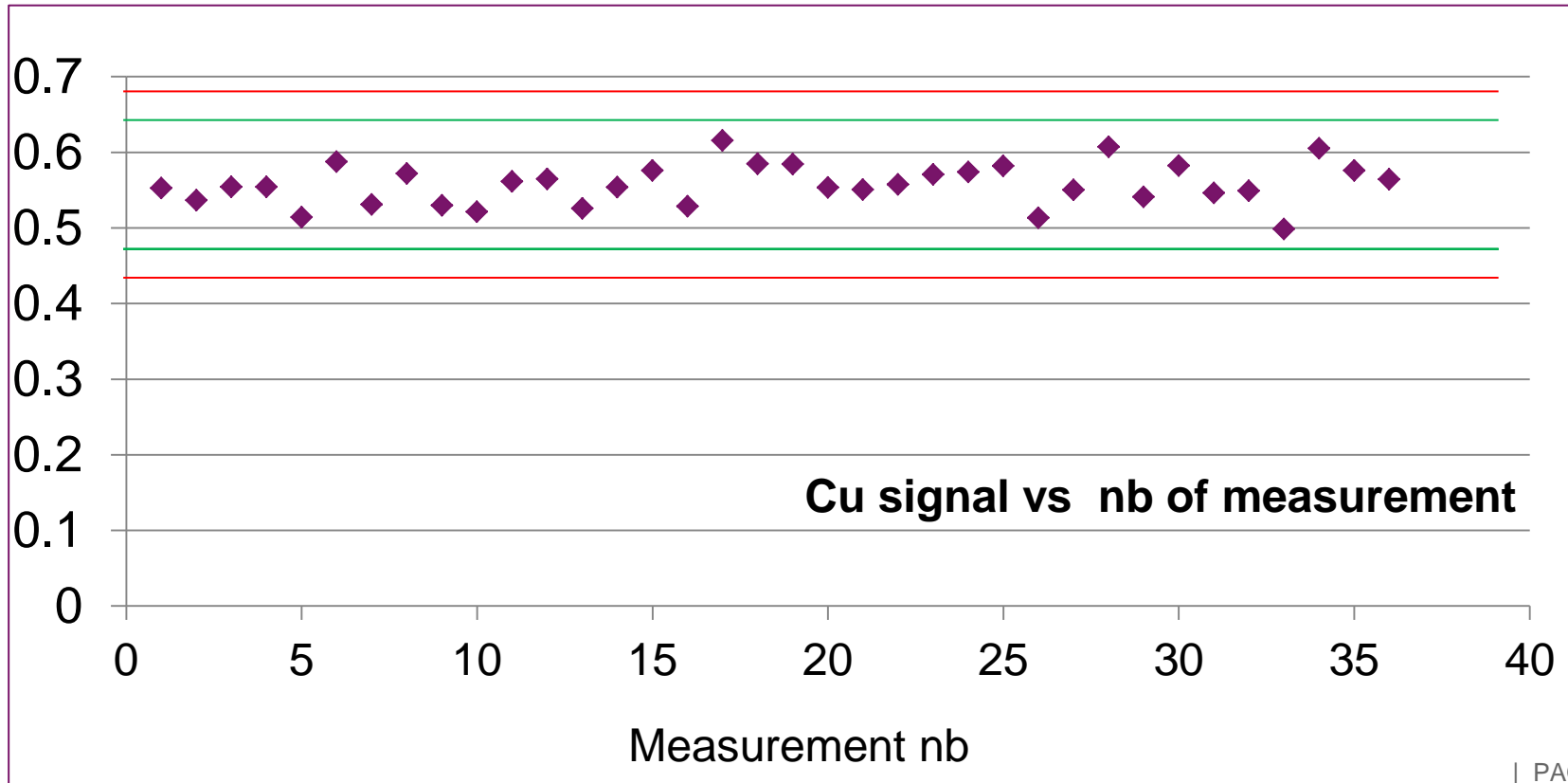

EXAMPLE 1: MEASUREMENT ON LIQUID

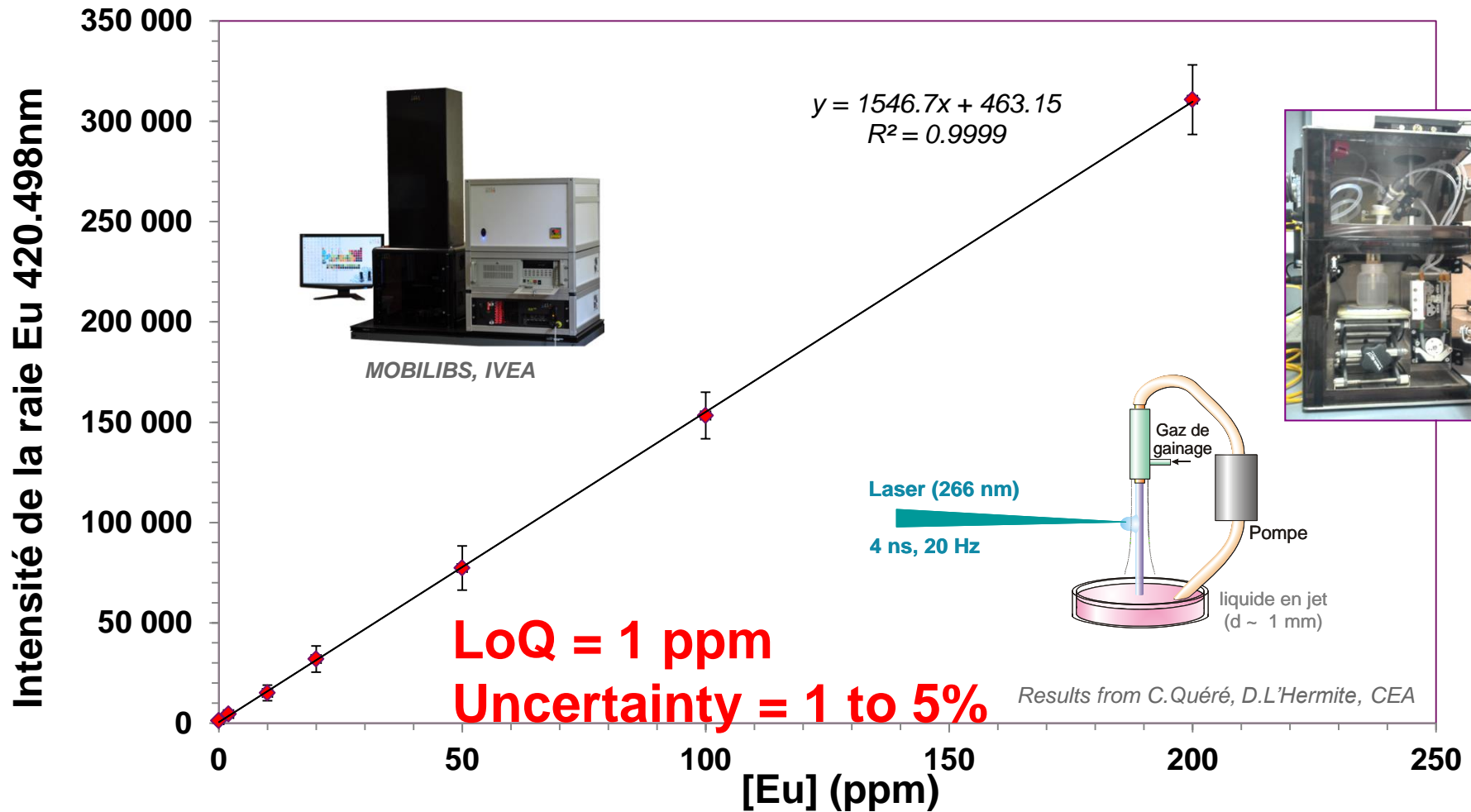

- The good linearity is not due to chance and is not an arrangement of data
- An ideal sample and an equipment with good repeatability

EXAMPLE 2 : VITRIFICATION OF NUCLEAR WASTE

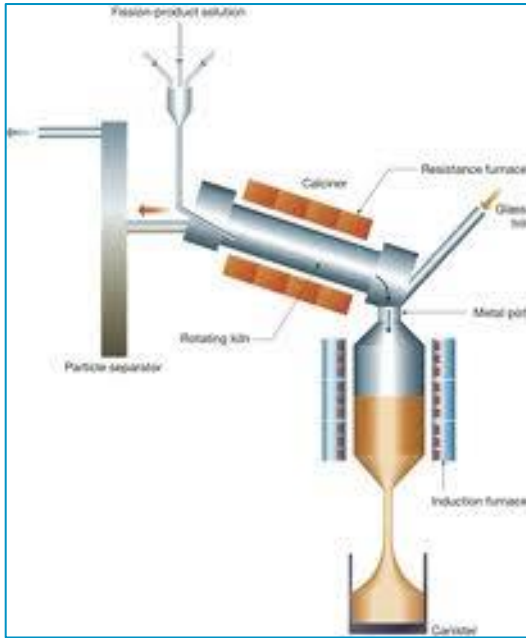

Goal : trap the nuclear waste in glass (chemically very stable) for long time

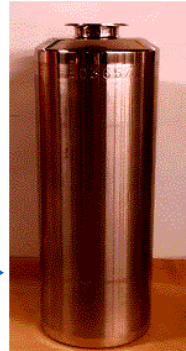
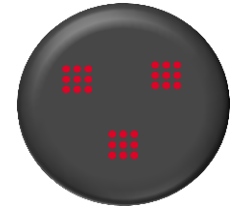
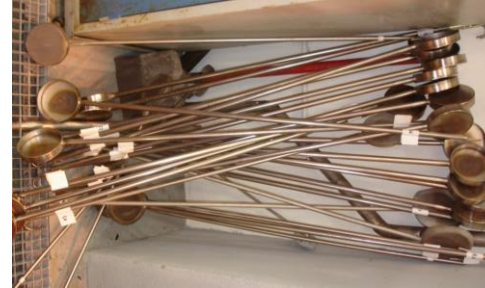

MOBILIBS, IVEA (fr)

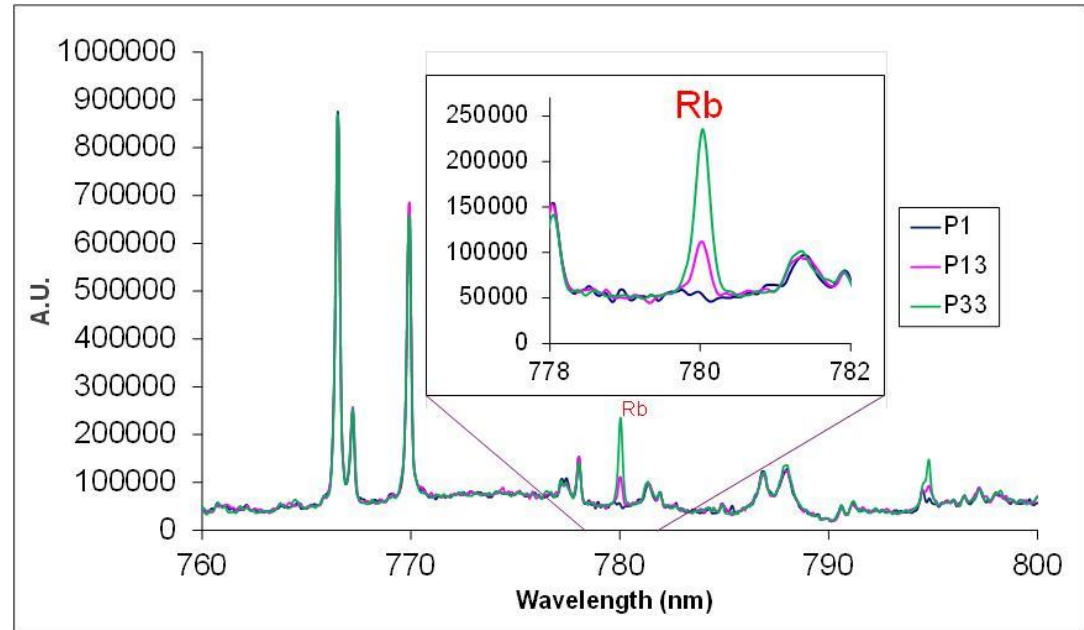

Results from E. Sauvage, C. Roche CEA

Comparison LIBS vs ICP/MS

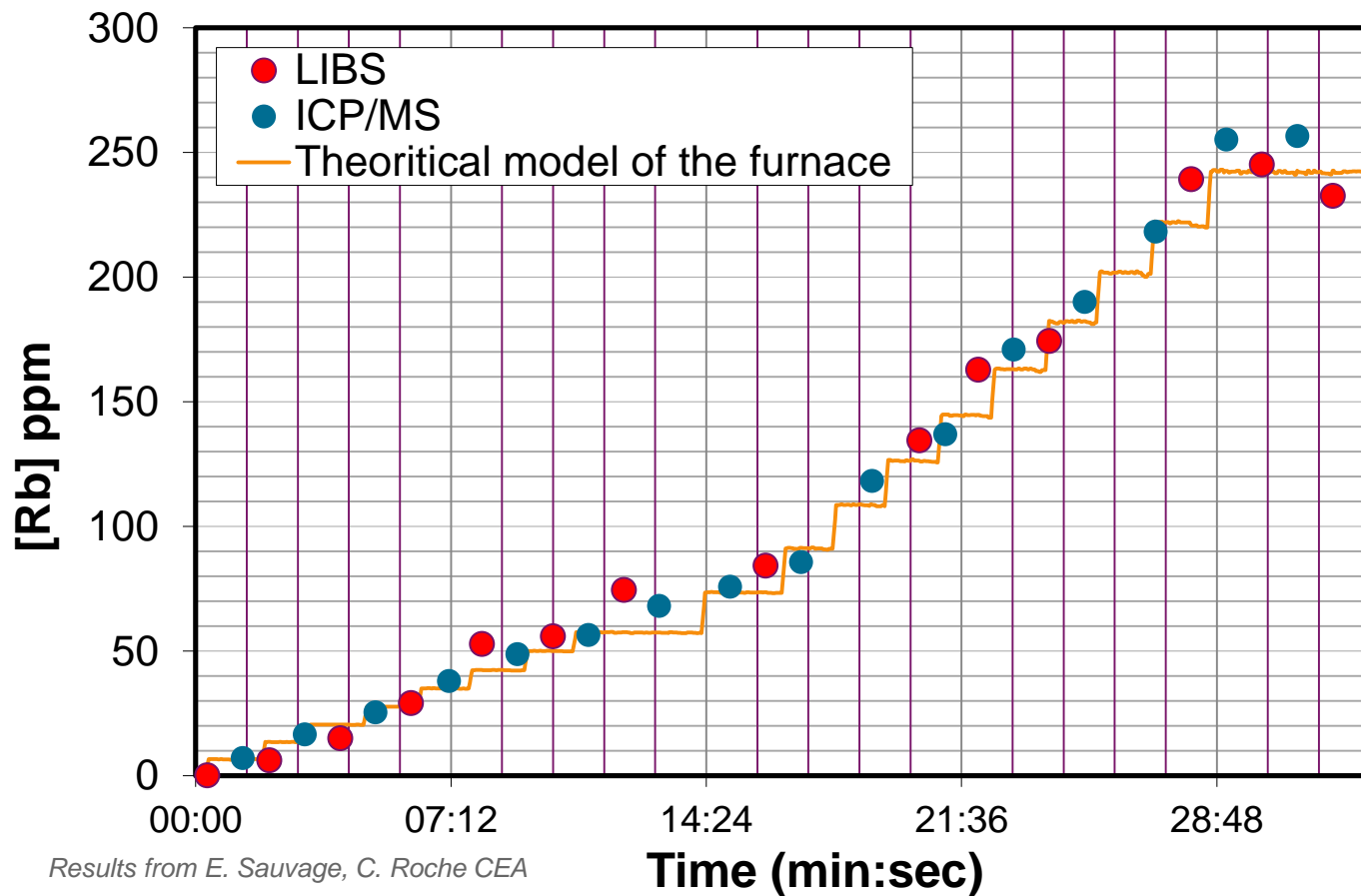

▶ Good agreement between ICP-MS and LIBS (<8%)



▶ Time of analysis : LIBS : few hours



ICP-MS : 6 months

Mo quantification in the glass

Without normalization

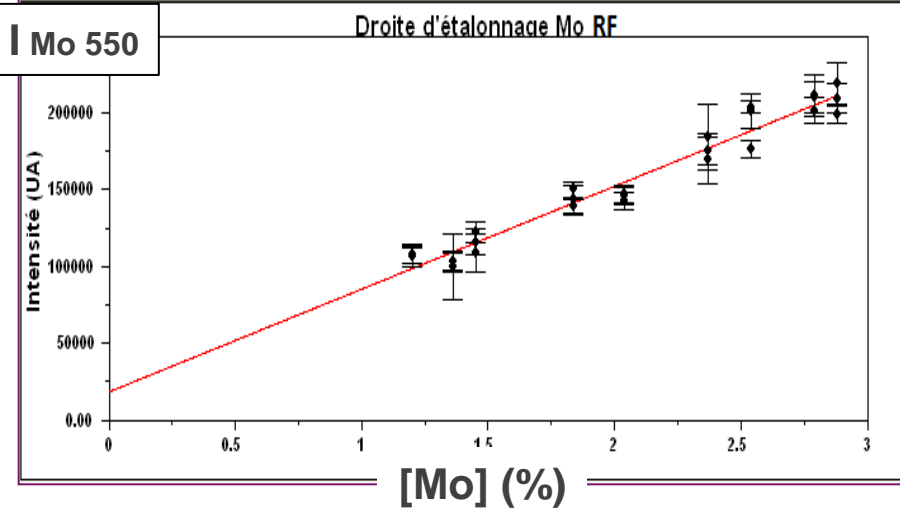

With normalization by Na line

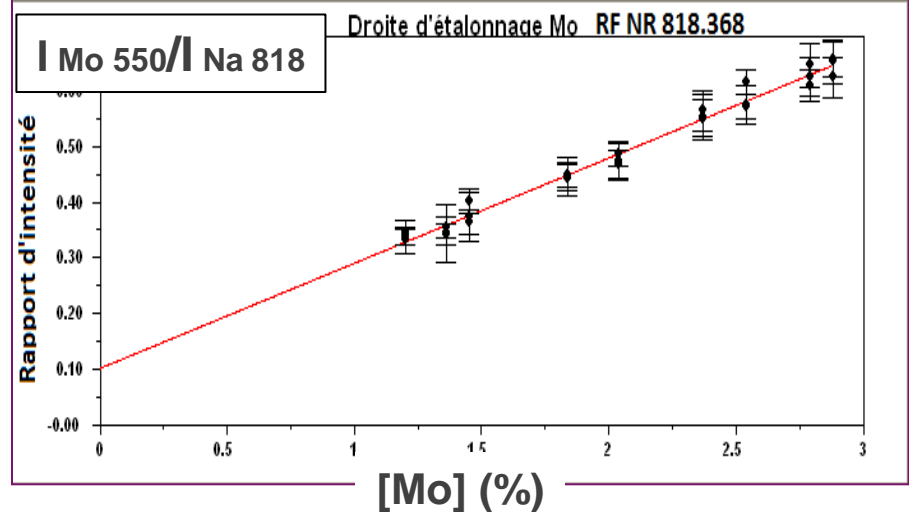

SAMPLE	FX values (Reference)		Without normalisation		With normalisation	
	MoO3 (%)	Na2O (%)	MoO3 (%)	deviation (%)	MoO3 (%)	deviation (%)
C3	2,88	9,54	2,75	4,51	2,67	6,96
C4	2,79	9,54	2,77	0,72	2,76	1,08
C6	1,84	9,67	1,75	4,89	1,77	3,80
C8	1,45	9,83	1,61	11,03	1,50	3,45

With normalization: deviation <7% between LIBS and XRF

(Usual technique for glass analysis)

EXAMPLE 3 : DETECTION OF CHEMICAL WARFARE AGENT (CWA)

$C_4H_{10}O_2PF$ $C_7H_{16}O_2PF$	Sarin GB Soman GD
$C_5H_{11}O_2N_2P$	Tabun GA
$C_{11}H_{26}O_2NPS$	VX
$C_4H_8Cl_2S$, $S=(C_2H_4Cl)_2$	HD, H
$C_2H_2AsCl)_3$	L

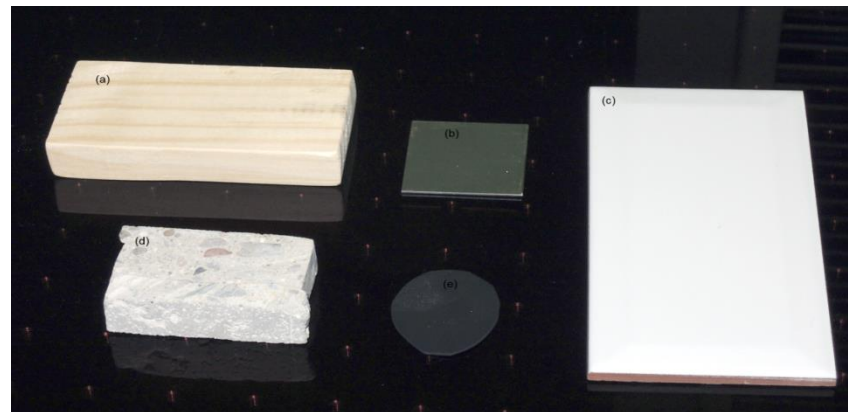

EASYLIBS, IVEA (fr)



Development of a specific data treatment



EXAMPLE 3 : DETECTION OF CHEMICAL WARFARE AGENT (CWA)

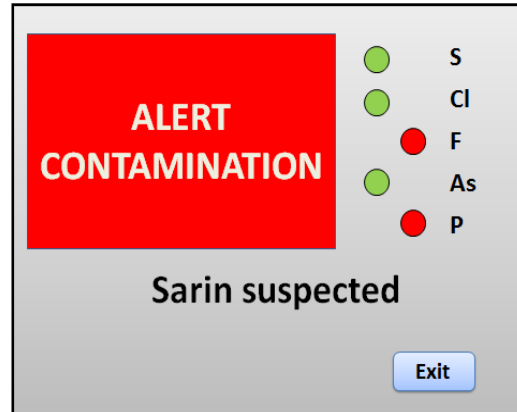
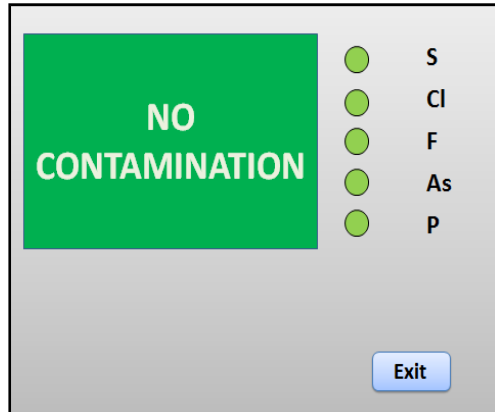

One shot per measurement



Instantaneous response

Rate of good result	HD	L1	VX	GB	Blank
CARC paint	4 / 5	5 / 5	0 / 5	5 / 5	0/5
concrete	3 / 5	5 / 5	0 / 5	4 / 5	0/5
wood	5 / 5	5 / 5	3 / 5	4 / 5	0/5

- ▶ Results are globally ok but not for VX on CARC and concrete
- ▶ This is due to the high viscosity and low vapor pressure of VX → too amount of liquid → difficult to make a plasma with handable LIBS system

EXAMPLE 4 : CHEMCAM (CURIOSITY) ON MARS

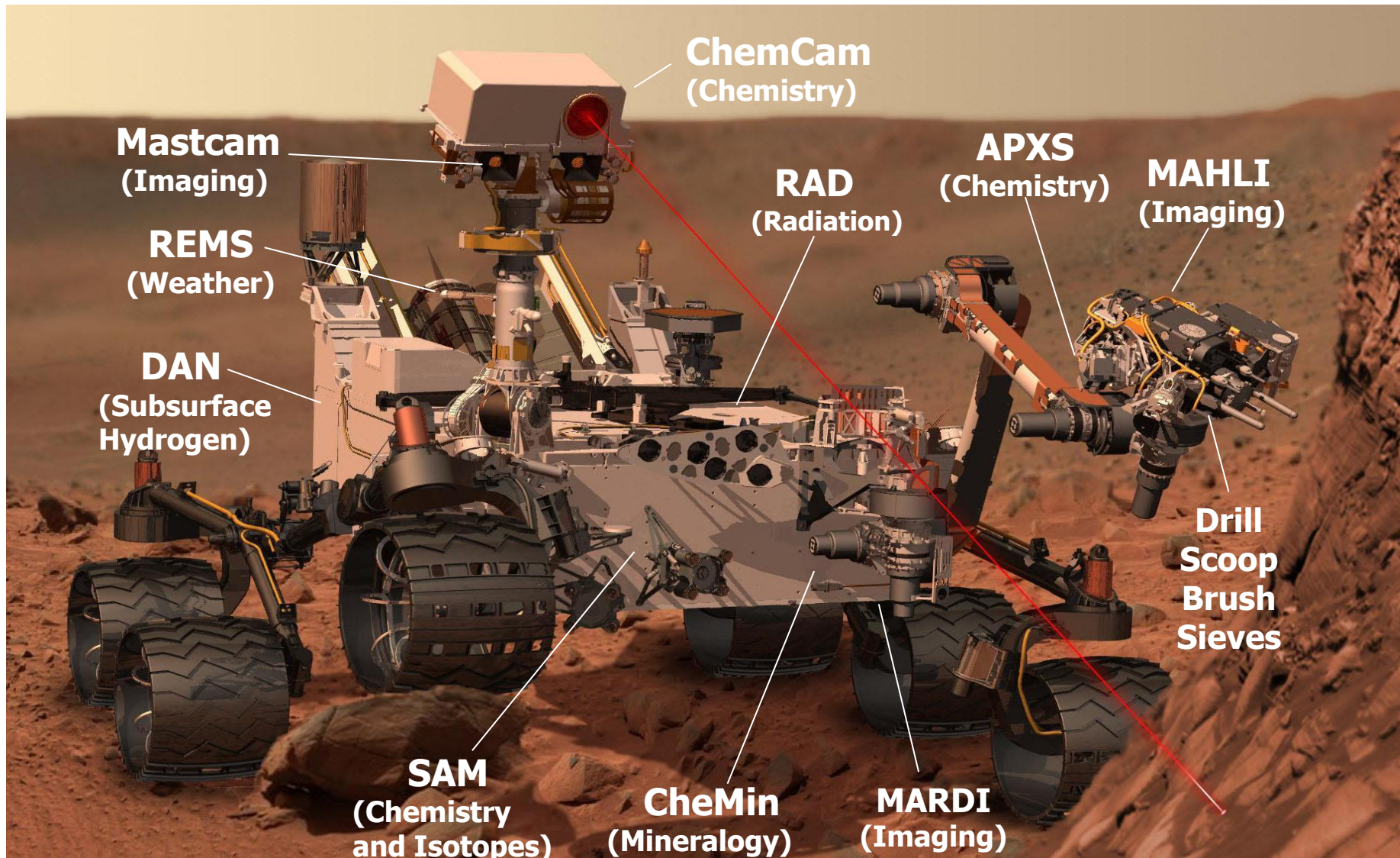

EXAMPLE 4 : CHEMCAM (CURIOSITY) ON MARS

- Feasibility to do LIBS on Mars was carried out in our laboratory (2002) (CEA Saclay, France)



CEA Saclay; DPC/SEARS/hall 15

EXAMPLE 4 : CHEMCAM (CURIOSITY) ON MARS



Image credit NASA/JPL

❑ Works since august 2012 (more than 3 years without problem)

❑ Displacement :
7 km

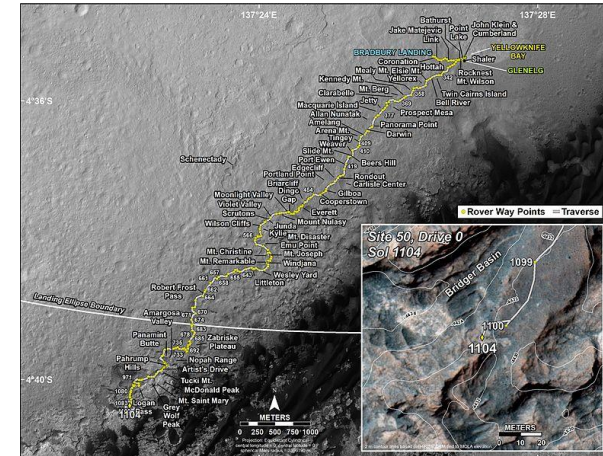
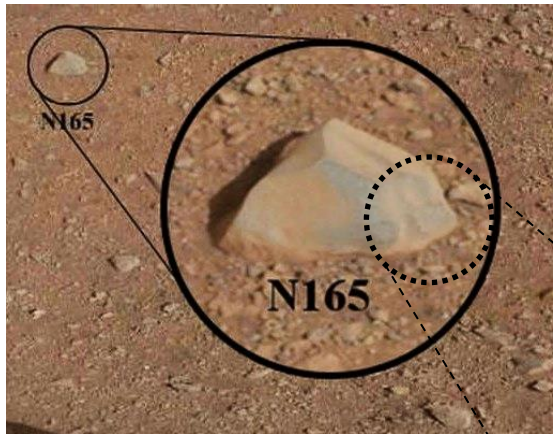

Image credit NASA/JPL

❑ Chemcam is the instrument which works the more (~ every day)

- ❑ $\lambda=1067$ nm
- ❑ Train of pulses (50) (remove dust)
- ❑ 15mJ /pulse
- ❑ Working distance (1,5 to 7m)

LIBS works well on Mars and helps geologist



**Frist rock analysed by ChemCam on Mars
: Coronation**

It wasn't a interesting rock but just to the system

Crédit images : NASA/JPL-
Caltech/MSSS/LANL/CNES/IRAP

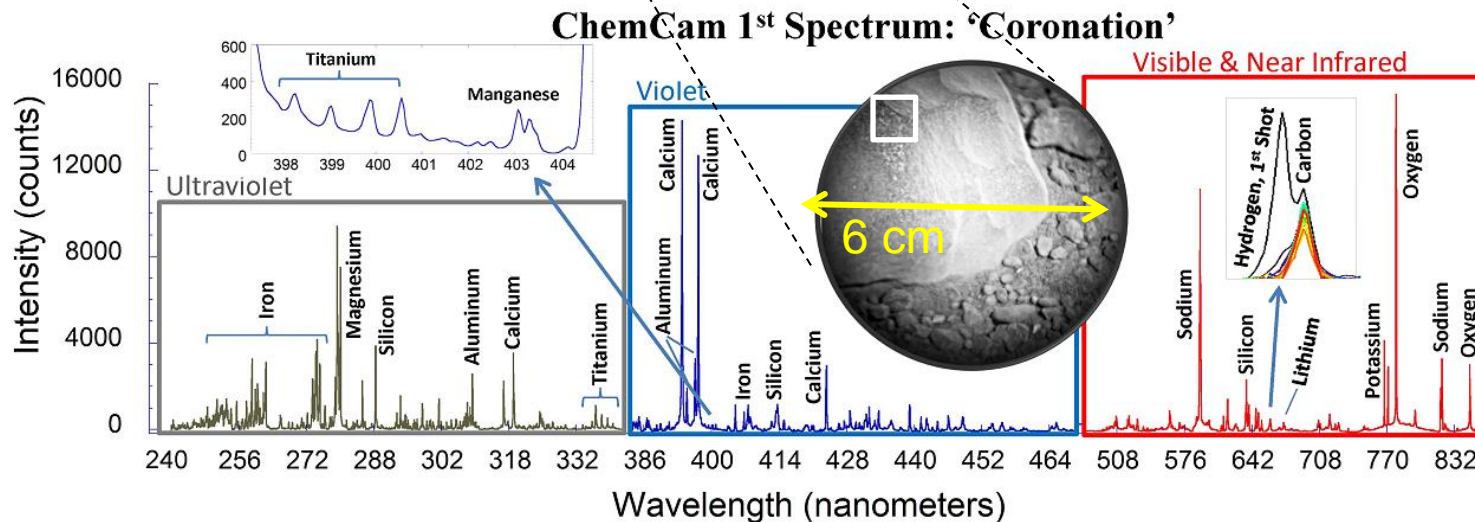

□ Hydrated soil and dust

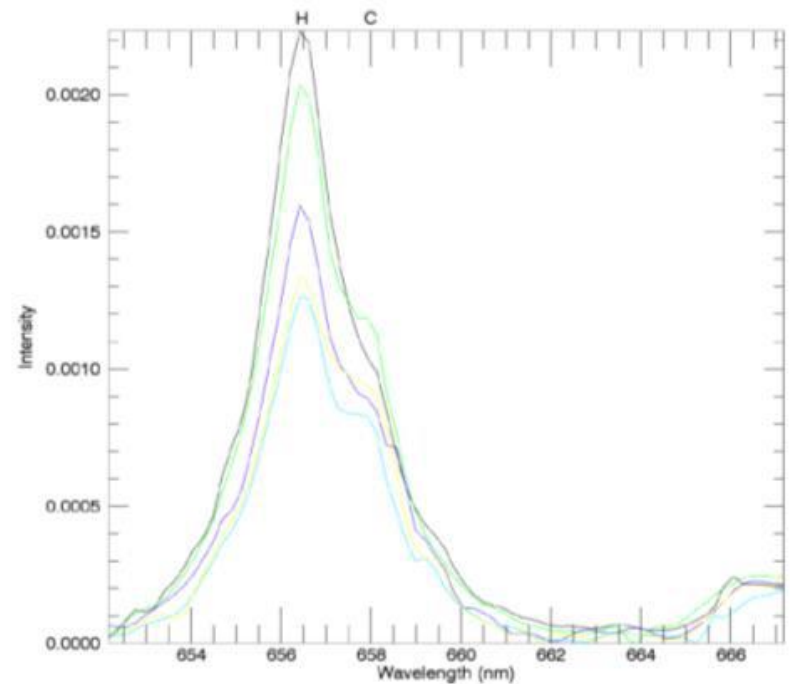
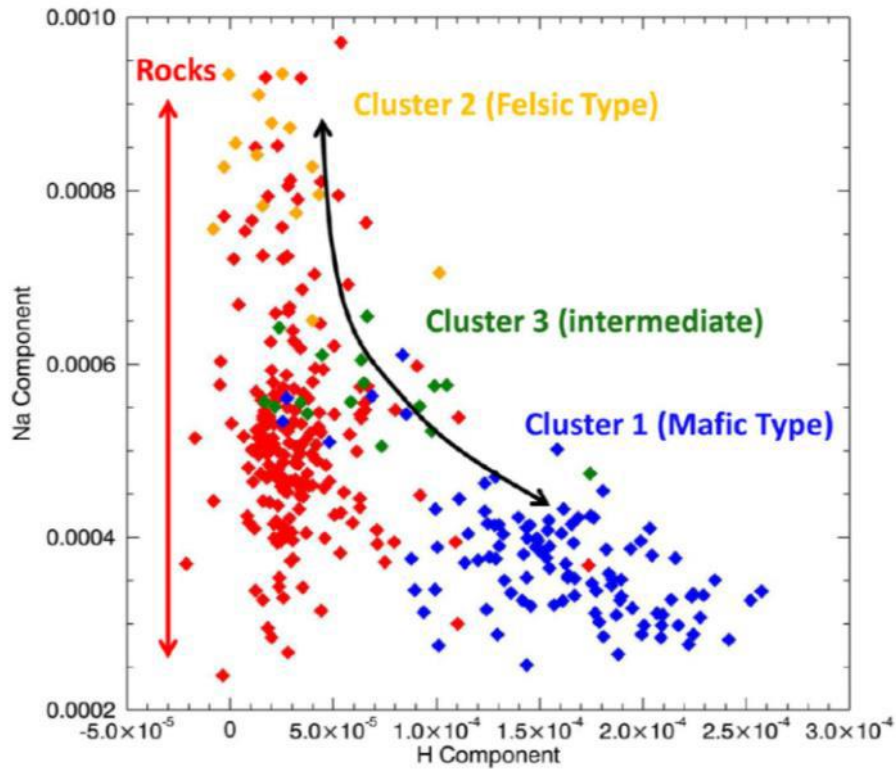

http://pds-geosciences.wustl.edu/workshops/ChemCam_Workshop_Mar14.htm

□ First Mars fluorine chemistry

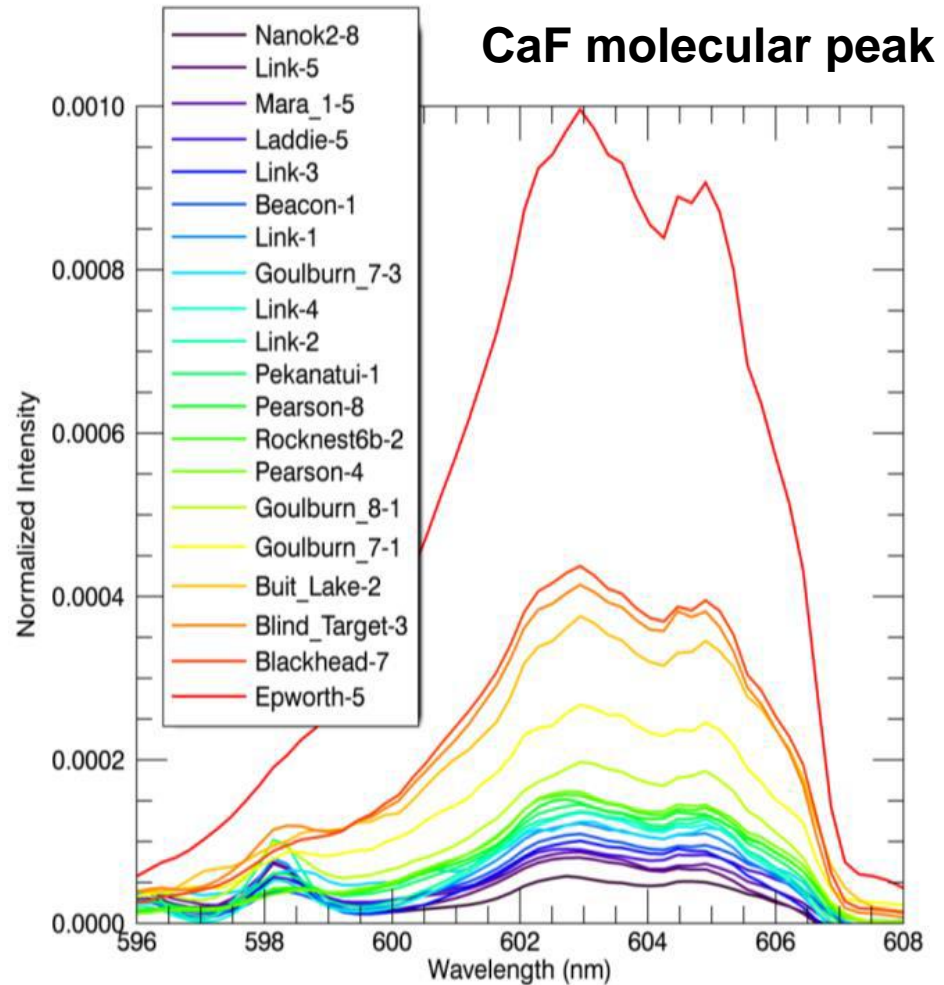

□ First manganese-rich minerals

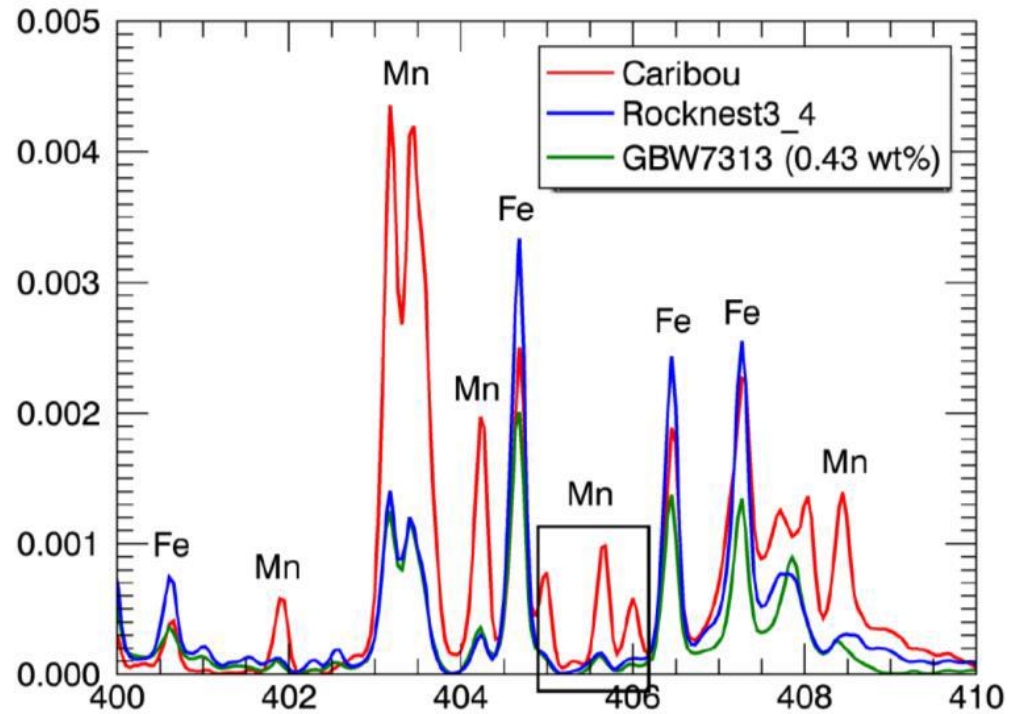

□ First Li, Rb, Sr, and Ba on Mars

- These elements have generally never been seen on Mars before and they each have implications for Mars geochemistry.
- Lithium is a strong indicator of alteration;
- Rb, Sr, and Ba each tend to be sequestered in different minerals:
- Rb in anorthoclase,
- Sr in albite and more so in anorthite, etc.
- The global Rb/K ratio has important implications for planetary origins.

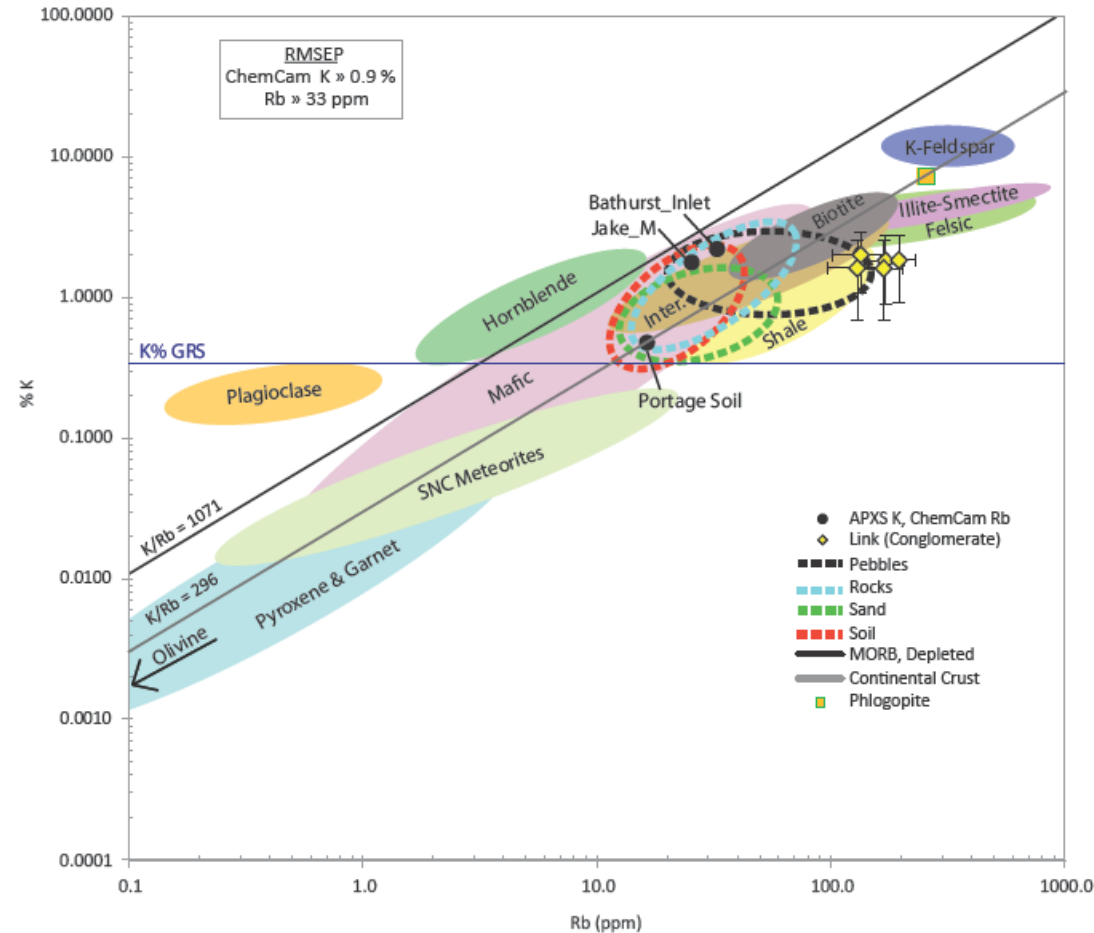

□ Rock surface alteration of mobile elements

The gradient was consistent among all observed elements, definitively showing relatively recent rock surface alteration

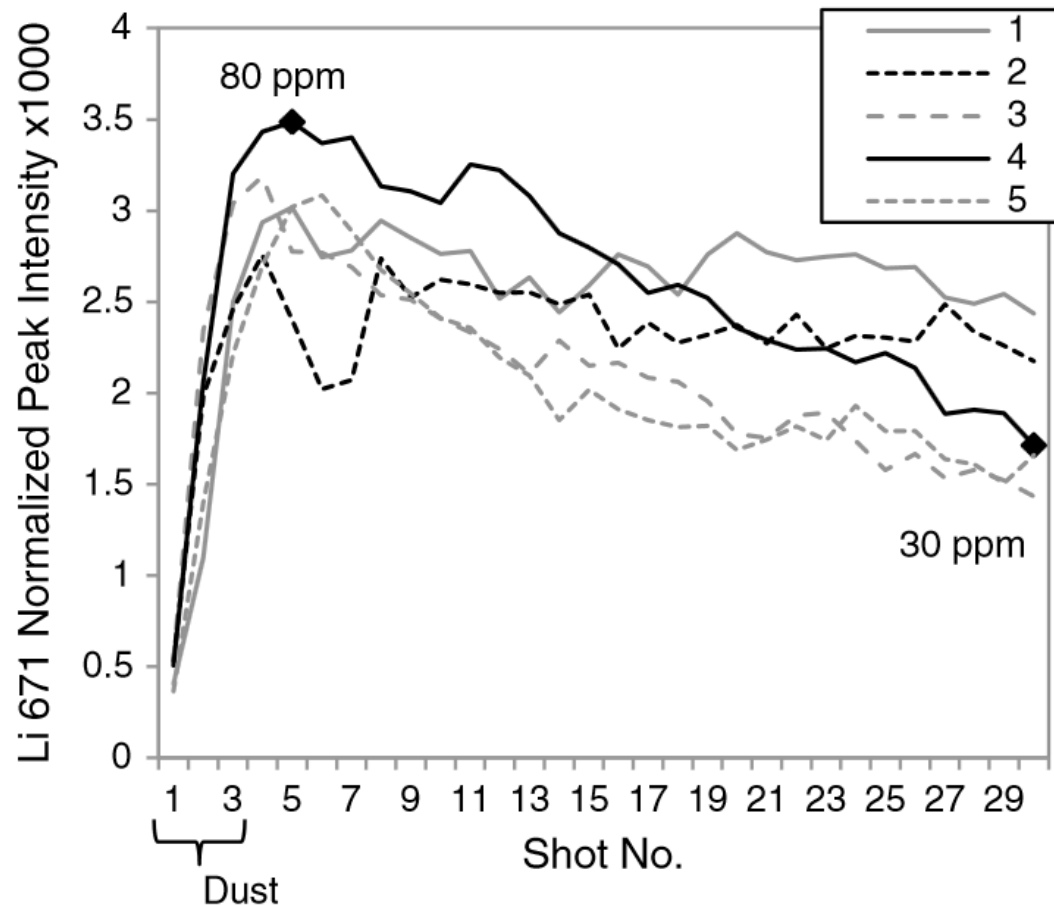

□ Fe-rich cements in sediments

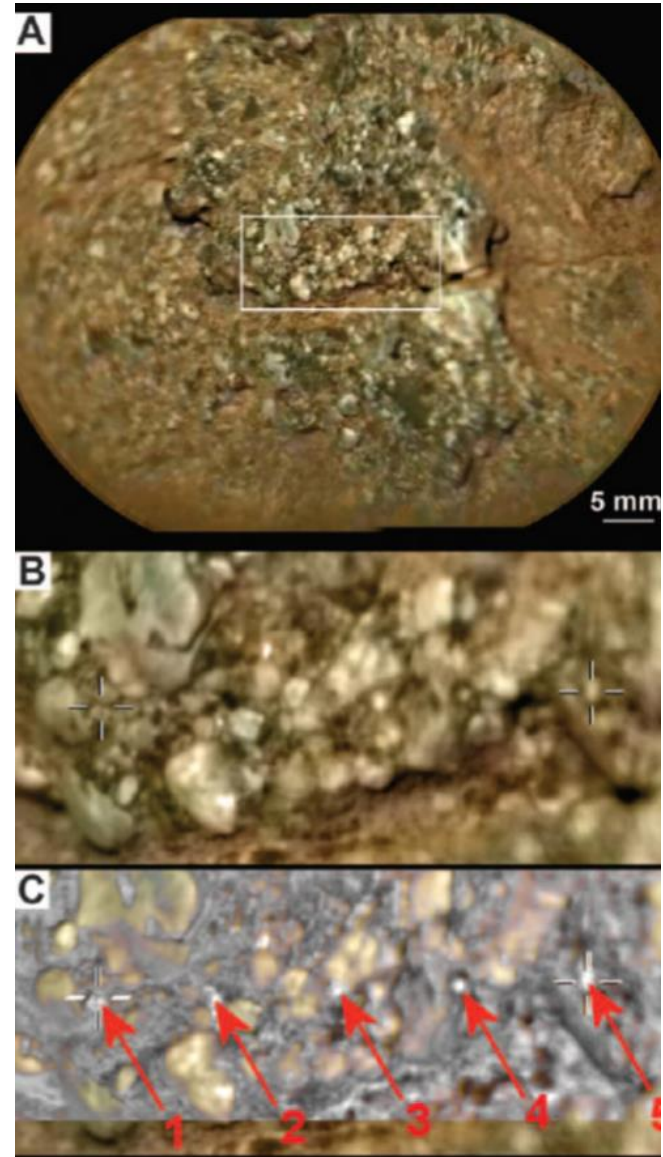

□ Ca-sulfate veins, variable hydration

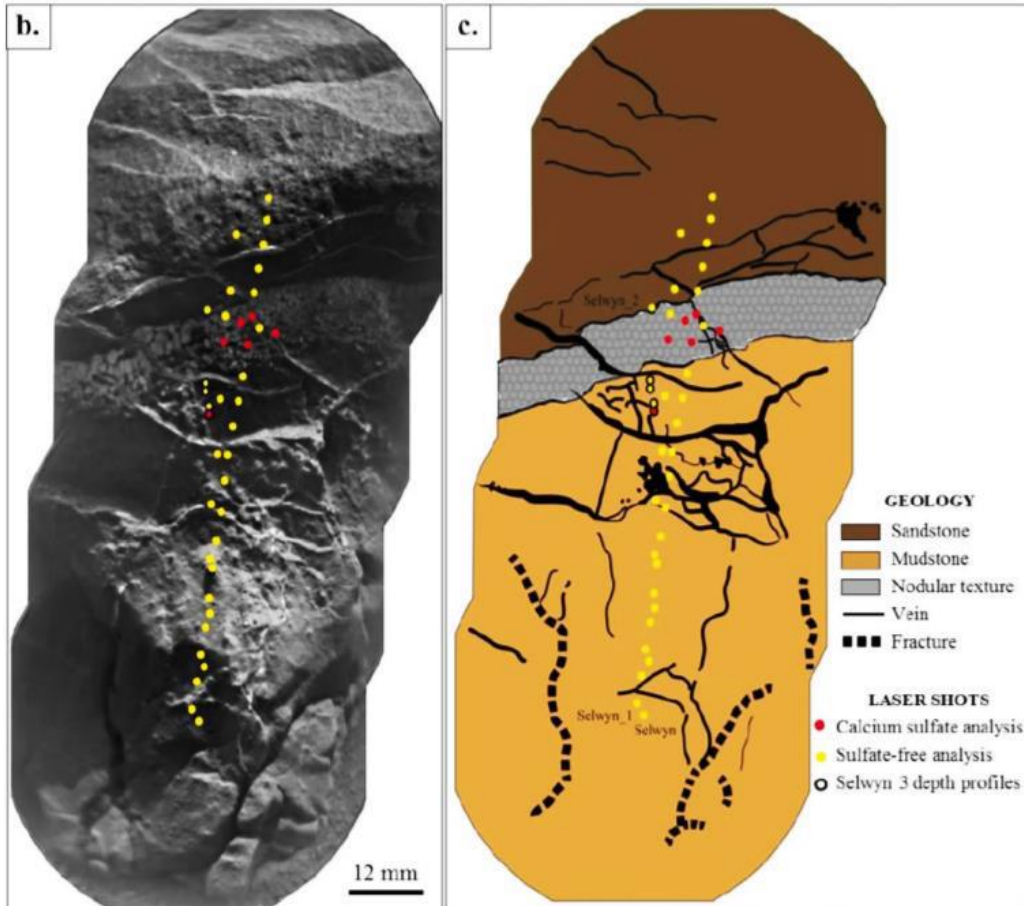

ChemCam was the first to observe and confirm the composition of the calcium sulfate veins in the Yellowknife Bay units. We were also able to show that the veins were variably hydrated

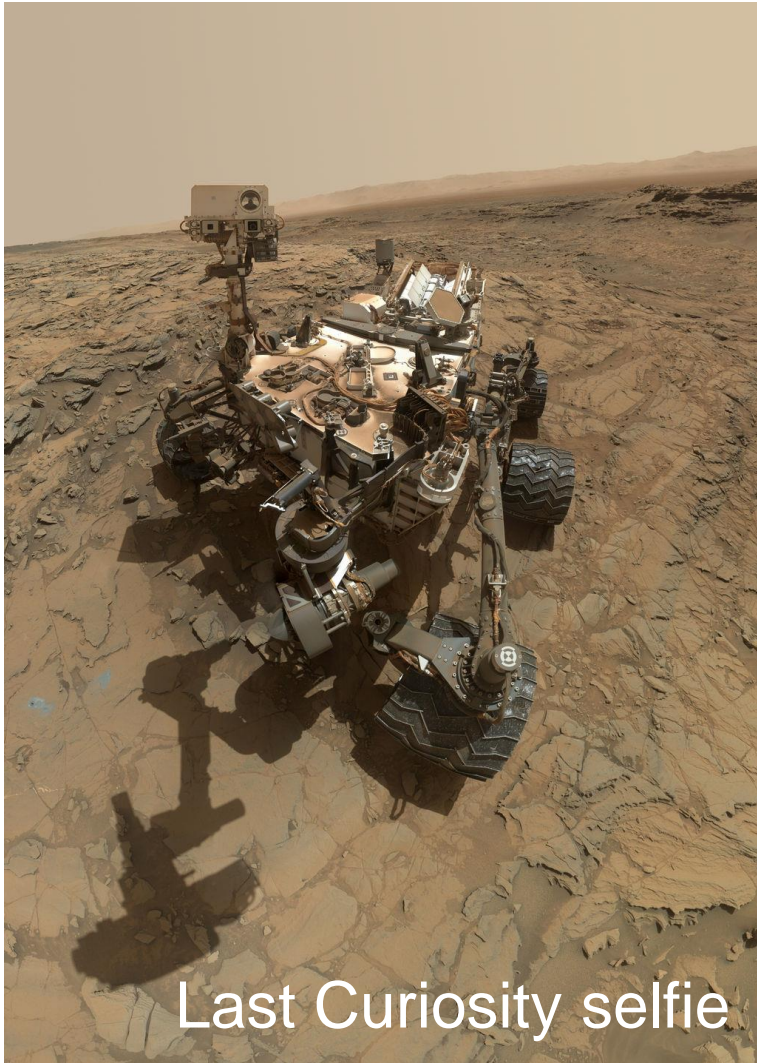

Last Curiosity selfie

Image credit NASA/JPL

And it still continues ...

OUR LIBS TEAM

Permanent staff :

- N. Coulon
- J.-L. Lacour
- D. L'Hermite
- C. Quéré
- J.B. Sirven
- E. Vors

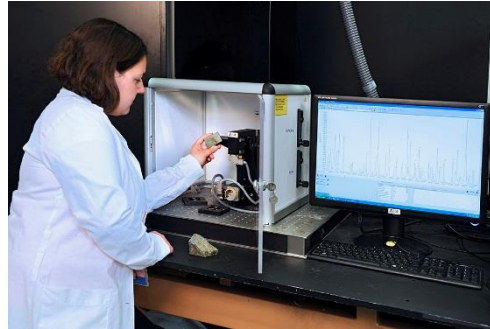

PhD's :

- Rawad Saad
- Jose Carlos Diaz-Rosado
(2012) (UNI Lima)
- Maria El Rakwe

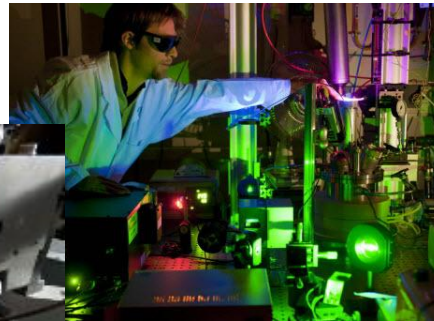
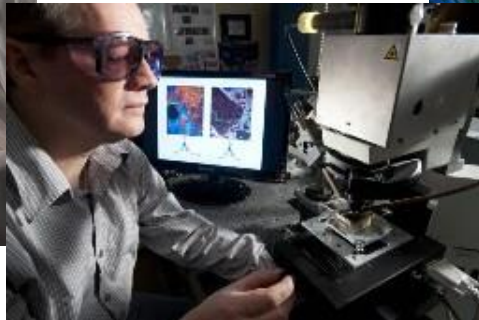
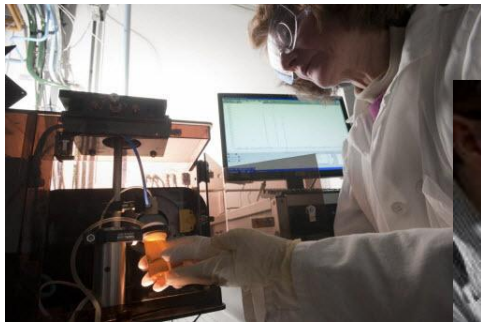

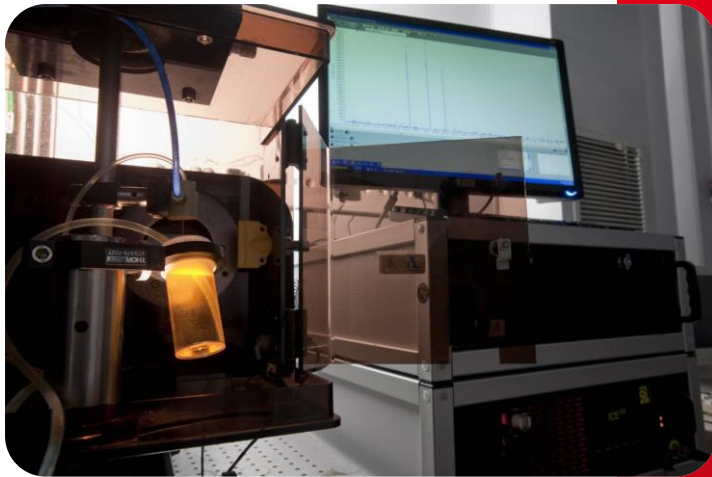

Thank's for
your attention

Muchas gracias
por su atención

Merci pour votre attention

Commissariat à l'énergie atomique et aux énergies alternatives
Centre de Saclay | 91191 Gif-sur-Yvette Cedex
T. +33 (0)1 69 08 32 51 | F. +33 (0)1 69 08 53 11

anthony.nonell@cea.fr

DEN/DANS/DPC/SEARS/LANIE

Etablissement public à caractère industriel et commercial | RCS Paris B 775 685 019