



**HAL**  
open science

## Premiers résultats du projet collaboratif FUI - MUSICAS

Olivier Asserin, Stephane Gounand

► **To cite this version:**

Olivier Asserin, Stephane Gounand. Premiers résultats du projet collaboratif FUI - MUSICAS : Méthodologie Unifiée pour la Simulation de l'Intégrité et la Contrôlabilité des Assemblages Soudés. Congrès NAFEMS France 2016 - Simulation numérique, moteur de performance, état de l'art : pratiques, tendances, impact industriel, Jun 2016, Paris, France. hal-02442269

**HAL Id: hal-02442269**

**<https://cea.hal.science/hal-02442269>**

Submitted on 16 Jan 2020

**HAL** is a multi-disciplinary open access archive for the deposit and dissemination of scientific research documents, whether they are published or not. The documents may come from teaching and research institutions in France or abroad, or from public or private research centers.

L'archive ouverte pluridisciplinaire **HAL**, est destinée au dépôt et à la diffusion de documents scientifiques de niveau recherche, publiés ou non, émanant des établissements d'enseignement et de recherche français ou étrangers, des laboratoires publics ou privés.

# PREMIERS RÉSULTATS DU PROJET COLLABORATIF FUI - MUSICAS



## Partenaires



## Financeurs



Yvelines  
Conseil général



direction générale de la compétitivité  
de l'industrie et des services



SERVIR L'AVENIR

## Méthodologie Unifiée pour la Simulation de l'Intégrité et la Contrôlabilité des Assemblages Soudés

1. Le projet vise l'introduction de logiciels existants dans une infrastructure métier pour automatiser des processus de simulation numérique du soudage depuis la CAO jusqu'à la durée de vie en passant par le procédé.
2. Valider et qualifier ces processus au meilleur état du savoir faire industriel par adossement à des cas test industriels.
3. Mise en place d'un démonstrateur d'une plateforme collaborative de simulation.

## FUI - MUSICAS

**Développer une simulation réaliste de procédés de soudage appliqués à des structures navales de fortes épaisseurs**

**Florent BRIDIER, Guillaume RÜCKERT**  
DCNS Research

# Soudage MAG d'un raidisseur épais (coque sous-marin)

- Soudage multipasse et caractérisation

- Soudage instrumenté (27 thermocouples)



- Mesure des contraintes résiduelles par couplage de différentes méthodes

- Technique du trou profond
- Méthode du contour

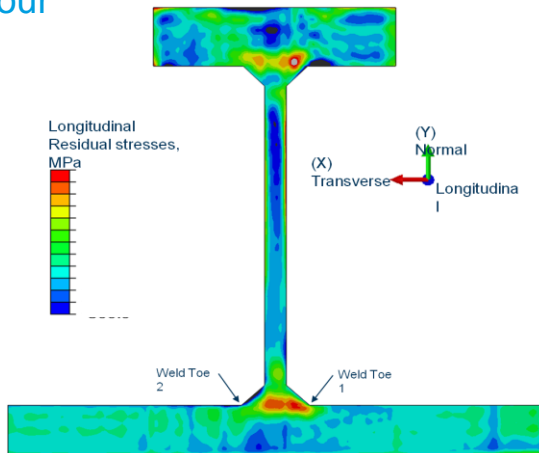

- Simulation numérique du procédé

- Implémentation lois de comportement thermo-métallo-mécanique
- Corrélation essais-calculs

Cinétiques thermiques simulées en bonne cohérence avec les mesures expérimentales

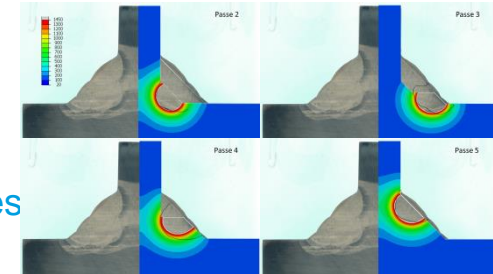

Bonne prédiction numérique de la distribution des contraintes résiduelles mais niveaux surévalués par le calcul

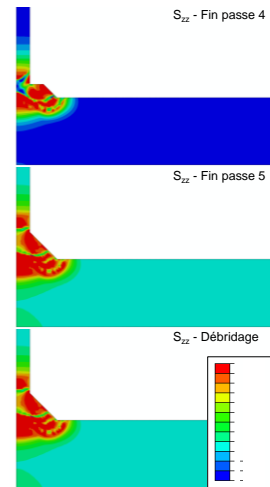
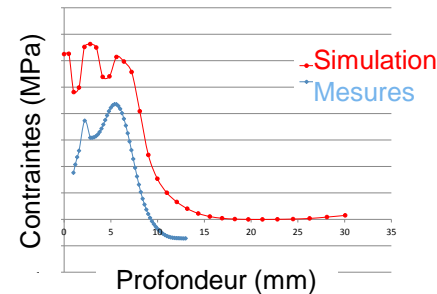

# Soudage FE d'un composant épais sous pression

- Soudage et caractérisation
  - Soudage instrumenté (17 thermocouples)

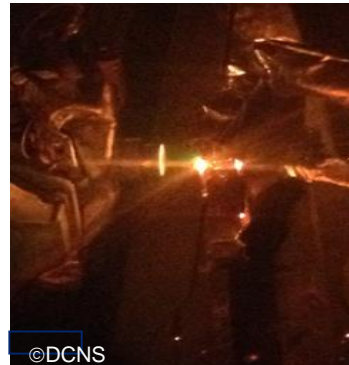

- Mesure des contraintes résiduelles par la méthode du trou profond

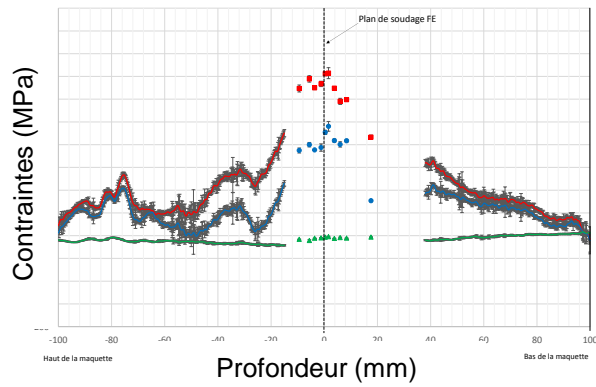

- Simulation numérique du procédé
  - Implémentation lois de comportement thermo-mécanique
  - Simulation 2D du soudage

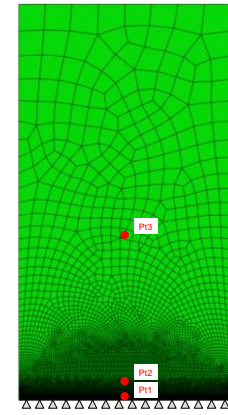
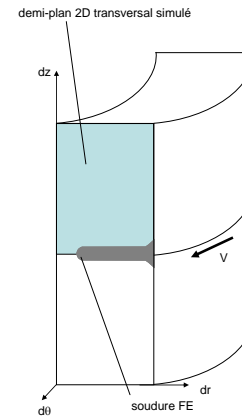

Identification de la distribution des contraintes en phase de soudage puis de refroidissement

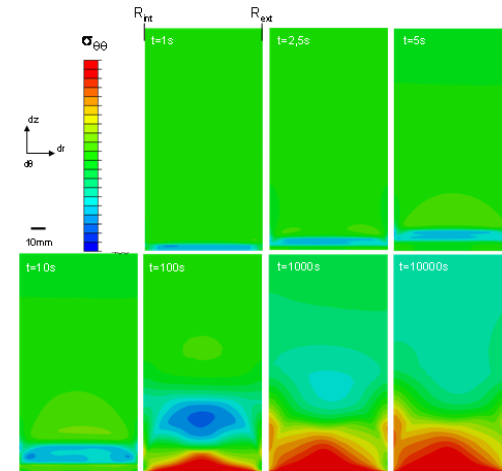

# FUI – MUSICAS

*Évaluer l'effet des contraintes résiduelles  
sur la tenue mécanique des assemblages*

*Anthony Reullier, Renault*



NAFEMS

8-9 JUIN 2016

CONFIDENTIAL   
PROPERTY OF GROUPE RENAULT

**GROUPE RENAULT**



# Filière calcul process/produit : Clio III

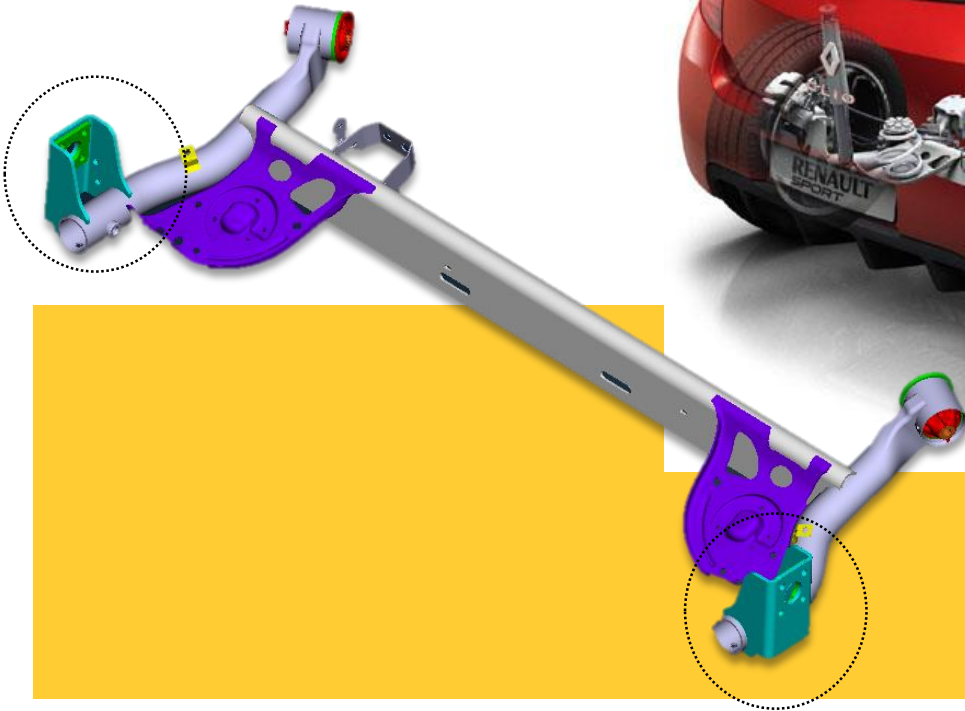

NAFEMS

8-9 JUIN 2016

CONFIDENTIAL   
PROPERTY OF GROUPE RENAULT

**GROUPE RENAULT**



# Filière calcul process/produit : de la CAO à la durée de vie

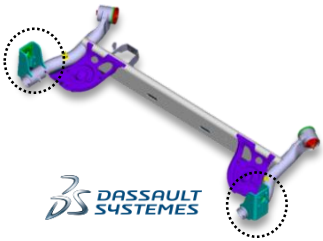

CAO – Maillage

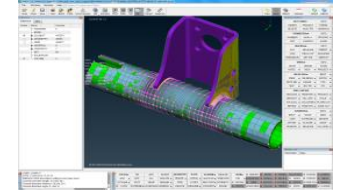
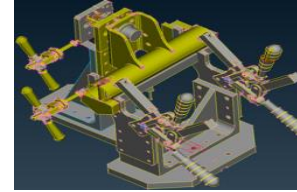

Calcul thermo-métallo-mécanique  
Contraintes résiduelles et Distorsions

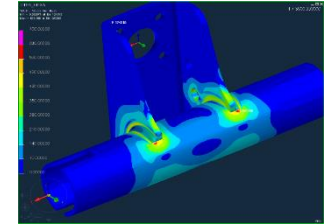
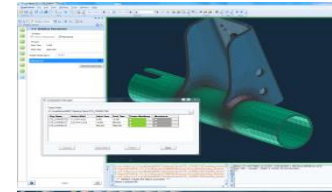

Calcul mécanique  
Contraintes de « service » avec prise en compte des contraintes résiduelles/distorsions de soudage

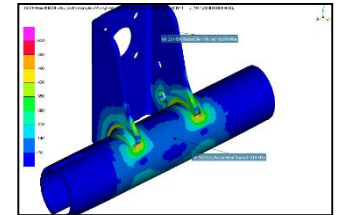
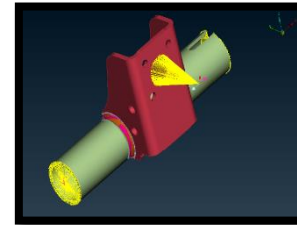

Estimation durée de vie (courbe Wöhler)

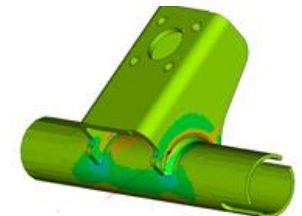
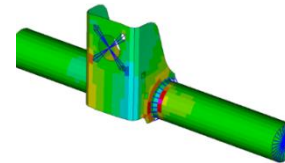

ABAQUS

nCode DesignLife



# Du cas test au problème industriel

2 cordons de soudure

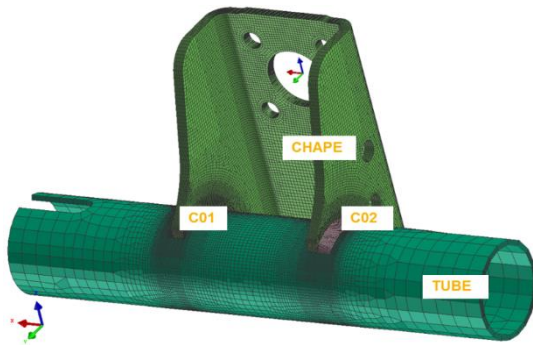

16 cordons de soudure

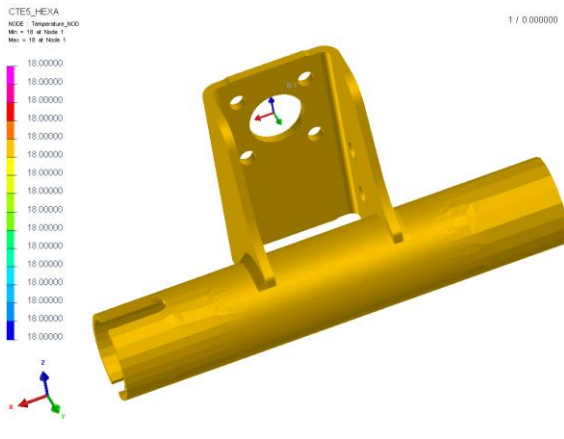
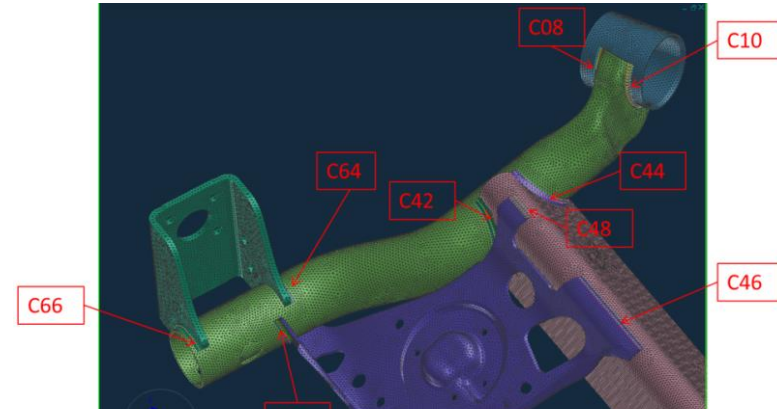



# FUI - MUSICAS

## Apports du projet MUSICAS pour la fabrication, la contrôlabilité et la DDVie des composants nucléaires

***P. Gilles, G. Tirand, E. Jourden, V. Robin – AREVA NP***

RESTRICTED AREVA

*The information in this document is AREVA property and is intended solely for the addressees.*

*Reproduction and distribution are prohibited. Thank you*

**Engineering & Projects Organization**

**AREVA**  
forward-looking energy



# Fabrication : contraintes et distorsions

## L'assemblage des composants

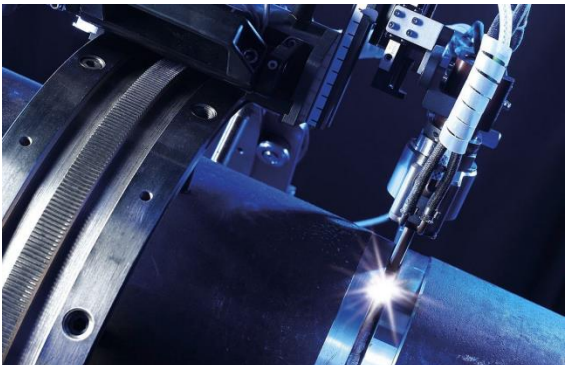

## Les prédictions numériques

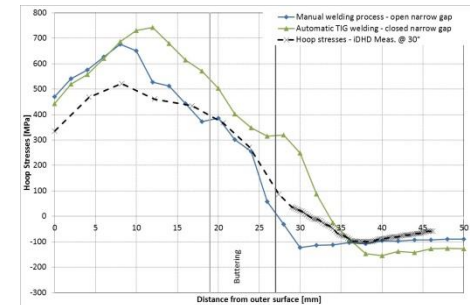
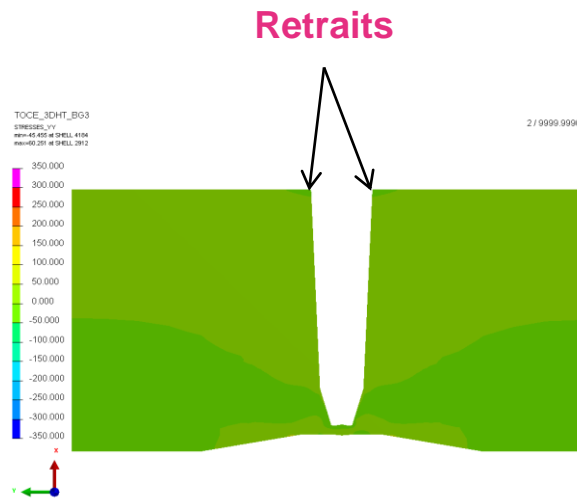

## Contraintes résiduelles



**AREVA**  
forward-looking energy



# Contrôlabilité : microstructure et texture en soudage multipasse

## La soudure



Engineering & Projects Organization

## Le modèle

Modèles multiphysiques et thermo-métallurgie avancés (couplage CAFE)

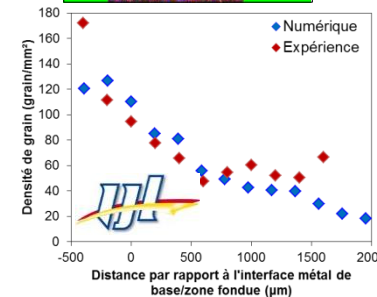
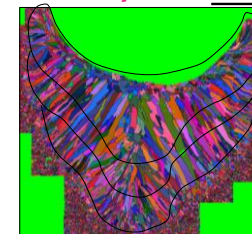
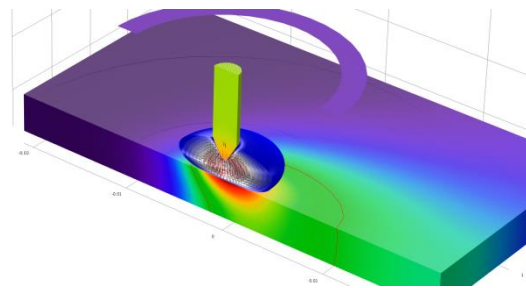

**AREVA**  
forward-looking energy



# DDVie : effets du soudage sur le comportement en fatigue

Les essais, les lois pour le design

La maquette

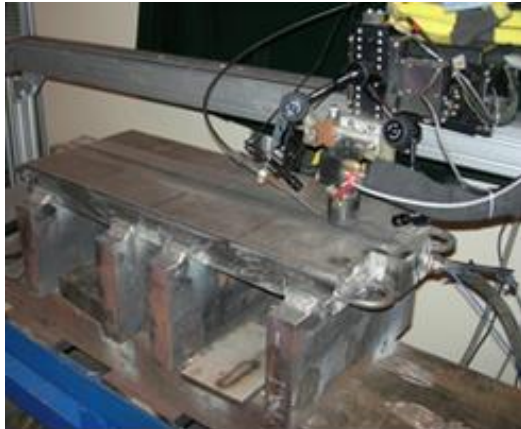

Fatigue oligocyclique

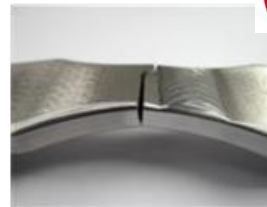
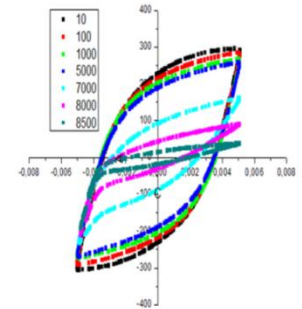
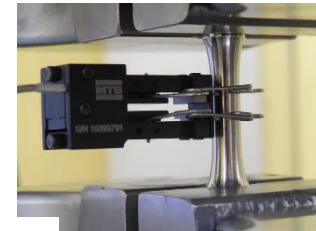

Engineering & Projects Organization

**AREVA**  
forward-looking energy



# FUI - MUSICAS

# Cas de validation simplifiés (éprouvettes)

- Partenariat PSA - ARCELOR
- 3 Matériaux, 3 géométries
- Analyses :
  - Métallurgie
  - Contraintes résiduelles
  - Tenue en Fatigue
- Support de validation pour la simulation numérique (métallurgie, CR)
- Support de détermination des données fatigue



Clin 3 tôles



T



Micrographies

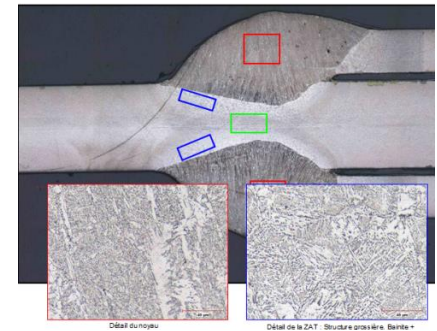

Détermination des contraintes résiduelles par DRX

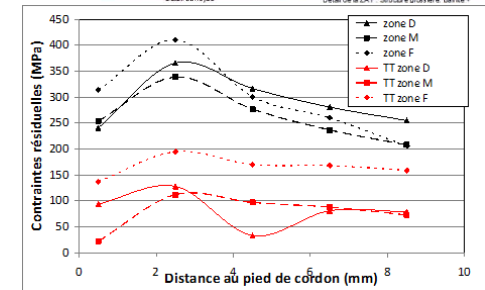

Simulation de l'essai sur éprouvette en T

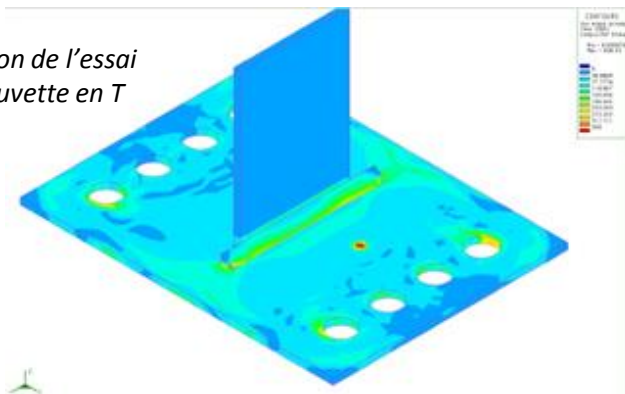

Essai de fatigue

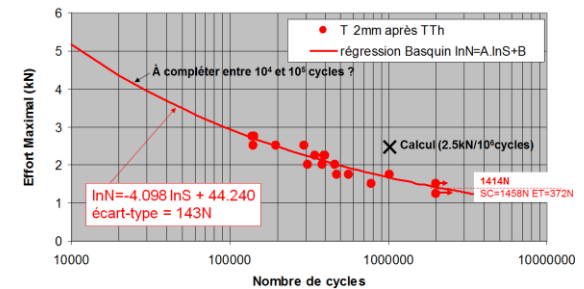

# Cas de validation industriel (Triangle)

## ■ Application de la méthodologie cible :

- Simulation du procédé de soudage avec SYSWELD
- Import des contraintes résiduelles et simulation du chargement avec ABAQUS
- Analyse de la tenue en fatigue avec DesignLife (critère de Dang Van)

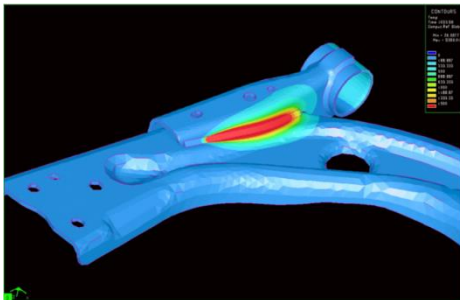

*Simulation thermomécanique du soudage*

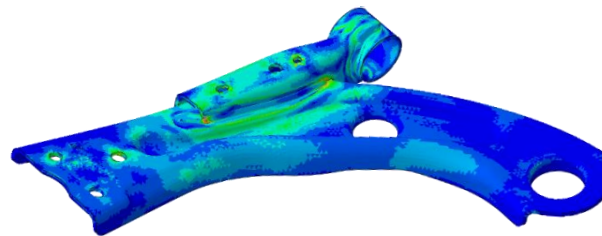

*Simulation du chargement avec prise en compte des contraintes résiduelles de soudage*

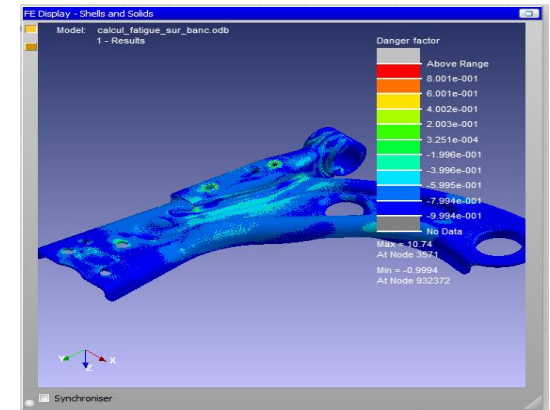

*Analyse de la tenue en fatigue*



# FUI-MUSICAS

## Atelier CAO / Maillage

F. Koechlin, A. Crepy, M. Rioult

- Génération de la CAO et du maillage d'un assemblage soudé à partir de :
  - Pièces unitaires à assembler
  - Catalogue d'assemblages prédéfinis
- Génération d'une soudure multipasse

### 1 - CAO de l'assemblage avec génération de la soudure et découpes

### 2 - Maillage de l'assemblage

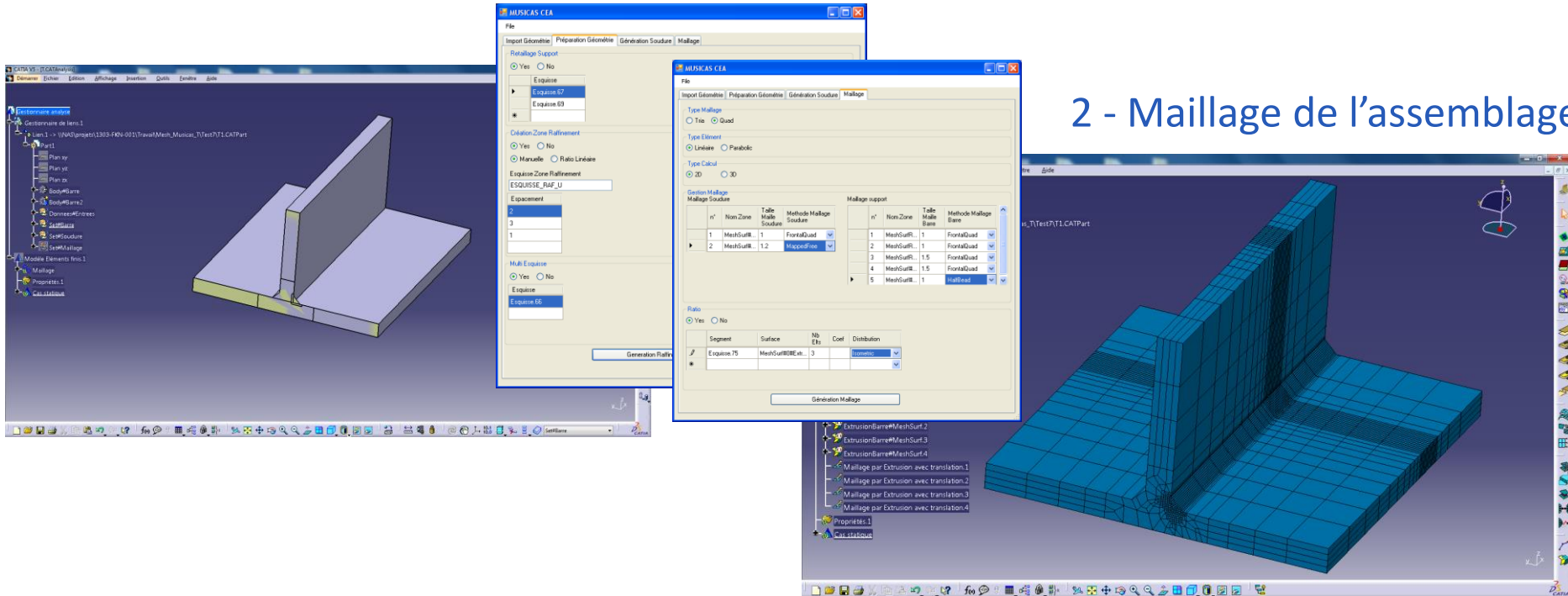

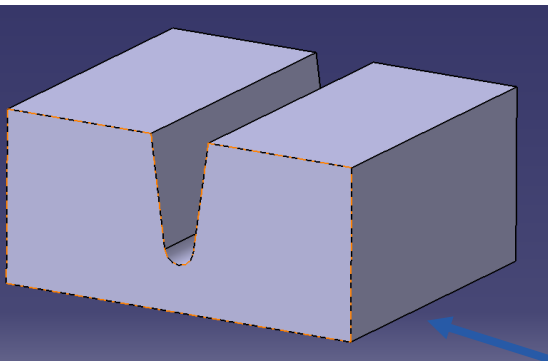

Soudure de forte épaisseur en chanfrein

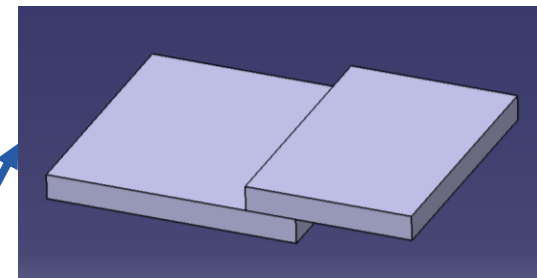
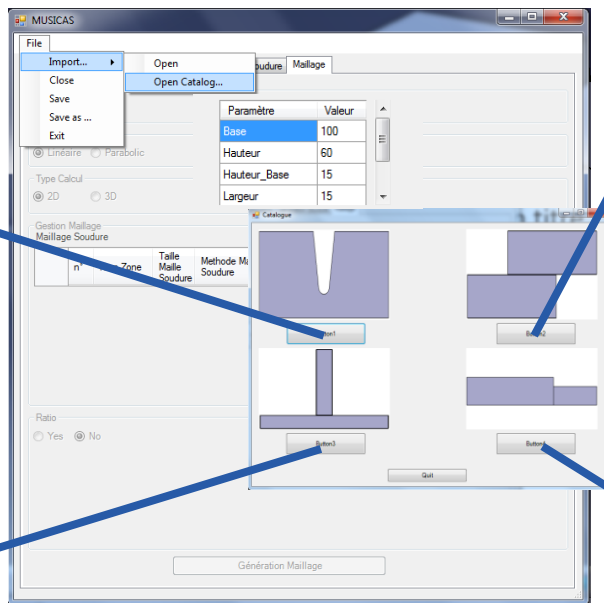

Soudure à clin

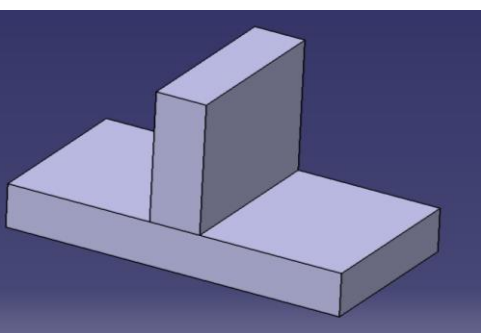

Soudure d'angle (en té)

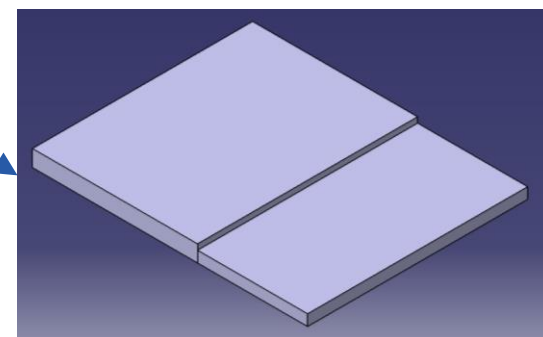

Soudure à plat bord à bord

### Soudage multipasse forte épaisseur en chanfrein étroit

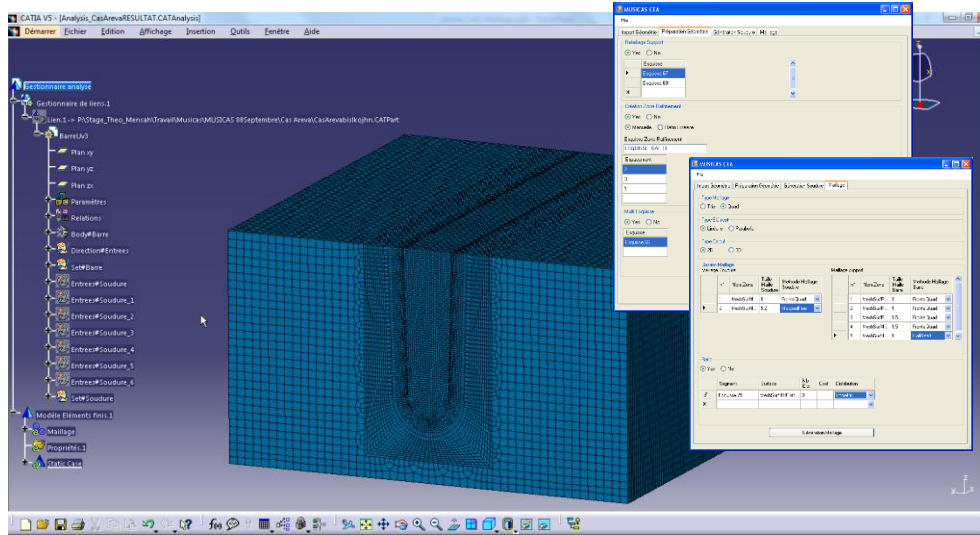
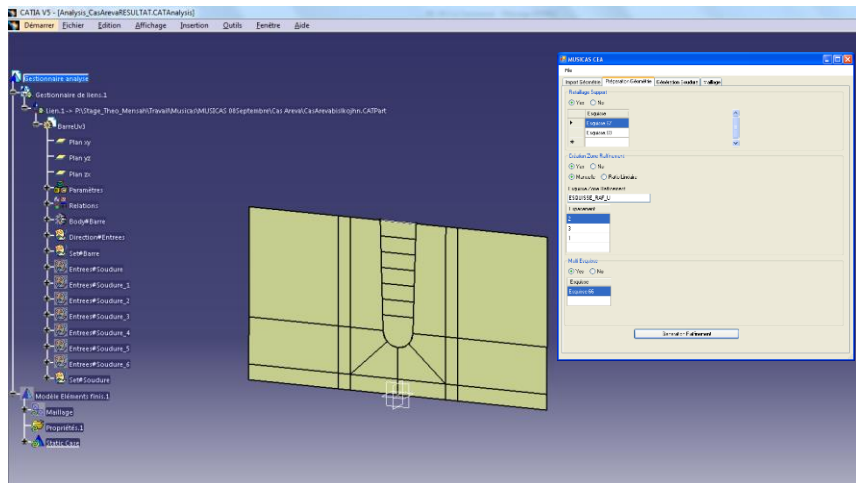
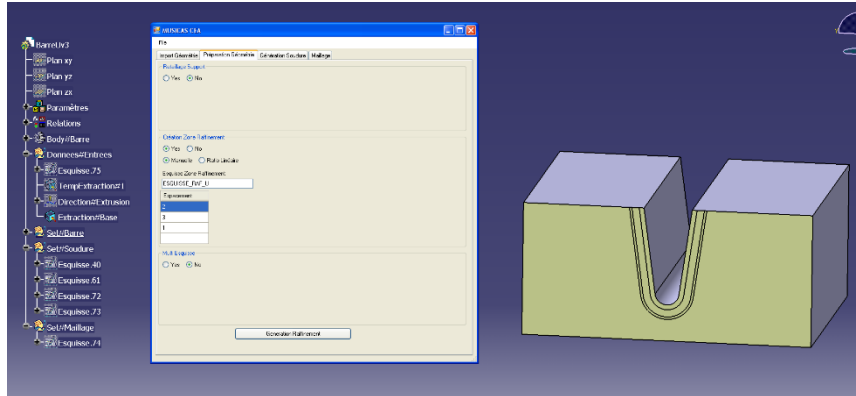
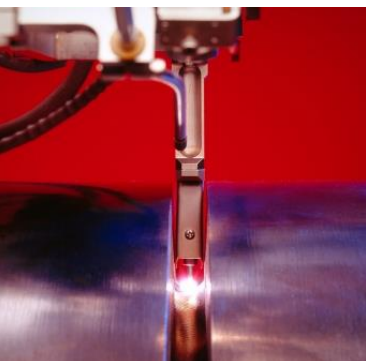
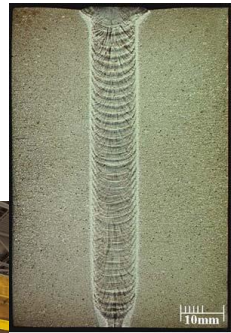
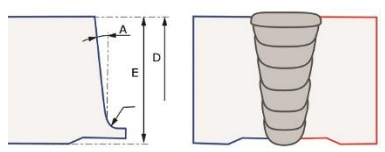



# LOGICIEL WPROCESS ET MODÉLISATIONS MULTIPHYSIQUES POUR LE SOUDAGE FUI – MUSICAS

Stéphane Gounand, Olivier Asserin - cea

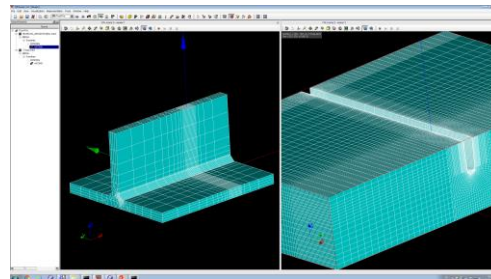

Logiciel WPROCESS (Castem)

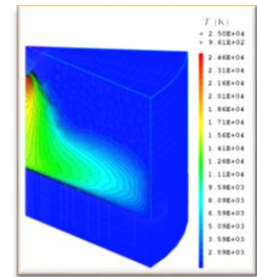
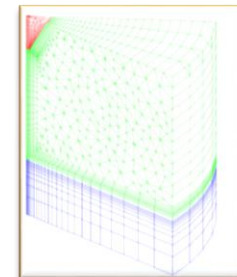

Simulation multiphysique de l'arc

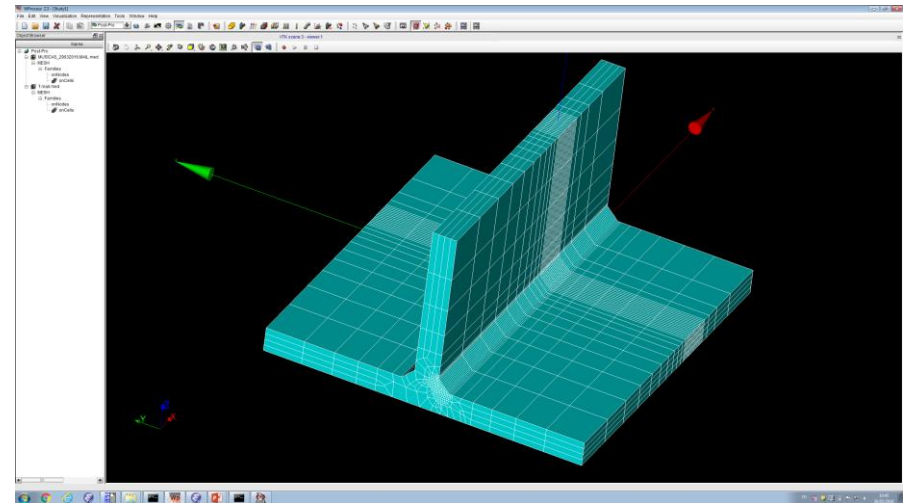
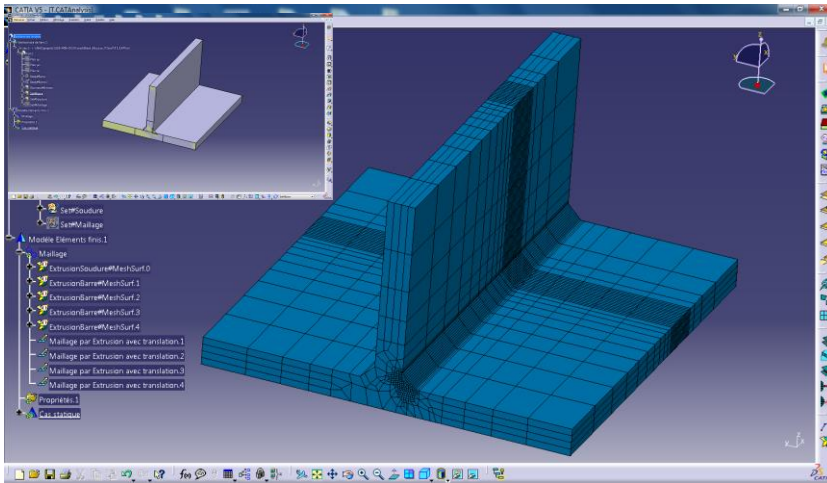

Atelier CAO – géométrie et maillage



WPROCESS – Import et simulation depuis l'atelier CAO

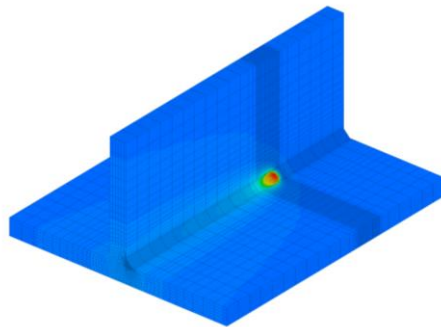

Températures

Simulation Multiphysique

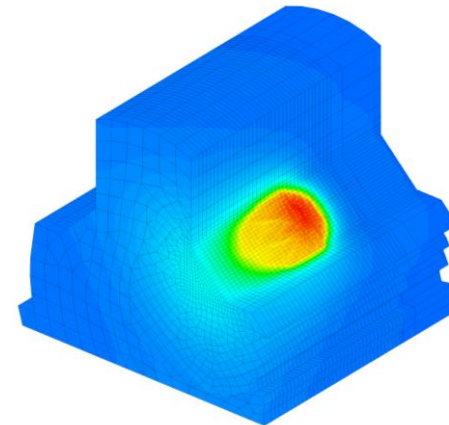

Températures et vitesses dans le bain de soudage

Atelier CAO/MAILLAGE

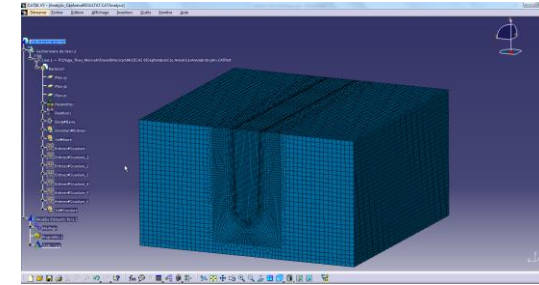
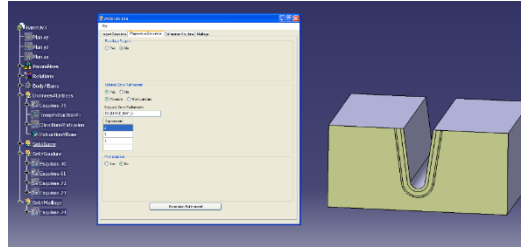

WPROCESS

Simulation du procédé

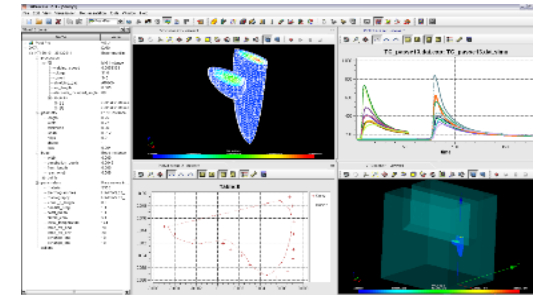
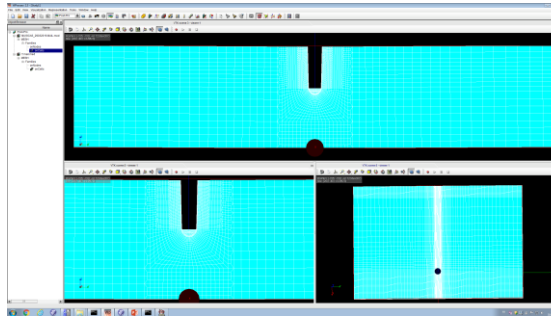

SYSWELD

Simulation des contraintes résiduelles

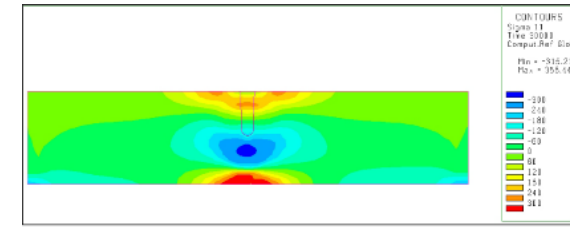
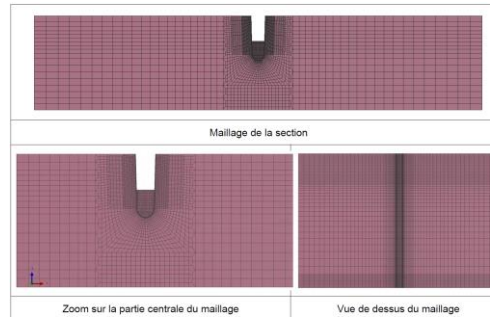

Contrainte transversale

Figure 10 : Source MUSICA - Maillage tridimensionnel pour le calcul stationnaire

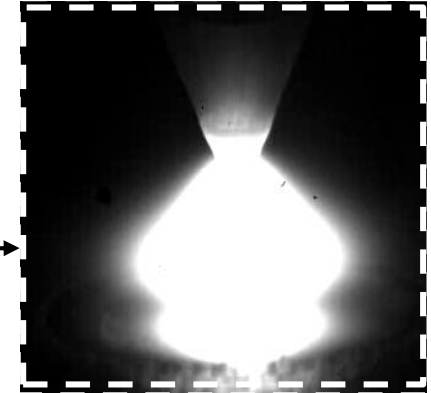
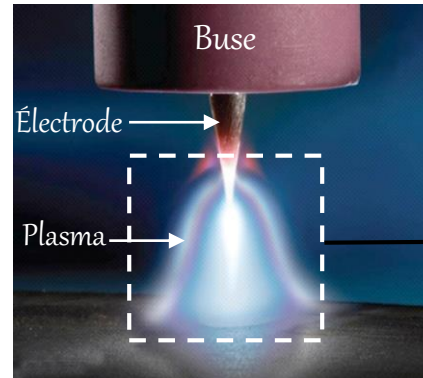
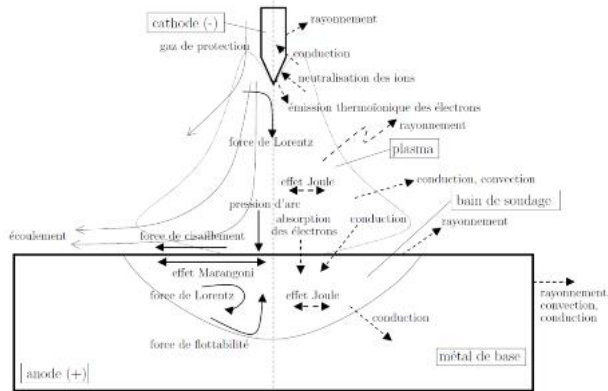

Soudage à l'arc TIG

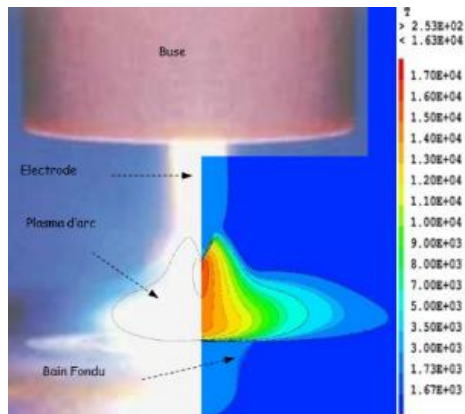

Soudage à l'arc TIG  
(Simulation 2D)

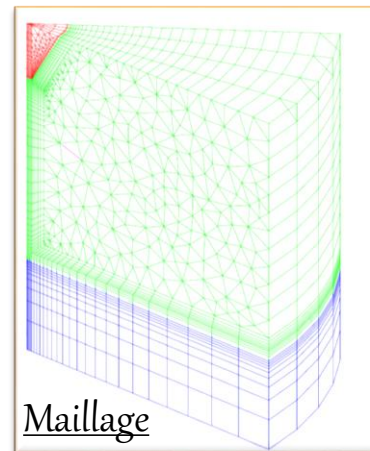

Soudage à l'arc TIG  
(Simulation 3D)

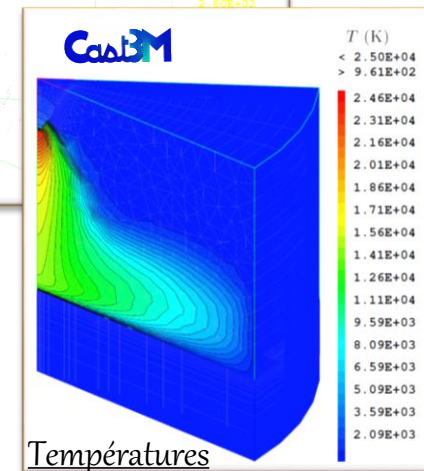
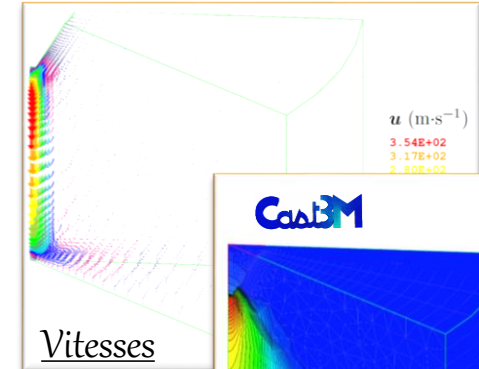

# FUI - MUSICAS

Interaction fluide structure: couplage multiphysique et mécanique  
Modèles thermomécaniques avancés : lien avec la durée de vie et la  
simulation du contrôle non destructif



Frédéric BOITOUT, Mickaël FONTAINE

# Realistic modeling of weld pool and mushy zone coupled with robust finite elements in SYSWELD

Easy automated meshing of complex shapes with robust tetrahedral formulation: mixed elements<sup>(1)</sup> P1+/P1, P1/P1 (displacement / pressure formulation)

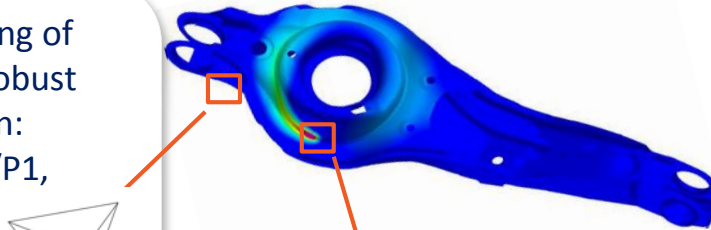

Surface tension

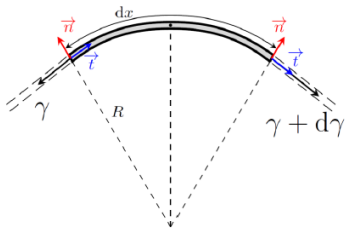

Temperature

$T_L$   
 $T_s$

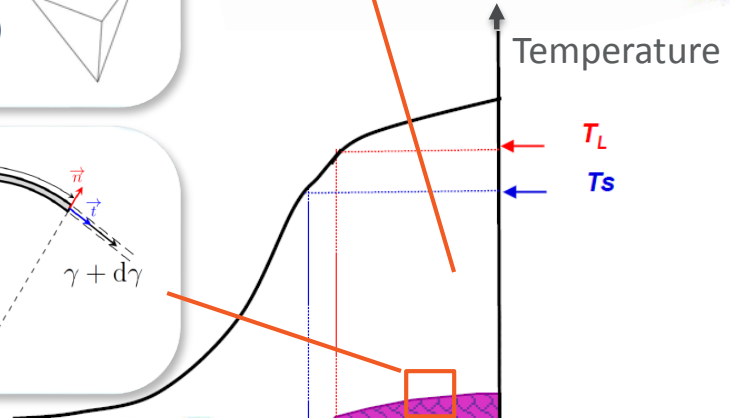

Behavior Law<sup>(1)</sup>:



- Newtonian fluid in liquid state ( $T > T_L$ )
- Elasto-viso-plastic behavior in solid state ( $T < T_s$ ) with mixed isotropic/kinematic hardening
- Mixed law in Mushy zone

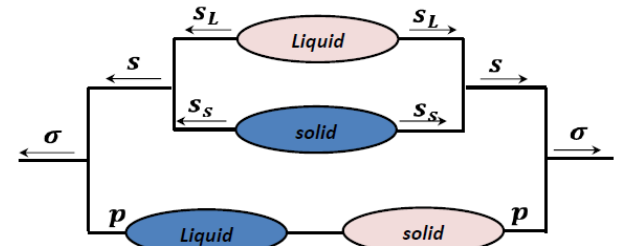

Microstructure evolution during solidification<sup>(2)</sup> (CA-FE model / Hunt's CET model)

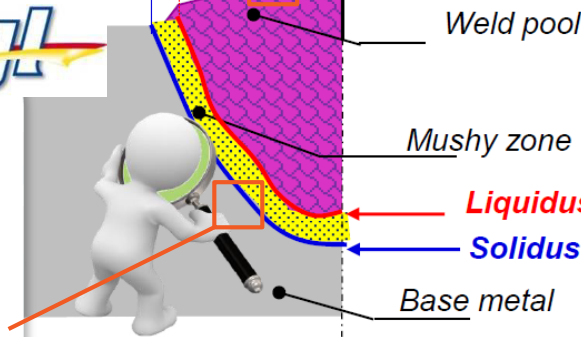

Non-Destructive Inspection

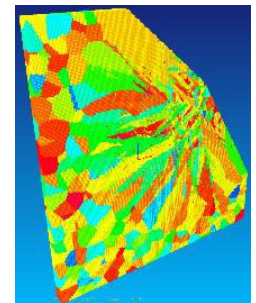

(1) H. Sallem, E. Feulvarch, H. Amin-El-Sayed, B. Souloumiac, J.-B. Leblond, J. Michel Bergheau, Recent advances in residual stress simulation caused by the welding process, in: Int. Conf. Comput. Plast. Fundam. Appl. COMPLAS XIII, Barcelone, Spain, 2015: pp. 1–12.  
 (2) T. Billotte *et al.*, Caractérisation microscopiques pour la simulation des structures soudées par chaînage SYSWELD / Automate Cellulaire, 14<sup>ème</sup> colloque du GST SNS, Paris, 2016

# Integration of ESI products in a remote software chain dedicated to numerical simulation of welding

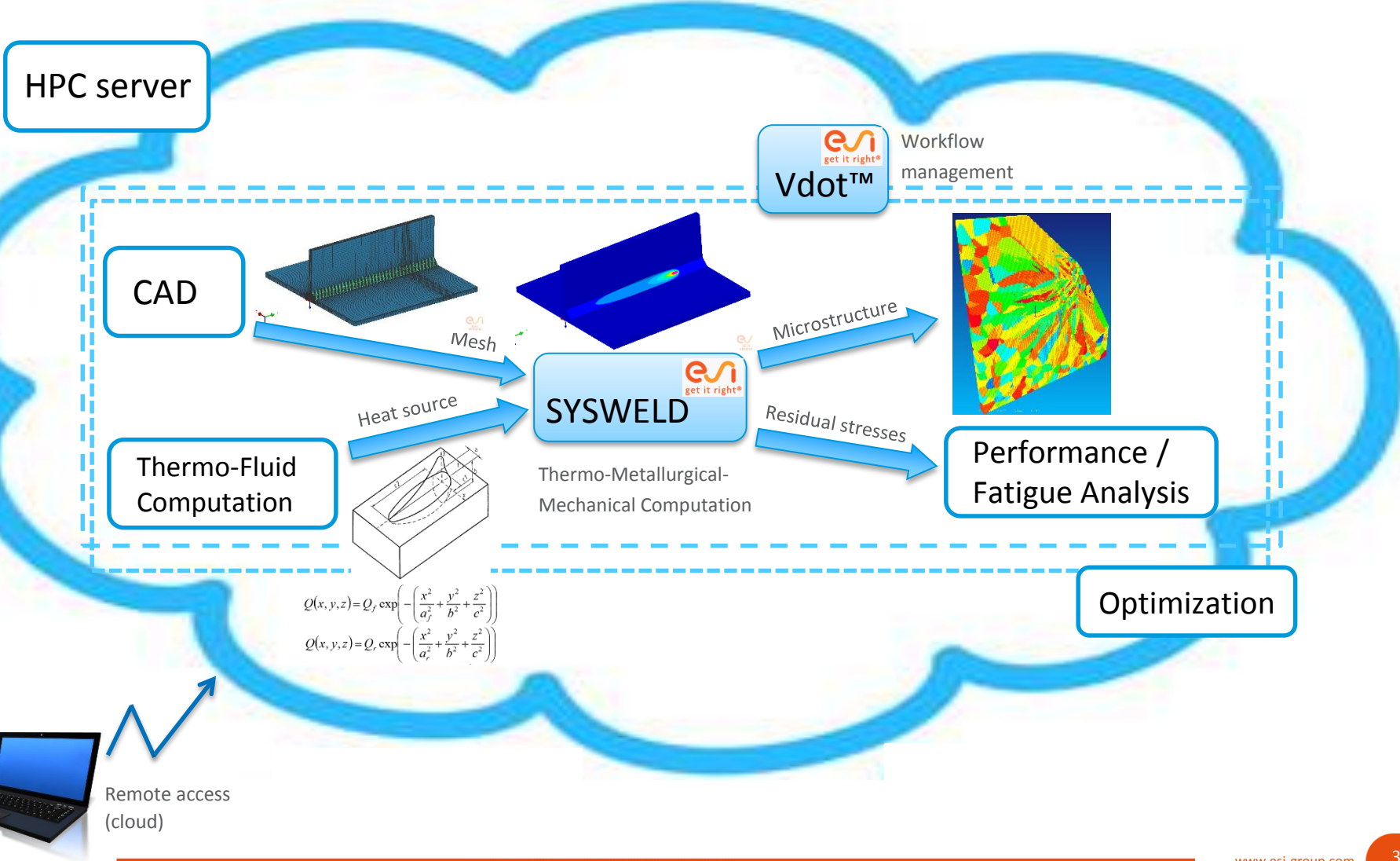



**FUI – MUSICAS**  
**PLATEFORME COLLABORATIVE DE SIMULATION**

**B. DIASSE, M. DREANO**





# Fonctionnement de la plateforme MUSICAS

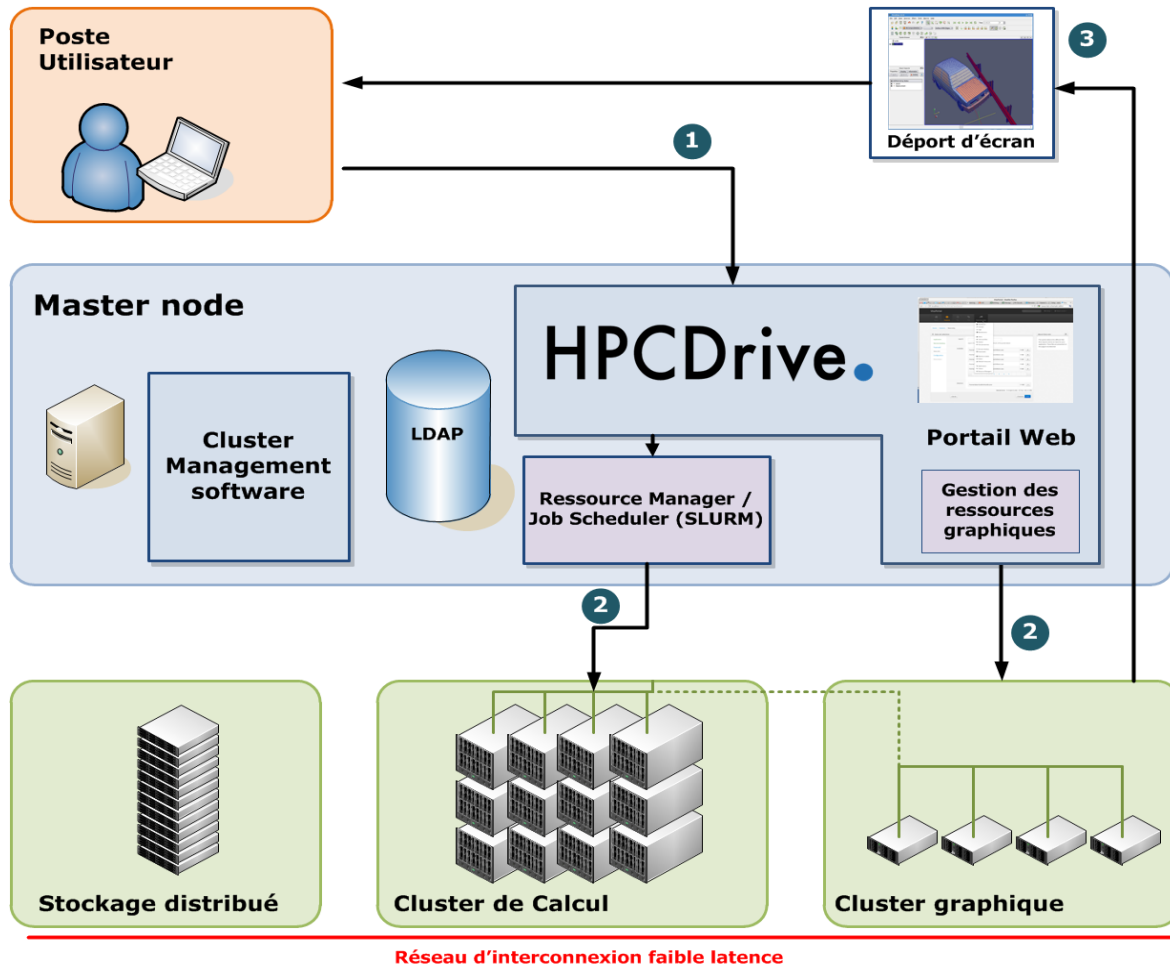

# Exemples d'outils logiciels intégrés dans la plateforme MUSICAS

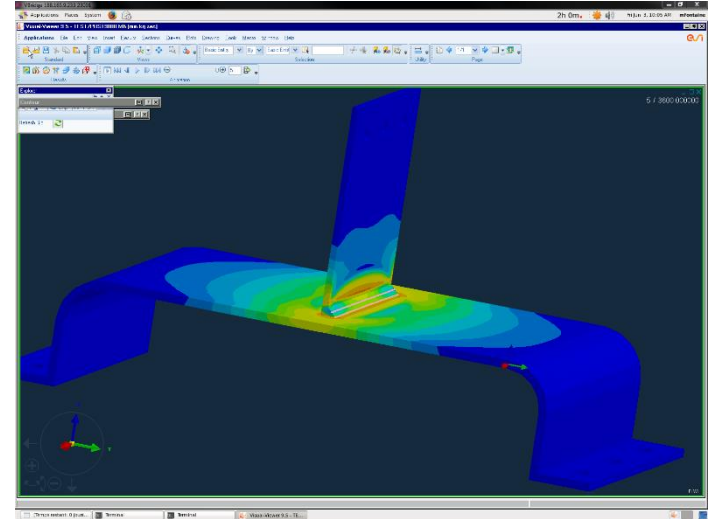
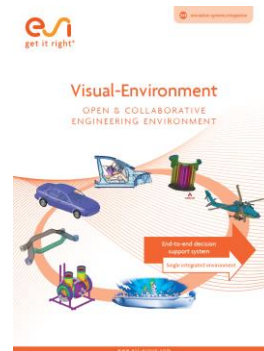
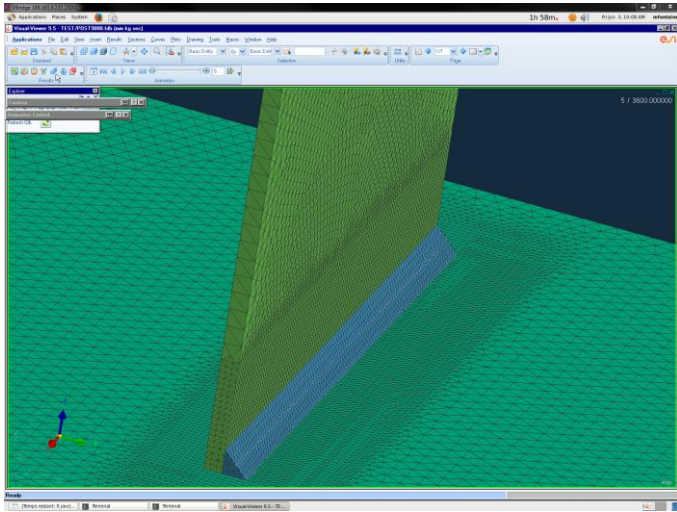

- SYSWELD
- Visual-Environment
- modeFRONTIER
- WProcess

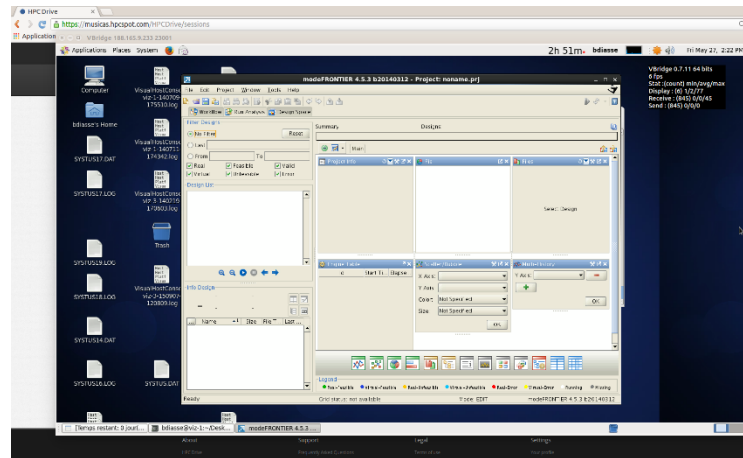

3 objectifs : de la CAO à la DDVie, simuler des cas test industriels, une plateforme de simulation collaborative.

- La possibilité de considérer les prédictions par SNS\* (texture, état résiduel) au sein d'une chaîne d'outils logiciels comme données pour assurer la qualité des assemblages : contrôlabilité et DDVie. Par exemple, pour améliorer les capacités de prédiction de la tenue en endurance des cordons de soudure via la prise en compte des contraintes résiduelles (cas test industriels de Areva, Renault, PSA).
- La possibilité d'utiliser la SNS\* sur la plateforme de simulation MUSICAS avec la simulation de 16 cordons de soudure pour le cas test industriel de Renault.
- De part les nombreux phénomènes physiques mis en jeu dans le soudage, sa simulation et celle de ses effets requiert une pluralité de compétences et autant de spécialistes. L'assemblage des compétences est une véritable réussite de l'initiative MUSICAS. De part la mise en commun de savoir-faire, de méthodologies et l'accès à des outils logiciels, MUSICAS aura permis aux partenaires d'acquérir de nouvelles méthodologies de simulation et d'instrumentation, et de découvrir les capacités et les possibilités d'applications des outils logiciels MUSICAS, ouvrant la perspective de nouvelles utilisations industrielles.

**SNS\*** : *Simulation Numérique du Soudage*

---

Commissariat à l'énergie atomique et aux énergies alternatives  
Centre de Saclay | 91191 Gif-sur-Yvette Cedex  
T. +33 (0)1 XX XX XX XX | F. +33 (0)1 XX XX XX XX

Direction DEN/DANS  
Département DM2S  
Service SEMT

Etablissement public à caractère industriel et commercial | R.C.S Paris B 775 685 019