



HAL
open science

Nanoporous scintillators for radioactive gas detection

Raphaël Marie-Luce, Pavlo Mai, Frédéric Lerouge, Yannis Cheref, Sylvie Pierre, Benoit Sabot, Frédéric Chaput, Christophe Dujardin

► To cite this version:

Raphaël Marie-Luce, Pavlo Mai, Frédéric Lerouge, Yannis Cheref, Sylvie Pierre, et al.. Nanoporous scintillators for radioactive gas detection. 12th international conference on Luminescent Detectors and Transformers of Ionizing Radiation, University of Latvia; European Radiation Dosimetry Group (EURADOS); SIA Baltic Scientific Instruments, Jun 2024, Riga, Lithuania. cea-04938900

HAL Id: cea-04938900

<https://cea.hal.science/cea-04938900v1>

Submitted on 10 Feb 2025

HAL is a multi-disciplinary open access archive for the deposit and dissemination of scientific research documents, whether they are published or not. The documents may come from teaching and research institutions in France or abroad, or from public or private research centers.

L'archive ouverte pluridisciplinaire **HAL**, est destinée au dépôt et à la diffusion de documents scientifiques de niveau recherche, publiés ou non, émanant des établissements d'enseignement et de recherche français ou étrangers, des laboratoires publics ou privés.



Porous scintillators for radioactive gas detection

R.Marie-Luce², P.Mai¹, F.Lerouge², Y.Cheref^{1,2}, S.Pierre³, B.Sabot³,
F.Chaput², and C. Dujardin^{1,4,*}

¹ *Institute of Light and Matter, University Claude Bernard Lyon1, CNRS UMR 5306*

² *Laboratoire de Chimie ENS-Lyon, University Claude Bernard Lyon1, CNRS UMR 5182*

³ *CEA,LIST, Laboratoire National Henri Becquerel (LNE-LNHB), University Paris Saclay*

⁴ *Institut Universitaire de France (IUF)*



This project has received funding from the European Union's Horizon 2020 research and innovation programme under grant agreement No 899293

Context: detection of particular radioactive gases

It exists various kinds of radioactivities

Type	Nuclear equation	Representation	Change in mass/atomic numbers
Alpha decay	${}^A_ZX \rightarrow {}^4_2\text{He} + {}^{A-4}_{Z-2}Y$		A: decrease by 4 Z: decrease by 2
Beta decay	${}^A_ZX \rightarrow {}^A_{Z+1}Y + {}^0_{-1}e$		A: unchanged Z: increase by 1
Gamma decay	${}^A_ZX \rightarrow {}^A_ZY + {}^0_0\gamma$		A: unchanged Z: unchanged
Positron emission	${}^A_ZX \rightarrow {}^A_{Z-1}Y + {}^0_{+1}e$		A: unchanged Z: decrease by 1
Electron capture	${}^A_ZX + {}^0_{-1}e \rightarrow {}^A_{Z-1}Y + \text{X-ray}$		A: unchanged Z: decrease by 1

Context: γ -ray emitters

A common situation: as an illustration ^{137}Cs

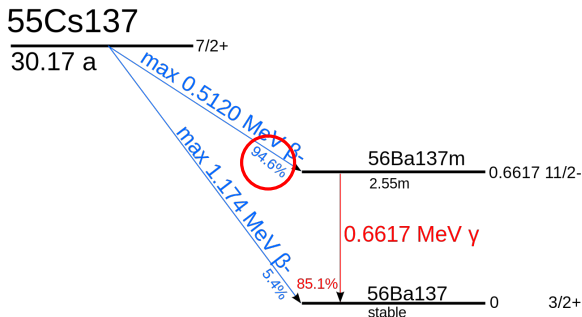

Here, it is easy to detect the γ with mature technologies (even from far since γ -rays can travel in air)

Context: case of pure β -ray emitters

But in some cases

High probability toward the ground state

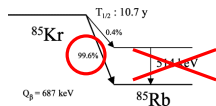

→ Almost no γ -rays

Only a ground state

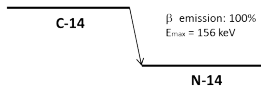

→ no γ -rays

Only a ground state

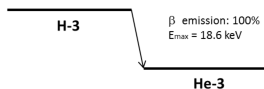

→ no γ -rays

Here, no γ -rays → need to detect the β (electron)
(these 3 are really critical for the survey of nuclear power plants)

Context: societal impact

For production (case of various reactor technologies)

Table 6.3 Annual release of radionuclides (per GWe of electricity generation) from nuclear reactors (based on the data reported for the 1990–1994 period) (data source: UNSCEAR 2000)

	Normalized release per GWe of electricity generation (TBq per GWe per year)						
	Airborne Release				Liquid Release		
	Noble gas (¹³³ Xe, ¹³⁵ Xe, ⁸⁵ Kr)	³ H	¹⁴ C	¹³¹ I	Particulates (mostly as ⁸⁸ Rb, ⁸⁹ Rb, ¹³⁹ Ba)	³ H	Other (⁹⁰ Sr, ¹³⁷ Cs, ⁵¹ Cr, ⁵⁴ Mn, ⁵⁸ Co, ⁶⁰ Co, and ⁹⁵ Zr)
PWR	27	2.3	0.22	0.0003	0.0002	22	0.019
BWR	350	0.94	0.51	0.0008	0.18	0.94	0.043
GCR	1600	4.7	1.4	0.0014	0.0003	220	0.51
HWR	2100	650	1.6	0.0004	0.00005	490	0.13
LWGR	1700	26	1.3	0.007	0.014	11	0.005
FBR	380	49	0.12	0.0003	0.012	1.8	0.049
Total	330	36	0.44	0.0007	0.040	48	0.047
Total combined release: 415 (TBq)							

For reprocessing of nuclear fuel

Table 6.4 Annual average release of radioactivity from reprocessing (as release in TBq per GWe of electricity generation during the period 1990–1994) (data source: UNSCEAR 2000)

	Airborne release	Liquid release
³ H	24	270
¹⁴ C	0.4	0.8
⁸⁵ Kr	6300	–
⁹⁰ Sr	–	2.0
¹⁰⁶ Ru	–	2.1
¹²⁹ I	0.001	0.03
¹³¹ I	9×10^{-5}	–
¹³⁷ Cs	8×10^{-5}	1.03

Yim M.S. Generation of nuclear Waste from Nuclear Power, (Springer) Netherlands, Dordrecht, 2022

→ Need for an efficient and real-time detector for these ones

Context: very short penetration in air

But

Simulated trajectories of 5 keV electrons in air

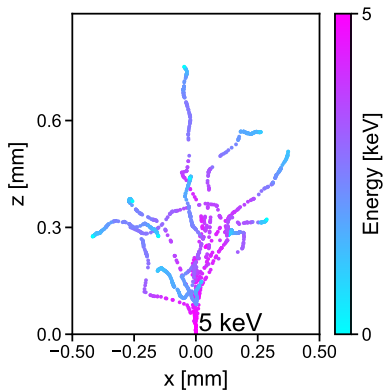

Remaining energy at various distances from the initial point.

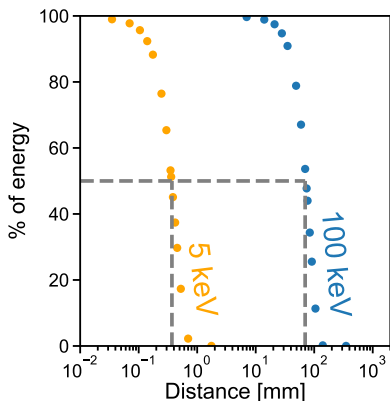

Context: very short penetration in air

calculations for ^3H and ^{85}Kr

Simulated energy distributions

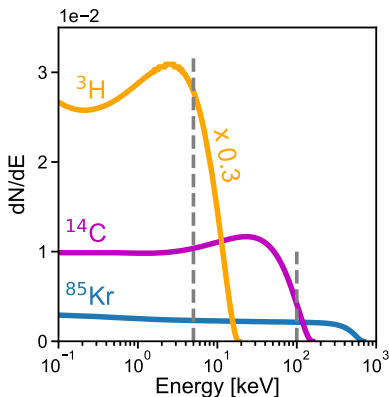

Efficiency of detection (1 keV limit)

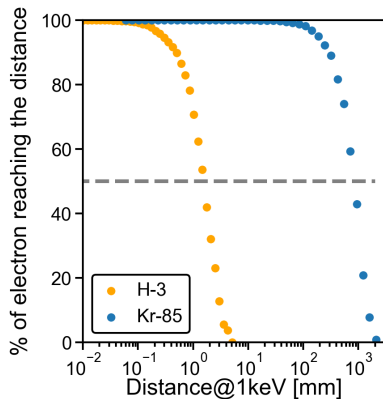

→ the ideal detection system needs to mix the gaz with the sensor !

→ the element to be detected has to be intermixed with the sensor

gaz - liquid mixing

bubbling the gaz in liquid
scintillator



- ≈ 1 week for 1 measurement
- only for 3H
- organic wastes

→ the element to be detected has to be intermixed with the sensor

gaz - liquid mixing

bubbling the gaz in liquid
scintillator



- ≈ 1 week for 1 measurement
- only for 3H
- organic wastes

gaz - gaz mixing

proportionnel counter



- ≈ 150 k€
- requires a carrier gaz
- fragile and sensitive electronics

→ can we do better with gaz-solid mixing approach?

Material science strategy for gaz-solid mixing

The concept of porous scintillator: the scintillating sponge

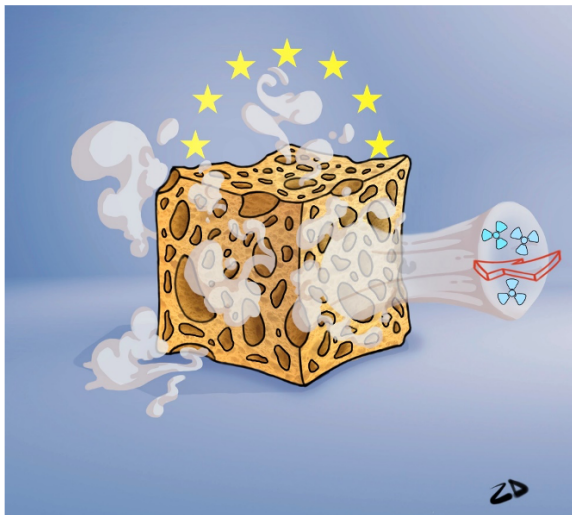

Material science strategy for gaz-solid mixing

Main requirements: a few cm sizes, transparent, bright and fast



Material science strategy for gaz-solid mixing

transparent = nano-sized architecture

Aerogel of silica



network of nanoparticles

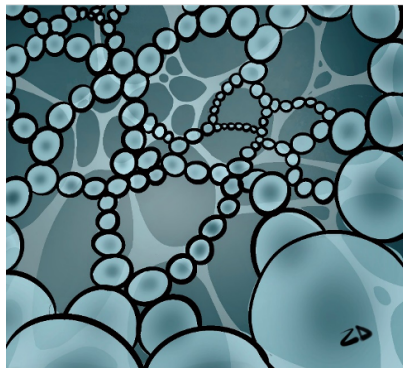

Material science strategy for gaz-solid mixing

bright and fast: an aerogel of **inorganic nanoscintillators** or MOF

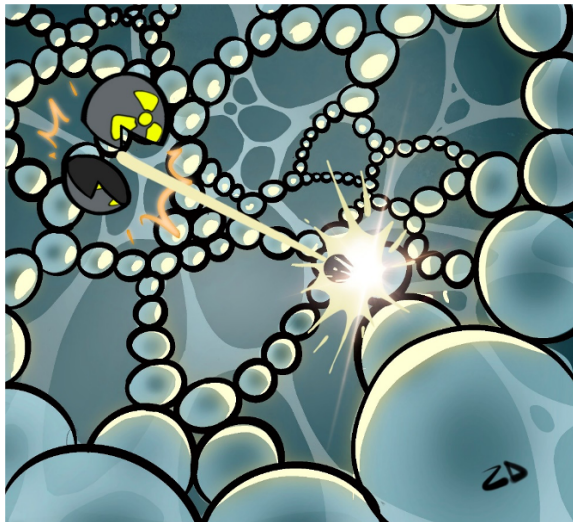

Material science strategy for gaz-solid mixing

The concept and target ($h \approx 5 \text{ cm}$, $\varnothing \approx 2.5 \text{ cm}$)

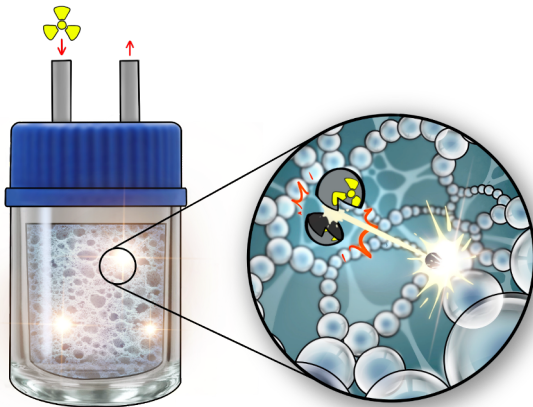

The H2020-FET-OPEN SPARTE project



- **University Lyon 1 - France**, Aerogel of inorganic scintillator, Scintillation, data analysis
- **Czech Technical University Czech Rep.**, Nanoscintillator with photochemical synthesis
- **Milano Bicocca University, Italy**, MOF nanocrystals, Scintillation
- **Materias srl, Italy**, MOF based aerogel synthesis
- **CEA, France**, MOF crystals, Radioactive gas analysis
- **Lyon Ingenierie Projet, France**, Project administration



This project has received funding from the European Union's Horizon 2020 research and innovation programme under grant agreement No 899293

With MOF

nature photonics 

Article <https://doi.org/10.1038/s41566-023-01211-2>

Efficient radioactive gas detection by scintillating porous metal–organic frameworks

Received: 15 November 2022
Accepted: 7 April 2023
Published online: 18 May 2023

Check for updates

Matteo Orfano^{1,5}, Jacopo Perego^{1,5}, Francesca Cova¹,
Charl X. Bezuidenhout¹, Sergio Piva¹, Christophe Dujardin²,
Benoit Sabot³, Sylvie Pierre², Pavlo Mai², Christophe Daniel⁴,
Silvia Bracco¹, Anna Vedda^{1,5}, Angiolina Comotti^{1,5} &
Angelo Monguzzi^{1,5}

RESEARCH ARTICLE ADVANCED
FUNCTIONAL
MATERIALS
www.afm-journal.de

Detection of Radioactive Gas with Scintillating MOFs

Sharvane Mauree, Vincent Villemot, Matthieu Hamel, Benoit Sabot, Sylvie Pierre, Christophe Dujardin, Francesca Belloni, Angiolina Comotti, Silvia Bracco, Jacopo Perego, and Guillaume H. V. Bertrand*

It performs well as building block: bright and fast (organic dyes)
but hard to get a transparent monolith yet.

Aerogel of inorganic nanoscintillator

It exists many compositions satisfying the needs:

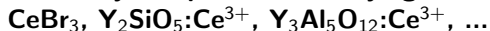

but:

- It requires to prepare a large porous aerogel (a few cm)
- Chemical stability
- Radiopure (no Lu)
- With properties as nanosize preserved
- We do not care about density of the compound

→ based on our experience, we have selected $\text{Y}_3\text{Al}_5\text{O}_{12}:\text{Ce}^{3\text{or}4+}$



From Nanoparticle Assembly to Monolithic Aerogels of YAG, Rare Earth Fluorides, and Composites

Mateusz Odziomek,^{†,‡} Frederic Chaput,^{§,¶} Frederic Lerouge,[†] Christophe Dujardin,^{§,¶} Maciej Sitarz,[‡] Szilvia Karpati,[†] and Stephane Parola^{¶,†}

Aerogel of YAG:Ce⁴⁺

From a lab sample to a functional sensor (with YAG:Ce⁴⁺)

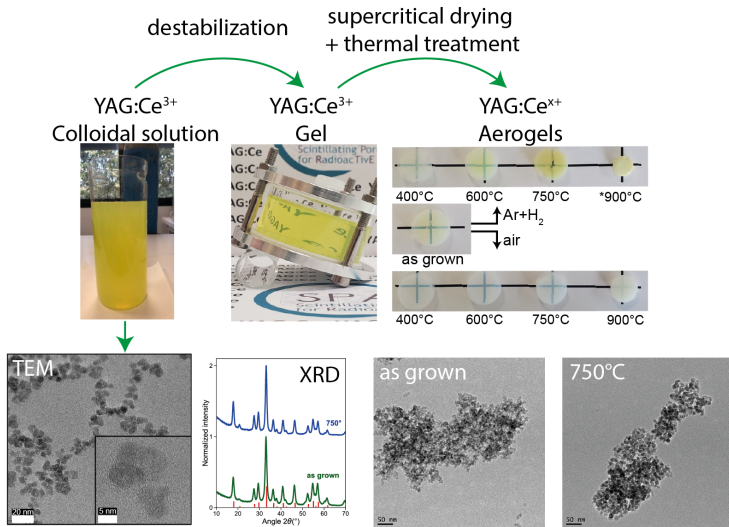

→ The best sample is 750°C in air

The Scintillation of the YAG:Ce⁴⁺ aerogel

→ **4+ is not a typo**: we are dealing with scintillation!
Ce⁴⁺ can be seen as a "pre-prepared" Ce³⁺ + 1 captured hole.

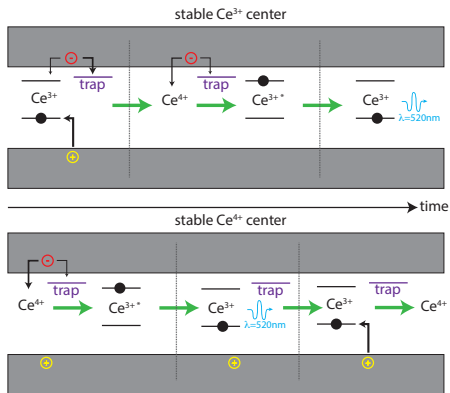

See

- Blahuta et. al. IEEE-TNS2013 for LYSO:Ce
- Nikl et. al. Cryst. Growth and Des. 2014 with LuAG:Ce
- Dujardin et.al. IEEE-TNS 2018 as a review

The selected YAG:Ce⁴⁺ aerogel sample

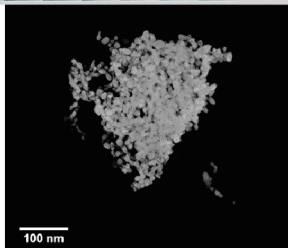
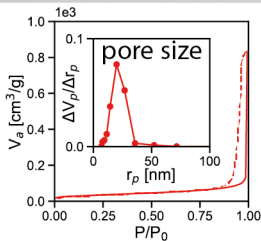

The Scintillation of the YAG:Ce⁴⁺ aerogel

Radioluminescence spectra and time response under X-rays

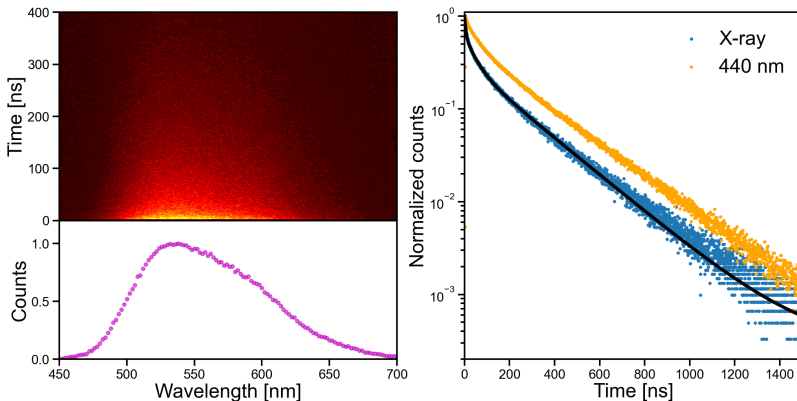

Standard RL spectra for YAG:Ce⁴⁺

Slower decay due to the low refractive index

$d \approx 0.36 \text{ g.cm}^{-3}$ (crystal $d=4.56 \text{ g.cm}^{-3}$) → **92% of air, 8% of YAG**

Measuring the yield of aerogel

3 PMTs: Double and triple coincidence technique

A scintillation event \rightarrow several optical photons

- for this scheme each pulse corresponds to a single **optical** photon

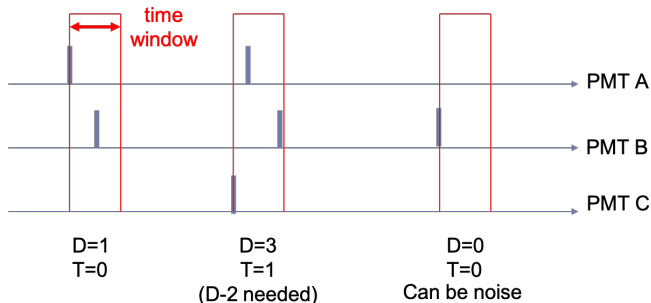

$\rightarrow D=1$: 1 scintillation event $\rightarrow D$ gives the activity

$\rightarrow T/D$ gives the scintillation yield

According to Poisson distribution $n_{pe} \approx -3 \ln(1 - \frac{T}{D})$

Measuring the yield of aerogel

The Compton TDCR experiment

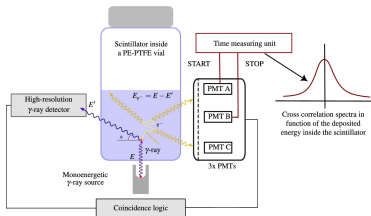
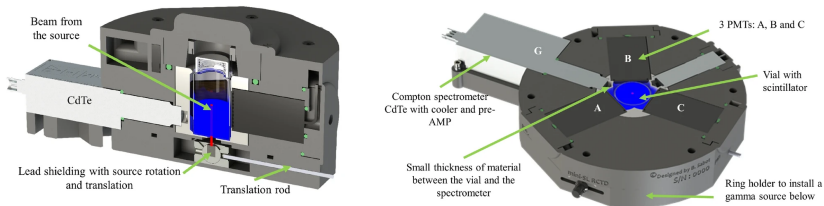

→ It allows to know the yield at known electron energy

see: Sabot B.. 2024, Scientific Report 14, 6960

Measuring the yield of aerogel

Efficiency under electron excitation

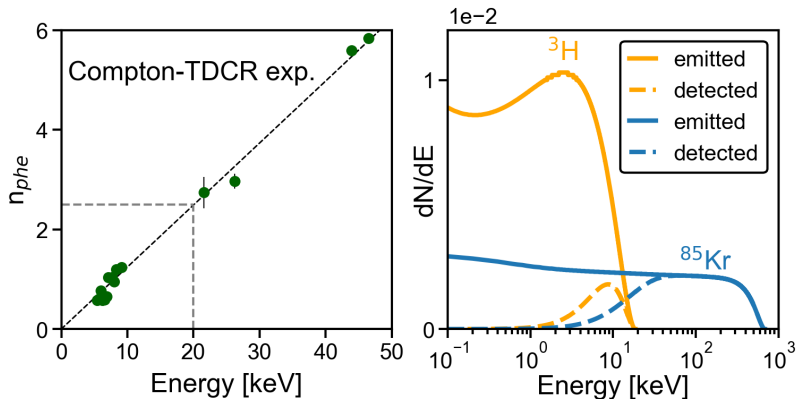

Compton-TDCR \rightarrow **0.124 phe/keV**

0.124 phe /keV \rightarrow detection efficiency prediction:

96.3% for ^{85}Kr and 17.6% for 3H

The Experiment under radioactive Gaz

The detection module with 3 PMTs developed for Liquid Scintillation at CEA-LNHB

→ Double and triple coincidences technique

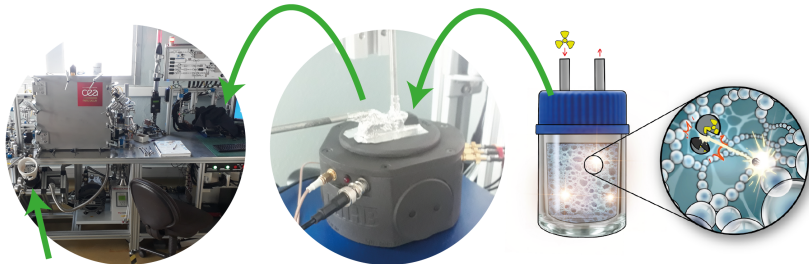

The radioactive gas

3 aerogel pieces in the liquid scintillation vial were used.

The results with ^{85}Kr

Analysis in 100s per point (almost real time)

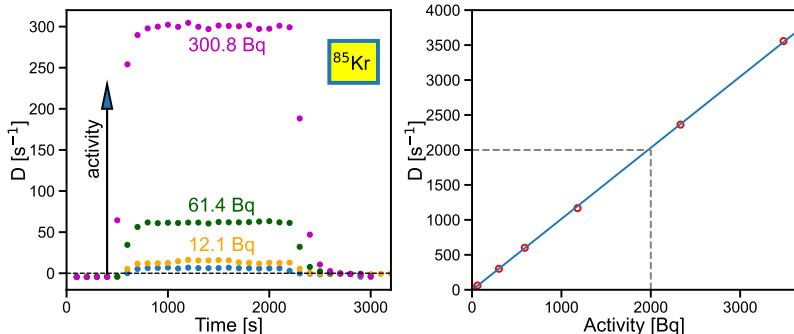

Very good linearity for ^{85}Kr and 100% of detection efficiency !
(96.3% was predicted)

The results with ^3H

Analysis in 100s per point (almost real time)

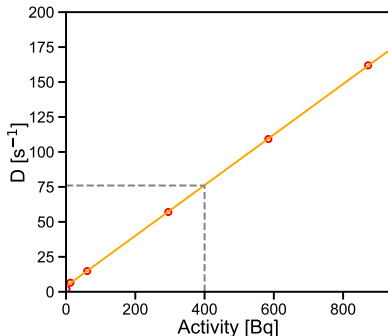
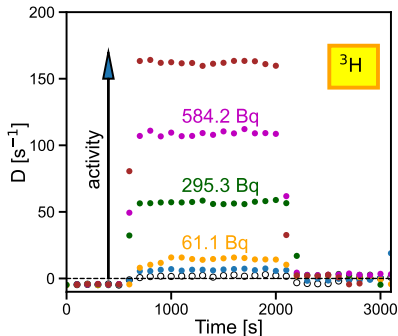

Very good linearity for ^3H and 18.1% of detection efficiency !
(17.6% was predicted)

Multiple measurements

And a good detection reproducibility

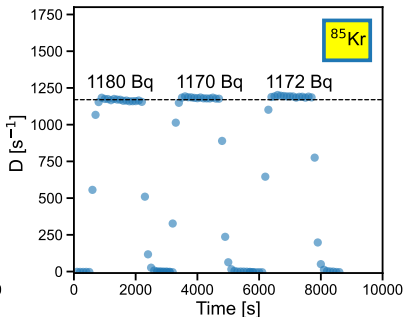
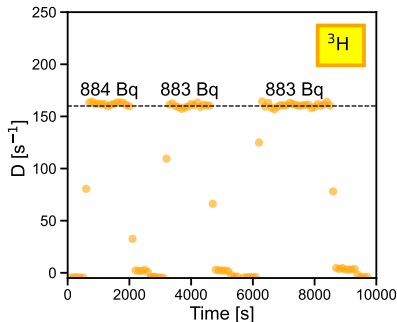

We can detect sub-Bq / cm^3 of ${}^{85}Kr$ & 3H in real time!

Current detection **sensitivity**: a few $10mBq/cm^3$ (atm. pressure)

About Time coincidence window

Experimental evolution of T/D as a function of Δt

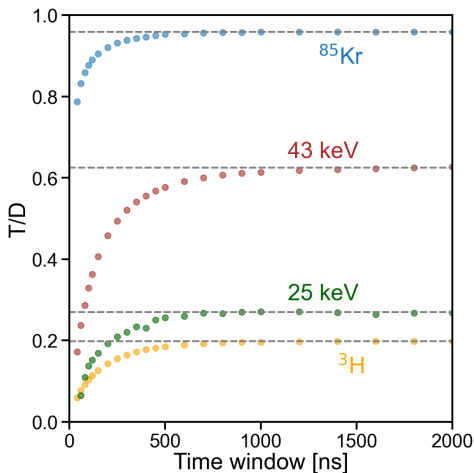

Can we simulate?

About Time coincidence window

The Monte Carlo method with the X-ray decay

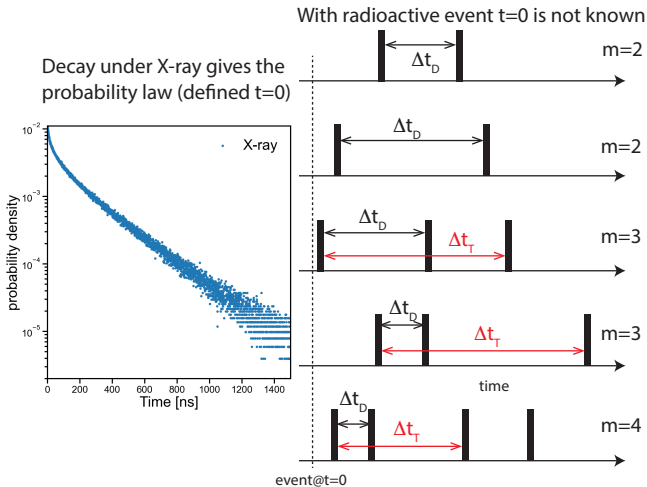

→ It allows to evaluate D and T vs Δt for various m .

About Time coincidence window

The Monte Carlo method to simulate T and D vs Δt

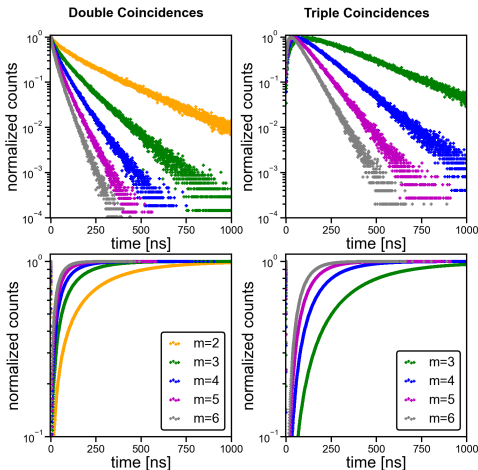

→ let's take a poisson distribution to get T/D vs Δt ?

About Time coincidence window

Experience & simulation of T/D vs Δt

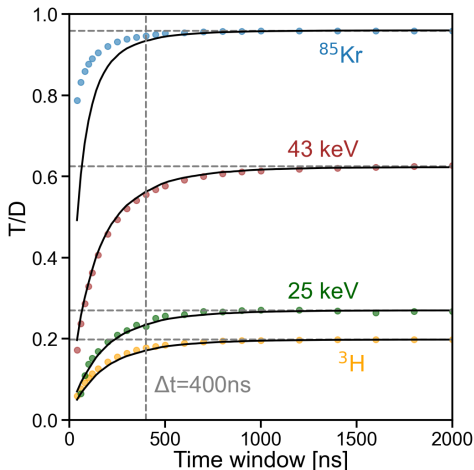

→ $\Delta t = 400$ ns is a good compromise: signal / noise

→ Cannot fit the ^{85}Kr because of the wide spectrum

Spectroscopic capability

Analysis of the ratio triple coinc. / double coinc.

(an indicator of the mean number of photons per event)

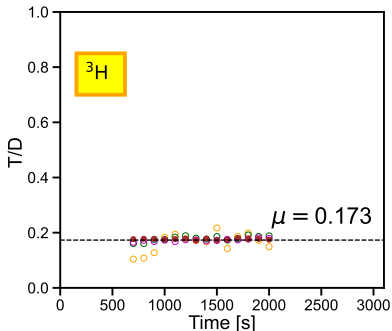
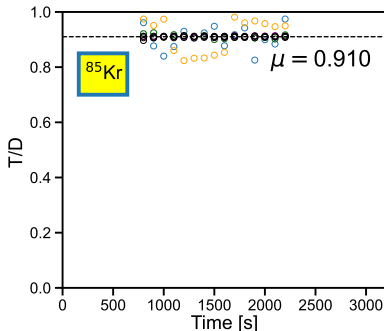

It reflects the higher mean energy of electrons for ^{85}Kr

→ It can be used for gas identification

Spectroscopic capability

A measure with 2 gaz mixtures ($^3\text{H} + ^{85}\text{Kr}$)

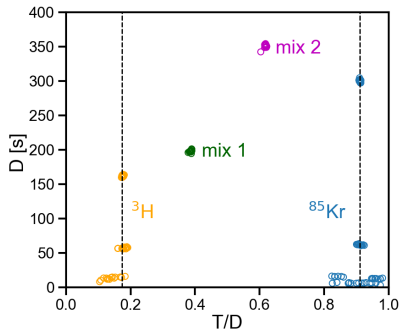
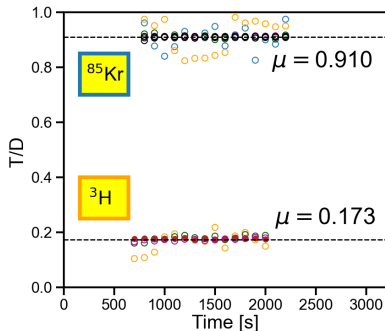

→ The mixtures can be identified !
(but requires a system with 3 detectors)

Spectroscopic capability

The same information considering **D** with 2 different time windows

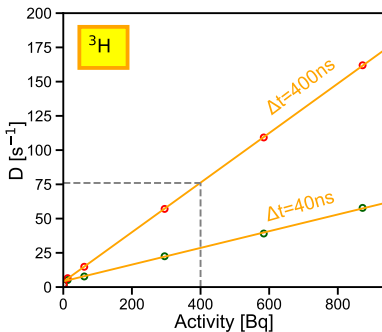
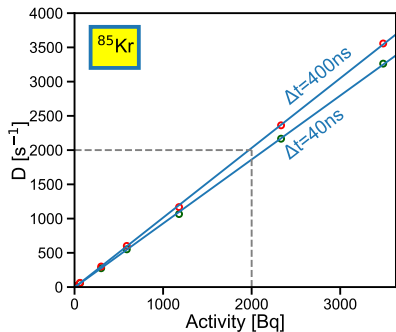

- large electron energy: almost no difference
- small electron energy: large difference

- It can be obtained with only 2 detectors!

Identification with the 2D map: Activity (D_{400}) vs D_{400}/D_{40}

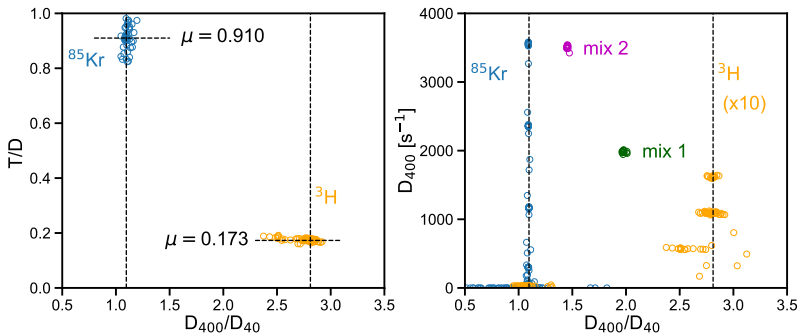

→ It allows to check the "purity" of the gases as well !

→ Measurement with the same gas mixtures ($^{85}\text{Kr} + ^3\text{H}$)

Spectroscopic capability

Example of measurements with the 2 gas mixtures ($^{85}\text{Kr} + ^3\text{H}$)

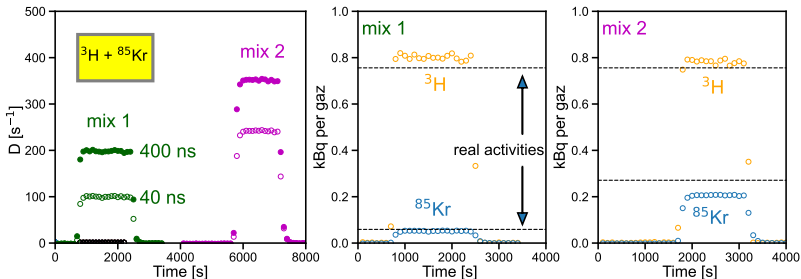

We can combine the 2 informations to "demix" the respective activities

→ Almost real time information (100 s per point)

- Patent 2307880 (July 2023) -

→ Crucial information for nuclear power plants during operation



Thank you for your attention

(R.Marie-Luce et al, under revision)

follow our project: <https://www.sparte-project.eu>



This project has received funding from the European Union's Horizon 2020 research and innovation programme under grant agreement No 899293