



**HAL**  
open science

## Long-duration plasma operation in WEST

R Dumont, T Fonghetti, P Maget, P Manas, C Bourdelle, J Morales, K Afonin, T Barbui, G Ciraolo, Y Corre, et al.

► **To cite this version:**

R Dumont, T Fonghetti, P Maget, P Manas, C Bourdelle, et al.. Long-duration plasma operation in WEST. 66th Annual Meeting of the APS Division of Plasma Physics, Oct 2024, Atlanta, United States. cea-04914314

**HAL Id: cea-04914314**

**<https://cea.hal.science/cea-04914314v1>**

Submitted on 27 Jan 2025

**HAL** is a multi-disciplinary open access archive for the deposit and dissemination of scientific research documents, whether they are published or not. The documents may come from teaching and research institutions in France or abroad, or from public or private research centers.

L'archive ouverte pluridisciplinaire **HAL**, est destinée au dépôt et à la diffusion de documents scientifiques de niveau recherche, publiés ou non, émanant des établissements d'enseignement et de recherche français ou étrangers, des laboratoires publics ou privés.



# Long-duration plasma operation in WEST

R. Dumont, on behalf of the WEST team\*  
CEA, IRFM, F-13108 Saint Paul-lez-Durance, France

\* see <http://west.cea.fr/WESTteam>

Special thanks to:

T. Fonghetti, P. Maget, P. Manas, C. Bourdelle, J. Morales, K. Afonin,  
T. Barbui, G. Ciralo, Y. Corre, L. F. Delgado-Aparicio, J. Dominski,  
A. Ekedahl, N. Fedorczak, A. Gallo, J. Gaspar, C. Guillemaut, J. Hillairet,  
E. Lerche, X. Litaudon, R. A. Lunsford, D. Mazon, D. Moiraf, Ph. Moreau,  
R. Nouailletas, C. Reux, N. Rivals, Y. Savoye-Peysson, E. Tsitrone, T. Wauters

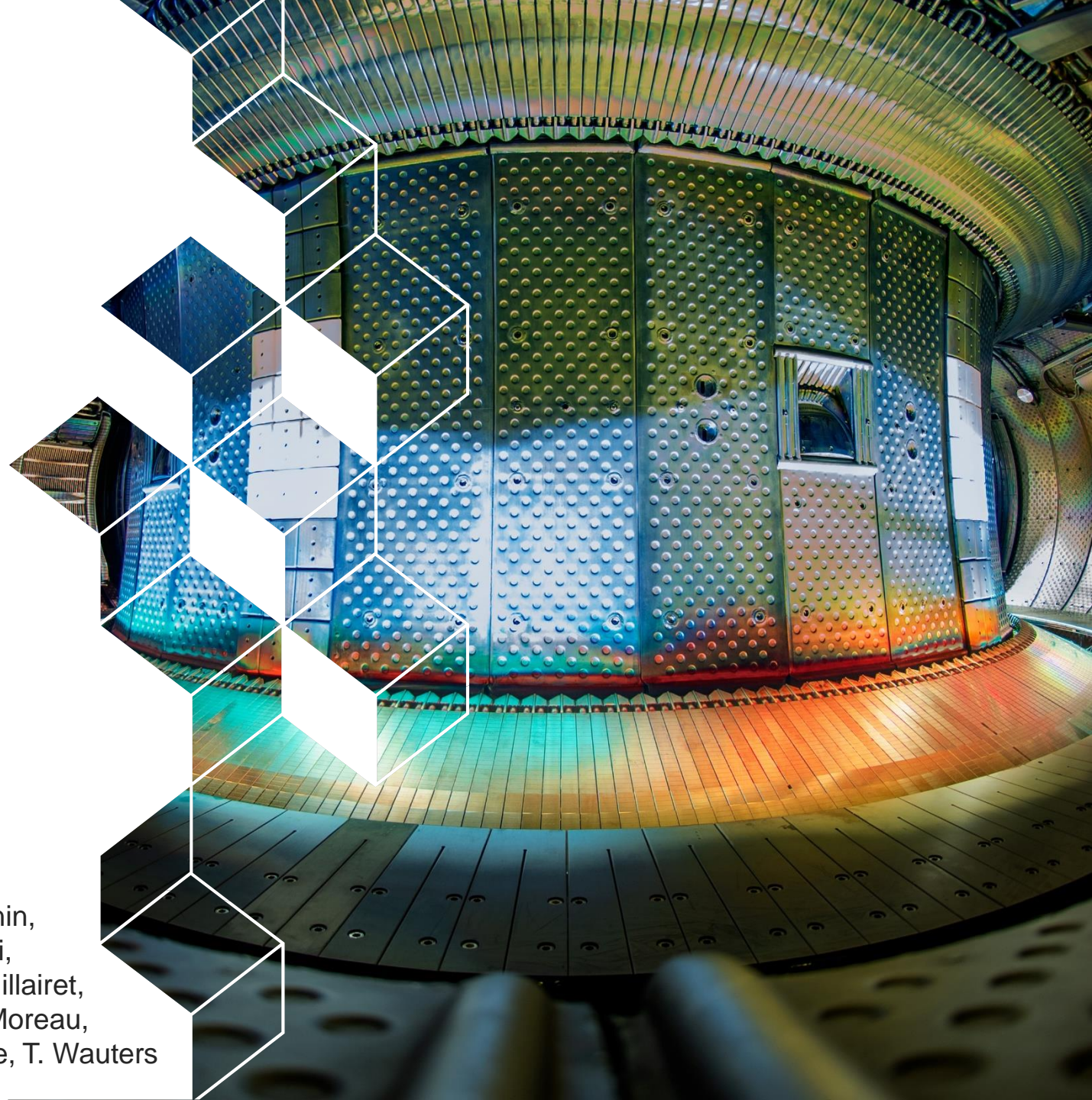

# Long Pulse Operation (LPO): a definition

[CICLOP group, NF 2024]



- Plasma with durations well above the plasma confinement time, approaching plasma-wall integration timescales
  - ITER 100-400s H-mode regime belongs to the LPO category

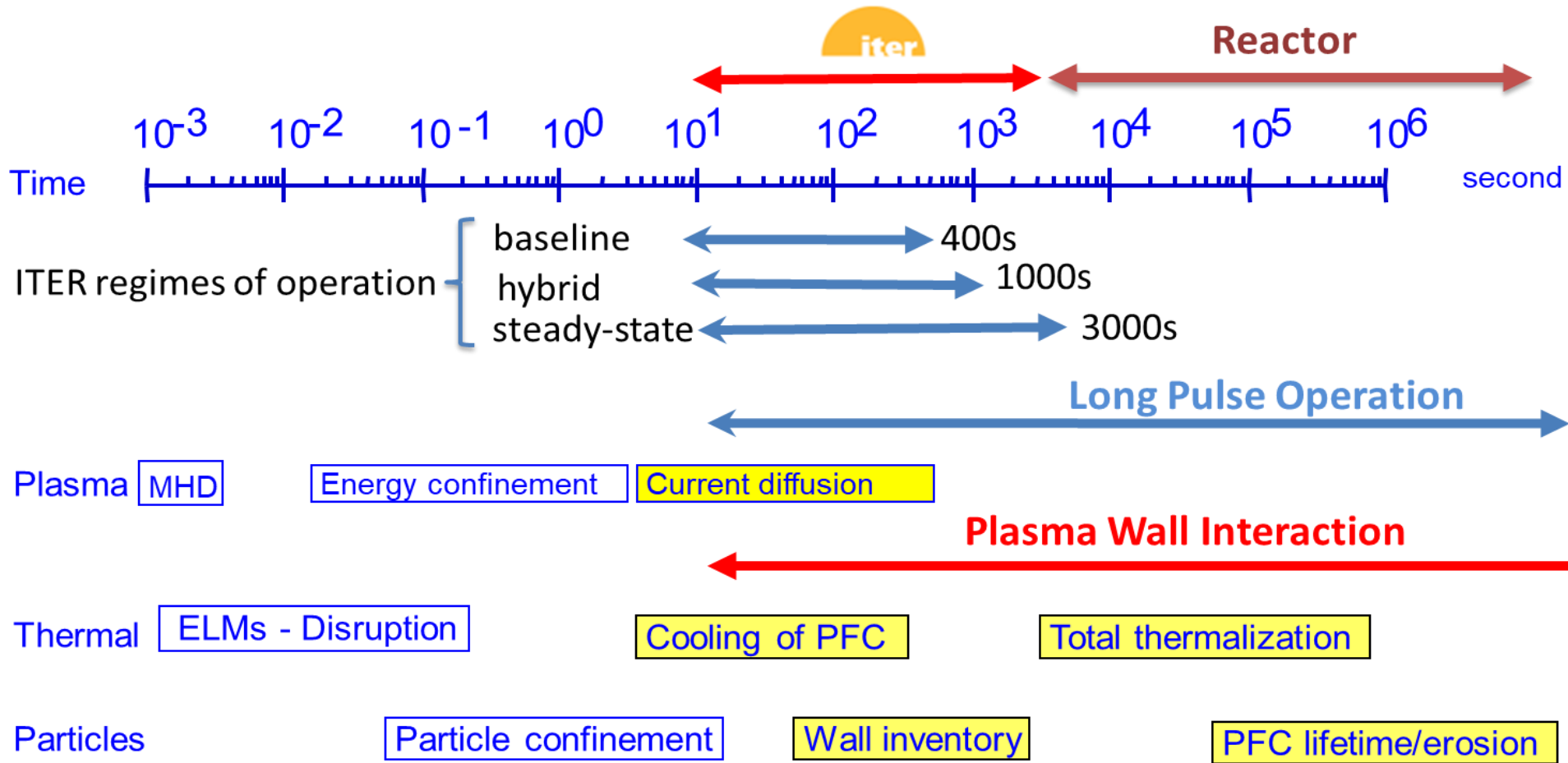

## Operational limits ?

- Limit in available flux
- PFC Limits (e.g. temperature, flux  $10\text{MW/m}^2$ )
- Flaking/dust





# WEST: a testbed for tungsten-related aspects of ITER preparation

- Long Pulse capability, dominant electron heating, no external momentum source

[Bucalossi, NF 2024]

- Superconducting magnets, nominal magn. field 3.7 T
- LHCD power up to 7 MW – 1000 s
- ICRH power up to 9 MW
- *ECRH 1 MW (2024), 3 MW from 2025*
- Lower/Upper X-point, Double-Null configurations

- Tungsten environment

- Actively cooled ITER-grade tungsten divertor
- Inner / outer bumpers
  - W coated until mid-2020,
  - BN at mid-plane until spring 2024,
  - *Bulk W from autumn 2024*

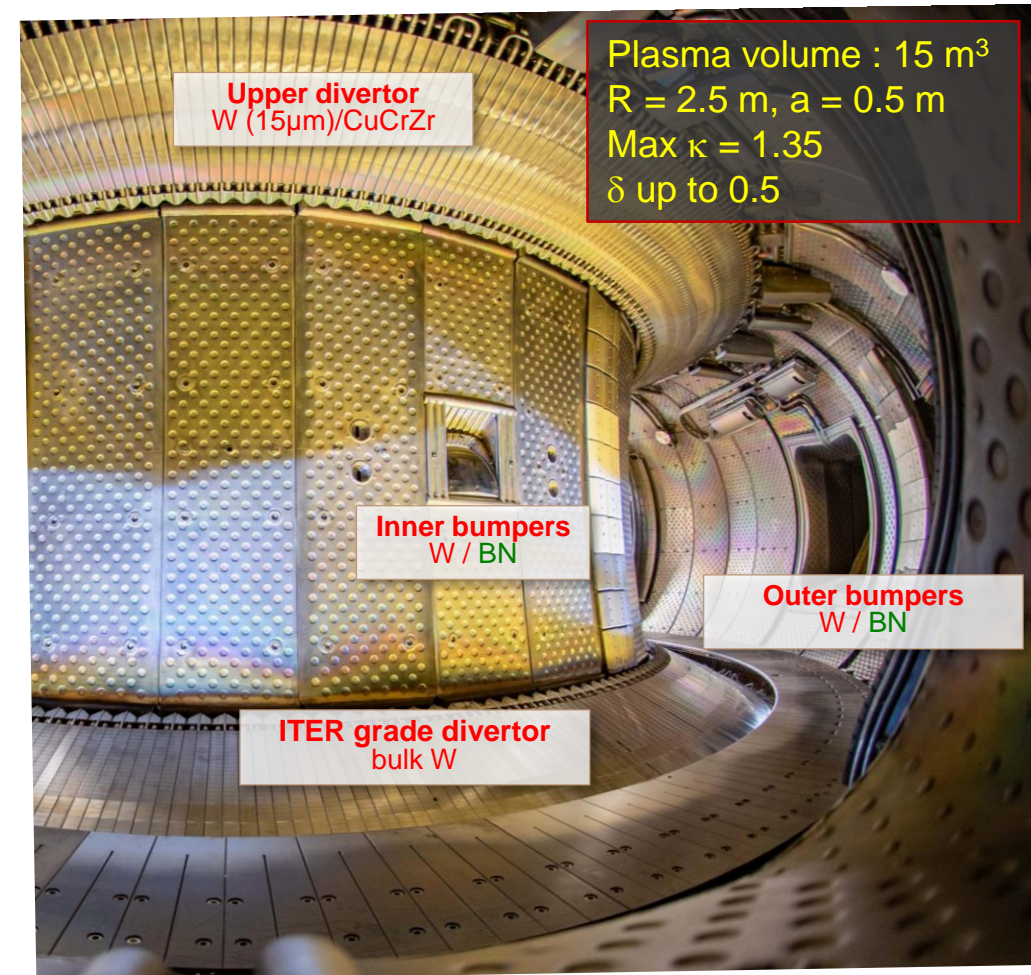

# Outline

- 1. Long pulse scenario development based on integrated modelling**
- 2. Challenge #1: outgassing**
- 3. Challenge #2: UFOs**
- 4. Outlook: EC power**





# **1 ■ Long pulse scenario development based on integrated modelling**

# LHCD physics determines key parameters for non-inductive current maximization

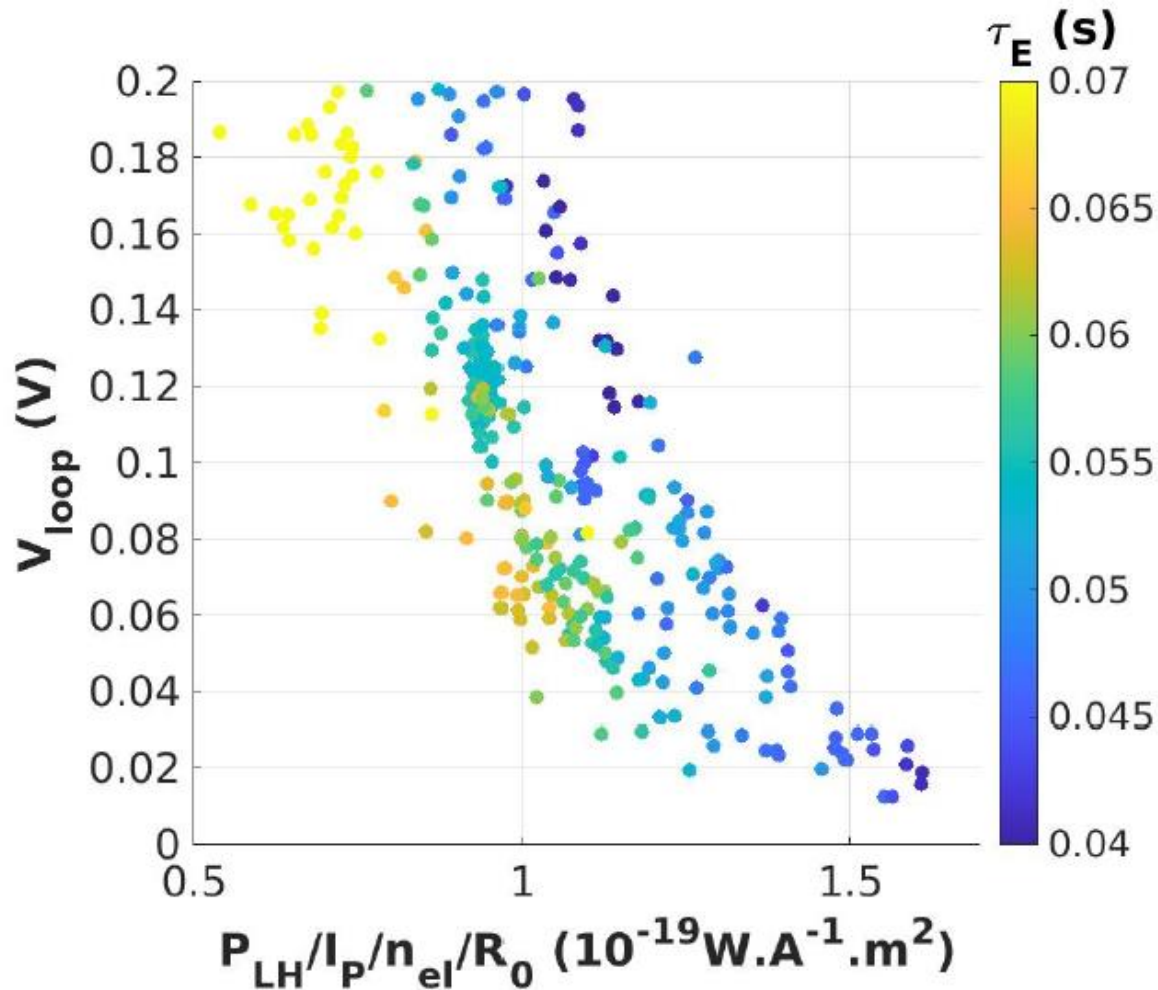

- Loop voltage drop when LH power is applied

$$-\frac{\Delta V}{V_\Omega} = f_{bs} + \eta_{LH} \frac{P_{LH}}{\bar{n}_e R I_p}$$

- LHCD efficiency (fit)

$$\eta_{LH} = 2.37 \times 10^{19} D^{0.3} Z_{eff}^{-0.12} \tau_E^{0.4}$$

[Goniche, AIP proc. 2005]

[Fonghetti, in preparation]

- Fraction of current driven by LH waves

$$\frac{I_{LH}}{I_P} \propto \frac{P_{LH}}{\bar{n}_e R I_p} \tau_E^{0.4}$$

# Steady progress towards long pulses in recent WEST campaigns

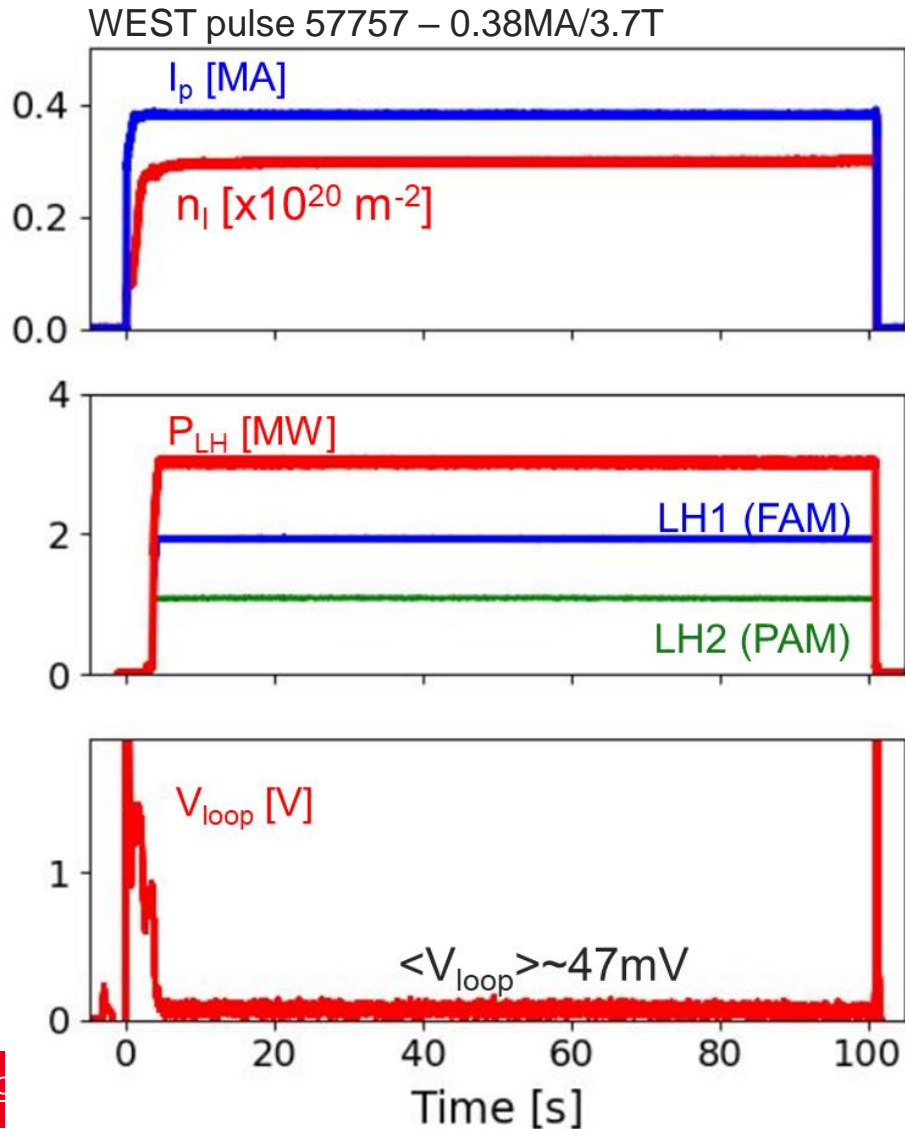

- Tore Supra LHCD efficiencies recovered, consistently with LUKE predicting no significant influence of W impurities on LHCD [Peysson, IAEA 2020]
- 02/2023: WEST pulse 57757 achieved  $V_{loop} \sim 47 \text{ mV}$  during 101s with 3MW LH power (E~290MJ) - Termination related to cooling pipe temperature interlock  
→ used as **reference pulse** for further developments

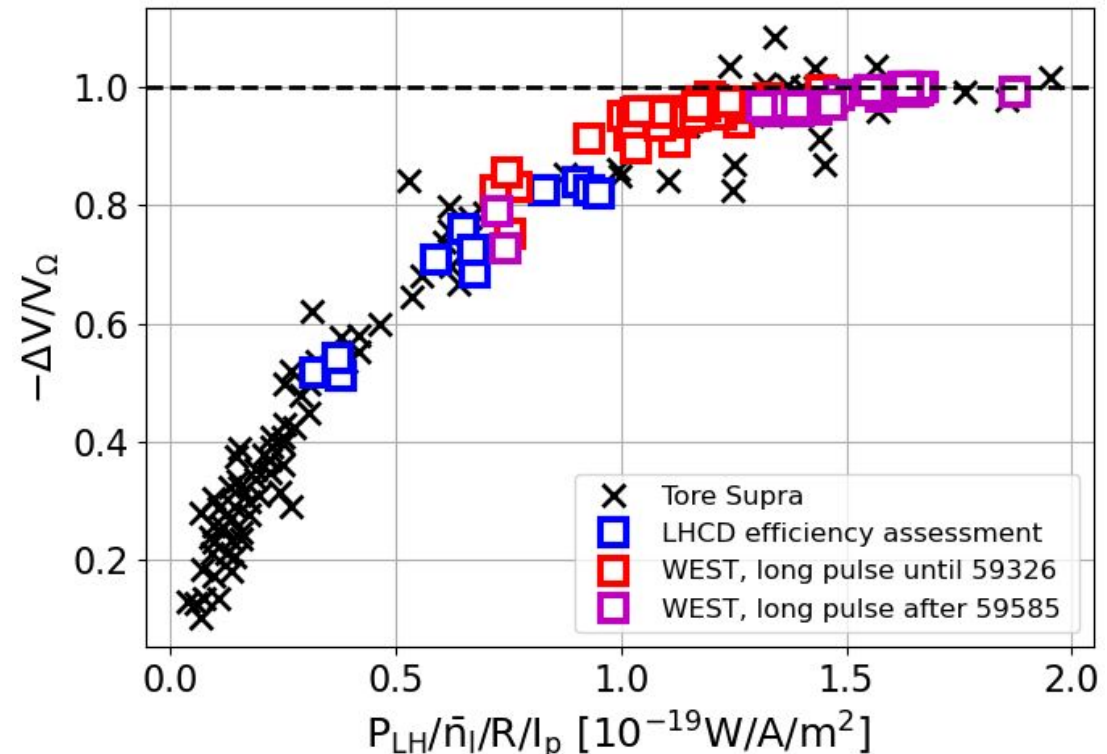



# Reference pulse interpretation requires combined description of heat source and transport

- High Fidelity Pulse Simulator (HFPS) based on JINTRAC/JETTO employed  EUROfusion
- Simplified model used for LHCD deposition profile [Dumont, PoP 2000], with experimental scaling law for current drive efficiency:  $\eta_{\text{LH}} \propto \tau_{\text{E}}^{0.4}$  [Goniche, AIP proc. 2005]
- TGLF-sat2 model for turbulent transport [Staebler, PPCF 2020; Angioni, NF 2022]

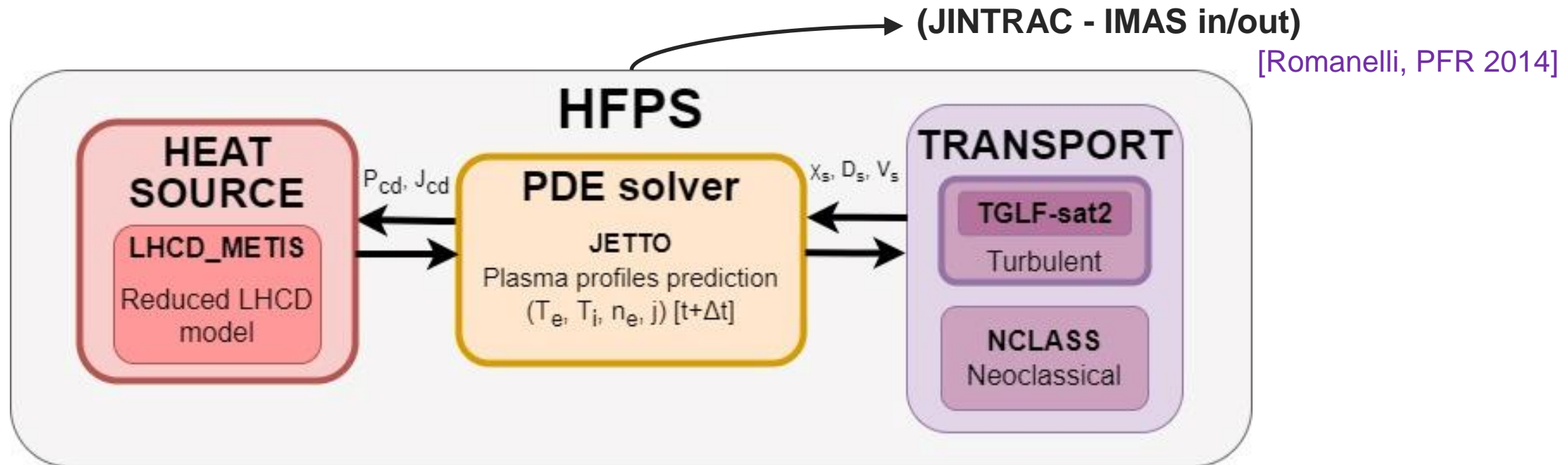

# Integrated modelling allows plasma measurements to be recovered

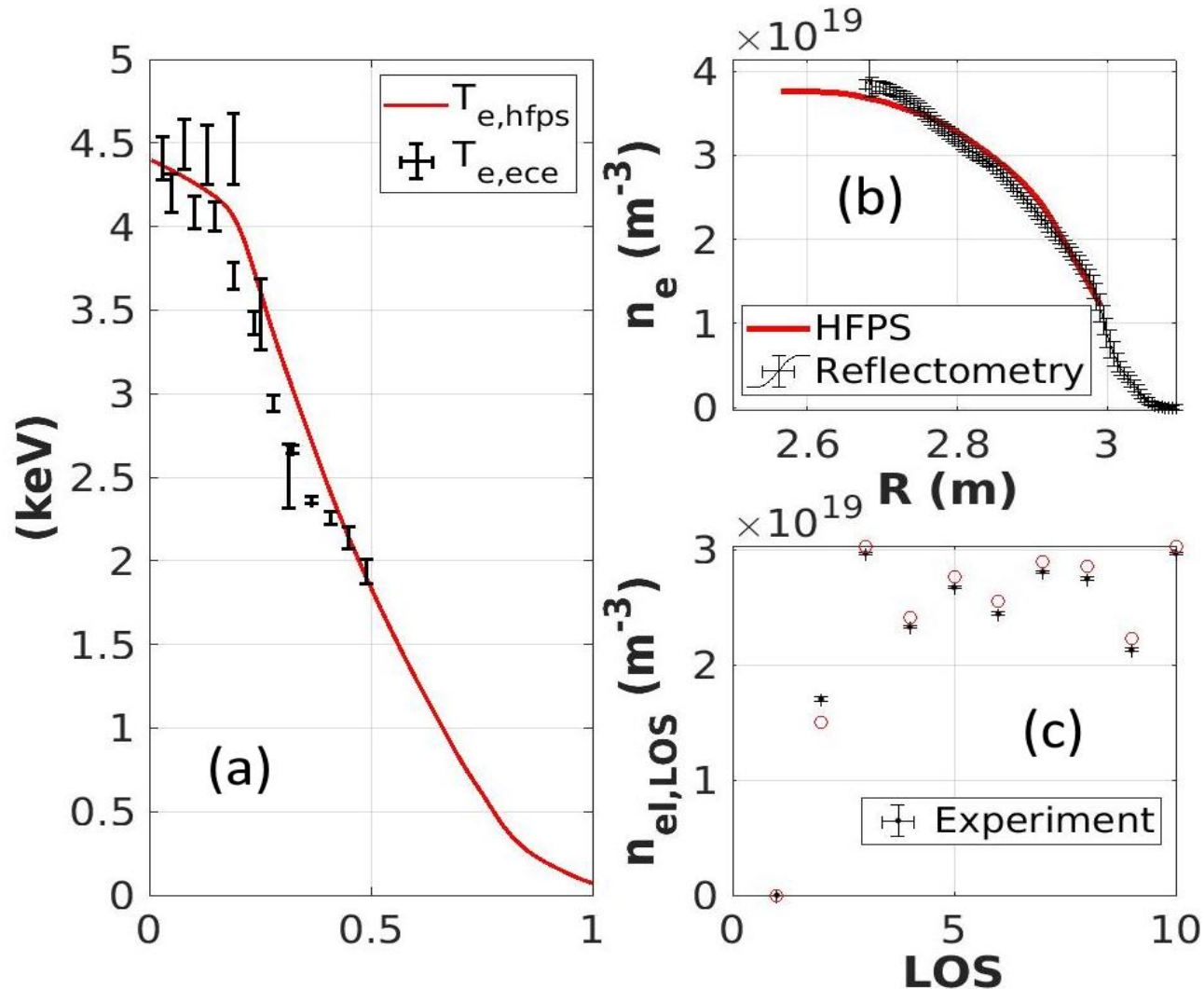

- Electron density and temperature profiles well described  $\rightarrow$  energy content recovered
- Loop voltage recovered within 10mV error range
- Standard energy confinement time dependence with  $I_p$  recovered ( $\tau_E \propto I_p^{0.59}$  found)

$$\frac{I_{LH}}{I_P} \propto \frac{P_{LH}}{\bar{n}_e R I_p} \tau_E^{0.4} \propto \frac{1}{I_p^{0.76}}$$

- HFPS simulations predict fully non-inductive operation in reference pulse conditions (0.38MA) at  $I_p \sim 0.32\text{MA}$
- However, potential difficulties related to MHD stability to be expected as current is lowered

# Decreasing plasma current / increasing LH power promotes double tearing modes

- Experimental location of MHD crashes from ECE consistent with q-profile computed by HFPS - Here (3,2) mode destabilized

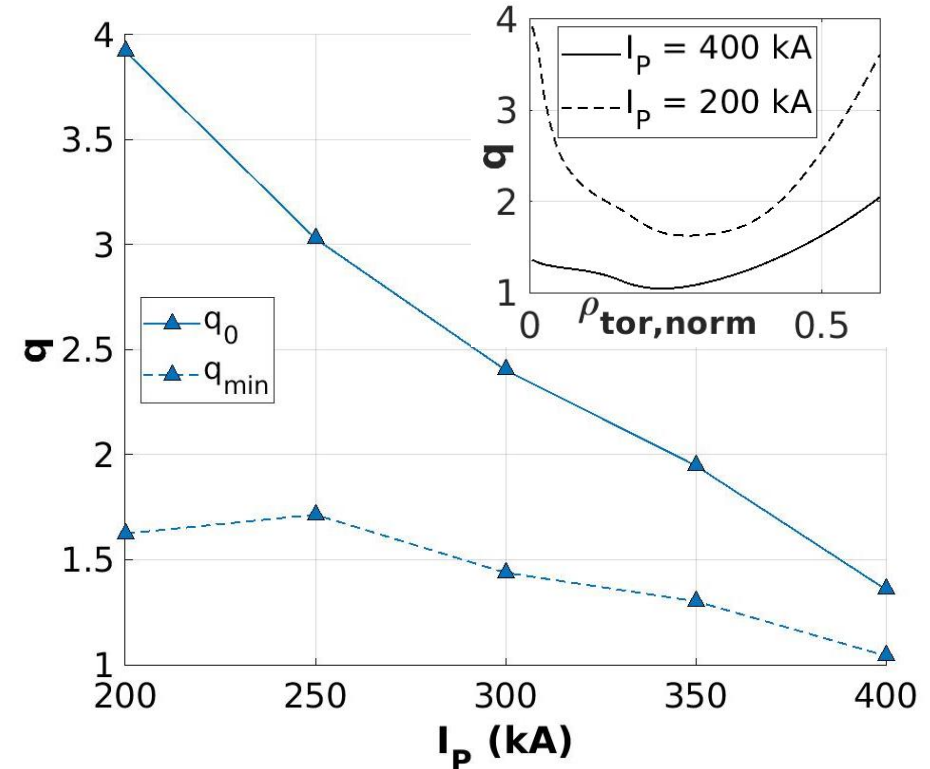
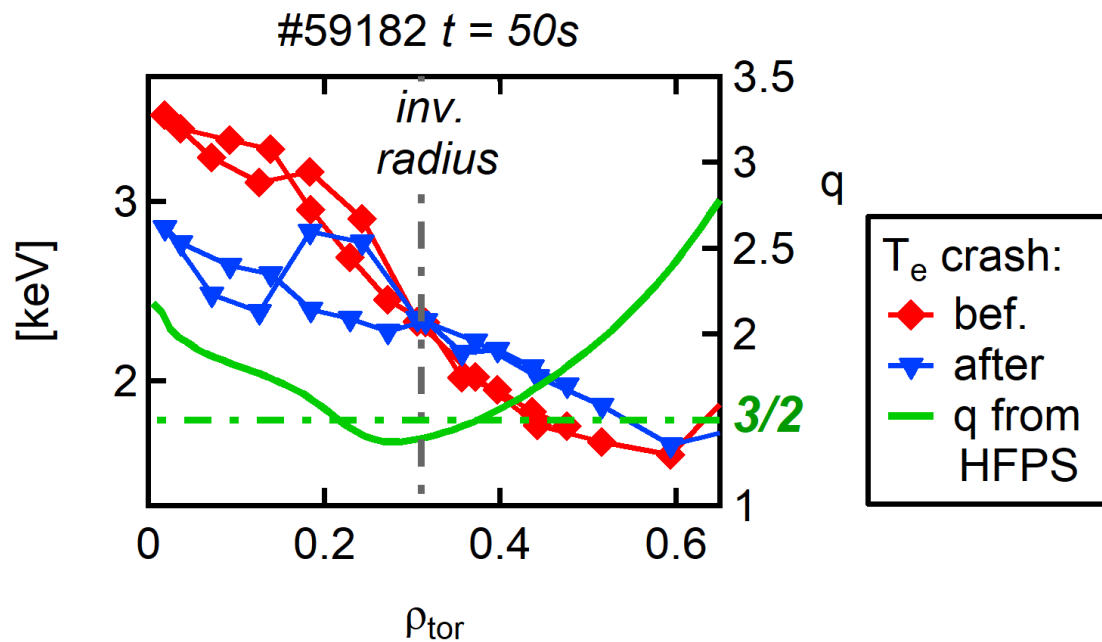

- q-profile reversal enhanced at lower current (and/or larger LH power)
- Self-consistent MHD stability module for HFPS currently under test

# Further predictive HFPS simulations allow parameter space to be identified

- Operational constraints:
  - Greenwald density limit
  - Upper cooling pipe temperature interlock, consistent with electron ripple loss dependences ( $T_{\max} [^{\circ}\text{C}] \sim 134 + 678 P_{\text{LH}} [\text{MW}]^{1.07} I_p [\text{MA}]^{0.58} n_{13} [10^{19} \text{m}^{-2}]^{-2.24}$ )
  - Occurrence of q-profile reversal minimized at lower  $P_{\text{LH}}$  and/or larger  $I_p$

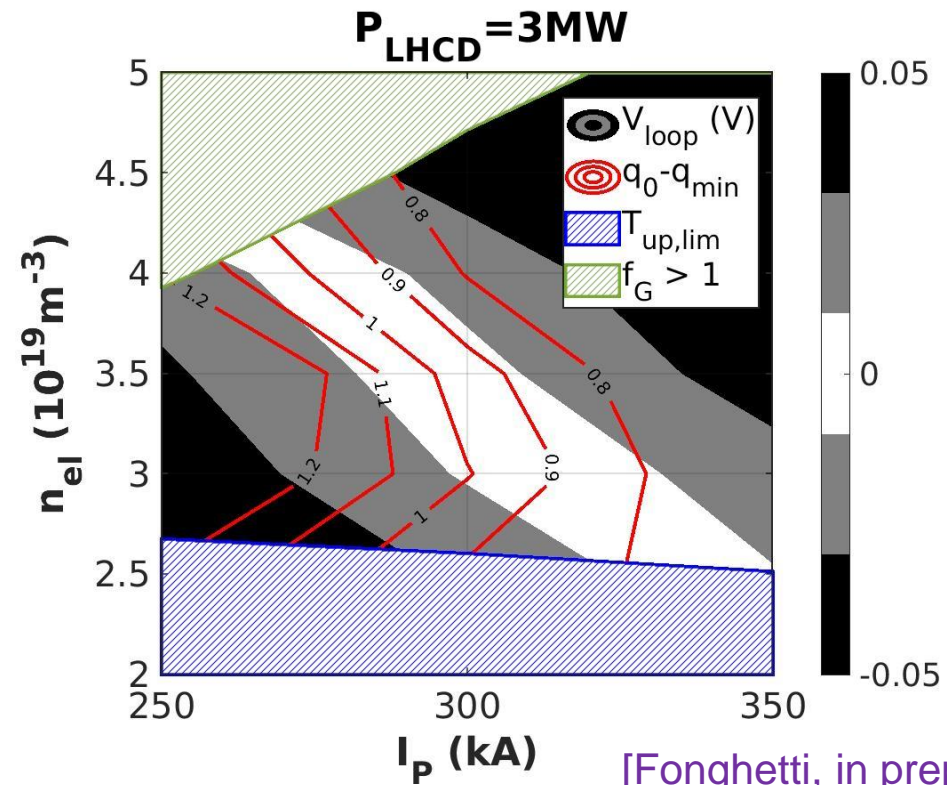
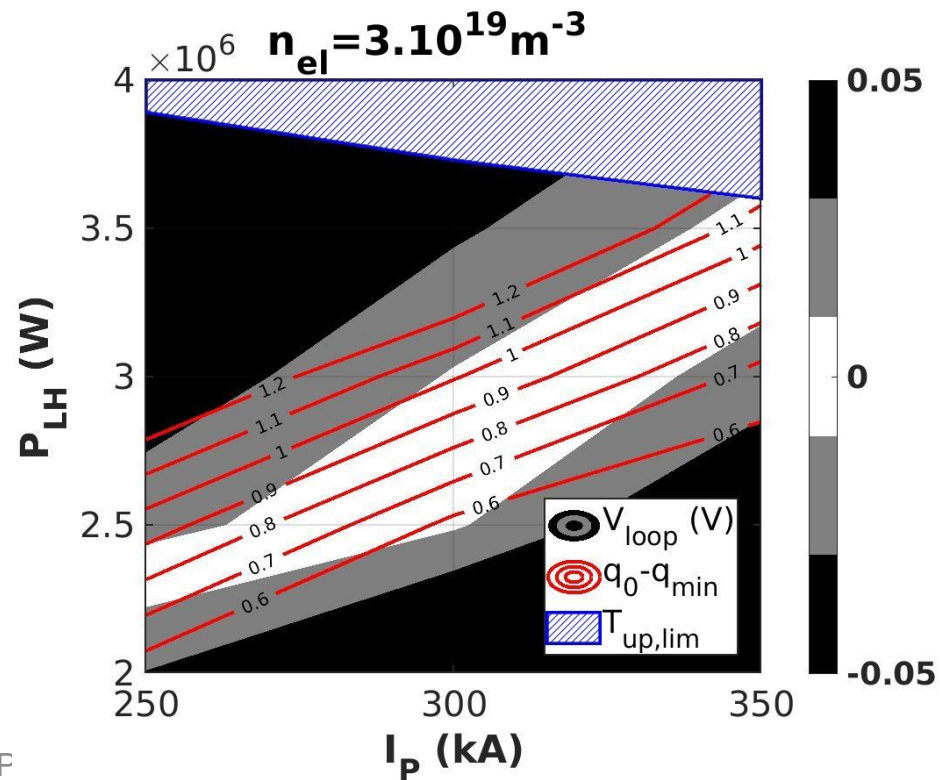



# New records achieved during latest campaign

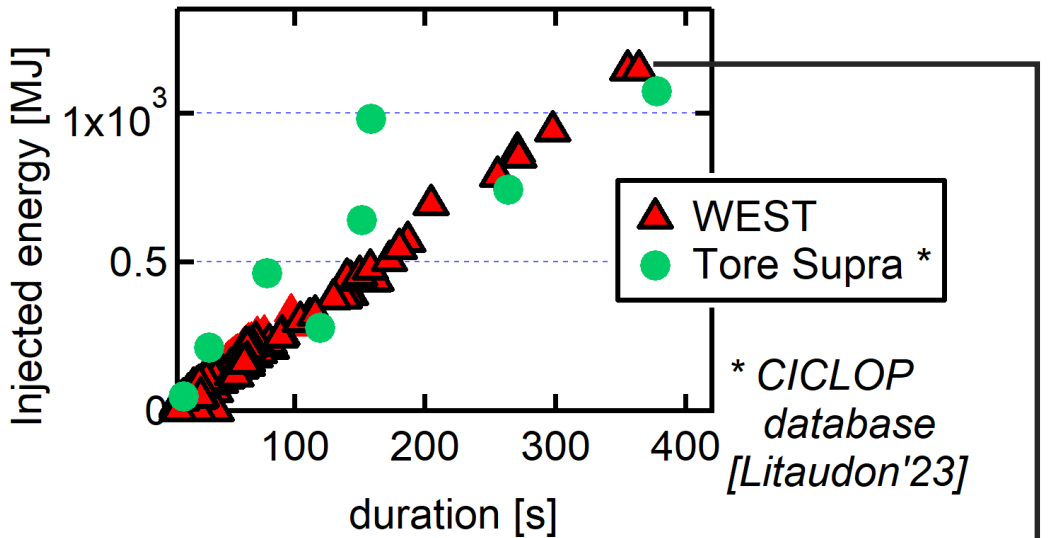

59763 - 0.27MA/3.7T

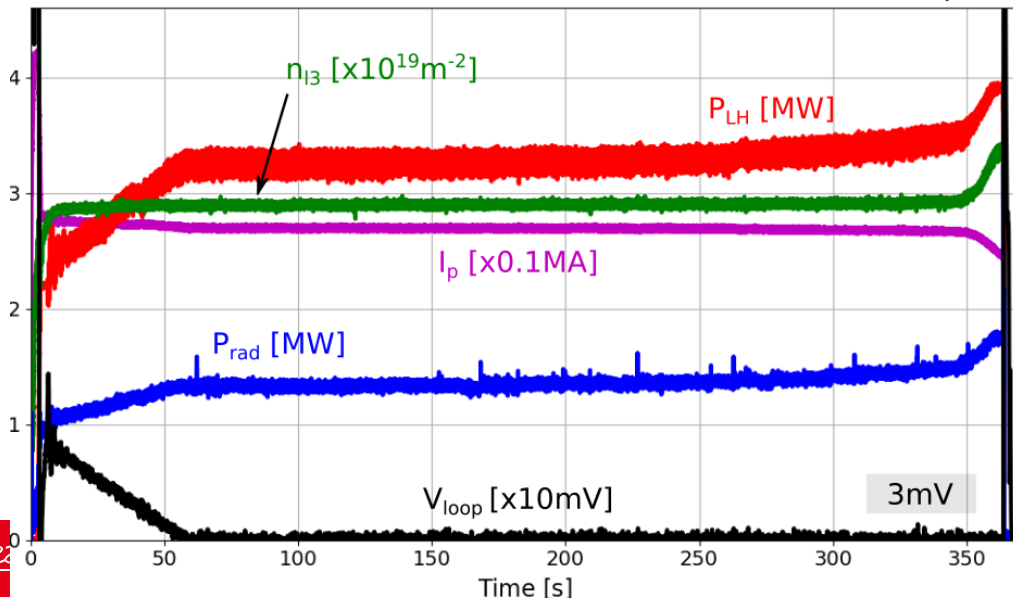

- **Pulse 59763**: new WEST duration & energy record
- **Duration: 364s**
- **Energy injected/extracted: 1.15GJ**  
(Overall energy record of WEST **and** Tore Supra!)
- Double feedback-control ( $V_{loop}$ ,  $V_{G0}$ ), ( $I_p$ ,  $P_{LH}$ )
- Plasma current 0.27MA
- LH power  $\sim 3\text{-}3.5\text{MW}$ , no ICRH
- Loop voltage: 3mV  $\rightarrow$  could in principle last  $>1100\text{s}$
- $H_{98,y2} \sim 1$ ,  $\beta_p \sim 1.6$ ,  $\beta_N \sim 0.7$
- No particular issue related to tungsten contamination
- **Several UFOs seen**, with no lasting consequences
- **Increase of density** at  $\sim 300\text{s}$ , caused by **outgassing** of remote elements in vacuum vessel  
 $\rightarrow I_p$  could not be maintained despite increase of LH power by feedback control system

# New multi-energy (ME) x-ray cameras operated @ WEST as part of US (DOE) & French (CEA) collaboration

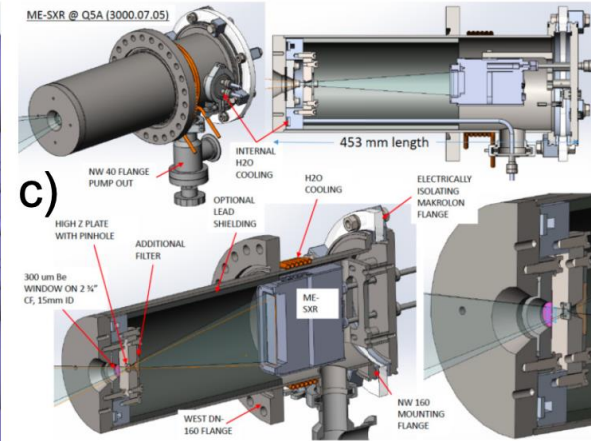
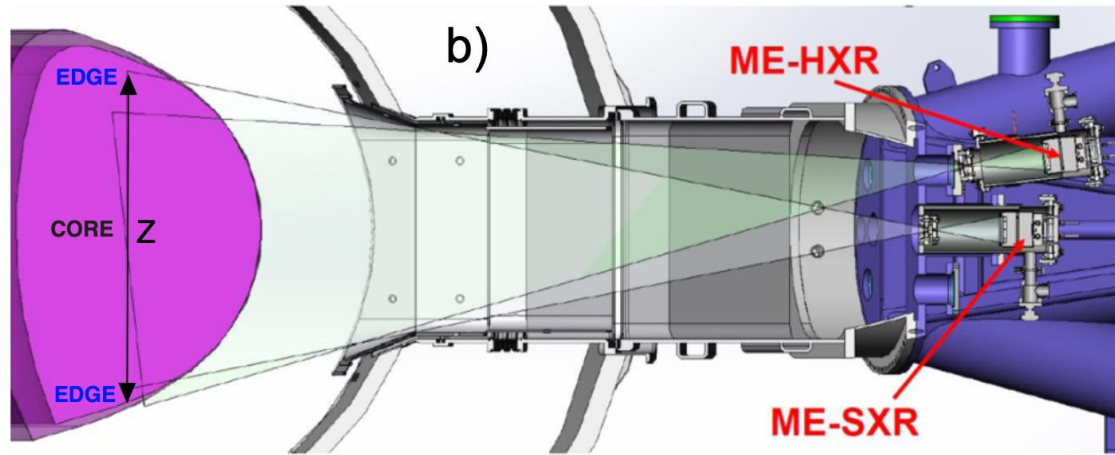
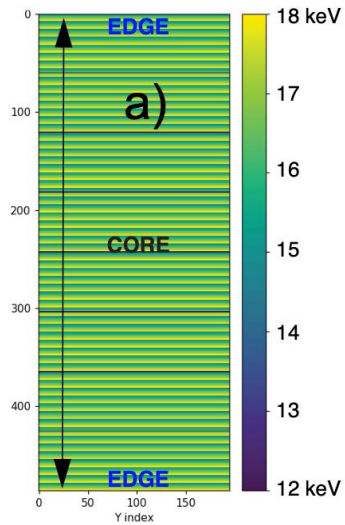

Multi-energy systems use *smart pixel technology* to disentangle  $n_W$  and  $T_e$ -effects in spatially recorded spectra

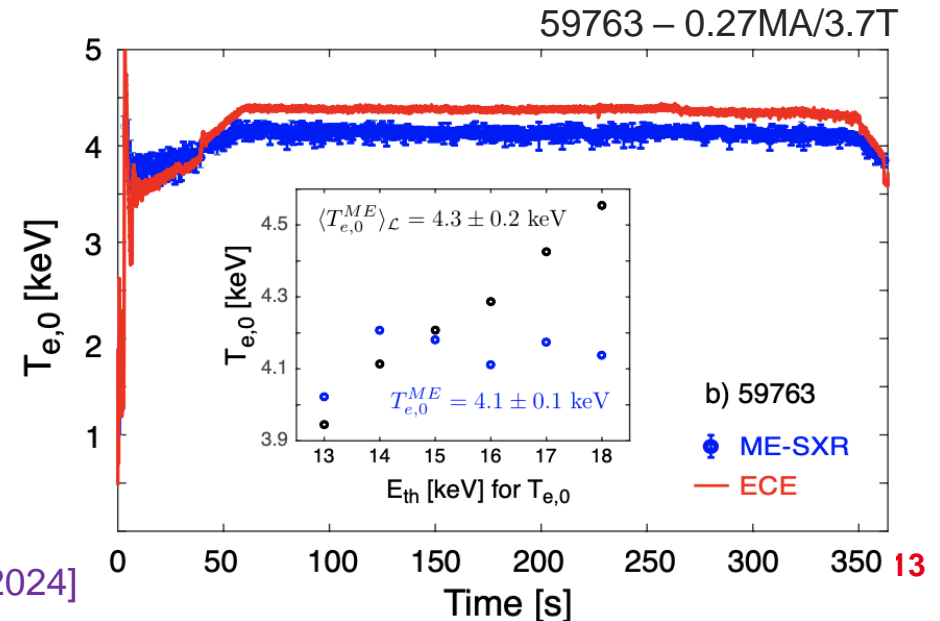



# 2 ■ Challenge #1: outgassing

# Longest duration pulses display outgassing

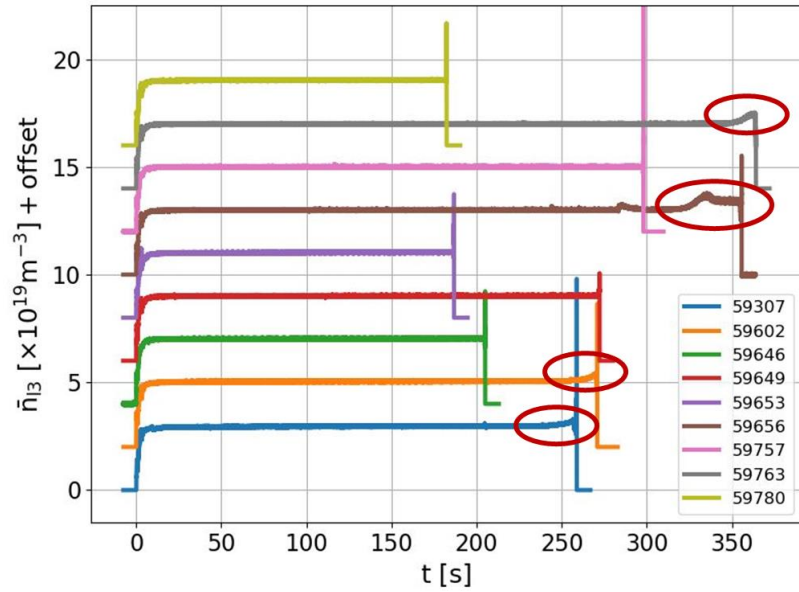

- Outgassing observed, probably related to remote elements in vacuum vessel
- Occurs at energies reaching  $\sim 1$ -1.2GJ
- Slow conditioning effect observed

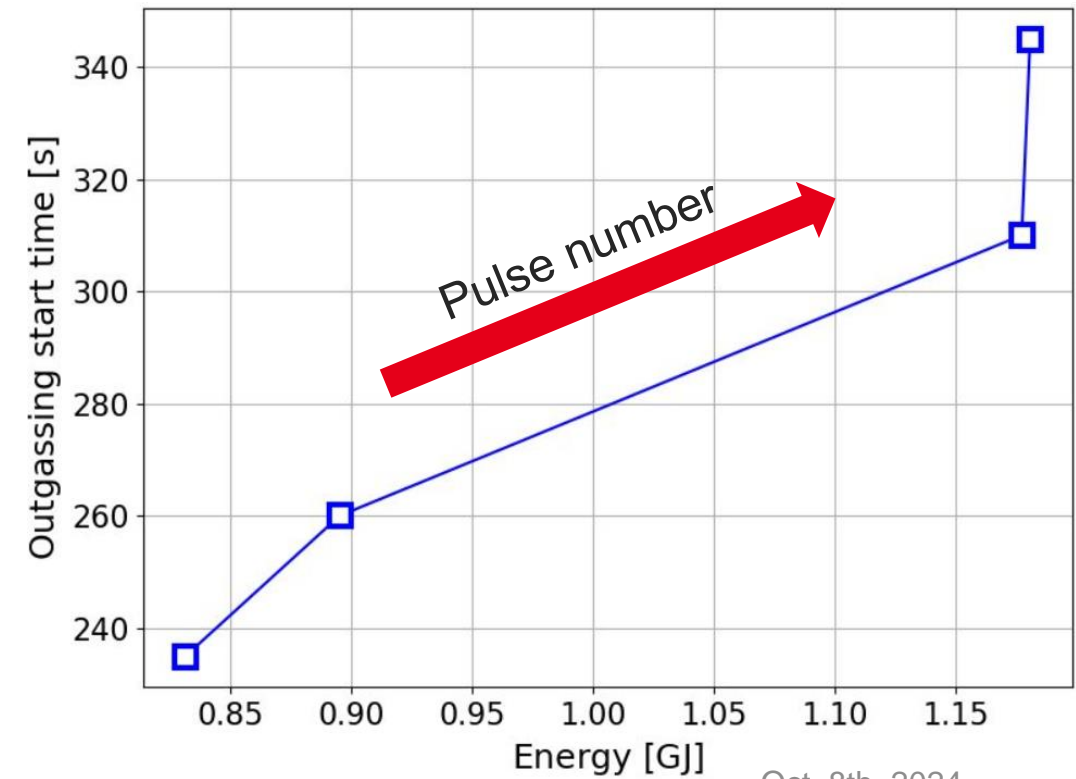
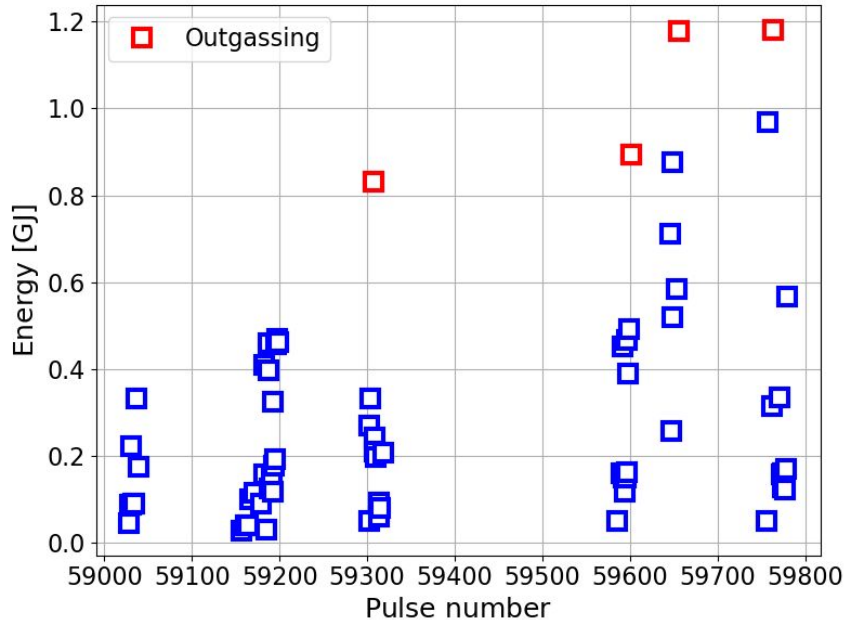



# A possible suspect: BN tiles on inner/outer bumpers

- Mass spectrometer displays
  - Dominant contribution of  $D_2$  mass
  - Gradual increase of  $H_2$  and HD masses, related to wall heating and subsequent outgassing
- **BN limiter tiles** (Region Of Interest #1 in IR analysis picture)
  - Known to outgas  $H_2$  at beginning of campaigns, when poorly conditioned
  - Reach higher max. temperatures during long pulses, consistent with slow conditioning observed
  - However contribution difficult to establish firmly (e.g. no temperature threshold observed for  $H_2$  release)
- BN tiles have been removed during shutdown, replaced by W tiles → **Impact on long pulses in forthcoming campaign to be assessed**

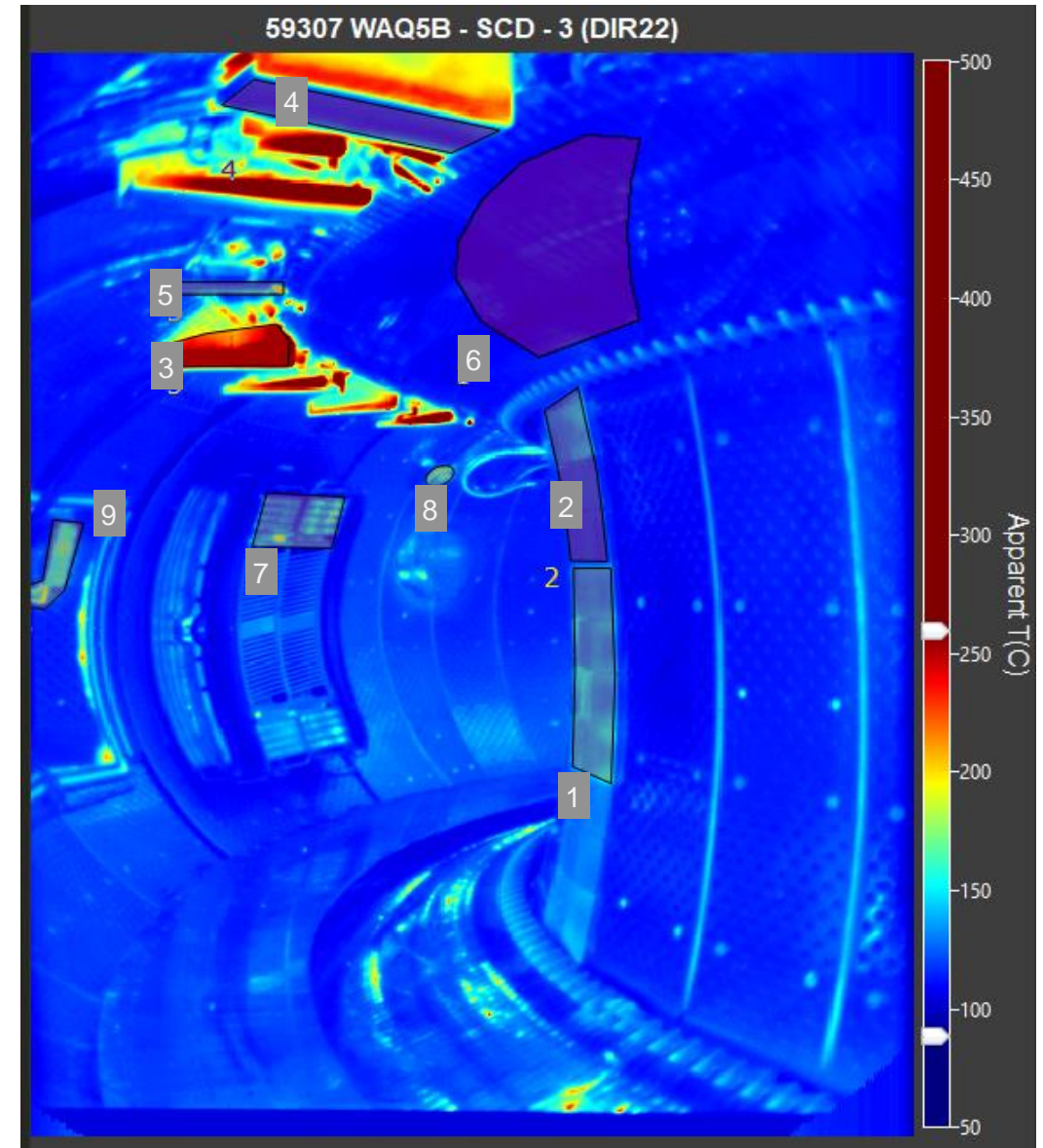



# 3 ■ Challenge #2: UFOs

# UFOs have significantly impacted high fluence operation in attached divertor conditions

- High Fluence campaign performed in 2023 in L-mode attached divertor regime
  - Cumulated plasma time of about 3h in attached regime ( $T_e$  divertor  $\sim 20$  eV), without boronisation
  - Cumulated fluence at lower divertor reached  $5 \times 10^{26}$  D/m<sup>2</sup> (more than an ITER PFPO pulse)
- Divertor erosion generates deposits, flakes and UFOs
  - Short peaks of radiated power, becoming more and more frequent  $\rightarrow$  impact on plasma operation
  - Extensive identification and analysis of UFOs performed [Gaspar, NME 2024]

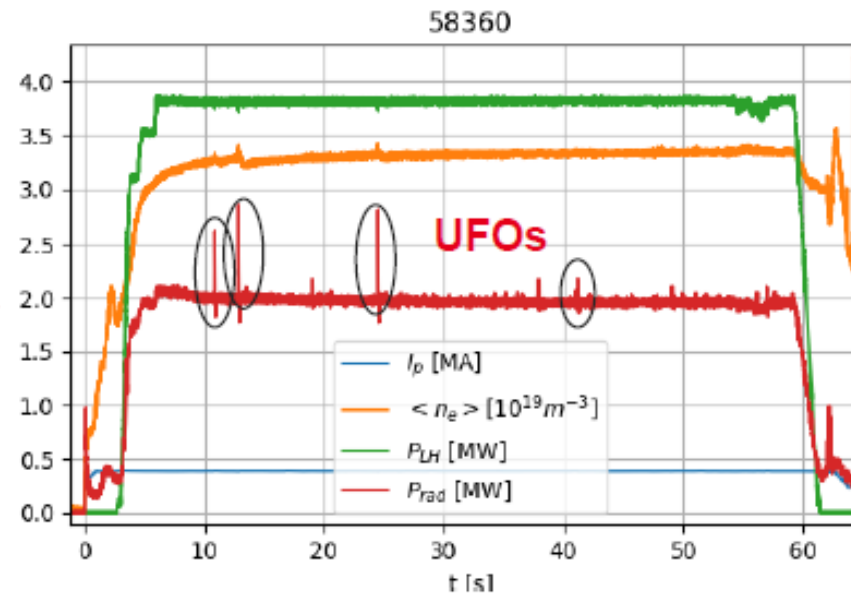
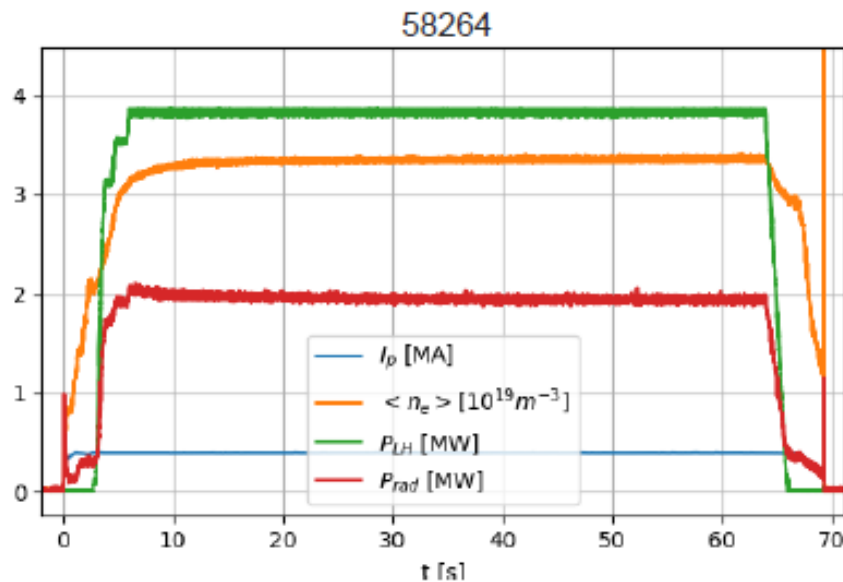

# Formation & ejection of flakes on divertor elements



- UFO classified in three categories
  - 1) Minor impact (~80%) / 2) Disruption after more than 0.2s (~17%) / 3) Disruption after less than 0.2s (~3%)
  - Stationary regime after ~ 100 min of plasma for classes 1 and 2, but class 3 still growing
- Similarities between WEST UFOs and W dust size evaluated on JET-ILW (~Ø140-180µm) [Sertoli, JNM 2014]
  - However, no UFO issues reported in JET high fluence experiments [Brezinsek, NF 2019]  
→ difference in divertor geometry, temperature, inner wall material?
- Origin of the UFOs
  - Temporal: mostly at the start of the additional power → thermal stress as the main trigger
  - Spatial: mostly coming from the High Field Side (HFS) region [Gaspar, NME 2024]
  - Historical: most UFOs originate directly from the thick deposits

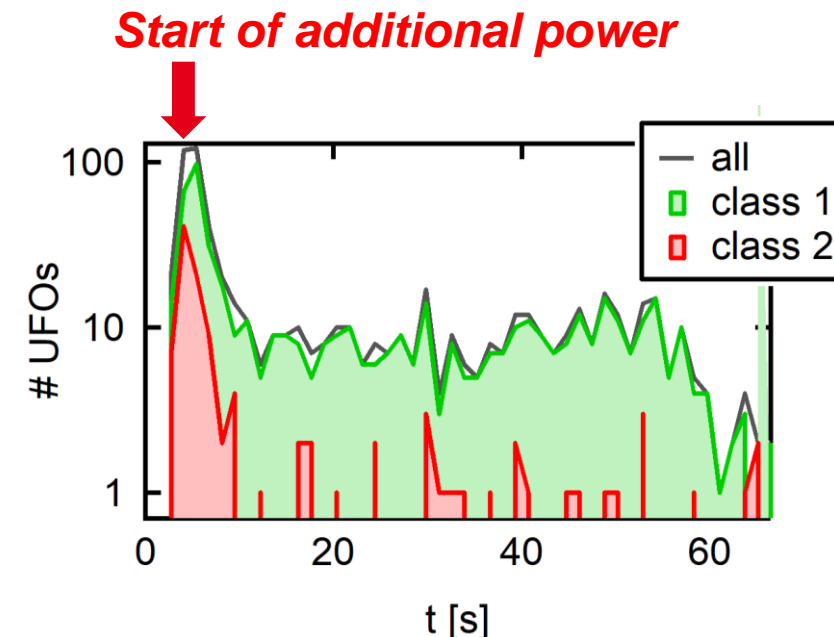
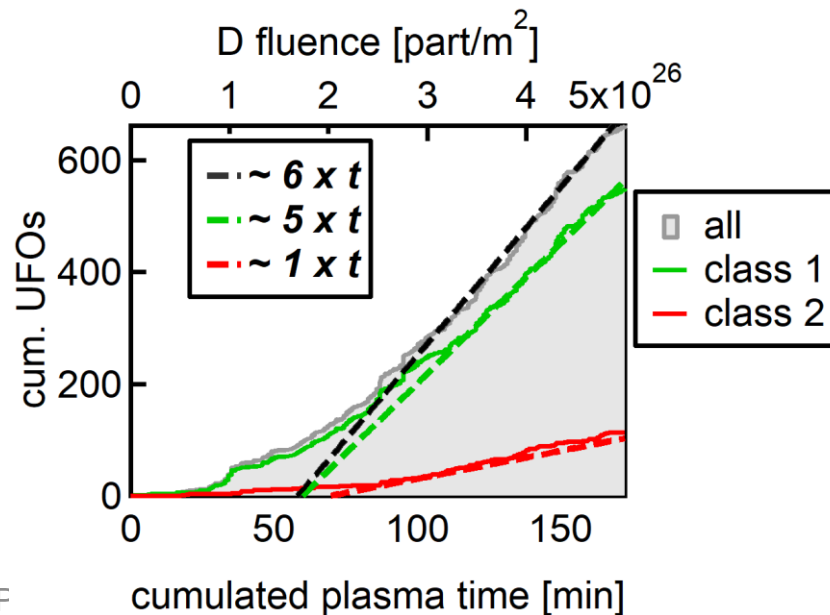



# UFO composition and radiation resilience

- UFO composition
  - From Zeff / bolometry measurements: mostly tungsten, but light impurities sometimes present
  - In line with previous post-mortem results on deposit composition [Hakola, NF 2021; Balden, PS 2021]
- Consequences for plasma operation:
  - **Class 1**: reduction of incoming W flux after UFO → fixed operation point in frad (resilience)
  - **Classes 2 & 3**: radiation peak impacts safety factor profile → MHD stability degraded

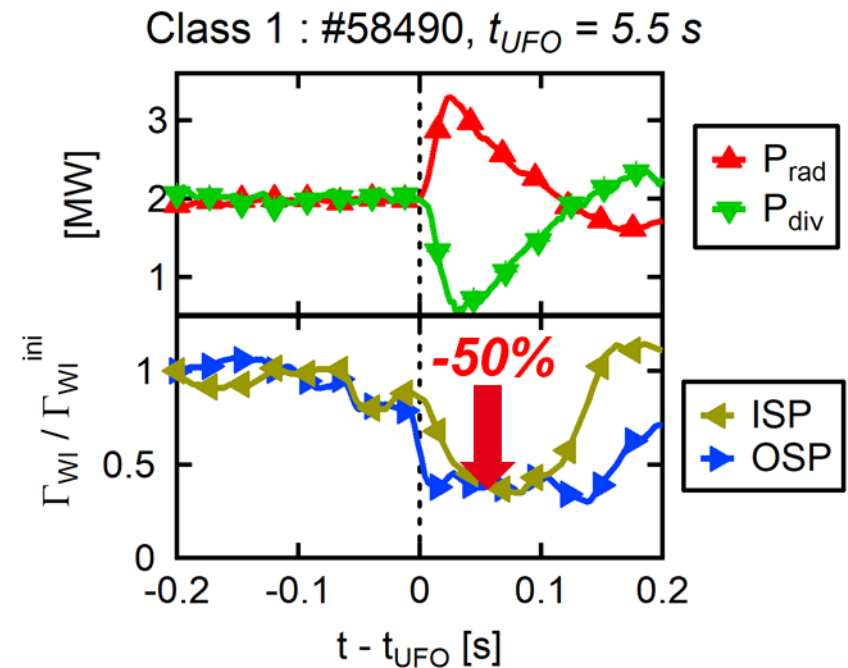
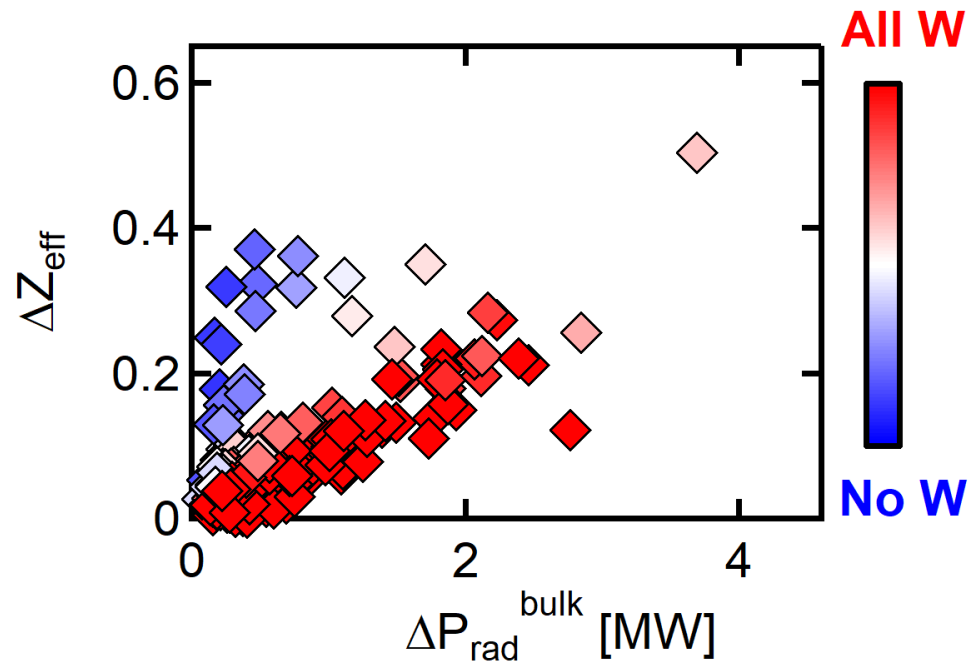

# Class 1 UFOs observed in non-inductive discharges, transiently impact performance

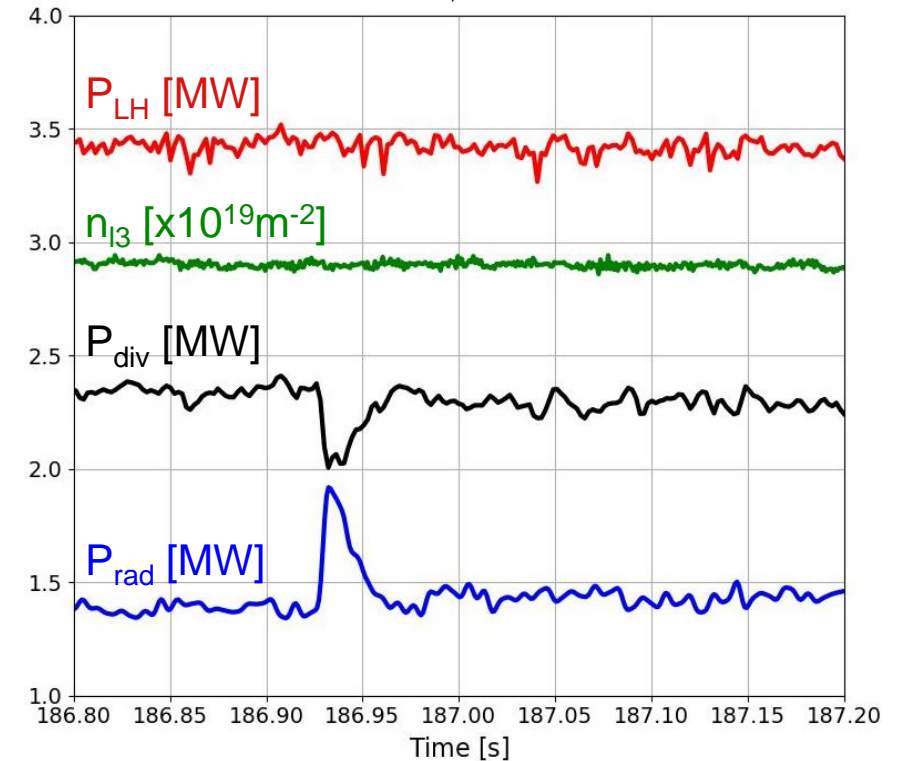
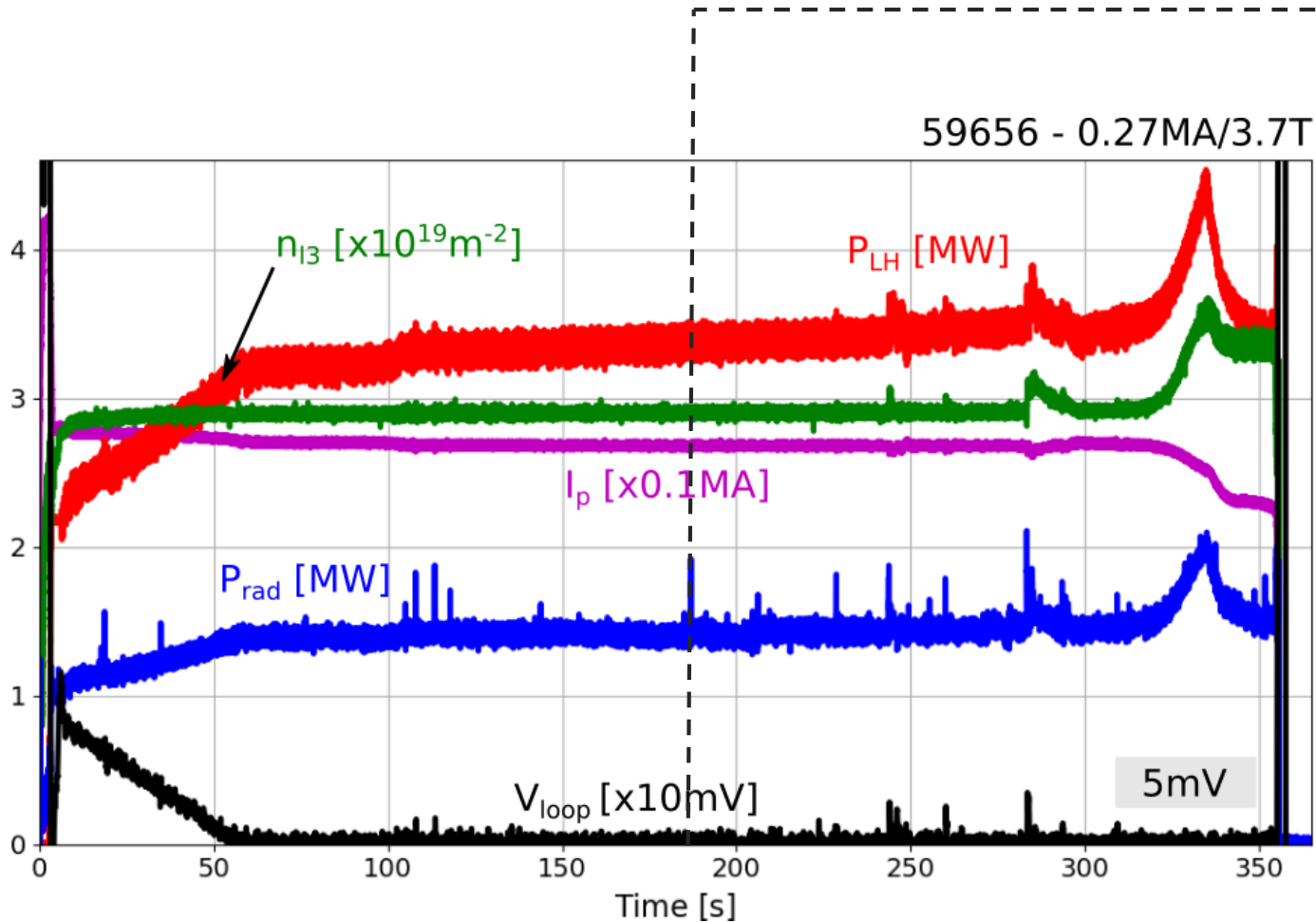

- **Smallest** UFOs does not impact density, loop voltage  $\rightarrow$  no LH power response

# Class 1 UFOs observed in non-inductive discharges, transiently impact performance

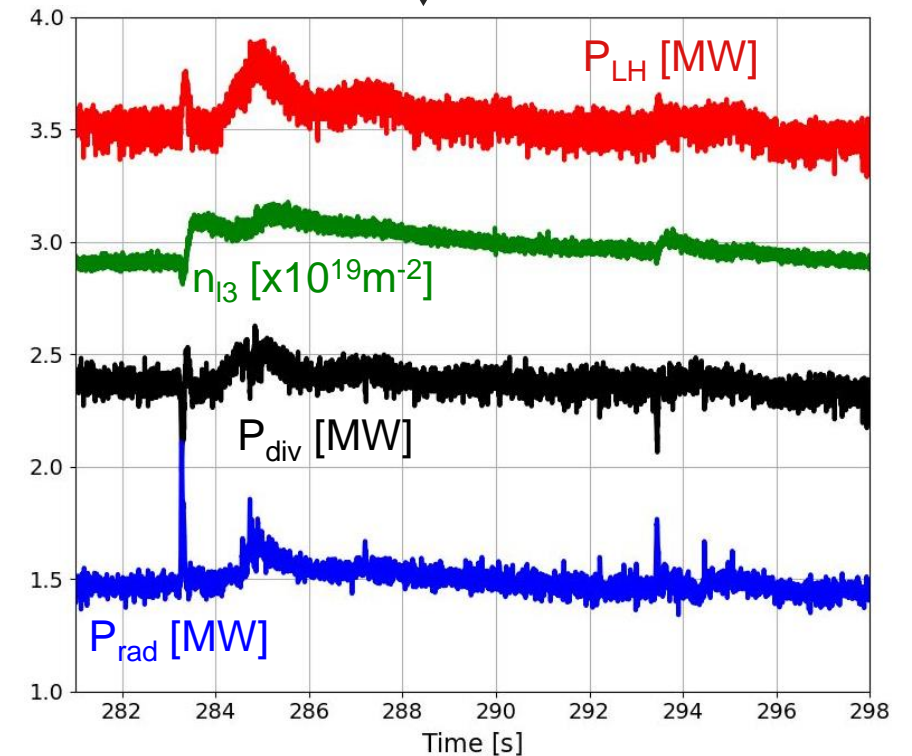
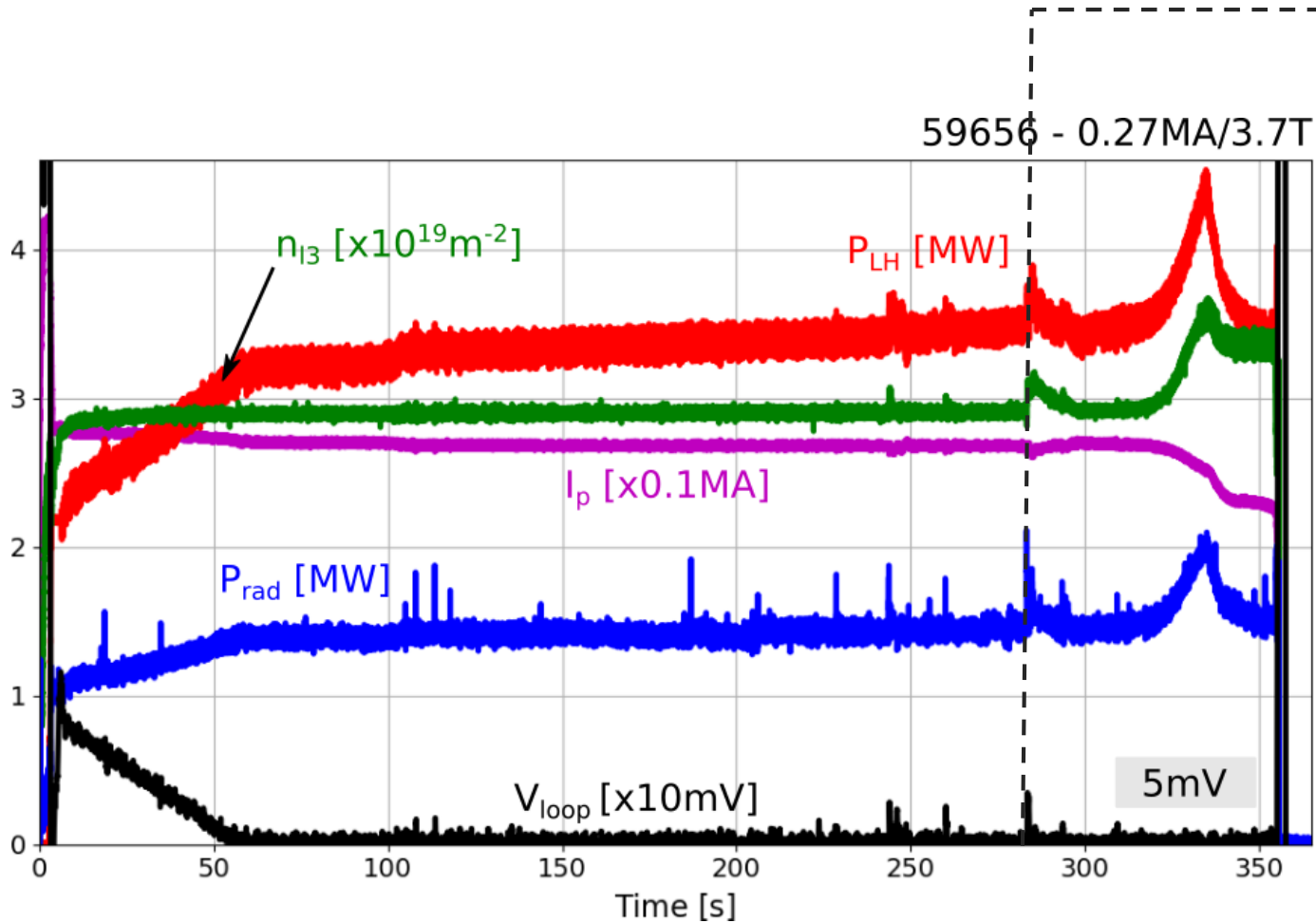

- Larger UFOs can increase significantly density, loop voltage, plasma current  $\rightarrow$  transient LH power response ( $\sim$ few seconds)

# Class 2 UFOs can alter current profile, leading to MHD crash and poor confinement

59307 – 0.32MA/3.7T

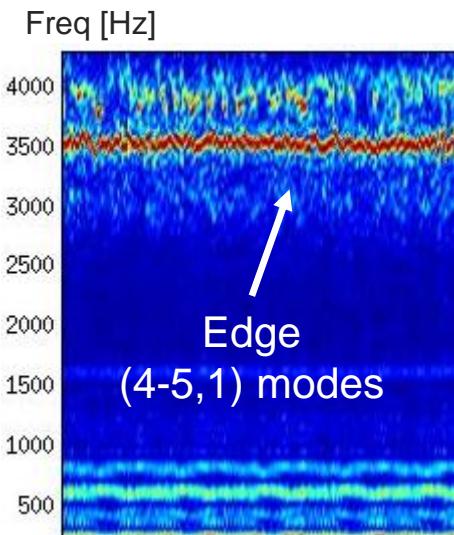
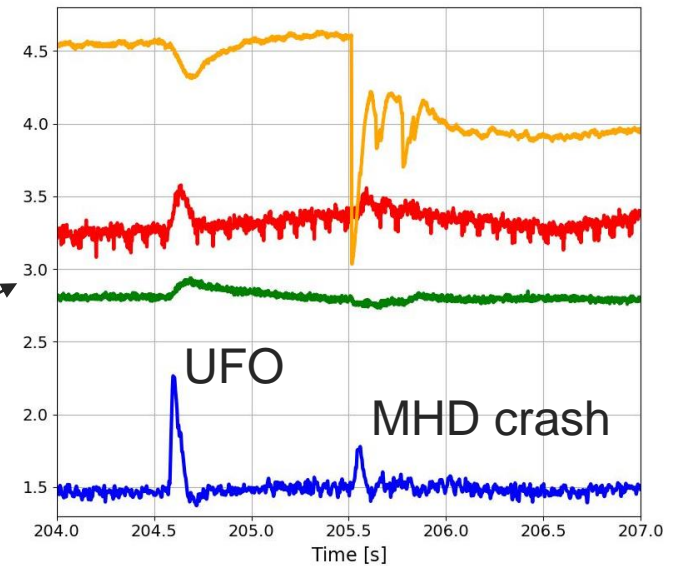
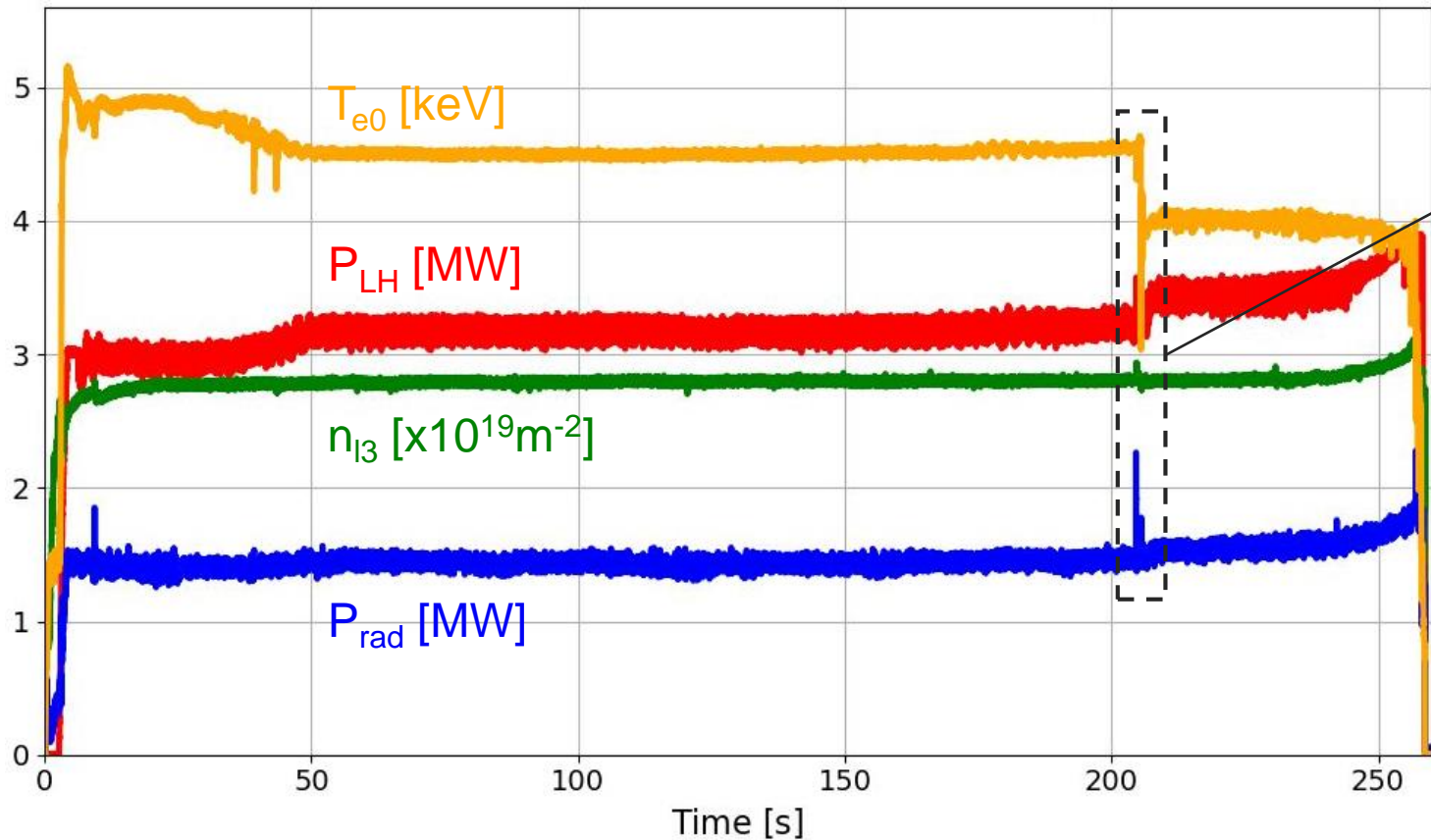

t~24s

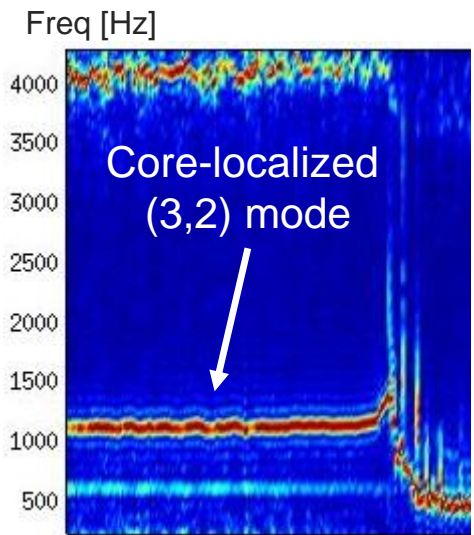

t~256s 23





# 4 ■ Outlook: EC power

# EC power to enlarge parameter space, help increase performance in non-inductive regimes

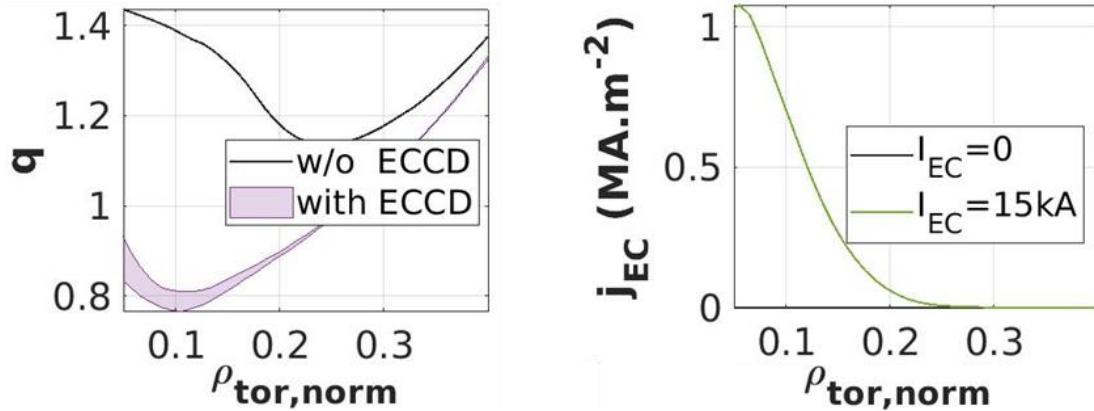

HFPS simulation of central ECCD to control q-profile reversal [Fonghetti, in preparation]

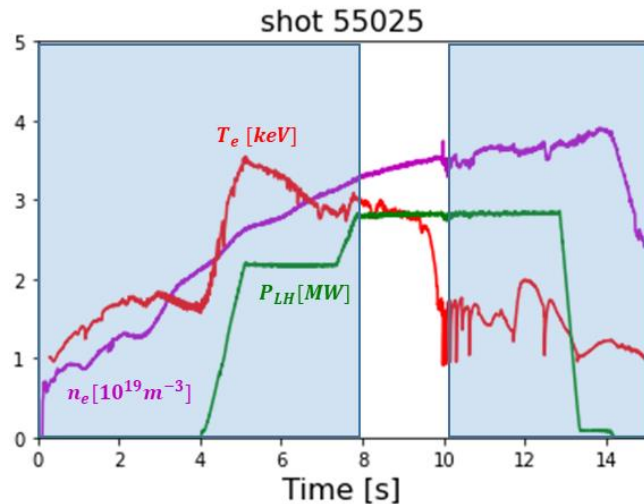

Radiative collapse in a LHCD-only pulse, caused by combination of W radiation and off-axis LH power deposition [Ostuni, NF 2022]

- EC power available in next WEST campaigns: 1MW in 2024 → 3MW in 2025
- Applications to long-duration pulses
  - Central ECCD to control q-profile reversal [Fonghetti, in preparation], improve overall CD efficiency → possibility to control current profile, operate at larger densities
  - Central ECRH against radiative collapses observed as density increased [Ostuni, NF 2022] or ICRF power applied [Maget, PPCF 2023]
    - Counterbalances central radiation in unstable range of electron temperatures ( $T_e \sim 1.5-3\text{keV}$ )
    - “Anchors” LH deposition profile to plasma core
    - Opens the possibility to use ICRF power, beneficial for MHD stability when  $V_{loop} \sim 0$  [Dumont, PPCF 2014]
- H-mode access
- MHD control
- ...

# Summary and prospects

- **Many adaptations to WEST hardware and software systems to prepare for long durations**
  - Opens the possibility to explore various aspects related to Long Pulse Operation relevant to future devices, including ITER:
    - Boronization and long-term influence of conditioning [Gallo, this conference; Afonin, this conference]
    - Deposits and flakes on divertor elements (e.g. UFOs)
    - Plasma-wall equilibration aspects impacting plasma scenarios (e.g. fuelling & exhaust, outgassing, ...)
- **Discharges with  $V_{loop}$  down to ~3mV achieved, could in principle be extended to >1000s durations**
  - Double feedback-control ( $V_{loop}$ ,  $V_{G0}$ ), ( $I_p$ ,  $P_{LH}$ ) successfully implemented
  - Outgassing appears when E reaches ~1-1.2GJ, possibly linked to BN tiles. Slow conditioning effect observed
  - UFOs can adversely impact performance
- **New record pulse: 364s (59763), over Tore Supra energy records**
  - Developed using “predict-first” integrated modelling based on reference discharges from previous campaign
- **Outlook**
  - Long-duration scenarios in low-temperature divertor regimes currently under development
  - EC power will enlarge parameter space, help increase performance in non-inductive regimes