



**HAL**  
open science

## A 57.6 Gb/s D-band point-to-point link based on real time baseband processors and transmissive RIS

José Luis Gonzalez Jimenez, Abdelaziz Hamani, Alexandre Siligaris,  
Francesco Foglia Manzillo, Antonio Clemente

► **To cite this version:**

José Luis Gonzalez Jimenez, Abdelaziz Hamani, Alexandre Siligaris, Francesco Foglia Manzillo, Antonio Clemente. A 57.6 Gb/s D-band point-to-point link based on real time baseband processors and transmissive RIS. EuMC 2024 - 54th European Microwave Conference, Sep 2024, Paris, France. pp.409-412, 10.23919/EuMC61614.2024.10732609 . cea-04904968

**HAL Id: cea-04904968**

**<https://cea.hal.science/cea-04904968v1>**

Submitted on 21 Jan 2025

**HAL** is a multi-disciplinary open access archive for the deposit and dissemination of scientific research documents, whether they are published or not. The documents may come from teaching and research institutions in France or abroad, or from public or private research centers.

L'archive ouverte pluridisciplinaire **HAL**, est destinée au dépôt et à la diffusion de documents scientifiques de niveau recherche, publiés ou non, émanant des établissements d'enseignement et de recherche français ou étrangers, des laboratoires publics ou privés.

# A 57.6 Gb/s D-band point-to-point link based on real time baseband processors and transmissive RIS

J.L. González-Jiménez<sup>#1</sup>, A. Hamani<sup>#</sup>, A. Siligaris<sup>#</sup>, F. Foglia Manzillo<sup>#</sup>, A. Clemente<sup>#</sup>, E. Pikasis<sup>§2</sup>, D. S. Kritharidis<sup>§</sup>, E. D. Tsirbas<sup>§</sup>, E. C. Loghis<sup>§</sup>

<sup>#</sup>Université Grenoble-Alpes, CEA-Leti, Grenoble, France

<sup>§</sup>Intracom Telecom, 19.7 km Markopoulou Ave., Peania, Athens, Greece, 19002

<sup>1</sup>jose Luis.gonzalezjimenez@cea.fr, <sup>2</sup>epikasis@intracom-telecom.com

**Abstract** — This paper presents a D-band link operating in the 129-157 GHz range based on multiple baseband channel aggregation. FPGA-based baseband units are used to generate and demodulate, in real time, several channels that are transmitted over the air along with other baseband channels coming from arbitrary waveform generators. The transmitter and receiver are implemented in 45-nm CMOS RFSOI technology, use on-chip LO generators and external commercial references. The antennas are based on transmissive RIS technology and achieve 27 dBi of antenna gain. The link demonstrates an overall data-rate of 57.6 Gb/s over 1 m distance using 16-QAM in all channels. The real-time baseband processor successfully demodulates 2 GHz channels carrying 5.4 Gb/s data in the presence of the other adjacent channel with resulting bit error rate before the FEC decoding of  $6 \cdot 10^{-3}$ .

**Keywords** — D-band, base-band processor, back-haul link

## I. INTRODUCTION

The D-band (100 to 170 GHz) is starting to be considered for front-haul and back-haul links [1] as natural evolution to existing E-band high-capacity links. This band offers large amount of bandwidth and opens the possibilities to 100 Gb/s and higher wireless data-rates. Some recent demonstrations of D-band point-to-point links over distances ranging from a few up to several hundreds of meters have been recently presented [2]-[6]. However this demonstrations only use a single channel, typically of 2 GHz of BW. In order to fully exploit the possibilities of the D-band spectrum, the communication using multiple-channels in the same links is still to be demonstrated. D-band transmitters and receivers able to operate with large bandwidths have been also reported [7], but the existing experiments required costly lab equipment to deal with the large base-band bandwidth and off-line signal processing for the modulation and demodulation operation. An alternative approach consists on using multi-channel transceivers combining multiple baseband channels with bandwidths that allows using real-time signal processing with a reasonable sampling rate. In this paper, a demonstration of a D-band link based on such type of channel aggregation links in which up to 8 2.16 GHz baseband channels are transmitted and received is presented. Some of the channels are generated and demodulated in real time using baseband units. A total raw data-rate of 57.6 Gb/s is demonstrated over the air using 16-QAM modulation and real time demodulation (including Forward Error Correction – FEC) in individual baseband channels for effective data rates of 5.4 Gb/s per channel.

## II. D-BAND LINK HARDWARE

### A. Transceiver architecture

The transmitter (Tx) is composed of two channel aggregation and up-conversion stages based on [8]. The Tx brings up to 16 baseband (BB) channels to D-band and places them at adjacent channel locations separated by 2.16 GHz. The first up-conversion stage takes four BB inputs and brings them to an intermediate frequency (IF) at V-band (see Fig. 1). The next stage takes two IF inputs provided by two parallel BB to V-band up-converters and brings them to two adjacent sub-bands at D-band: lower band (LB) from 139 to 148 GHz, and upper band (UB) from 148 to 157 GHz. The two stages are implemented by separate integrated circuits fabricated in 45-nm CMOS RFSOI technology. Each of the up-conversion stages is realized by a dedicated up-conversion lane with mixers. They are driven by on-chip generated local oscillators (LO) based on integer frequency multiplication from a much lower frequency external references [9]. The LO external references come from a commercial PLL operating at 4.32 GHz. The first stage channel aggregation is composed of four lanes and is realized with an on-chip power combiner. The second stage channel aggregation is realized over-the-air by the antenna sub-system as explained below.

The receiver (Rx) is composed of a couple of down-conversion lanes with dedicated LO signals generated on-chip. Each of the D-band transmitted sub-bands (LB and UB) is obtained at each of the two outputs of the Rx IC, also fabricated in 45-nm CMOS RFSOI technology. The Rx custom receiver provides the output at two V-band connectors. The V-band

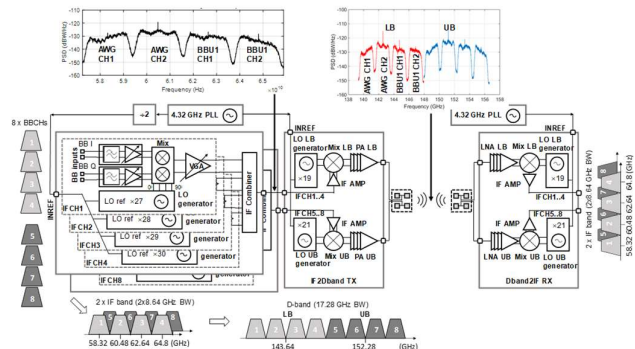

Fig. 1 Overview of the Tx and Rx radio front-ends with some experimental signal examples at different nodes of the circuits. Rx

signals are connected to a commercial IQ mixer and baluns to downconverter the received channels to BB. An external LO in the 60 GHz range is used to select the desired channel.

### B. Antenna sub-system

The Tx circuit shown in Fig. 1 is mounted on a low-cost PCB module where the in-package antennas, i.e. two pairs of aperture-coupled patches, are realized. The in-package antenna module is placed at the focal plane of a transmissive metasurface or transmit array (TA), as shown in Fig. 2. Each of the two in-package antennas is connected to one of the Tx sub-band outputs. The full band is obtained by over-the-air power combining of the two sub-bands, achieved thanks to a proper optimization of the phase profile of the TAs considering the fields emitted by the in-package antenna sources. The measured in-package antenna gain and the full antenna gain at boresight are shown in Fig. 2. The Rx uses the same approach for the antenna than the Tx.

The TA acts as a flat lens. It consist of a 48×48-element array where each element is chosen among a set of unit cells (UC). The UCs of the lens are designed as asymmetric linear polarizers [10], using only three metal layers, without any vias. The outer layers of all UCs are orthogonal wire grid polarizers. The element on the inner layer of each UC, referred to as rotator, is designed to rotate by 90° the incident field and introduce on it the desired phase shift. The stack-up of the lens comprises the same low-cost substrate materials of the AiPs and is shown in the insets of Fig. 3. The UC periodicity is 0.75 mm × 0.75 mm. Sixteen UCs were optimized using split rings and I-shaped patches (see inset of Fig. 3). The simulated transmission coefficients of the UCs, under normal incidence and in an infinite array environment, are all above 1 dB between 125 GHz and 160 GHz. In the same band, all phase responses are linear with frequency and provide an almost uniform 4-bit quantization of the 2π phase range.

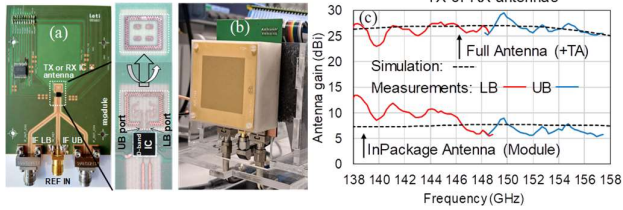

Fig. 2. (a) Receiver module and details of in-package antenna. (b) Transmitarray mounted over the in-package antenna module. (c) Measured and simulated boresight antenna gain of the in-package focal-plane antenna and of the overall system with the transmitarray.

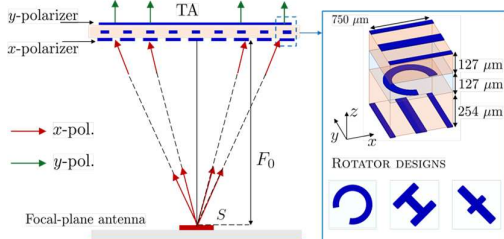

Fig. 3. Schematic view of the designed antenna systems: The distances between the AiP and the TA is  $F_0 = 25$  mm.

### C. Radio link performances and link budget

The Tx used in this system implementation of the point-to-point link, achieves an Equivalent Isotropic Radiated Power (EIRP) of 26 dBm at the output 1dB compression point, and consumes a total of 1.6 W when all the 16 baseband signals are transmitted at D-band. However, the power consumption can be reduced if some of the up-conversion lanes are turned off, saving power when the peak throughput is not required. The Rx has a gain of 25 dB and a noise figure (NF) of 12.5 dB [8]. The Tx and Rx antennas provide a gain of 27 dBi. The main radio link parameters are summarized in the Table 1 in the form of a link budget.

### III. BASEBAND UNIT

Figure 4 shows the block diagram of the baseband unit. All the demanding digital signal processing (DSP) functions required for the baseband signal transmission and reception, are performed on an FPGA-based board. This baseband unit is based on Intracom Telecom's E-band platforms consisting of two modems using 2 GHz channel bandwidth reaching bit rates up to 30 Gb/s using 512 QAM constellation size. On the transmitter side, the DSP methods perform the required function as sampling rate conversion, filtering, pulse shaping, signal conditioning. Also, the baseband unit provides the required control signals for interfacing with the digital-to-analog (DACs) and analog-to-digital converters (ADCs).

Table 1. D-band radio link budget

Parameter	Per channel	Full band
BW (GHz)	2.16	IF: 2×4×2.16 RF 8×2.16
BB I or Q diff. peak amp. (mV @ 100 Ω)	650	
BB I or Q rms amp. (mV @ 100 Ω)	234	
BB to IF up-converter gain (dB)	-29	
IF connections losses (dB)	1	
IF signal power (dBm)	-30.5	-24.5 (×2)
D-band Tx + antenna gain (dB)	37	
EIRP@1dBPC (dBm)	17	26
Back-off (dB)	9.4	
EIRP for IF power (dBm)	6.4	15.4
Path Loss @ 1 m (dB)	76	
Rx antenna gain (dBi)	26	
Rx NF at antenna (dB)	12.5	
Rx Signal @ antenna aperture (dBm)	-43.5	-34.5
Rx Eq. Noise @ antenna aperture (dBm)	-67.5	-58.5
SNR	24	
EVM for BER 10 <sup>-2</sup> on 16-QAM (dB)	-15	
Margin for other RF impairments (dB)	9	

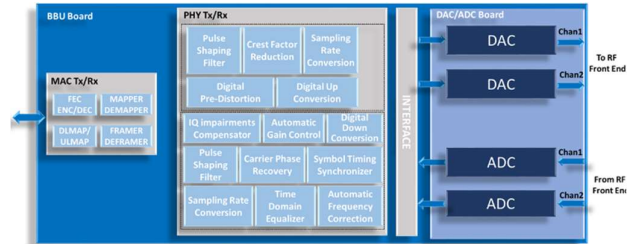

Fig. 4. An abstract block diagram of the baseband unit

On the receiver side, the baseband processor performs signal decoding using symbol timing, frame synchronization, carrier frequency offset cancellation, carrier phase-noise correction, filtering, equalization, symbol de-mapping, and FEC decoding processes.

#### IV. EXPERIMENTAL SET-UP AND RESULTS

The complete link test set-up is schematically illustrated in Fig. 5. The D-band radio link accepts several BB channels inputs. In order to simplify the set-up, only one BB to V-band (BB2V) up-converted board is used, and the same IF signal is used to transmit in both LB and UB sub-bands over the air using the two channels of the D-band Tx (V2D in Fig. 5). The D-band Rx (D2V) outputs the LB and UB signals at IF at two different connectors that can be connected to the V-band to BB (V2BB) downconverter circuitry (see section II-A). Please note that the Tx and Rx use a couple of commercial reference generators that are not synchronized to each other.

A first set-up is implemented by connecting all the BB inputs to a multichannel arbitrary waveform synthesizer. In this configuration, the channel symbol rate is 1.8 Gbauds and the total over-the air signal carry 8 BB channels with 16-QAM modulation, for a total of 57.6 Gb/s raw data-rate. The two IF (LB and UB) signals of the D2V board are sampled by the scope and signal demodulation is done off-line using a Matlab implementation of the digital BB receiver described in [11]. The results are shown in Fig. 6 for a 1 m link. Next the link distance between the two T-RIS is varied and raw bit error rate (BER) is recorded (see Fig. 7). The measured data agrees with the theoretical BER derived from EVM values obtained from the measured SNR, oscillators phase noise jitter and 6 dB of degradation due to other RF impairments such as channel-to-channel interference and I/Q imbalance. Carrier Frequency Offset between Tx and Rx is compensated by the DBB and has been measured to be between 200 kHz to 300 kHz, depending on the channel. The link performance is limited by noise at distances large than 1 m (the target uncoded BER is  $10^{-2}$ ) and gets limited by phase noise at distances shorter than 50 cm. Longer distances can be achieved by increasing the transmit power using external power amplifiers and by increasing the receiver gain with external low noise amplifiers.

In the second experimental set-up, two of the B2V BB inputs are replaced by the Tx channels outputs of the BB units. In that case, the V2B output is also connected to the corresponding Rx BB inputs of the BB units. This set-up is shown in Fig 8.

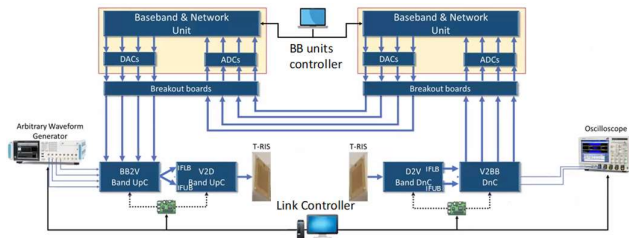

Fig. 5. D-band link set-up.

The I/Q signal components from the two modems are generated through the DACs from an FPGA based baseband

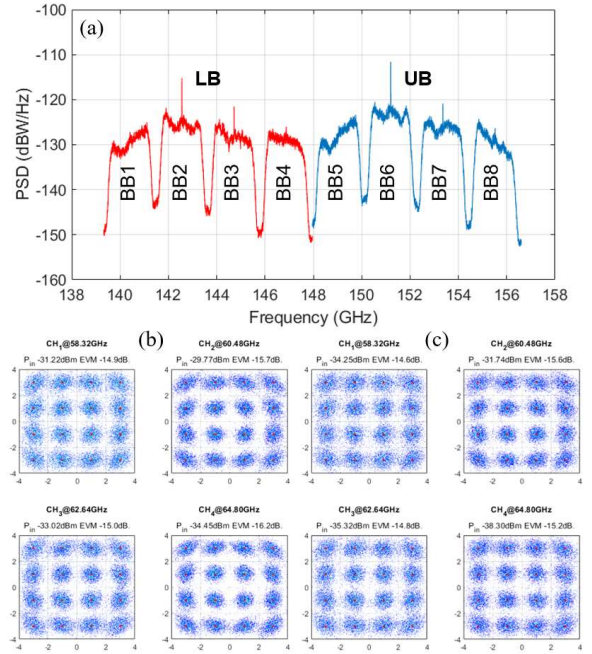

Fig. 6. (a) Received signals at both LB and UB IF outputs against their corresponding D-band frequencies. Demodulated 16-QAM constellations for (b) the four LB channels, and (c) the four UB channels.

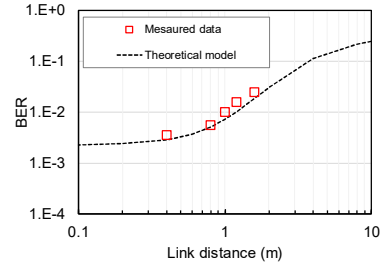

Fig. 7. Comparison of BER, calculated from EVM, to actual measurements.

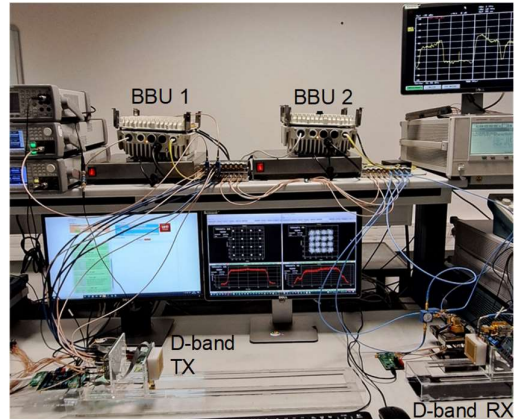

Fig. 8. D-band link set-up combining two BB units and the Tx and Rx radio front ends.



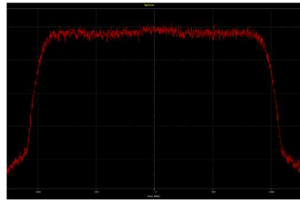

Fig. 9. The magnitude spectrum of the digital I/Q data signals (pre-DAC)

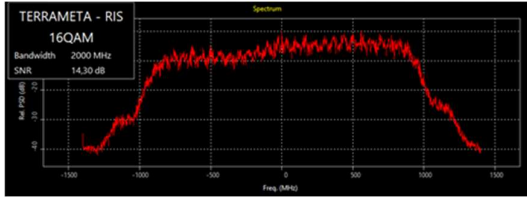

Fig. 10. Spectrum of the received I/Q data streams in the 1st modem

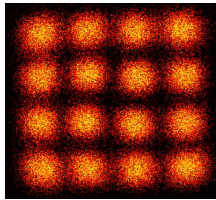

Fig. 11. Constellation diagram of the recovered QAM signal of the 1<sup>st</sup> modem of the baseband unit.

unit. A powerful and efficient concatenated forward error correction (FEC) scheme using Low Density Parity Check (LDPC) and Reed Solomon (RS) encoding is employed. Dedicated DSP modules implement different functions like pulse shaping, filtering for sampling rate conversion equipped with the required signals for the DAC interfaces.

The magnitude spectrum of the digital I/Q data signals (before the generation from the DAC) is depicted in Fig. 9. The symbol rate of the produced I/Q signals is fixed at 1.6 GBaud using a 2 GHz channel bandwidth. The supported bit rate for the case of 16-QAM is 5.4 Gb/s for each channel. The generated I/Q data signals from both modems are used as baseband inputs to the V-band I/Q up converter.

After the V-band to the baseband down-conversion in the Rx, the produced distorted baseband I/Q signals are captured by the ADCs of the baseband unit. Fig. 10 shows the magnitude spectrum of the received I/Q data signals after the ADCs modules. Next, the FPGA recovers the I/Q data streams performing all the required DSP functions to combat the anticipated V- and D-band specific impairments. In parallel, each modem can extract key performance indicators, such as the constellation diagram, signal-to-noise ratio (SNR), and bit error ratio (BER). The constellation diagram of the recovered QAM signals for the case of 16QAM is depicted in Fig. 11. The SNR values are calculated from the extracted constellation diagram in real time and in this case was 14.3 dB. The value of the pre-FEC BER for this constellation diagram was  $6 \cdot 10^{-3}$  corresponding to an EVM value of -14.6 dB.

## V. CONCLUSION

This work presents a demonstration of real time traffic over a wireless D-band link with multiple channels transmitted

simultaneously. The digital baseband receiver is able to demodulate a 5.4 Gb/s signal from the 16-QAM modulated analog-baseband signal coming from the D-band receiver. The overall link data rate is 56.4 Gb/s and the link operates at distance of 1 m using 27 dBi transmissive RIS antennas. This is the first time, to best of the authors' knowledge, that a D-band link operating over a band of more than 16 GHz is demonstrated with real time traffic communication and demodulation at baseband with per channel data rates of up to 5.4 Gb/s and 16 QAM modulation in all the channels. These results pave the way to energy efficient and agile front-haul and back-haul systems able to exploit the large amount of bandwidth available at D-band for 100 Gb/s data rate communications.

## ACKNOWLEDGMENT

This work is partially supported by the European Commission through SNS JU project TERRAMETA of the European Union's Horizon Europe research and innovation program under Grant Agreement No 101097101.

## REFERENCES

- [1] M. G. L. Frecassetti, J. F. Sevillano, D. del Río, M. I. Saglam, A. Lamminen and V. Ermolov, "D-Band Backhaul and Fronthaul Solutions for 5G Radio Access Network," *2022 52nd European Microwave Conference (EuMC)*, Milan, Italy, 2022, pp. 772-775.
- [2] A. A. Farid, A. S. H. Ahmed, A. Dhananjay, P. Skrimponis, S. Rangan and M. Rodwell, "135GHz CMOS / LTCC MIMO Receiver Array Tile Modules," *2021 IEEE BiCMOS and Compound Semiconductor Integrated Circuits and Technology Symposium (BCICTS)*, Monterey, CA, USA, 2021, pp. 1-4.
- [3] V. Vassilev *et al.*, "Spectrum Efficient D-band Communication Link for Real-time Multi-gigabit Wireless Transmission," *2018 IEEE/MTT-S International Microwave Symposium - IMS*, Philadelphia, PA, USA, 2018, pp. 1523-1526.
- [4] A. Ahmed, M. Jung, S. Li, L. Li and G. M. Rebeiz, "Scalable Phased-Arrays at 140 GHz using RF and IF Beamforming Techniques," *2023 53rd European Microwave Conference (EuMC)*, Berlin, Germany, 2023, pp. 146-149.
- [5] Evangelos Pikais, "Error-free bidirectional transmission in a D-band P2P link, Novemver 2023, [Thumbnail with link attached] [Post]. LinkedIn. [https://www.linkedin.com/posts/evangelos-pikais-7b634583\\_an-error-free-bidirectional-transmission-activity-712361022710319104-TQlL/](https://www.linkedin.com/posts/evangelos-pikais-7b634583_an-error-free-bidirectional-transmission-activity-712361022710319104-TQlL/)
- [6] Nokia, "Nokia demonstrates live D-Band microwave backhaul connection," April, 2022. [Press release] <https://www.nokia.com/about-us/news/releases/2022/04/13/nokia-demonstrates-live-d-band-microwave-backhaul-connection/>
- [7] F. Strömbeck, Y. Yan and H. Zirath, "An 80 Gbps QAM-16 PMF Link Using a 130 nm SiGe BiCMOS Process," *2023 IEEE/MTT-S International Microwave Symposium - IMS 2023*, San Diego, CA, USA, 2023, pp. 443-445.
- [8] A. Hamani, *et al.*, "A 56.32 Gb/s 16-QAM D-band Wireless Link using RX-TX Systems- in-Package with Integrated Multi-LO Generators in 45nm RFSOI," *2022 IEEE Radio Frequency Integrated Circuits Symposium (RFIC)*, Denver, CO, USA, 2022, pp. 75-78.
- [9] A. Siligaris, *et al.*, "A Multichannel Programmable High Order Frequency Multiplier for Channel Bonding and Full Duplex Transceivers at 60 GHz Band," *2020 IEEE Radio Frequency Integrated Circuits Symposium (RFIC)*, Los Angeles, CA, USA, 2020, pp. 259-262.
- [10] O. Koutsos, F. Foglia Manzillo, A. Clemente and R. Sauleau, "Analysis, rigorous design, and characterization of a three-layer anisotropic transmitarray at 300 GHz," *IEEE Trans. Antennas Propag.*, vol. 70, no. 7, pp. 5437-5446, July 2022.
- [11] J.L. Gonzalez-Jimenez, C. Dehos, N. Cassiau, *et al.* "Channel-bonding CMOS transceiver for 100 Gbps wireless point-to-point links," in *J Wireless Com Network*, vol. 117, pp. 1-21, 2020.