



HAL
open science

Increasing flexibility of historical power generation thanks to micro hybrid concept, the XFLEX HYDRO live demonstrator at vogelgrun HPP

Jean-Louis Drommi, Grégory Païs, Nicolet Christophe, Landry Christian

► **To cite this version:**

Jean-Louis Drommi, Grégory Païs, Nicolet Christophe, Landry Christian. Increasing flexibility of historical power generation thanks to micro hybrid concept, the XFLEX HYDRO live demonstrator at vogelgrun HPP. CIGRE 2022, Aug 2022, paris, France. pp.1083. cea-04832777

HAL Id: cea-04832777

<https://cea.hal.science/cea-04832777v1>

Submitted on 12 Dec 2024

HAL is a multi-disciplinary open access archive for the deposit and dissemination of scientific research documents, whether they are published or not. The documents may come from teaching and research institutions in France or abroad, or from public or private research centers.

L'archive ouverte pluridisciplinaire **HAL**, est destinée au dépôt et à la diffusion de documents scientifiques de niveau recherche, publiés ou non, émanant des établissements d'enseignement et de recherche français ou étrangers, des laboratoires publics ou privés.

**INCREASING FLEXIBILITY OF HISTORICAL POWER
GENERATION THANKS TO MICRO HYBRID CONCEPT, THE
XFLEX HYDRO LIVE DEMONSTRATOR AT VOGELGRUN HPP**

Jean-Louis DROMMI
EDF, France, jean-louis.drommi@edf.fr

Dr. Gregory PAIS
CEA INES, France, gregory.pais@cea.fr

Dr Christophe NICOLET, Dr Christian LANDRY
Power Vision Engineering, SUISSE
Christophe.nicolet@powervision-eng.ch ; Christian.landry@powervision-eng.ch

SUMMARY

The current upheaval in the share between regulating and non-regulating means of electric power generation is leading the European authorities to prepare the networks of the future, in particular their continuity of service and the quality of frequency and voltage.

In this general global context, XFLEX Hydro is proposing to implement and test innovative operating flexibility levers on hydroelectric facilities, through industrial full-scale demonstrators.

One of the facilities includes the hybrid demonstrator located at Vogelgrun Run of River plant.

There, XFLEX Hydro will show how Run of River plant, can still provide grid support (frequency primary control) together with an improved life expectancy of their main components. Indeed, primary frequency control could, eventually, be detrimental to some unit part either from fatigue or component wear.

The hybrid demonstrator therefore intends to achieve: “more service, with less wear and tear”, by using a small size battery (Battery Energy Storage System: BESS) which is to operate in tandem with the original hydraulic unit.

To achieve this goal, a control algorithm has been developed and implemented in a controller driving both hydro unit and BESS set points. Behavior of the hydro unit was simulated thanks to a numerical model running on SIMSEN software to achieve best efficiency scenario. Wear and Tear is assessed through data collection on hybrid and sister unit together with a digital clone.

The demonstrator entered operation in August 2021 so that related data analytics are ongoing.

KEYWORDS

Hydro Power; Flexibility; Hybrid; Wear and Tear; Ancillary Services; Battery; Simulation

1. Background

Climate change is driving many energy policies worldwide. To achieve a massive reduction (80% - 95%) in greenhouse gas emissions by 2050, the European Union (EU) expects that Renewable Energy Sources (RES) share should rise up to 97% of the European power generation mix [1]. In order to achieve such ambitious but necessary goal, non-dispatchable RES will represent an ever-greater share in the generation mix in years to come. The traditional generators (steam or hydro) are typically synchronous rotating machines that are controllable and dispatchable in terms of power output and are capable of providing a suite of services to the power grid such as inertia and power balancing (capacity of providing regulating power to the grid to ensure the load/generation balance). With the increasing percentage of non-dispatchable RES connected to grid and the decreasing number of flexible dispatchable power plants, it is crucial to expand and enhance these services to support the quality of electricity delivered to customers through power grids. As a consequence, remaining dispatchable plants are expected to keep providing flexibility services and a greater share of power balancing. Though existing units are able to provide the required service, increasing their burden is to result in greater wear of the prime mover components and hence greater maintenance or probable failure [2]. To mitigate such consequences on their asset, Plant owners are seeking ways to keep providing flexible services together with a lesser wear and tear of equipment, this is where hybridization plays its part.

1.1. Historical Performance of hydropower

For a century, hydro power has been providing electricity to grids worldwide. Its global share still represents 16.8% of the world electrical generation [3].

Hydro also has always demonstrated very flexible abilities [4] such as : fast start up, fast ramp up ramp down, load following, grid voltage support, and more...

Hydro units can be sorted between peaking units, operating daily during peak hours only, Run of River (RoR) units operating almost 24/7 thanks to a regular water stream (river or canal), Pump Storage Scheme (PSP) with the ability to store energy on the GWh scale in their upper reservoir.

In the wake of increased share of non-dispatchable REN sources, hydro contribution to ancillary services is expected to grow, leading to greater stress on unit components. Hydro peaking units and Pump Storage units will be put to greater contribution, but also Run or River units where ancillary services are technically feasible. Indeed, primary control means power adjustment several times per minute which could, eventually, be detrimental to turbine part fatigue.

As a matter of fact, Run of river plants have to cope with several constraints that may hinder their full flexibility. As an example, RoR plants located on commercial routes, have to keep canal levels for navigation purpose in which case, flexibility services come second if any.

Moreover, water head of RoR units is often low so that it is equipped with double regulating Kaplan turbine whose maintenance cost are known to be high [10].

1.2. The XFLEX HYDRO project

The XFLEX HYDRO project is a four-year project granted by the European Union which aims to demonstrate solutions to build a low carbon and climate resilient future for the energy system mix. The main objective is the demonstration of the increased potential of the hydroelectric technologies in providing flexibility to the power system while optimizing operation and maintenance assets. In particular, several hydroelectric technology solutions - such as fixed and variable speed, hydraulic short circuit operation, battery hybridisation, and digitalisation - are investigated and implemented to draw the road-map for the deployment of these technology to the all kinds of European hydroelectric power plants, run of river, storage and pumped storage of all sizes; being existing, uprated or new.

1.3. Case of Vogelgrun Run of River demonstrator

Vogelgrun Hydro Plant is located on the Grand Canal d'Alsace, 80km South of Strasbourg.

It is operated by Electricité de France and features 4 units equipped with double regulating Kaplan turbines. Total installed capacity is 160MW. Yearly generation accounts for 776GWh

The scheme also includes 2 large locks to accommodate commercial barges between Rotterdam and Basel. 20 000 boats use these locks each year so that keeping navigation open is a very high stake goal. On top of the above requirements, all 4 units contribute to primary frequency control (FCR) with a 5% droop.

Together with more demanding load following burden and faster FCR response, unit governing systems are to undergo more wear and tear leading to greater maintenance work and associated downtimes. In order to cover both aspects dealing with more stringent FCR requirement and keeping wear and tear to reasonable levels, hybridization came as a proven solution. Examples of RoR units being hybridized with batteries (BESS) have been described [2] where the whole FCR service is transferred onto the BESS. As a proof of concept, such full service transfer may make sense but the economics show long payback time (same order as battery life expectancy), notwithstanding that wear and tear economics is difficult to assess. For hybridization concept to become economically viable, battery size reduction appears as a must.

1.4. Micro hybrid concept

Taking advantage of the XFLEX Hydro project framework, one unit of Vogelgrun RoR plant has been selected to be hybridized with a small size battery. In this very case, FCR service is not fully transferred to the BESS. BESS and hydro unit work in tandem, thanks to a joint control algorithm. The BESS provides small but frequent and fast power variation, whereas the hydro unit still contributes to FCR when grid variation are deeper than what the battery can handle, or last for too long and would deplete/overcharge the battery. In a way, through micro hybrid concept, power and energy aspect of the FCR service are decoupled: power being addressed by the BESS and energy by the hydro unit thanks to water stored in the upstream canal.

To accommodate both objective (faster FCR and less wear and tear) of the micro hybrid concept, performance indicator targets have to be set so as to properly size the BESS.

As a matter of FCR compliance, the hybrid unit has to comply with the French TSO (RTE) requirements based on 30 seconds time response (95%) together with 15 minute hold time.

Regarding wear and tear, it was decided that halving the turbine servo motor mileage would be a noticeable achievement.

2. Proof of Concept through simulation

2.1. Validation SIMSEN model

A SIMSEN model of Vogelgrun HPP was developed including the water intake, the Kaplan turbine and the draft tube of the unit, see Figure 1. A particular attention has been paid to the modeling of the spiral case in order to consider the evolution of the cross-section area and the distribution of the discharge. The hydraulic part of the numerical model was validated by comparing the simulation results with time series of static pressure in the spiral case and the rotational speed of the Kaplan turbine measured during an emergency shutdown performed in 2015, see Figure 2. For this validation, the water level in the upstream and downstream reservoirs, as well as the closure laws of the guide vanes and blades are the input data of the SIMSEN model. The good agreement between the experimental data and the numerical results validates the hydraulic part of the SIMSEN model and the total inertia of the Kaplan turbine.

The SIMSEN model also includes a turbine governor combining the control of the flow of the Rhin river and the frequency primary control. The turbine governor is operated in guide vane position control mode and uses on-cam look-up table to define the blade angle set point as function of the head and the guide vane position. The validation of the control part in the SIMSEN model was performed by comparing the numerical simulation results with the site measurements performed over 2 days in April 2021, see Figure 3. By using turbine flow set point and grid frequency time histories, it was possible to reproduce the time evolution of the active power, guide vane opening and blade angle with good agreement. Thus, the good reproduction of the active power Pe validated the characteristic curve of the Kaplan turbine. Moreover, the good agreement for the guide vane opening y confirmed the turbine governor. Finally, the on-cam curve was also attested with the comparison of the blade angle β .

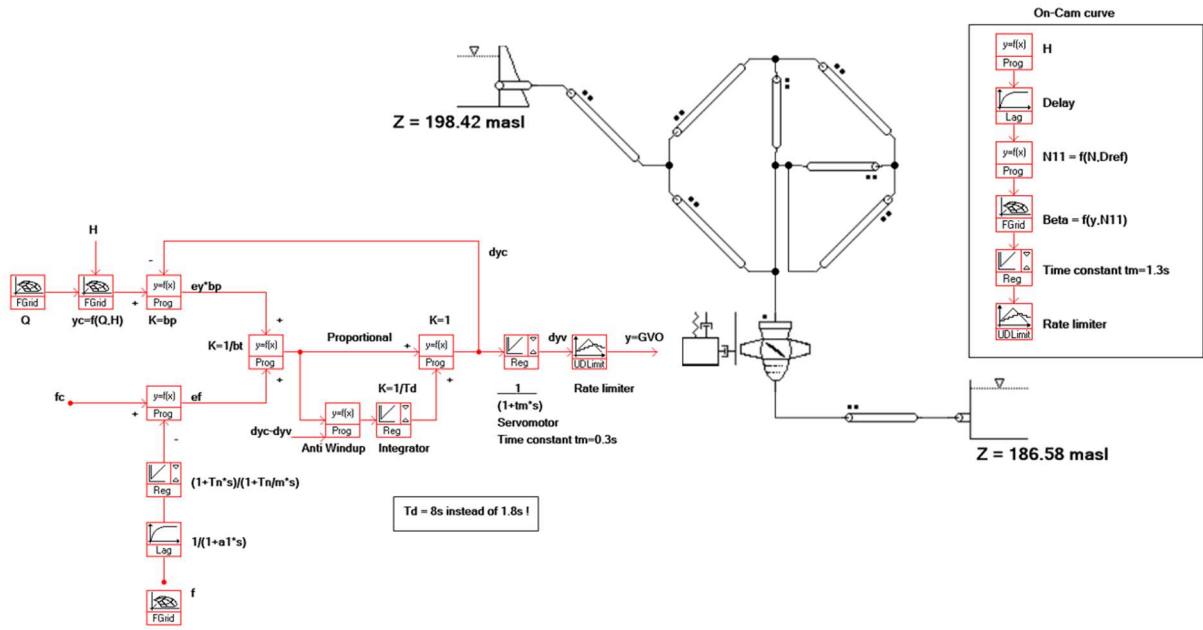

Figure 1 SIMSEN model of the Vogelgrun HPP

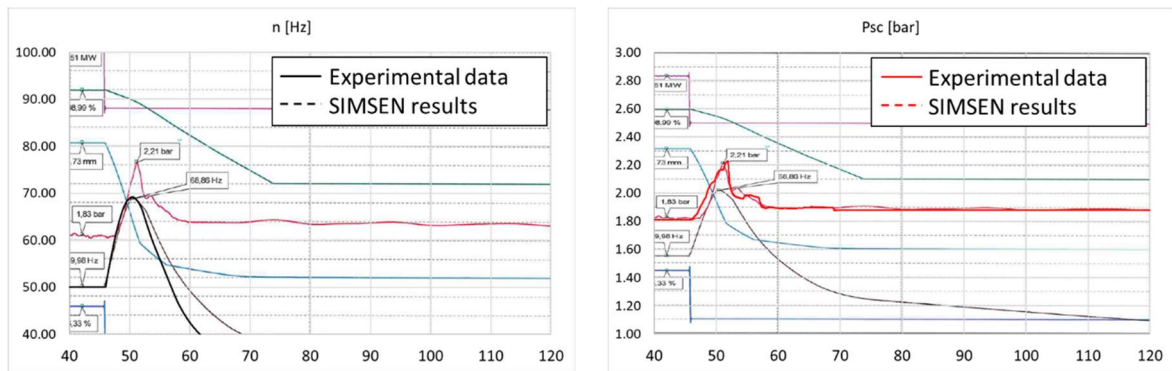

Figure 2 Comparison of the experimental data with numerical results for the rotational speed (left) and the static pressure in the spiral case (right)

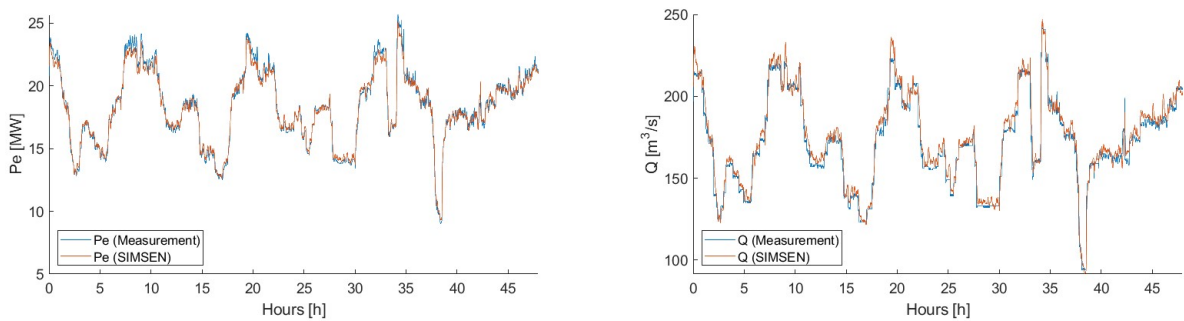

Figure 3 Comparison of the experimental measurement (blue line) performed over 2 days in April 2021 and the numerical results (red line).

2.2. Micro Hybrid BESS sizing CEA

Vogelgrun hybrid demonstrator is driven by FCR dynamic response together with reduced wear and tear. These two goals led the BESS sizing.

The grid frequency parameter is the main input to the primary control response. On the Vogelgrün demonstrator, a 4% droop was selected. The hydro power unit can generate 40 MW as rated output which means 4 MW are reserved to balance frequency deviation.

The first step of this study was to obtain the power profile applied to the battery in order to size the energy capacity and the maximum power of this storage system. This power profile is computed from frequency measurement over a one-year period at sampling rate of 1 second and an accuracy of 1mHz.

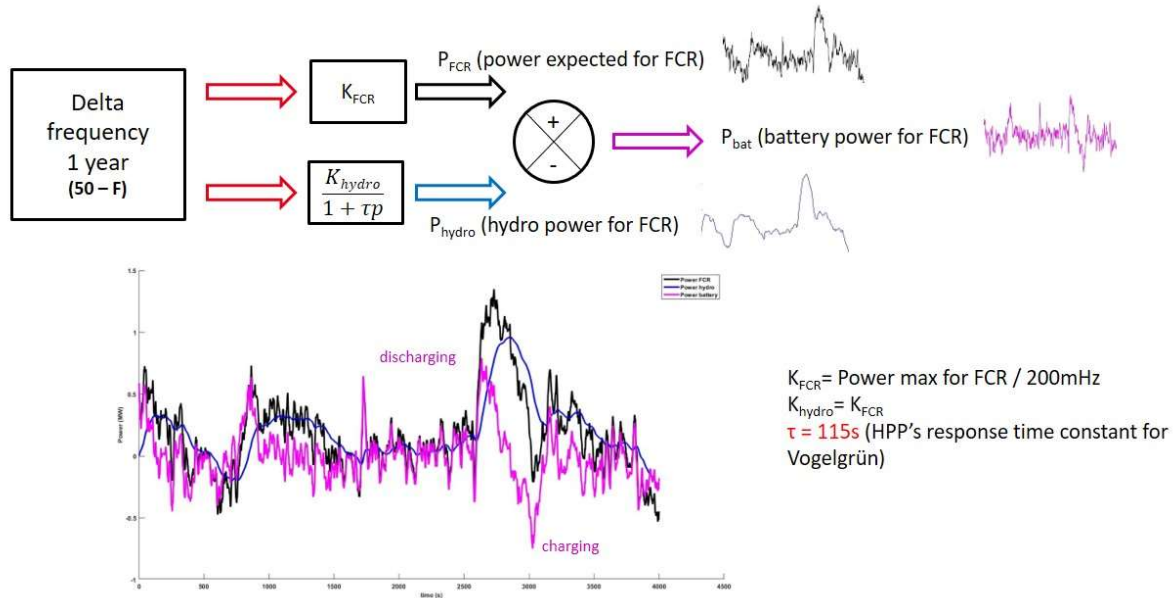

Figure 4: Power extraction methodology

Three powers are computed as described in Figure 4:

- The first, in black color, is the power expected by the TSO regarding the frequency deviation (denoted P_{FCR}). It's the frequency deviation from 50Hz times the FCR ratio (4MW/200mHz).
- The second, in blue color, is the power provided by the Hydro Power Plant (denoted P_{hydro}). This power is computed using a simple model of the Vogelgrun HPP based on a first order model. From qualification test and based on time step response of minus 200mHz frequency deviation, time constant response and static gain are identified.
- The third, in pink, is the power to be delivered by the battery so that the hybrid unit provides the power expected by the TSO. This power is the difference between P_{FCR} and P_{hydro} .

The second step deals with the optimum sizing of the storage system regarding power profile obtained previously. Firstly, a “Quantile” approach has been included in order to optimize the BESS parameters in term of power and energy, down to reasonable values. Secondly, several Key Performance Indicator (KPI) have been computed such as FCR coverage and battery ageing. These indicators computed from different battery's technologies and manufacturers helped to compare and select the solution within economic and technical constraints.

As mentioned in [11] results for this demonstrator highlight that a power of 650 kW (17% of total FCR supply) seems to be the best compromise between rating and required grid frequency support. In the same time, the Titanate battery technology shows very good ageing behavior for such application. However, the price per kWh is rather expensive. Manganese battery, especially rack system with NMC technology represent a relevant alternative as it is cheaper and ageing remains acceptable (after 2 years, it is expected 87% of State Of Health - SOH) with an initial energy tank of 400 kWh.

2.3. BESS modeling

Three different aging models have been used to simulate the capacity loss of the 3 different technologies and suppliers. These 3 aging models are empirical models based on aging tests performed at cell level

for different conditions. Although the results of the aging tests are different regarding the technologies, the architecture of the models follows the same principle for the 3 models. The objective of the battery aging models developed at CEA is to be able to predict the loss of capacity of a cell subjected to a given power profile (calendar storage or charge / discharge cycles) over a certain period of time. For this, the degradation law described below is defined and the parameters of this law are best adjusted to the available experimental data (loss of capacity as a function of time or of Ah transited) by the method of least squares.

The capacity loss of a battery cell, which degrades in calendar and / or cycling, can be partly explained by the growth of the layer of Solid Electrolyte Interphase (SEI). This growth is limited by ionic diffusion in the SEI [12].

In this approach, the rate of decrease in capacity can be expressed, in the case of calendar storage, by the following expression:

$$\frac{\partial Q_{loss}}{\partial t} = \frac{J_{cal}}{1 + A \cdot Q_{loss}}$$

Équation 1: Calendar capacity loss rate

With Q_{loss} , the capacity loss in Ah, J_{cal} , kinetic factor depending on cell's SOC level and cell's temperature and A , a constant factor.

For cycling aging, the degradation rate depends on the cell's charge quantity Q_{th} transited during battery use:

$$\frac{\partial Q_{loss}}{\partial Q_{th}} = J_{cyc}$$

Équation 2 : Cycling capacity loss rate

It is considered that during cycling periods, there is still a calendar contribution, which depends on the time spent. The capacity degradation law is then expressed as the sum of the two calendar + cycling contributions:

$$dQ_{loss} = \frac{\partial Q_{loss}}{\partial t} dt + \frac{\partial Q_{loss}}{\partial Q_{th}}$$

Équation 3 : Coupled model capacity loss rate

Depending on experimental results these degradation laws could be adapted.

Figure 5 and **Erreur ! Source du renvoi introuvable.** below show an example of model parameters calibration for calendar tests and cycling tests.

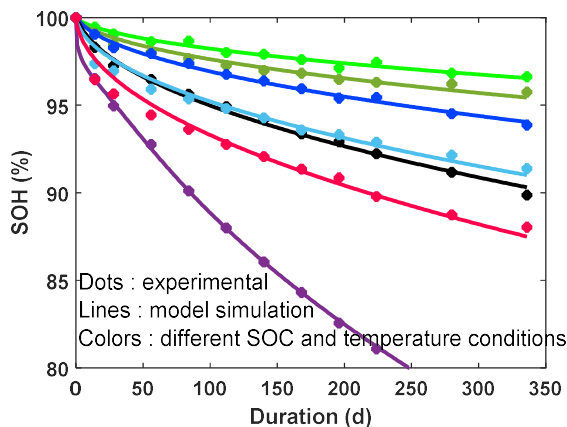

Figure 5 : Example of calendar aging test results and model simulation.

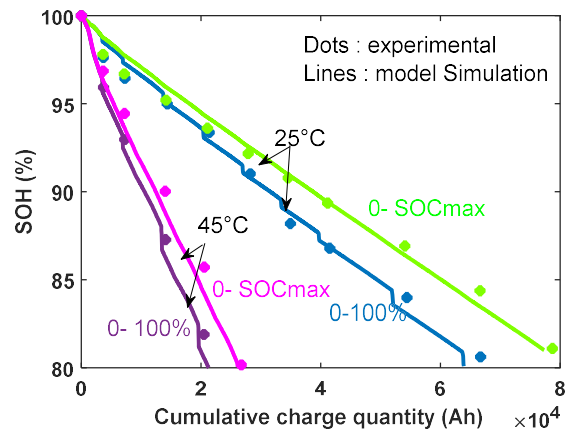

Figure 6 : Example of cycling aging test results and model simulation.

These laws are implemented in the Matlab/Simulink battery's model to make simulation. This model based on look up tables (LUT) represents the behavior of a cell in term of current, voltage and aging. For the demonstrator, the models parameters present in these LUT have been determined for the 3 different Li-ion cell's technologies in competition.

2.4. Control algorithm

Hybrid algorithm consists to control HPP and BESS power simultaneously. Indeed, at every moment the sum of these two powers on the grid, have to be consistent with FCR requirement regarding a given frequency deviation.

Figure 7 presents the control overview where grid frequency and BESS state of charge are the inputs of the algorithm and where BESS power and HPP frequency set point are the outputs. Historically the HPP's governor uses the frequency signal to modulate its generation based on droop value. The aim of the hybrid controller is to control the HPP's power through its governor thus keeping existing hardware. For this purpose, the hybrid controller recreates an analogic frequency signal to control hydro unit output. The hybrid control also embeds a SOC management described below.

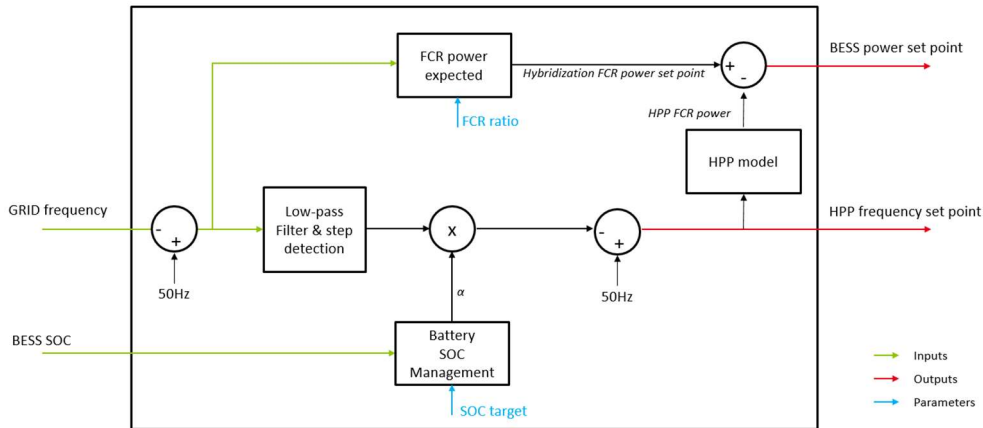

Figure 7: Control algorithm overview

1. HPP control is based on filtered grid frequency modulated with battery state of charge. The first bloc named “Low-pass Filter & step detection” is a first order low pass filter and creates the “smooth version” of the grid frequency signal. The time constant of this filter is set to 30s and was chosen to optimize FCR coverage and battery sizing. Finally, the filtered signal is modulated by the signal provided by the bloc named “battery SOC management”. Indeed, the DC power profile applied to the battery is not symmetrical in terms of energy hence BESS gets quickly depleted. SOC management addresses this issue so that the BESS operates around a SOC target. The strategy is to use energy provided by HPP to charge the BESS when the HPP is over the reference power.

2. BESS power set point is the difference between power required by FCR response (“Hybridization FCR power setpoint”) and the power provided by the HPP controlled with frequency signal from hybrid controller. Regulating power “Hybridization FCR power setpoint” is computed as the frequency deviation from 50Hz multiplied by a fixed ratio “FCR ratio” in MW/Hz. (4 MW/Hz). This simple model approximates the behavior of the HPP power response but the results are close to the reality.

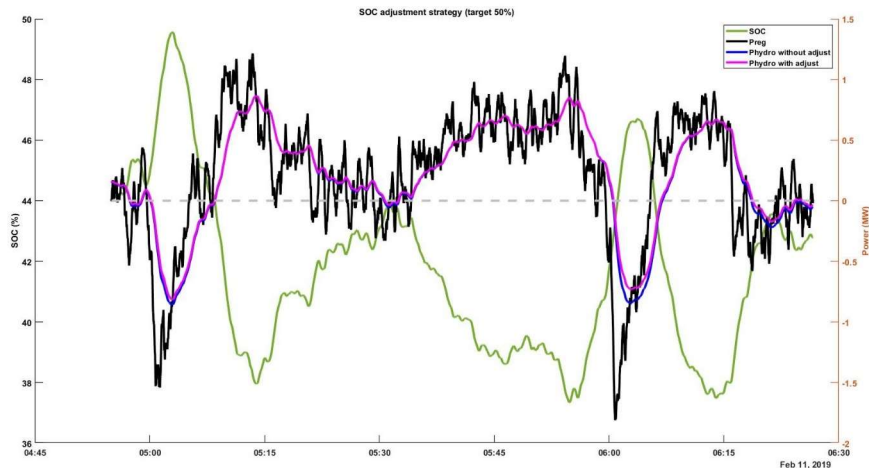

Figure 8: Simulation of BESS operation with SOC management

Considering the rules of SOC management bloc described previously, Figure 8 presents the behavior of the BESS SOC (curve green) during a frequency deviation. In case of over frequency (>50 Hz), the battery takes energy from the HPP if the SOC target is not reaching (50%). The SOC management strategy influence is visible where power set without adjustment (curve blue) and with adjustment (curve pink) are not overlapping.

2.5. Co-simulation

After the validation of the 1D numerical model, the SIMSEN file was coupled to the simulation model of the BESS and its controller in the SPIDER/Matlab simulation platform developed by CEA, see Figure 9. With the co-simulation, both simulation tools SIMSEN and SPIDER run in parallel and exchange predefined quantities at given exchange points in time. In particular, the power set point for the turbine governor comes from the BESS controller model in SPIDER, while the actual power produced by the turbine comes from SIMSEN.

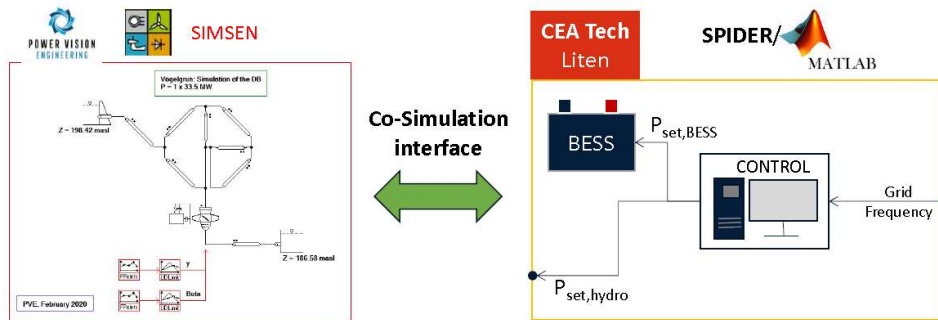

Figure 9 Co-simulation interface between SIMSEN and SPIDER.

The impact of the BESS for ancillary services is illustrated in Figure 10 with the assessment of the Frequency Containment Reserve (FCR). The technical requirements RTE in France impose an artificial injection of a -200 mHz frequency step at the speed controller. The power response must be delivered within 30s and respect the power limitation described by the red curve in Figure 10 (left). The battery compensates the adverse active power response occurring the first seconds after the grid frequency variation which is related to the non-minimum phase induced by the hydraulic system response.

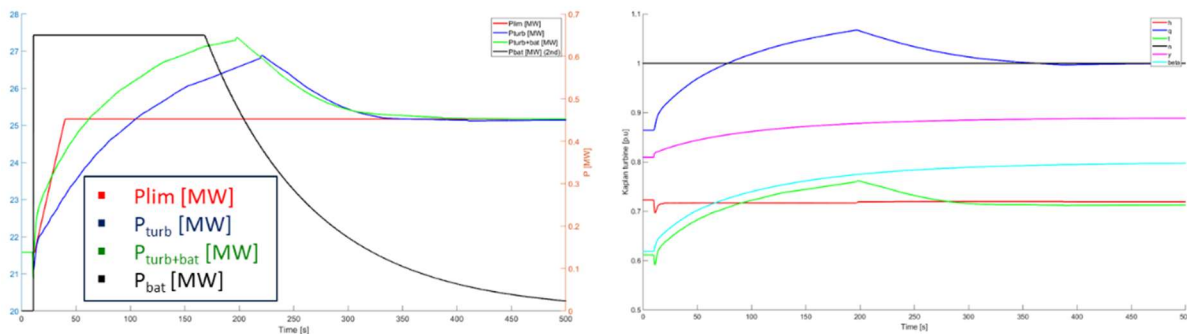

Figure 10 Power response after an injection of a -200 mHz frequency step (left) and the transient behavior of the Kaplan turbine (right).

3. Step forward for wear and tear reduction without compromising FCR provision

3.1. The Smart Power Plant Supervisor (SPPS)

Within the scope of the XFLEX HYDRO project, a digital tool named Smart Power Plant Supervisor (SPPS) is being developed. The SPPS integrates advanced hydroelectric technological solutions, including advanced monitoring, control and communication with all the hydropower plants functional levels. SPPS aims to increase reliability and lifespan of the units, together with ancillary services

provision to the power system. A schematic representation of the SPPS role in the HPP communication bus is illustrated in Figure 11, the complete description of this tool is detailed in [13].

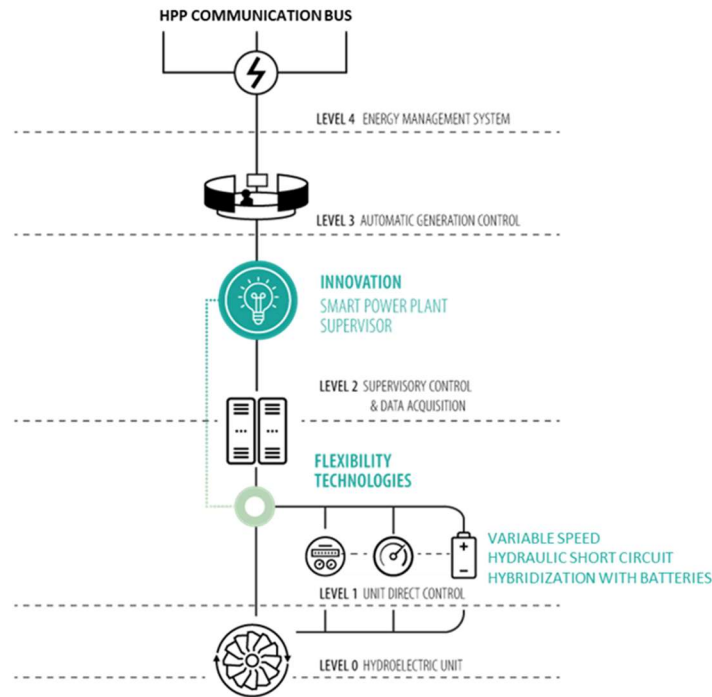

Figure 11 : HPP communication bus and SPPS interface

The implementation of the SPPS at the Vogelgrün RoR HPP has the following objectives: maximizing the provision of the Frequency Containment Reserve (FCR) to the power system, respecting the discharge set-point, maximizing the efficiency, and minimizing the mileage and the number of manoeuvres of the guide vanes and blades servomotors. A detailed description of the full framework and of the formulation of the optimization problem steering the advanced control can be found in [10] and [15]. These studies are discussing the operation of one of the four Vogelgrün units, where a droop-based control framework to enhance FCR provision is implemented. Efficiency and discharge of the unit are modelled as analytical functions representing the turbine behavior. Indeed, in order to include the machine behavior in an optimization problem, it is necessary to build the analytical and continuous functions of the efficiency and discharge as a function of the state variables head, opening angle of guide vanes and blades opening. Both efficiency and discharge are modelled as the sum of piece-wise cubic splines by implementing the multivariate regression method described in [10]. The data-set used to train the algorithm is built by collecting the turbine characteristics curves data and time history analysis over one-year operation. Moreover, the models are validated over one-month operation time history data of Vogelgrün RoR HPP. Both the efficiency and the discharge surrogate models provide accurate fits of the real machine characteristics, obtaining excellent results in terms of coefficient of determination, $R^2 = 0.9884$ and $R^2 = 0.9992$, respectively. The multidimensional hill-chart resulting from the integration of these meta-models is illustrated in Figure 12.

To increase the ability of the HPP in providing FCR, a second layer is added to the SPPS. This latter is responsible for computing the droop coefficient and for acting as the discharge manager. The control layer is responsible of forecasting the energy required for FCR provision over a time horizon of one hour, which is performed by implementing auto-regressive models [15]. Thanks to this prediction, the control can anticipate deviation in the machine discharge due to FCR provision and reduce the number of movements necessary to control the head of the river. The results showed that the developed advanced control can provide more regulating power while ensuring the system reliability for the discharge control. The deviation of the discharge from the given set-point, which is due to the provision of flexibility, is controlled by computing an offset discharge every hour. This also allows reducing the number of movements of the regulating components of the hydroelectric unit. This represents an

improvement for the standard control system that imposes continuous movements of guide vanes and blades to respect the discharge set-point.

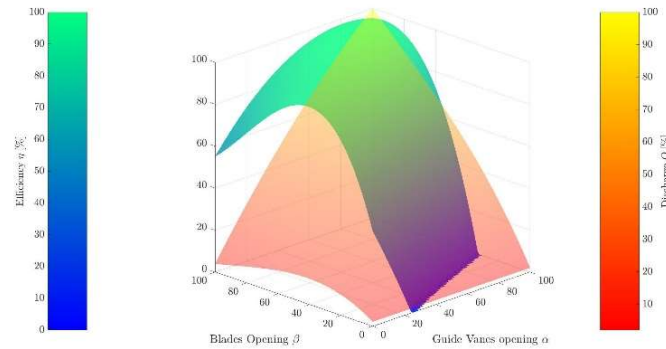

Figure 12 Two variables hill-chart of efficiency and discharge for Kaplan unit 1 at Vogelgrün RoR HPP at rated head.

Further development of this study includes the addition of meta-models of other variables, such as the accumulated damage due to the wear and tear, for which CFD, FEM and reduced scale model tests are currently being performed to achieve a sufficient database to train the modelling algorithm. This study will allow including the damage model in the solution of the optimization algorithm which is currently only limited by the number of movements of the servomotors.

3.2. Health Index assessment

As part of the demonstrator goal, Wear and Tear of turbine components is to be quantified in relationship to grid primary frequency control.

To achieve such assessment, the methodology is based on actual data acquired at site on the hybrid unit and on a sister unit (non hybrid). There, cumulated servo motor stroke (mileage) and sign changes and forces are to be compared.

Thanks to CFD model and FEM computation, site data help computing actual stress on components of the turbine and estimate fatigue life consumption.

In the same manner, actual site data and turbine CFD are to help determining blade bushing and seal pressure and thus associated wear. Estimated wear pattern applied to actual bushing material shall lead to life consumption.

On top of the comparison between two units of the same plant, the comparison shall also be made with a digital twin emulating the hybrid unit as if it were not thus providing a second comparison base to draw conclusions.

3.3. Hydro-Clone

The "Real-Time Simulation Monitoring" Hydro-Clone[®] system is based on a properly validated SIMSEN model of the hydropower plant under consideration and simulates the dynamic behavior of the plant from boundary conditions measured on site and transmitted to the numerical model via the SCADA system. The system has the capability to address several programmable logic controllers (PLC) in parallel using the Modbus TCP protocol, to drive the simulation with the appropriate measured boundary conditions, see Figure 13.

The purpose of the Hydro-Clone system is to detect and prevent equipment malfunctions or anomalies that could affect the hydraulic transients of a hydropower plant, to reduce the risk of major accidents that could jeopardize the integrity of facilities and people. The digital twin of the hydropower scheme gives access to quantities that are often difficult to measure, yet essential for the life of components such as pressure fluctuations along the waterway. Moreover, the comparison of measurements with simulated results makes it possible to identify premature malfunctions or event sequences that cause high loads on the equipment. The digital cloning approach allows advanced monitoring of transient phenomena and the detection of extreme events even before an admissible limit is exceeded. In the case of Vogelgrün

power plant, The Hydro-Clone system is used to survey the impact of BESS operation on the hydraulic transients with a particular focus on wear and tear.

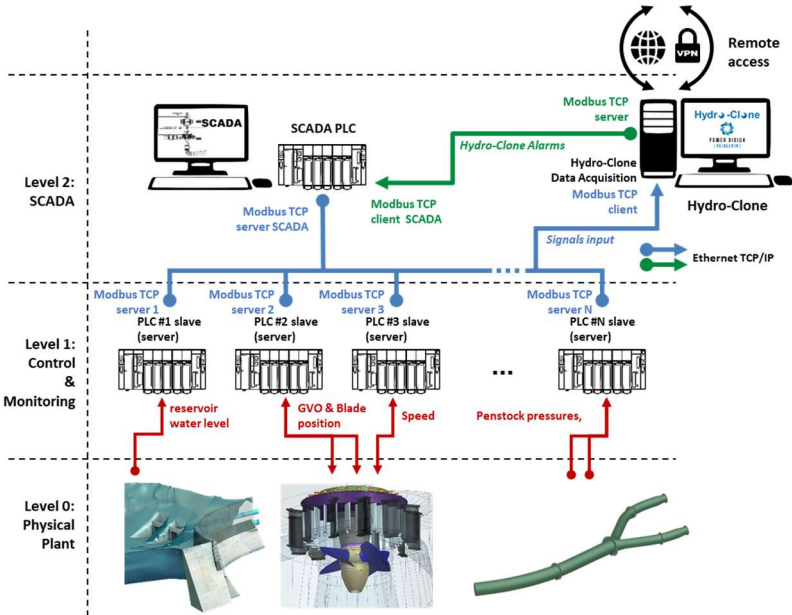

Figure 13 Schematic of the implementation of the Hydro-Clone in the measurement chain and architecture of the Modbus TCP network for data exchange.

4. Conclusion and perspective

The micro hybrid concept shows high added value perspective. Actual numbers are expected from the demonstrator put online at Vogelgrün Run of River plant since mid 2021.

This in situ, industrial scale demonstrator will show how Run of River plant, which are often targeted for their lack of flexibility, can still provide grid support (grid frequency primary control) together with an improved life expectancy of mechanical parts. The hybrid demonstrator therefore intends to solve this equation: “*more service, with less; less wear and tear and less battery*”, by using a small size battery which will work in tandem with the original hydraulic unit. The Vogelgrün demonstrator feature is different from what has been implemented in other areas, where the whole primary control is transferred to the battery, meaning a large, raw material hungry and expensive battery is required.

Micro hybrid concept innovation lies in the motto that less battery together with less hydro unit fatigue provides more grid service.

To achieve this ambitious goal, a control algorithm has been developed with project partners and has been implemented in a controller hardware. The behavior of the hybrid hydro unit has been simulated thanks to a numerical model running on SIMSEN software.

Considering fatigue of mechanical parts, a 3D model of the turbine has been created to assess and rank through FEM analysis, the most critical components.

To quantify wear and tear stress, the hybrid unit, together with a regular sister unit which serves as reference, have been equipped, with dedicated sensors and online monitoring. Data acquired during real unit operation are to provide genuine data about stress in components and from there, will help assessing the maintenance gain on the hybrid unit.

***Acknowledgement** : authors would like to acknowledge the contribution of the European Union to the XFLEX Hydro project, which has received funding from the Horizon 2020 research and innovation program under grant agreement No 857832*

BIBLIOGRAPHY

- [1] European Commission, “Energy Roadmap 2050 Brochure,” Publications Office of the European Union, 2012
- [2] Batcave project by FORTUM ; <https://www.fortum.com/>
- [3] BP Statistical Review of World Energy & Ember
- [4] Flexibility, technologies and scenarios for hydropower”; sept 2020; <https://ec.europa.eu/>
- [5] Sick, M., Michler, W., Winkler, S., Wurm, E., Désy, N., Coutu, A., Flexible tubrine operation enabling frequency control, Proceedings of HYDRO 2012, October 29-31, 2012, in Bilbao, Spain, Paper 04b.14.
- [6] Weijia Yang, Per Norrlund, Linn Saarinen, Jiandong Yang, Wencheng Guo, Wei Zeng, Wear and tear on hydro power turbines – Influence from primary frequency control, Renewable Energy, Volume 87, Part 1, 2016, Pages 88-95, ISSN 0960-1481, <https://doi.org/10.1016/j.renene.2015.10.009>.
- [7] L. Saarinen, P. Norrlund, W. Yang and U. Lundin, "Allocation of Frequency Control Reserves and Its Impact on Wear and Tear on a Hydropower Fleet," in IEEE Transactions on Power Systems, vol. 33, no. 1, pp. 430-439, Jan. 2018, doi: 10.1109/TPWRS.2017.2702280.
- [8] NICOLET, C., Hydroacoustic Modelling and Numerical Simulation of Unsteady Operation of Hydroelectric Systems, PhD Thesis, EPFL n°3751, Lausanne, 2007.
- [9] NICOLET, C., DREYER, M., BEGUIN, A., BOLLAERT, E., TORRENT, S., DAYER, J.-D., Hydraulic Transient Survey at Cleuson-Dixence with Real-Time Hydro-Clone Monitoring System, Proc. of HYDRO 2018 Conference, October 15-17, 2018, in Gdansk, Poland, Paper 25.02.
- [10] F. Gerini, E. Vagnoni, R. Cherkaoui and M. Paolone, "Optimal CAM Computation of Kaplan Turbines Accounting for Wear and Tear Originated by Frequency Control," 2021 IEEE Madrid PowerTech, 2021, pp. 1-6, doi: 10.1109/PowerTech46648.2021.9495080.
- [11] G. Païs, L. Vinit, T. Delaplagne, M. Montaru, J.L. Drommi, “Hydro power plant hybridization with battery energy storage system for primary frequency control”, 5Th International Hybrid Power Systems Workshop. (18-19 may 2021)
- [12] A. Barré, B. Deguilhem, S. Grolleau, M. Gérard, F. Suard, et al., “A review on lithium-ion battery ageing mechanisms and estimations for automotive applications”. Journal of Power Sources, Elsevier, 241, pp. 680 – 689, 2013.
- [13] E. Vagnoni, F. Gerini, R. Cherkaoui, M. Paolone, 2021, Digitalization in hydropower generation: development and numerical validation of a model-based Smart Power Plant Supervisor, Vol. 774, 012107, 30th IAHR Symposium on Hydraulic Machinery and Systems, <https://dx.doi.org/10.1088/1755-1315/774/1/012107>.
- [14] F. Gerini, E. idem 10
- [15] F. Gerini, E. Vagnoni, R. Cherkaoui, M. Paolone, 2021, Improving Frequency Containment Reserve Provision in Run-of-River Hydropower Plant, accepted for publication in Sustainable Energy, Grids and Networks, Elsevier.