



HAL
open science

Assessment of the operation safety margin of the HL-LHC superconducting recombination Dipole D2 in case of helium filling failure

Bernard Rousset, F Bancel, N Besson, M Bon-Mardion, S Claudet, T Goy, Francois Millet, P Nivelon, A Perin

► To cite this version:

Bernard Rousset, F Bancel, N Besson, M Bon-Mardion, S Claudet, et al.. Assessment of the operation safety margin of the HL-LHC superconducting recombination Dipole D2 in case of helium filling failure. IOP Conference Series: Materials Science and Engineering, 2022, 1240 (1), pp.012121. 10.1088/1757-899X/1240/1/012121 . cea-04818281

HAL Id: cea-04818281

<https://cea.hal.science/cea-04818281v1>

Submitted on 4 Dec 2024

HAL is a multi-disciplinary open access archive for the deposit and dissemination of scientific research documents, whether they are published or not. The documents may come from teaching and research institutions in France or abroad, or from public or private research centers.

L'archive ouverte pluridisciplinaire **HAL**, est destinée au dépôt et à la diffusion de documents scientifiques de niveau recherche, publiés ou non, émanant des établissements d'enseignement et de recherche français ou étrangers, des laboratoires publics ou privés.



Distributed under a Creative Commons Attribution 4.0 International License

Assessment of the operation safety margin of the HL-LHC superconducting recombination Dipole D2 in case of helium filling failure

B Rousset¹, F Bancel¹, N Besson¹, M Bon-Mardion¹, S Claudet², T Goy¹, F Millet¹, P Nivelon¹, A Perin²

¹ Univ. Grenoble Alpes, CEA IRIG-DSBT, F-38000 Grenoble, France

² CERN, CH-1211 Geneva 23, Switzerland

bernard.rousset@cea.fr

Abstract. After the successful completion of the cryogenic performance tests of the He II heat exchanger prototype for the D2 recombination dipole of the future HL-LHC project at CERN, specific measurements were performed to determine the operation safety margin in case of abnormal operating conditions. This is particularly relevant in case of the failure of liquid helium supply in the He II cold source. For nominal operation, the liquid level is regulated at a constant value and it is not necessary to know its value very accurately. However, in case of a partial drying of the heat exchanger due to discontinuation of the helium liquid supply, it is essential to monitor the absolute value of the liquid level to anticipate any cooling malfunction. This paper describes the procedure for an accurate in-situ He II level measurement as well as for the heat loss and mass flow rate estimates in a He II phase separator. The operation safety margins of the He II heat exchanger prototype for the D2 magnet are then analyzed for the different operating conditions considered during the HL-LHC runs in case of non-nominal liquid level in the He II cold source.

1. Introduction

In the coming years, several LHC superconducting magnets in the long straight sections of IP1 and IP5 of LHC will be replaced in the framework of the High Luminosity Upgrade of the LHC (HL-LHC). Among them, the D2 recombination dipole magnet is under its design qualification phase. Its superfluid helium cooling system has been studied [1] and a compact pressurized He II / saturated He II heat exchanger was selected as reference cooling option [2]. A heat exchanger prototype shown in figure 1 was built and tested in the 400W@1.8K test facility at CEA-Grenoble [3].

The heat exchanger prototype is made of about one hundred oxygen-free high purity copper tubes (OFE copper tubes, 500 mm long, 10 mm internal diameter, 1 mm thick), electron beam welded to stainless steel flanges in the saturated He II bath enclosure. In its final configuration, the heat exchanger will be connected to the D2 magnet while for the cryogenic qualification tests, the prototype was welded to an instrumented test cell simulating the D2 magnet conditions (pressurized He II bath with variable heat loads). The cryogenic performance in steady state operating modes were measured at different operating conditions and are detailed in a companion paper [4]. As a summary, the measured temperature differences in the heat exchanger prototype with 70 W injected heating power are lower than 20 mK at 2 K and lower than 25 mK at 1.8 K, far below the specified thermal requirements of respectively 54 mK and 220 mK.



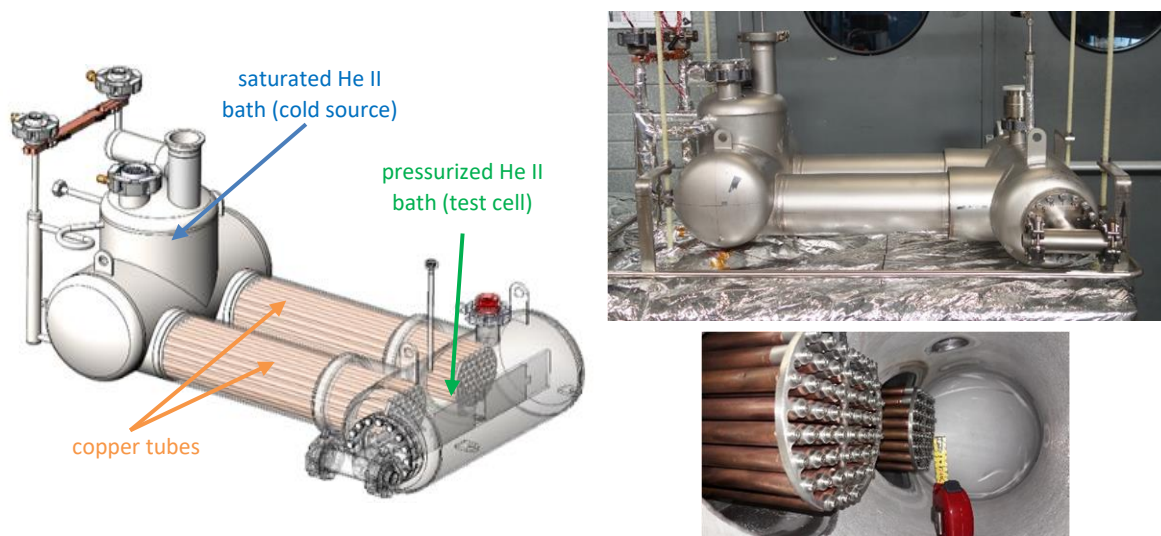

Figure 1. Overview (left) and external and internal pictures of the heat exchanger prototype (right)

In addition to the steady-state performance validation, complementary cryogenic measurements were also performed to assess the operation safety margins in case of abnormal operating conditions. In this paper, we present the test results in case of helium liquid supply failure and the specific testing procedure and instrumentation checking to achieve accurate measurements.

2. Test facility and instrumentation description

The Helium refrigerator of the 400W@1.8K test facility offers a large operational flexibility with a cooling capacity greater than 100 W from 4.2 K to 1.5 K [3]. This is perfectly adapted for the heat exchanger qualification tests performed at different operating conditions and heat loads. Additionally, the large Multi-Test Cryostat of the test facility provides a useful tool to install the heat exchanger prototype and its test cell in the required configuration. To simulate the future D2 magnet operation in the HL-LHC, the heat exchanger prototype and its test cell were fixed with a slope of +1.4% corresponding to the worst case of the tunnel configuration.

Specific instrumentation (temperature, pressure, liquid level, massflow), electrical heaters and cryogenic valves are also present in the test facility to control the cryogenic tests and measure the heat exchanger performances. Figure 2 presents the Process Flow Diagram (PFD) of the heat exchanger prototype (HX-D2) in the test configuration.

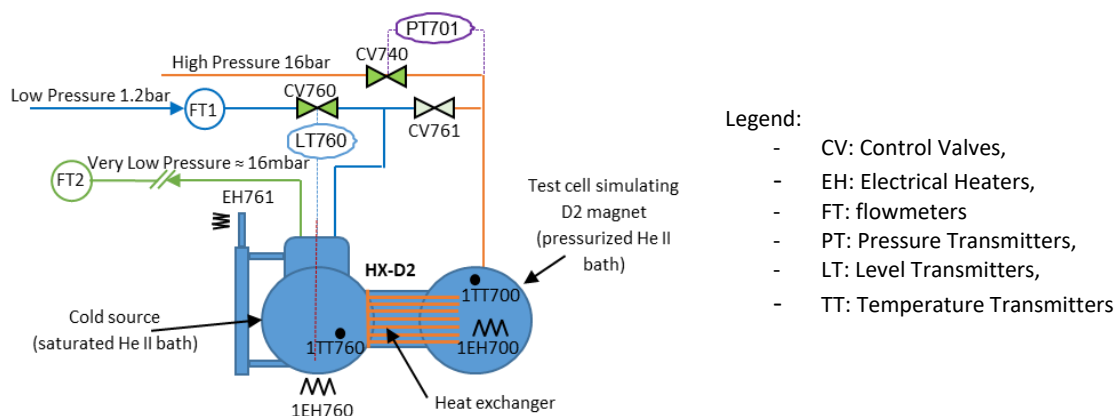

Figure 2. Process Flow Diagram for the HX-D2 heat exchanger prototype testing

The assessment of the heat exchanger cryogenic performances in normal and abnormal conditions were achieved by measuring the temperature difference across the heat exchanger for a defined heat flux applied in the test cell. To do so, the temperature difference between the pressurized He II and saturated He II baths is measured using respectively the temperature sensors 1TT700 and 1TT760 and the electrical heater 1EH700 in figure 2. The immersion depth is measured and controlled using superconducting liquid level probes (LT760). Furthermore, the inlet mass flow rate to fill the saturated part of the heat exchanger is measured via a Coriolis flowmeter FT1 located at low temperature, just before the Joule Thomson valve (CV760). The outlet mass flowrate is measured via a Venturi flowmeter FT2 at room temperature in the warm compression station.

3. Instrumentation checking

3.1. Heat losses estimation

Before any performance measurement, it is important to have an estimate of the heat losses on the pressurized He II part of the heat exchanger because it directly contributes to the temperature difference in the heat exchanger.

To access to the total heat losses P_{losses} on the heat exchanger, one could isolate it from the liquid supply line by closing the JT valve CV760 which supplies the He II saturated bath. Then one has to record the level decrease and, knowing the corresponding evaporated volume, one can calculate the heat losses. As an alternative option, in the 400W@1.8K test facility instrumented with flowmeters, one can also use the vapor mass flow measurement to estimate the total heat losses.

It is worth mentioning that the vapor mass flowmeter (outlet flowrate FT2) was compared to the Coriolis flowmeter (inlet flowrate FT1) for different injected heating powers while keeping constant liquid level in the saturated He II bath. The vapor mass flowmeter is a Venturi one and its accuracy is consequently better at large flows. The experimental results show very good agreement and give confidence in the measurement accuracy of the flowmeters.

To minimize measurement uncertainties, it is more efficient to add different imposed heating powers to the heat losses, then to plot the injected heating powers versus the corresponding vapor mass flows, and finally to extract the heat losses P_{losses} as the abscissa value at the origin of the resulting fitted curve as illustrated in figure 3.

With no liquid filling (JT valve CV760 closed), the relation linking the vapor mass flow \dot{m}_v (measured in FT2) and the injected heating power P (e.g. 1EH700) should follow Equation (1).

$$P = \dot{m}_v \frac{\rho_l}{\rho_l - \rho_v} L_{sat} - P_{losses} \quad (1)$$

where ρ_l and ρ_v are respectively the liquid and vapor densities and L_{sat} the latent heat.

One should note that the term $\frac{\rho_l}{\rho_l - \rho_v}$ accounts for the vapor volume replacing the evaporated liquid volume inside the bath (this vapor volume will not contribute to vapor mass flow as it stays inside the bath). Figure 3 presents the heating power P as a function of the corrected evaporated liquid mass flow $\dot{m}_v \frac{\rho_l}{\rho_l - \rho_v}$ and shows the predicted linear behavior expressed in Equation (1). The slope corresponds to the latent heat L_{sat} (23.42 J/g according to helium properties (HEPAK [6]) and 23.50 J/g computed from the best linear fit presented in figure 3) and the heat losses should correspond to the abscissa at the origin, i.e. 10.9 W in the presented tests.

These 11 W heat losses are deposited on the overall heat exchanger prototype including its test cell. A preliminary rough estimate consists to attribute half of this value to the He II pressurized side (test cell) and the remaining one to the He II saturated bath (cold source).

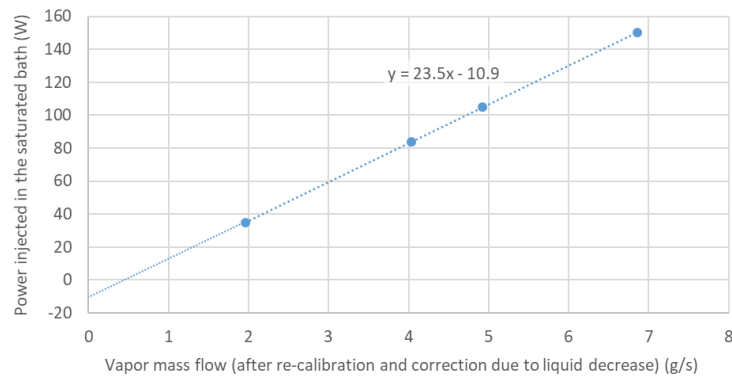

Figure 3. Total heat losses estimation of the prototype at 2 K

3.2. Liquid level probe calibration

The liquid level in the He II saturated bath is measured thanks to commercial superconducting probes. The in-situ calibration is required for accurate absolute level measurements to assess the operating safety margin of the heat exchanger in case of discontinuation in liquid helium supply. Exact location of the extremities of the superconducting part inside the heat exchanger is therefore mandatory and this requires in situ calibration. To do so, the following procedure was applied.

First, it is important to note that the cross section of the He II saturated part of the heat exchanger is very complex and depends on the level. As illustrated in figure 4, the heat exchanger geometry starts at its bottom with three horizontal cylindrical enclosures including two parallel quasi-horizontal cylinders (here inclined at 1.4%) containing the heat exchanger copper tubes. Figure 4 shows also the liquid level as a function of the He II saturated bath volume calculated from the fabrication drawings. Due to the material thermal contraction (0.33% from room temperature down to superfluid helium temperature for stainless steel), a coefficient of 0.99 (1%) must be applied to the calculated room temperature volume to correctly estimate the “real” bath volume at cryogenic temperature.

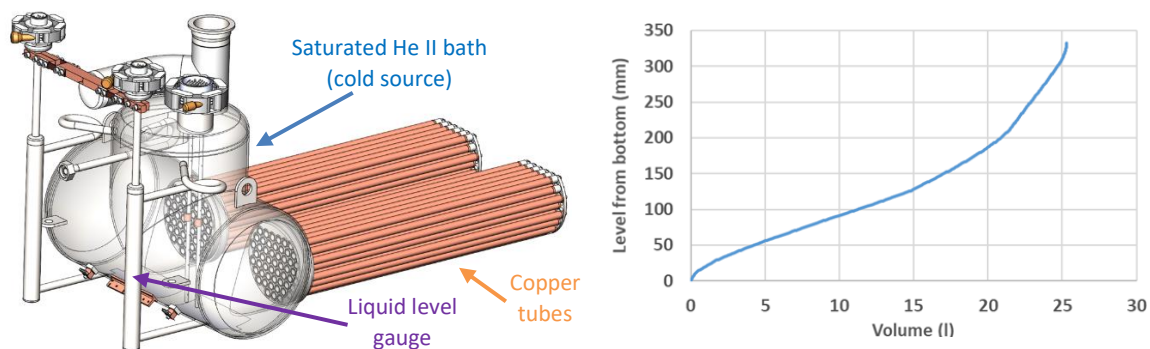

Figure 4. Overview of the heat exchanger prototype (left) and liquid level evolution versus liquid volume (right) in the He II saturated bath with test configuration inclined at 1.4%

To calibrate the liquid level probe, which has a linear response, we used the liquid level probe output in percentage given by the conditioner and converted it in real unit, e.g. millimeters. Different experiments were performed with either constant increase or constant decrease of the liquid volume inside the He II saturated part of the heat exchanger. For each of them, we compared the liquid volume inside the He II saturated bath calculated from the difference between inlet and outlet bath mass flow rates and the liquid volume given by the superconducting level probe measurement itself using figure 4 (liquid level versus liquid volume) and the cryogenic temperature correction. We then looked at the best fit with the position of the liquid probe (offset) and its scaling (number of millimeters per percent) as free parameters. Finally, we defined the best linear coefficient of the level probe (converting percentage

of probe immersion to absolute liquid level in mm). Due to the complicated geometry of the bath (horizontal and vertical tubes), a linear variation of volume induced by constant mass flowrates does not correspond to a linear evolution of the liquid level, which helps in finding the offset without ambiguity.

Knowing the difference between inlet and outlet mass flows, one can calculate the amount of liquid inside the bath as a function of time, so it is easy to plot theoretical increase of liquid level coming from zero (empty bath) up to the maximum value (all bath filled with liquid).

During experiments, only a portion of the bath volume is covered and a linear fit is used to find offset and span to match the liquid level probe measurements with the theoretical curve. The whole range of the level probe was not covered, as there are always some transients before reaching steady state conditions. Starting with a low regulated level, the increase of the JT valve opening does not only increase the liquid level but also the returning vapor mass flow, mainly due to the flash evolution. To keep the bath temperature constant, this increase in the vapor mass flow must be compensated by the pumping capacity of the test facility. In addition, to avoid the risk of liquid droplets entrainment, we kept the level well below the top of the heat exchanger. The same precautions were applied for the decreasing level procedure (decreasing the JT valve opening starting with a high liquid level).

Figure 5 shows the results of the in-situ calibration with the best linear coefficient found for the liquid level probe from Equation (2).

$$\text{Liquid Level (mm)} = 2.425 \times \text{reading (\%)} + 35.3 \quad (2)$$

It should be noticed that this calibration value is very close to the expected values. Indeed, the sensitivity of 2.425 mm/% is similar to the value given by the supplier (0.1 inch/%). The 35 mm offset is also consistent with the level probe location outside the bath and connected to it via a tube arriving just above the bottom of the main bath cylindrical portion (see figure 4).

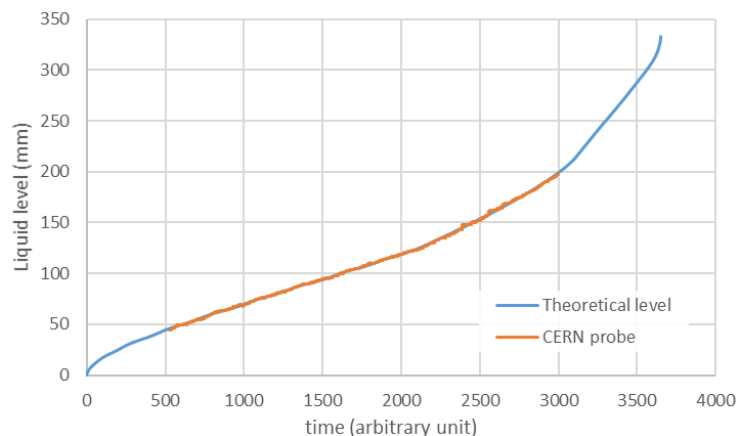

Figure 5. Liquid level comparison between the fabrication drawings and the cryogenic measurements

4. Operating safety margin tests and analysis

The heat exchanger prototype was first tested in steady-state operation modes to validate its specified cryogenic performances as summarized in [4]. These steady-state tests confirm the efficient compact design of the heat exchanger offering significant operating margins with 70 W injected heating power (nominal D2 magnets) either at 1.8 K or 2 K. In complement to this steady-state validation, one should also assess the ability of the heat exchanger prototype to operate in abnormal scenarios and in particular with a partial immersion.

Indeed, partial drying out may occur in the event of a failure corresponding to a sudden closure of the JT valve or degraded conditions in liquid helium supply (larger gas fraction for instance), as the

He II saturated bath is no longer filled properly. The time before reaching $T\lambda$ at the hottest point in the magnet depends on the available temperature margin.

This margin is present in the D2 magnet design in two ways. Firstly, due to the relatively high specific heat of superfluid helium and the inventory of the He II pressurized inside the magnet itself, a reservoir of enthalpy exists in the magnet and gives time to react. Secondly, the evaporation of liquid helium in the He II saturated bath (cold source) until reaching the minimal liquid level (no more temperature margin) gives an additional delay before the transition to normal helium appears in the warmest part of the magnet.

4.1. Enthalpy reservoir in the D2 magnet

A rough estimate of the time equivalent to the enthalpy storage available inside the magnet is given by Equation (3):

$$t = \frac{M(H_2 - H_1)}{W} \quad (3)$$

where M is the superfluid helium mass inside the D2 magnet, W is the heat loads deposited on the D2 magnet, H_1 is the initial average enthalpy along the magnet, i.e. the enthalpy corresponding to the superfluid helium pressure and the average temperature along the magnet, and H_2 is the ultimate enthalpy for the same pressure and an average temperature taking into account the available margin until reaching $T\lambda$ at the warmest point in the D2 magnet.

Applying Equation (3) for the D2 magnet operating with a 400 liters inventory of He II pressurized at 1.3 bar, using a cold source at 1.8 K and 70 W heat loads allows 15 min as equivalent time before reaching $T\lambda$. Similarly, operating the D2 magnet with a degraded cold source at 2.0 K reduces the equivalent time before reaching $T\lambda$ to 3.5 min.

4.2. Liquid level margin in the D2 cold source

In addition to the enthalpy reservoir, the time corresponding to liquid helium evaporation inside the cold source (and consequently partial de-wetting of the heat exchanger) was experimentally assessed during the cryogenic tests of the heat exchanger prototype. For testing safety reasons, the partial immersion tests were only performed at 1.3 bar, the nominal D2 magnet pressure, in the He II pressurized part and not at 4 bar, a degraded D2 pressure. This is required to limit the risk of overpressure during extreme dry out operations.

To be conservative, we neglected the additional heat losses (roughly 6 W according to estimation presented in section 3.1) and measured the heat exchanger behavior at the D2 heat loads (70 W). All points were performed in steady state conditions where the liquid level was regulated at a constant value before temperature measurements recording.

Figure 6 shows the measured temperature difference as a function of the liquid level in the He II saturated bath regulated at 2 K with 70 W injected heating power in the He II pressurized bath at 1.3 bar. A cross-section view of the heat exchanger prototype illustrates the corresponding positions of the main components of the He II saturated bath (gaseous helium pumping, liquid helium supply, copper tubes, and liquid level gauge). The origin of the y-axis (0 mm) corresponds to the lowest achievable liquid level in the He II saturated bath. Above 130 mm, all copper tubes are totally immersed in the saturated liquid He II.

As shown in figure 6, the “*minimal allowable level*” corresponds to the measured liquid level when the measured temperature difference across the heat exchanger reaches the CERN specification at 54 mK at 2 K. The “*maximal regulated level*” is defined as the maximal measurable liquid level with the installed level probe length (0-100%) keeping regulation margin. Finally, the 190 mm height corresponds to the 64% level probe reading which was the “*nominal level set-point*” regulated during all thermal performance tests reported in [4]. This nominal level set point at 190 mm was fixed during the design study to guarantee the sufficient immersion of all the copper tubes (+140 mm) plus an additional level height (+50 mm) for regulation tuning.

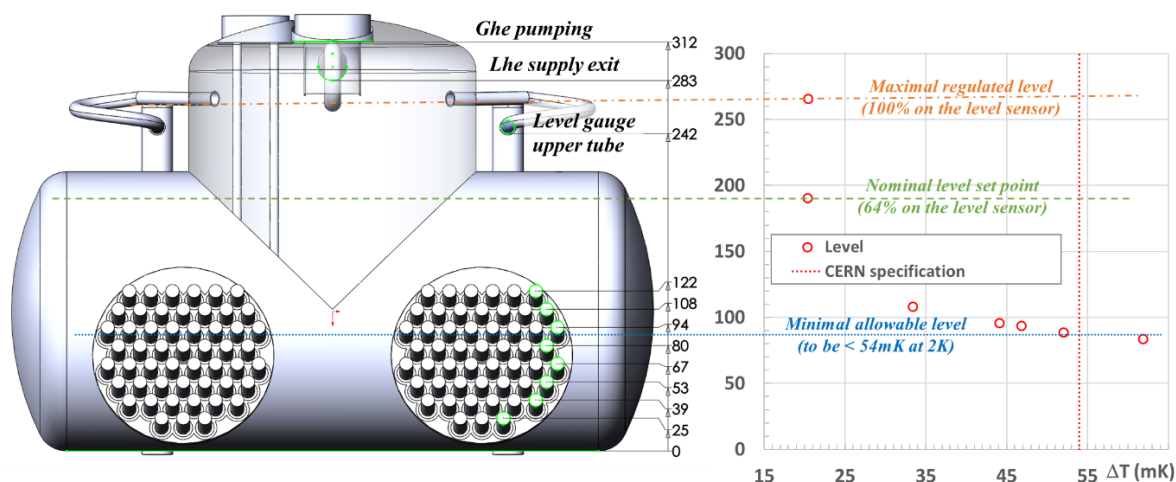

Figure 6. Cross-section of the heat exchanger prototype (right) and temperature difference at 2 K and 1.3 bar versus liquid level (in mm) in the saturated bath with 70 W injected heating power (right).

One can observe in figure 6 that increasing the liquid level above 190 mm at constant heating power has no effect on the observed temperature difference across the heat exchanger prototype. In fact, it very slightly increases the temperature difference as foreseen, due to the very small ΔT evolution inside the liquid height up to the liquid-vapor interface in the He II saturated bath.

During the level tests, we also demonstrated the ability of the heat exchanger prototype to operate at very high levels without detectable liquid droplet entrainment inside the vapor flow, a characteristic enabled by the specific design at the liquid supply and gaseous pumping interfaces. Figure 6 shows that the measured temperature difference changes rapidly as soon as the liquid level reaches the first copper tubes row around 120 mm.

Finally, figure 7 (left) presents the same measurements for the He II saturated bath regulated at 1.8 K for 70 W injected heating power in the He II pressurized bath at 1.4 bar (CERN specification – 220 mK). Figure 7 (right) presents also the measured temperature difference according to the liquid volume in the He II saturated bath.

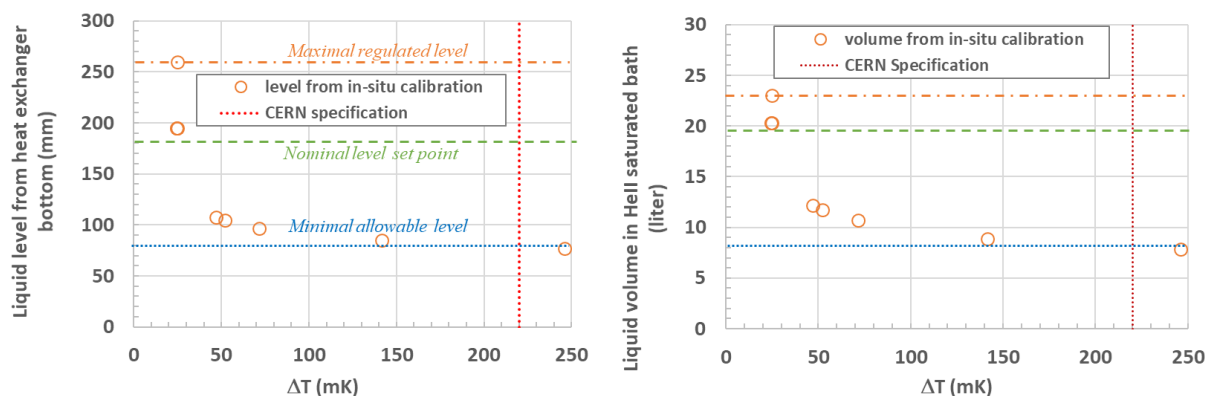

Figure 7. Temperature difference at 1.8 K and 1.4 bar versus liquid level in the saturated bath with 70W heating power injected in the pressurized bath (left) and temperature difference versus He II saturated bath volume (right)

In both figure 6 and figure 7, one can observe that a significant operating margin (> 100 mm) exists for the He II liquid level control at 1.8 K and 2 K with respect to the nominal level (190 mm) (i.e. to provide sufficient immersion of the necessary copper tube heat transfer surface in the heat exchanger prototype). For both 1.8 K and 2 K saturated cold source temperatures, the measured temperature

differences across the heat exchanger prototype stay lower than the maximal allowable limit down to a liquid level around 90 mm. This minimal height corresponds to the liquid emptying of the first two upper rows of the copper tubes as shown in figure 6.

As a conclusion, the observed dry out results show large operating margins in both liquid level and liquid volume. The liquid level could also be safely regulated up to a level of 250 mm with a temperature difference around 20-25 mK far lower than the specified ones. Such high liquid level regulation would be beneficial to prevent any issue during temporary stop of the liquid supply. The liquid level could also drop down to 90 mm. Consequently, the volume could vary from 20.2 liters to 9 liters.

For the future HL-LHC operations, the observed liquid level and volume operation ranges (more than 100 mm in level and 11 liters in volume) in the heat exchanger associated with the present “enthalpy reservoir” in the pressurized bath of the D2 magnets allow additional time to safely operate the D2 magnets if the liquid helium supply is interrupted (JT valve closing or warmer supply temperature). For 70 W injected heat loads and an initial nominal liquid level (not maximal), the additional times are 8.4 min at 2 K (much larger than the 3.5 min due to specific heat of pressurized He II in D2 magnet) and 9.7 min at 1.8 K (comparable with the 15 min found for the pressurized He II).

5. Conclusion

The present paper reports the assessment of the operating safety margin in abnormal scenarios of the compact He II-He II heat exchanger prototype for HL-LHC recombination dipoles D2. These specific cryogenic tests complete the cryogenic performance tests in steady-state operation modes [3]. In situ calibrations and specific test procedures were performed to obtain the maximal accuracy on the sensors and in particular the liquid level probe during these abnormal condition studies. The cryogenic tests focused on the measurements of the operating safety margins for the D2 heat exchanger in case of a failure on the liquid helium supply, leading to a partial drying of the heat exchanger tubes.

In the worst cooling case, with 70 W injected heating power from the D2 magnet side (He II pressurized bath) and the cold source operating at 2 K (He II saturated bath), the temperature difference in the heat exchanger remains below the specified value during partial drying of the heat exchanger down to 100mm liquid level decrease from the regulated one.

This promising result associated with the “enthalpy reservoir” in the He II pressurized bath would offer more than 10 minutes of cryogenically safe operation for the D2 magnet in case of a failure of liquid helium supply. This time could be used to adapt the HL-LHC operation (beam dump and magnet current deramping) if needed.

6. References

- [1] Rousset B, Millet F. Evaluation of Superfluid Helium Cooling Schemes and Application for HL-LHC Recombination Dipole D2. *Cryogenics* 2018, <https://doi.org/10.1016/j.cryogenics.2018.08.004>
- [2] Rousset B *et al.* Superfluid Helium cooling and compact Heat Exchanger for HL-LHC D2 Recombination Dipoles, 2019 *IOP Conf. Ser.: Mater. Sci. Eng.* **502** 012114
- [3] Roussel P *et al.* The 400W at 1.8K Test Facility at CEA-Grenoble. *AIP Conference Proceedings* 2006 823:1, 1420-1427
- [4] Rousset B *et al.*, Cryogenic Performances of a Heat Exchanger Prototype Suitable for the Superconducting HL-LHC Recombination Dipole D2, presented at this conference, 2021
- [5] Rousset B *et al.*, Superfluid High REynolds von Karman experiment, *Rev. Sci. Instrum.* **85**, 103908 (2014).
- [6] Arp V, McCarty B, Fox J. HEPAK. Cryodata Inc.; 1998.

Acknowledgments

This work is performed in the Framework Collaboration Agreement KN3573/GEN between CERN and CEA and its Addendum n°2 KE3800 for the design and qualification of the superfluid helium cooling of the recombination dipole D2 for the HL-LHC project.