



HAL
open science

In-memory computing low level programming model and amp; Compiler innovation

Henri-Pierre Charles

► **To cite this version:**

Henri-Pierre Charles. In-memory computing low level programming model and amp; Compiler innovation. MSC 2024 - International Workshop on Memory and Storage Computing, Sep 2024, Raleigh, United States. cea-04799431

HAL Id: cea-04799431

<https://cea.hal.science/cea-04799431v1>

Submitted on 22 Nov 2024

HAL is a multi-disciplinary open access archive for the deposit and dissemination of scientific research documents, whether they are published or not. The documents may come from teaching and research institutions in France or abroad, or from public or private research centers.

L'archive ouverte pluridisciplinaire **HAL**, est destinée au dépôt et à la diffusion de documents scientifiques de niveau recherche, publiés ou non, émanant des établissements d'enseignement et de recherche français ou étrangers, des laboratoires publics ou privés.

In-memory Computing Low Level Programming Model & Compiler Innovation

or “What is a compiler support for IMC accelerator”
Pearls on Tool Chains of In-memory Computing
MSC@ESWEEK 2024

Henri-Pierre CHARLES

CEA DSCIN department / Grenoble

Thursday, October 3



Introduction : Amhdal Law's ?

Ahmdal law's: "Speedup is limited by the sequential part"

- Acceleration limited by the "X" part : $S = \frac{1}{1-p}$
- $X \in \{\text{Parallel, Vectorized, using IP bloc, ...}\}$

Programmer approach

- "This part is parallel" let's optimize !
- It's better to fight for a small x2 than for a big x5 !

What to optimize

Two independent parts **A** **B**

Original process



Make **B** 5x faster



Make **A** 2x faster



Introduction : Niklaus Wirth (15 February 1934, 1 January 2024)

Niklaus Wirth in 2005. Niklaus Wirth



Wirth Projects

- Pascal 1968-1972 Pascal2 / P-Code - UCSD - TurboPascal
- Modula2 1973-76
- Oberon 1977-1980
- Lilith 1977-1981

Books / Articles

- "The Pascal User Manual and Report"
- Algorithms + Data Structures = Programs
- Wirth's law (1995) **"Software is getting slower more rapidly than hardware is becoming faster."**
Article "A Plea for Lean Software"

Introduction : Low Level Programming Models

Programmer view

How to use an IP block from my program ?

How to activate silicon blocks aka IP

- 1 Independent block
- 2 CPU Write Control Register / active waiting : device handling in OS
- 3 Included into ISA + asm intrinsic
- 4 Include into ISA + IR + code generation

Pro / Cons

- 1 Nothing to do
- 2 Huge Programmer Effort : hidden in OS
- 3 Huge Programmer Effort :
 - cast data in & out
 - manually select instructions
- 4 Compiler global view :
 - Better global optimization opportunities
 - If IP has possible optimizing parameters -> include higher level optimization
 - automatic correct instruction selection

Introduction : CISC-versus-RISC

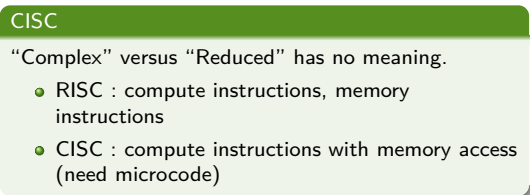
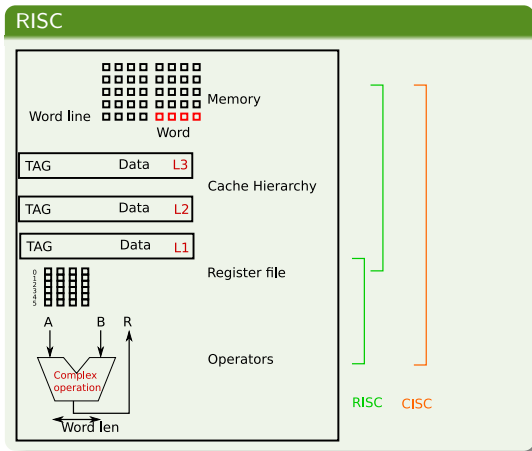

Programming Model : Model-and-Compiler

Compiler life (gcc)

- more than 40 year
- more than 100000 files
- precursor in terms of “eco conception”

Compiler Contains

- SSA form : program as transformable data.
Program transformation : parallelization, vectorization ...
- Register allocation.
- Instruction scheduling : based on data type arithmetics
- Assumptions about target
- Pattern matching for low level instructions selection

Illustration

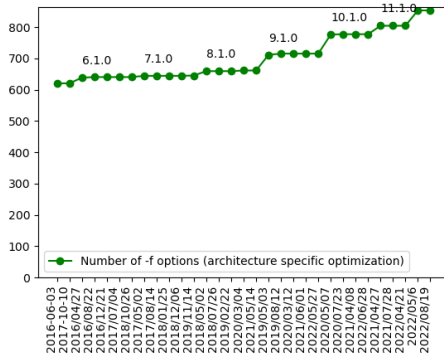

Compiler Support : Compiler And Architecture Links

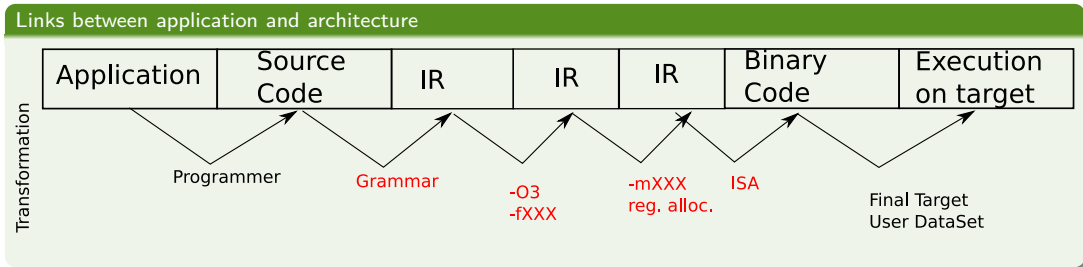

Compiler Support : Compiler And Architecture Links

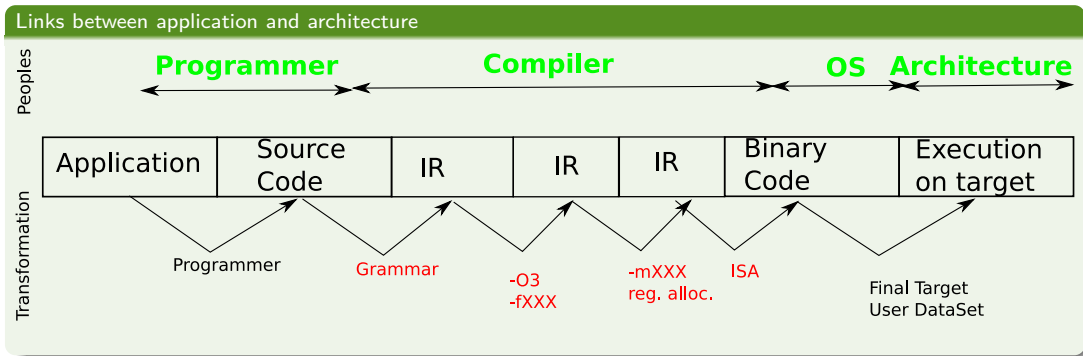

Compiler Support : Compiler And Architecture Links

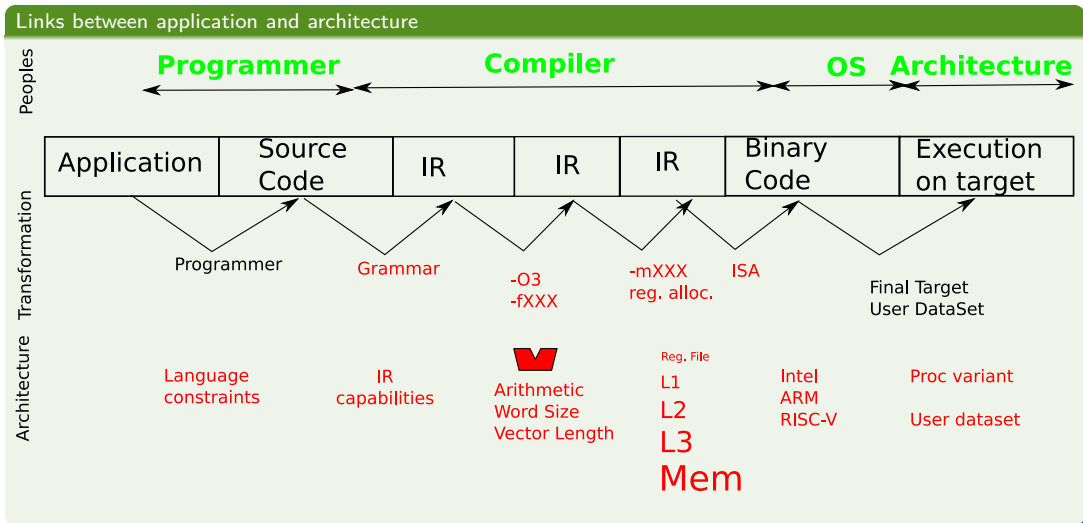

Compiler Support : Compiler And Architecture Links

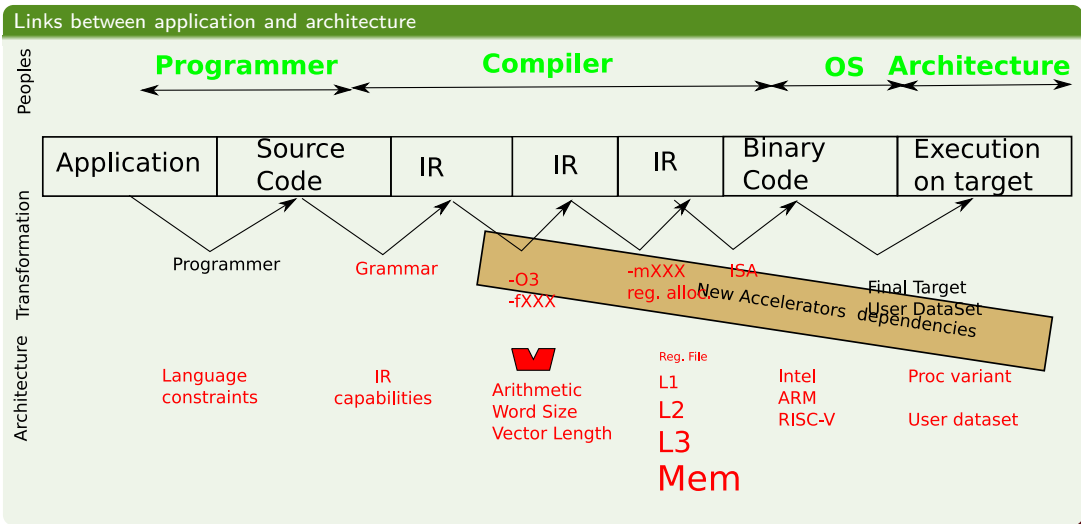

Compiler Support : Compiler And Architecture Links

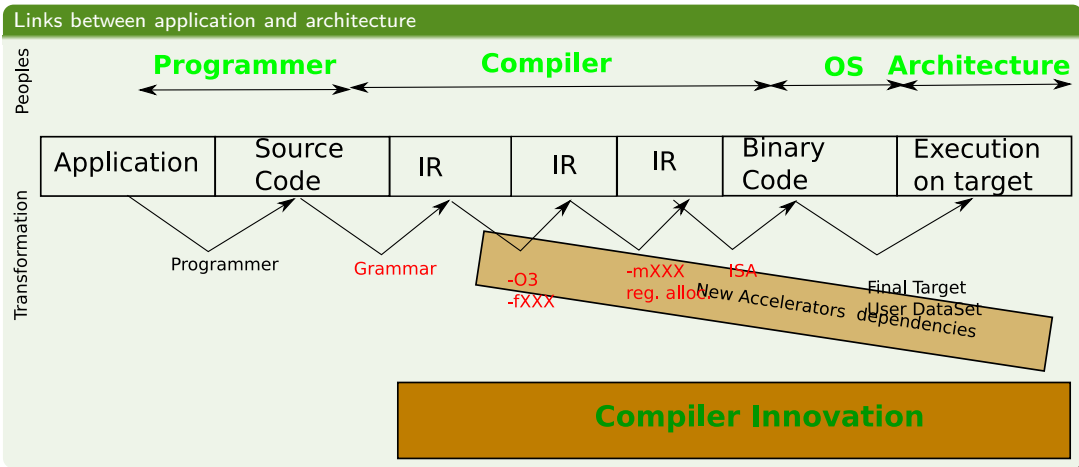

Complete principle : "Working Example"

Control flow in application

Input data sets



Dataset characteristics
control kernel codes

Control flow

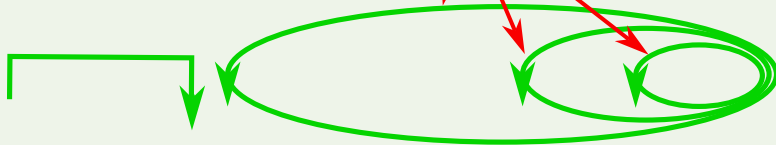

Binary code
memory map

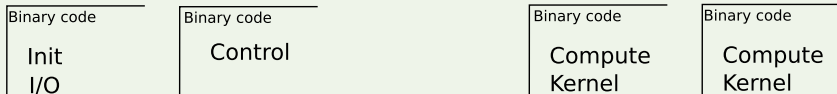

Comiplette principle : "Working Example"

Control flow in application with dynamic adaptation

Input data sets



Dataset characteristics
control kernel codes

Control flow



Binary code
memory map

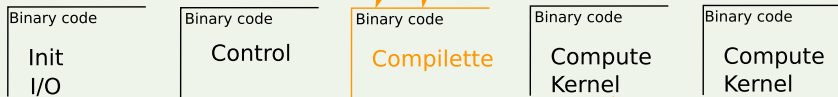

Dataset characteristics
control code specialization

List of Code Generation Scenarios

Compilation scenarios

- (a) Static compilation
- (b) Dynamic adaptation
 - ① Program initialization
 - ② Kernel initialization
 - ③ Application controlled
 - ④ Heterogeneous architecture (multi-isa support)

Target list

- RISC-V (Embedded system)
- CSRAM (Embedded system)
- POWER 8 (HPC computer)
- AARCH64 (both)
- Others (both)

All following scenarios examples works on all platforms

Illustration

Code generation

Code execution

Compilation

(a) Static
gcc/clang

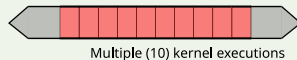

(b) Dynamic
HybroGen

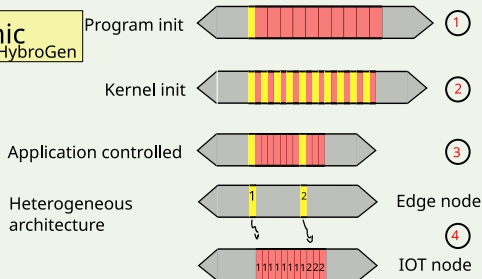

Compiler Support : HybroLang DSL description

Specific features

- C like syntax
- Variable are hardware registers
- Mix run time data values and binary code
 - `#(C expression) include C expression`
- Datype triplet
arithmetic wordlen vectorlen
 - `int 32 1 scalar int`
 - `flt 32 2 vector of 2 floats`
 - `flt 32 #(vlen) vlen vector of floats`
 - `flt #(wlen) 4 vector of 2 floats of size wlen`

"Multi-time" Code Generation

- Static time : Generate binary code generator
 - Included into compilation chain, replace a part of the C code
- Run-time : Generate binary code
 - Faster than any JIT
 - Small code generator able to fit on embedded platforms

HydroGen : Simple-Add-Source

Simple Addition with specialization

```
typedef int (*pifi)(int);

h2_insn_t * genAdd(h2_insn_t * ptr, int b)
{
    #[
    int 32 1 add (int 32 1 a)
    {
        int 32 1 r;
        r = #(b) + a; // b values will be included in code generation
        return r;
    }
    ]#
    return (h2_insn_t *) ptr;
}
```

Examples : CSRAM (Computational SRAM)

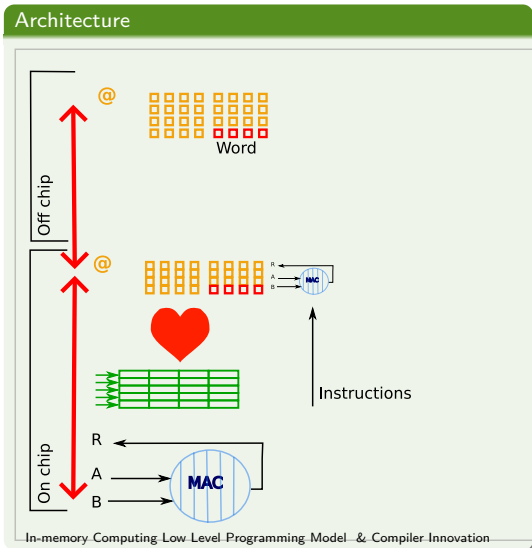

Programmer view

- Single program flow
- Non Von Neumann model : CPU send instructions to CSRAM
- DSL approach, which express
 - Heterogeneous computation (DONE)
 - Memory hierarchy (ONGOING)

Software support

- HygroLang compiler
<https://github.com/CEA-LIST/HydroGen>
- Fonctionnal emulator (based on QEMU): <https://github.com/CEA-LIST/csram-qemu-plugin>

Inverted Von Neumann Programming Model

Chosen Programming model

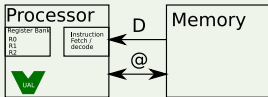

Bus transactions

Code

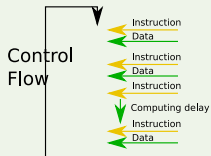

```
ld r0 = @A
ld r1 = @B
add r2 = r0, r1
st r2 = @C
```



Bus transactions

Code

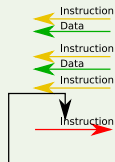

```
ld r0 = @ISrc1
ld r1 = @ISrc2
ld r2 = @IDst
add IDst = ISrc1, ISrc2
increment line addresses
```

Why ?

- Allows scalability :
 - Any vector size
 - Any tile number
 - Any system configuration : near or far IMC
- Works with any processor

Programming Model : Image Diff

Mini code Example : HybroLang code example

```
pifiii genSubImages(h2_insn_t * ptr){  
#[  
  int 32 1 subImage(int[] 16 8 a, int[] 16 8 b, int[] 16 8 res, int 32 1 len)  
  {  
    int 32 1 i; // int 32 1 = RISC-V register  
    // int[] 16 8 = array of C-SRAM lines  
    for (i = 0; i < len; i = i + 1) // Control done on RISC-V  
      {  
        res[i] = a[i] - b[i]; // Workload done on C-SRAM  
      }  
  }  
  return 0;  
]#  
  return (pifiii) ptr;}
```

Compiler support

- Dynamic interleaving
- Instruction generator generator notion



HybroGen : ImageDiff-Run

CxRAM Usage

- Compute image difference
- Iterate on image lines (RISCV)
- Use difference operators / 16 pixels wide (CxRAM)

Dataset

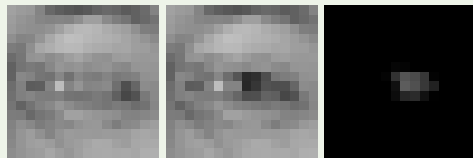

CxRAM-Status : Circuit

Chip design evolution

- 1 chip built, characterized : CSRAM part only, (photo)
- Result published : “A 35.6TOPS/W/mm² 3-Stage Pipelined Computational SRAM with Adjustable Form Factor for Highly Data-Centric Applications” 2020
- 1 chip built, under testing / characterization : CSRAM + RISC-V
- Ongoing work on new instruction set variants

IMPACT circuit (2019)

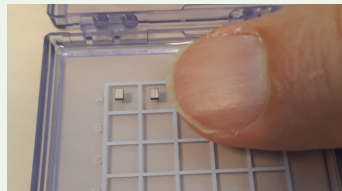

RISC-V and CSRAM under testing (2023)

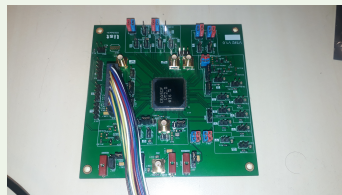

Conclusion : Conclusion

Architecture point of view

- Application ? Future is not only based on deep learning !
- Parallelism type
- **Memory layout is a key !**
 - DRAM interleacing
 - Data locality / alignment

Tools for collaborations

- DSL / Compiler :
<https://github.com/CEA-LIST/HydroGen>
- Emulator, based on QEMU : <https://github.com/CEA-LIST/csram-qemu-plugin>

HydroGen Roadmap

- Include data value based run-time optimization (Already started)
- Include explicit data movement for sparse accelerators
- Include variable precision floating point number
- Include system level PIM capabilities
- more to come on the road