



**HAL**  
open science

## **Nanopix v1: a compact miniaturized coded aperture gamma imager**

Guillaume Amoyal, Vincent Schoepff, Frédérick Carrel, Lionel Tondut, Christopher Helbert, Michael Fiederle, Alexander Fauler, Johann Plagnard, Roger Abou-Khalil, Zakkarya Mekhalfa, et al.

► **To cite this version:**

Guillaume Amoyal, Vincent Schoepff, Frédérick Carrel, Lionel Tondut, Christopher Helbert, et al.. Nanopix v1: a compact miniaturized coded aperture gamma imager. Nuclear Instruments and Methods in Physics Research Section A: Accelerators, Spectrometers, Detectors and Associated Equipment, 2024, 1068, pp.169718. 10.1016/j.nima.2024.169718 . cea-04691658

**HAL Id: cea-04691658**

**<https://cea.hal.science/cea-04691658v1>**

Submitted on 9 Sep 2024

**HAL** is a multi-disciplinary open access archive for the deposit and dissemination of scientific research documents, whether they are published or not. The documents may come from teaching and research institutions in France or abroad, or from public or private research centers.

L'archive ouverte pluridisciplinaire **HAL**, est destinée au dépôt et à la diffusion de documents scientifiques de niveau recherche, publiés ou non, émanant des établissements d'enseignement et de recherche français ou étrangers, des laboratoires publics ou privés.

# Nanopix-v1: a compact miniaturized coded-aperture gamma imager.

1  
2 G. Amoyal<sup>(a)</sup>, V. Schoepff<sup>(a)</sup>, F. Carrel<sup>(a)</sup>, L. Tondut<sup>(b)</sup>, C. Helbert<sup>(c)</sup>, M. Fiederle<sup>(d)</sup>, A. Fauler<sup>(d)</sup>, J. Plagnard<sup>(e)</sup>, R.  
3 Abou-Khalil<sup>(f)</sup>, Z. Mekhalfa<sup>(f)</sup>, M. Imbault<sup>(a)</sup>, Q. Adeline<sup>(a)</sup>.

4 <sup>(a)</sup> *Université Paris-Saclay, CEA, List, F-91120 Palaiseau, France.*

5 <sup>(b)</sup> *Orano Business Unit Recycling, DT/E/MN/EXP, F-50440 La Hague, France.*

6 <sup>(c)</sup> *Orano DS – DTI/ICM, F-50440 La Hague, France.*

7 <sup>(d)</sup> *Freiburger Materialforschungszentrum, Albert-Ludwigs-Universität Freiburg, D-79104 Freiburg, Germany.*

8 <sup>(e)</sup> *Université Paris-Saclay, CEA, List, Laboratoire National Henri Becquerel (LNE-LNHB), F-91120 Palaiseau, France.*

9 <sup>(f)</sup> *Orano Group, 125 Avenue de Paris, Châtillon 92320 France.*

## 10 ABSTRACT

11 This article explores the complex challenges associated with detecting and identifying radioactive hotspots in the nuclear industry  
12 using gamma cameras. Gamma cameras facilitate the localization of radioactive hotspots by overlaying a visualization of  
13 radioactivity onto a visible image. In the nuclear industry, gamma rays are observed in an energy range spanning from 59.5 keV  
14 (Am-241) to 1.3 MeV (Co-60).

15 The motivation for this exploration stems from a specific challenge: characterizing hot-cells inaccessible to human operators. At  
16 the ORANO La Hague radioactive waste reprocessing plant, access to these restricted regions is possible through apertures with  
17 diameters ranging from 8 to 10 cm. In collaboration, the Nanopix-v1, characterized by its compact form as a coded mask gamma  
18 imaging system, with dimensions of  $8 \times 5.1 \times 4.3$  cm<sup>3</sup> and a mass of 268 g, was developed through the synergistic efforts of CEA  
19 List and X-ray Imaging Europe (XIE) in partnership with ORANO.

20 This article conducts a detailed examination of the laboratory and in situ performance of the Nanopix-v1, carried out within the  
21 challenging operational environment of the La Hague radioactive waste reprocessing plant. The focal point of the article is a  
22 comprehensive exploration of the technological components supporting the Nanopix-v1, along with an explanation of the coded  
23 mask imaging localization methodologies that underpinned the rigorous evaluation process. The performance of the gamma camera  
24 is evaluated through a series of carefully conducted trials, aimed at evaluating the angular resolution and minimum measurement  
25 time, including laboratory conditions, experimentation within a metrological Cs-137 irradiator, and practical implementation at the  
26 ORANO La Hague site.

## 28 I. INTRODUCTION

29 The detection and precise identification of radioactive hotspots present a formidable challenge across various domains within the  
30 nuclear industry, encompassing radiation protection measurements within nuclear power plants, decommissioning operations,  
31 responses to post-accidental events like the Fukushima incident, and applications vital for Homeland Security. Addressing this  
32 challenge necessitates the utilization of transportable and readily deployable systems. One efficacious solution lies in the  
33 deployment of gamma cameras, capable of superimposing gamma ray images onto visible images to pinpoint radioactive hotspots  
34 within their field of view.

35 Within the context of applications at the La Hague radioactive waste reprocessing site, the prominent French entity ORANO  
36 articulated the imperative to access zones with heightened radioactivity, ascertain the presence of radioactive hotspots, and respond  
37 promptly. Access to these zones is exclusively attainable via chute holes characterized by diameters ranging from 8 to 10 cm,  
38 thereby requiring a compact gamma camera with at least two of its geometric dimensions measuring below 8 cm.

39 In recent years, several research teams have dedicated their efforts to the development of Compton or coded aperture gamma-ray  
40 imagers tailored explicitly for use in the nuclear industry. CEA List, for instance, embarked on the development of a coded aperture  
41 gamma camera named GAMPIX in the late 2000s [1–3]. Subsequently, MIRION Technologies undertook the industrialization of  
42 this CEA List prototype, and it is now available in the commercial market under the name iPIX [4]. The iPIX camera measures  
43  $9.0 \times 9.0 \times 18.8$  cm<sup>3</sup> in terms of its dimensions. Notably, other gamma imaging systems designed for nuclear industry applications  
44 have emerged, including the ASTROCAM 7000HS by Mitsubishi Heavy Industries, ( $44.5 \times 34.0 \times 23.5$  cm<sup>3</sup>), NuVISION [5] by  
45 NUVIA ( $12.0 \times 24.0 \times 18.0$  cm<sup>3</sup>), POLARIS H [6] by H3D ( $24.0 \times 8.6 \times 18.0$  cm<sup>3</sup>), Spid-X by 3D Plus Detection Systems  
46 ( $18.0 \times 11.0 \times 32.3$  cm<sup>3</sup>), and Temporal Delta by DAMAVAN ( $21.0 \times 29.0 \times 16.0$  cm<sup>3</sup>), to name a few.

47 It is noteworthy that the geometric dimensions of the existing industrial gamma imaging systems mentioned above render them  
48 unsuitable for access to the areas of interest within the La Hague facility. In close collaboration with ORANO, CEA List has  
49 ingeniously developed a compact coded mask gamma imaging system, christened Nanopix-v1, sharing technological components

50 with the GAMPIX gamma camera. Eventually, the Nanopix-v1 system boasts dimensions of  $7.9 \times 5.1 \times 4.3$  cm<sup>3</sup>, a mass of 268 g,  
 51 and a field of view of 44°. Nanopix-v1 is able to locate gamma-rays emitters whose energy range from 59.5 keV (Am-241) up to  
 52 1.3 MeV (Co-60) with an angular resolution around 5°.

53  
 54 This article primarily centers on the comprehensive developments surrounding Nanopix-v1, encompassing an evaluation of its  
 55 performance within laboratory settings and the La Hague site. In paragraph II, we will delve into the foundational building blocks  
 56 of Nanopix-v1, elaborate on the coded mask imaging localization techniques employed alongside Nanopix-v1, and outline the  
 57 methodologies employed for performance assessment. Subsequently, paragraph III will focus on the experimental evaluation of  
 58 the Nanopix-v1 gamma camera's performance, commencing with laboratory conditions and progressing to the evaluation of its  
 59 response within the LNHB (Henri Becquerel National Laboratory) metrologically qualified Cs-137 irradiator, extending to  
 60 assessments conducted at the ORANO La Hague site.

## 61 II. MATERIAL AND METHODS

### 62 A. Nanopix-v1 gamma coded-aperture gamma imager

#### 63 1) Building blocks of Nanopix-v1

64 The foundational element of Nanopix-v1 is the detector board, responsible for providing measurement data. Gamma rays, measured  
 65 in the nuclear industry, span an energy range from 59.5 keV, attributed to Am-241, to 1.3 MeV, associated with Co-60. To tackle  
 66 this challenge, the selected detector is a modified USB Lite readout interface [7], incorporating a Timepix ASIC [8]. Timepix, a  
 67 pixelated counting chip, operates in frame-based mode, comprising  $256 \times 256$  pixels with a 55  $\mu$ m pitch, allowing for the  
 68 measurement of the position and energy deposited by ionizing particles. The sensitive component of the detector block is a 1-mm  
 69 thick high-resistivity p-type cadmium telluride semiconductor, bump-bonded to Timepix. This particular sensor was chosen for its  
 70 intrinsic performances, aligning most effectively with the challenges associated with detecting gamma rays in the nuclear  
 71 industry [9]. The integrated source of detector bias within the USB Lite can provide a 5 to 100 V, which is not enough to bias the  
 72 1-mm thick CdTe semiconductor, that requires a bias of -300 V. Therefore a USB driven external power supply is mounted on the  
 73 USB Lite. A cooling bridge is also mounted on the assembly in order to keep the detector block at room temperature. The detector  
 74 block, composed of the USB Lite module and the Timepix ASIC hybridized with a 1-mm thick CdTe semiconductor, the cooling  
 75 bridge and the external power supply is shown in Figure 1. The USB Lite module embedded in Nanopix-v1 is not energy calibrated,  
 76 however, it has been estimated that its low energy threshold is around 10 keV.

77  
 78 *Table I: Characteristics of USB Lite readout interface [7].*

Serial readout speed	4 Mbit/s (4 fps)
Integrated source of detector bias	5 – 100 V.
Dimensions	15×60 mm <sup>2</sup>
Data transfer	USB

79

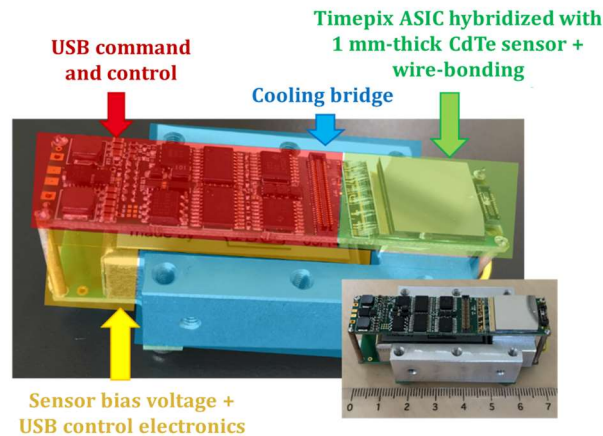

80  
 81 *Figure 1: The detector block of Nanopix-v1, composed of a USB Lite module, an external power supply and a cooling bridge.*

82 The two other building blocks associated with the pixelated detector (i.e., Timepix) to build a gamma imager are the coded aperture  
 83 and the visible camera. The coded aperture consists of a rank 7 MURA coded aperture [10], with a thickness of 4 mm, made of  
 84 tungsten alloy. The choice of the coded aperture is based on previous studies around the GAMPIX gamma camera [2] and results  
 85 from a trade-off between the minimum time of measurement and angular resolution over the energy range of measured gamma-rays  
 86 in the framework of nuclear industrial applications. The dimensions of the coded aperture pattern are such that the fully-coded  
 87 field of view covers the whole sensor [11], and the central part of the coded-aperture basic pattern has the dimensions of the sensor  
 88 [12]. This results in a coded-aperture pattern with dimensions of  $2.8 \times 2.8$  cm<sup>2</sup>, and composed of  $13 \times 13$  individual aperture cell of

89 0.2154 cm pitch. The distance between the sensor and the coded-aperture is 1.4 cm, providing a fully-coded field of view of  $44^\circ$ .  
 90 Eventually, the manufactured coded-aperture with dimensions of  $3.4 \times 3.4 \times 0.4 \text{ cm}^3$  and a total mass of 48 g.

91  
 92 Regarding the visible camera, a research effort on compact visible optics enabled to significantly reduce its dimensions. By  
 93 positioning it as close as possible to the detector interface card (a few millimeters), unused internal spaces can be removed. Thus,  
 94 the size of the gamma camera is mainly determined by the detection block shown in Figure 1. Figure 2 shows the Nanopix-v1  
 95 gamma camera, (a) a footprint drawing is presented, and (b) and (c) show two pictures of Nanopix-v1 from two different  
 96 perspectives. The final dimensions of Nanopix-v1, with all building blocks integrated, are  $7.9 \times 4.3 \times 5.1 \text{ cm}^3$ , for a total mass of  
 97 268 g.  
 98

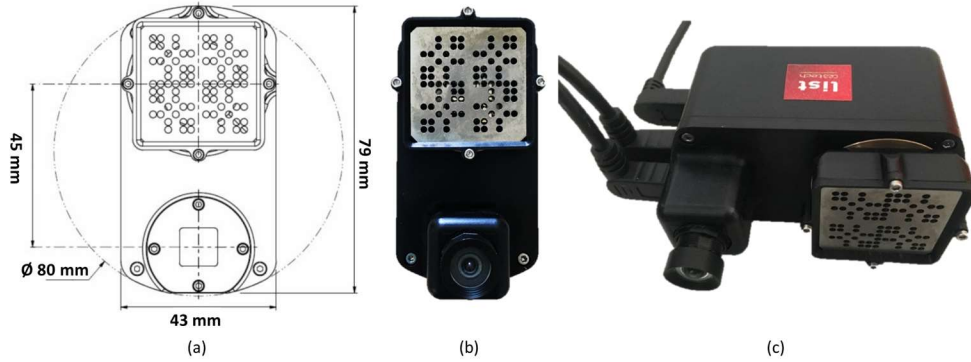

99  
 100 Figure 2: (a) Footprint drawing of Nanopix-v1 gamma camera, (b) and (c) photographs of Nanopix-v1 from two different perspectives.

101  
 102 Table II: Main characteristics of Nanopix-v1.

<b>Sensor</b>	CdTe – $14.08 \times 14.08 \times 1 \text{ mm}^3$
<b>Pixelisation</b>	$256 \times 256$ pixels – $55 \mu\text{m}$ pitch
<b>Coded aperture</b>	MURA rank 7 in tungsten, thickness: 4 mm
<b>Field of view</b>	$44^\circ$
<b>Communication protocol</b>	USB
<b>Dimensions</b>	$7.9 \times 4.3 \times 5.1 \text{ cm}^3$
<b>Weight</b>	268 g
<b>Low energy treshold</b>	$\sim 10 \text{ keV}$

## 102 2) Raw frame analysis

103 When a gamma ray interacts with the CdTe semiconductor, Timepix provides information about the position of the interaction and  
 104 the energy deposited within the sensor, in the form of a frame composed of  $256 \times 256$  pixels. In Timepix, the energy of the  
 105 interaction is measured using a Time-over-Threshold (ToT) method [13]. The ToT value for each interaction is measured by a  
 106 clock, whose frequency is set at 40 MHz. This results in a ToT value of 25 ns, which represents the amount of time that the signal  
 107 from the interaction is above a given threshold. The ToT value is proportional to the energy deposited in the detector by the  
 108 interaction, and can be used to determine the energy spectrum of the incident radiation.

109 The Nanopix-v1 yields measured data in the form of a  $256 \times 256$  ToT value matrix. When a particle interacts with the CdTe  
 110 semiconductor, it may illuminate several adjacent pixels, resulting in a cluster of pixels. To determine the energy deposited by the  
 111 particle, it is necessary to identify each pixel cluster, which is achieved through the utilization of the DBSCAN algorithm [14].  
 112 Figure 3 demonstrates the application of the DBSCAN algorithm to identify pixel clusters within a measured frame. The frames  
 113 displayed in Figure 3 ( $76 \times 66$  pixels) are a subset of an entire measured frames ( $256 \times 256$  pixels).  
 114  
 115

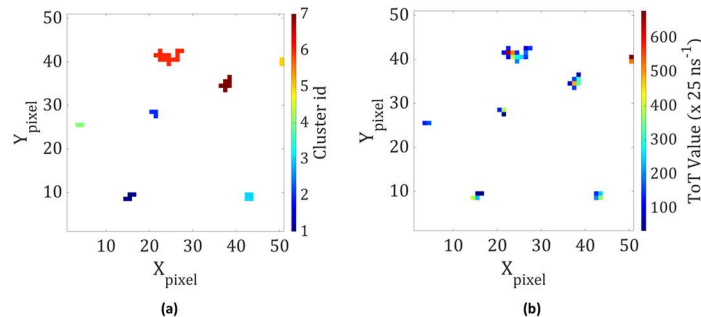

116  
 117 Figure 3: Representation of cluster identification using DBSCAN algorithm, on the left-hand side, a measured frame with ToT values assigned  
 118 to each pixels; on the right-hand side, pixels that belong to the same cluster are identified by assigning the same color.

119  
120  
121  
122  
123  
124  
125  
126  
127  
128  
129  
130

After identifying the different clusters of pixels in a given frame, the ToT spectrum is reconstructed by summing the ToT values of each cluster. Examples of measured ToT spectra using Am-241, Cs-137, and Co-60 sources are shown respectively in Figure 4 (a), (b) and (c). In the Am-241 ToT spectrum, two peaks are clearly distinguishable: the peak with the highest ToT values (in red) corresponds to the full absorption peak at 59.5 keV, while the peak with the lowest ToT values (in blue) corresponds to a mixture of X-ray fluorescence lines of cadmium and telluride (K shell lines), along with their associated escape peaks. The Cs-137 ToT spectrum highlights the full absorption peak at 661.7 keV in red. However, in the Co-60 ToT spectrum, the full absorption peaks at 1.173 MeV and 1.332 MeV are not reconstructed, and only the Compton edges can be identified. For Co-60 gamma-rays, Compton scattering is the main interaction occurring within the semiconductor, and once scattered, photons may be absorbed. Since the positions of the Compton scattering and the absorption are different, the pixel clusters resulting from these interactions cannot be geometrically joined and identified as a single interaction, resulting in the total absorption peak being unreconstructed.

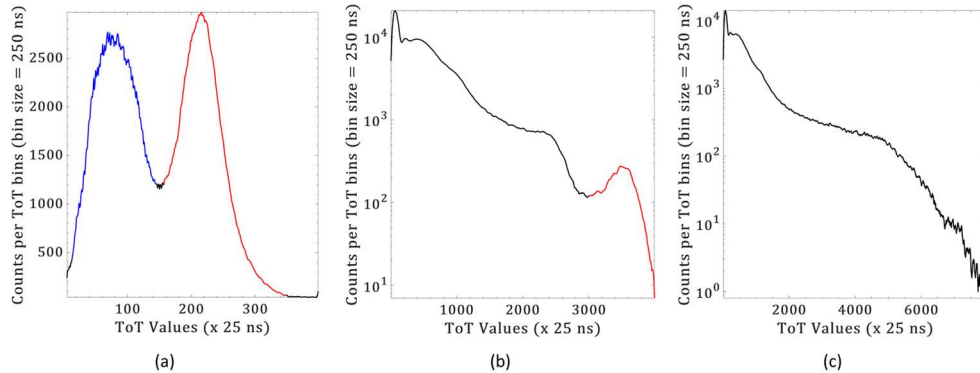

131  
132

Figure 4: Examples of ToT spectra measured with Nanopix using Am-241 (a); Cs-137 (b); Co-60 (c) sources.

133  
134  
135  
136  
137  
138  
139  
140  
141  
142  
143  
144  
145  
146  
147  
148  
149  
150  
151  
152  
153  
154  
155  
156  
157  
158  
159  
160  
161  
162

### 3) Coded-aperture imaging with Nanopix-v1

Gamma cameras using coded-aperture employ a spatial modulation imaging technique where a coded-aperture made up of a specific pattern of opaque and transparent elements is positioned between the sensitive detection area and the radioactive source. This results in the photons emitted by the source projecting a shadowgram of the coded-aperture pattern on the detection area. The Nanopix-v1 gamma camera uses a MURA coded-aperture and the decoding algorithm proposed in [10], based on a convolution product between the shadowgram and the matrix describing the coded-aperture pattern. This algorithm involves convolving the shadowgram with a decoding function represented by the coded-aperture pattern. To eliminate gamma background caused by radioactive sources outside the gamma camera's field of view and also compensate the coded-aperture transparency when the energies of gamma-rays increases, we employ the "mask/anti-mask" procedure (MAM), which involves taking a second measurement after rotating the mask by 90° [10]. Therefore, for a given measurement, two shadowgrams are measured: one for the "mask" measurement, and a second one for the "anti-mask" measurement. Then, the "anti-mask" shadowgram is subtracted to the "mask" shadowgram. In its current stage, the "mask/anti-mask" procedure is not automated, and the mask should be rotated or by means of an external system.

A ToT discrimination may also be applied on the interaction of interest used to build the shadowgram, enabling spectral imaging. This feature can be of interest if multiple radionuclides are simultaneously present in the scene to be imaged.

From this shadowgram and by using knowledge of the coded-aperture pattern, the radioactive source can be reconstructed in a decoded image [10,11]. The decoded image is obtained by performing a convolution operation between the shadowgram, which is a matrix of  $256 \times 256$  cumulated ToT values per pixel, and the Point Spread Function (PSF), described by the mask pattern. The result of this convolution is a new matrix of  $256 \times 256$  ToT values that represents the decoded image. The hotspot, which corresponds to the position with the highest intensity in the decoded image, represents the location of the radioactive source.

Once the decoded image is reconstructed, a threshold may be applied to highlight the hotspot with respect to the background. The common threshold value with Nanopix-v1 is 50 % of the maximum value in the decoded image. This threshold value is chosen by default in our application for the reasons mentioned hereafter. Firstly, this serves to "eliminate" statistical noise in the reconstructed image. Secondly, it corresponds to the value of the Rayleigh criterion, where two peaks are considered separable. Using a threshold value of 50 % thus indirectly applies this criterion to the decoded image. However, the threshold value may be adjusted, notably, if several sources or extended sources are present in the reconstructed area.

Examples of a shadowgram and the associated normalised decoded image, with and without threshold, of a radioactive source located in the center of the Nanopix-v1 field-of-view are shown in Figure 5.

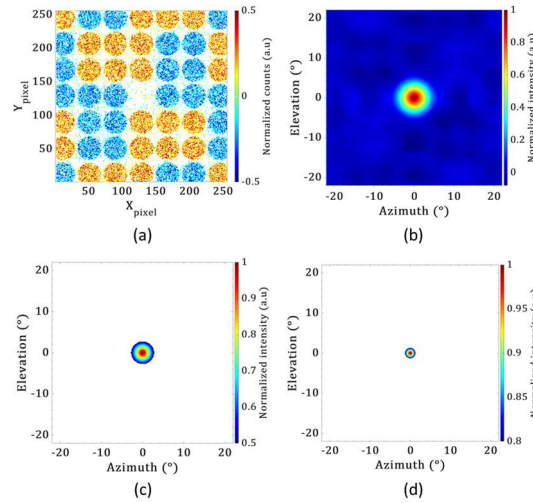

Figure 5: Examples of a shadowgram from a MAM procedure (a); (b) the associated decoded image without threshold; (c) the associated decoded image with a 50 % threshold; (d) the associated decoded image with an 80 % threshold. The radioactive source is located in the center of the field-of-view of the Nanopix-v1 gamma imager.

### B. Angular resolution

In coded aperture gamma imaging, the angular resolution, expressed in degrees, defines the capability of a system to separate two elements in the decoded image. From a given geometry, composed of a planar detector and a planar MURA coded aperture, the theoretical angular resolution can be calculated from equation (II-1) [12]. In equation (II-1),  $\theta_{geom}$  is the theoretical angular resolution,  $b$  is the dimension of an individual coded aperture cell, and  $z$  the aperture-to-detector distance. For Nanopix-v1, the dimensions of an individual aperture cell  $b$  is 0.2154 cm, and the aperture-to-detector distance  $z$  is 1.4 cm, providing a theoretical angular resolution of  $4.41^\circ$ . It has to be mentioned that this value only takes into account geometrical properties of the system, and does not take into account the aliasing of the coded-aperture and its transparency, that respectively depend on the source location and energy of the gamma-rays.

$$\theta_{geom} = \frac{b}{2*z} \text{ (rad)} \quad (\text{II-1})$$

In this study, the angular resolution is evaluated experimentally. It is calculated from the horizontal hot spot profile (HHSP), and the vertical hot spot profile (VHSP) by means of a gaussian fitting on the profiles. Both profiles are extracted from the maximum of the decoded image. The angular resolution corresponds to the full width at half maximum (FWHM) of the fitted gaussian. To assess the uncertainty associated with the calculated FWHM, and so the uncertainty associated with the angular resolution, we perform bootstrap sampling [15]. The number of fit trials per bootstrap sample to estimate the uncertainty of the gaussian fit is set arbitrarily to 500. The values in the decoded image are initially expressed in pixels and to convert these values in degrees, we use equation (II-2), in which  $A$  is the value in degree,  $B$  is a value in pixel,  $FoV$  corresponds to the fully coded field of view (i.e.,  $44^\circ$ ),  $N$  is the number of horizontal or vertical pixels (i.e., 256).

$$A = \frac{B*FoV}{N} \text{ (}^\circ\text{)} \quad (\text{II-2})$$

### C. Minimum measurement time

Minimum measurement time is defined as the minimum time required to locate a radioactive hotspot within the decoded image. It has to be mentioned, that for this study, the minimum measurement time is evaluated when the radioactive source is located in the center of the field of view.

This approach involves comparing the decoded image for a given measurement time ( $t_m$ ) to a decoded image obtained for a measurement time where the hot point is correctly localized. If the two images correspond, then the time  $t_m$  is considered sufficient to locate the hot point. To evaluate the accuracy of hot point localization at time  $t_m$ , the operation is repeated  $N$  times using random frames, allowing the percentage of cases where the hot point is correctly reconstructed for the given  $t_m$  to be evaluated.

First, a measurement is carried out with a sufficient number of frames using the MAM procedure. For this study, the minimum measurement time is evaluated using laboratory radioactive sources, described in paragraph III.A, for which a set of 7200 frames of 1 s in “mask”, and 7200 frames of 1 s in “anti-mask” are measured, for a total of 14400 frames. This decoded image corresponds to the “reference” decoded image (RDI). The next step consists in comparing decoded image obtained for a given time of

202 measurement (DIGTM) to RDI. The comparison is carried out by means of two criteria. The initial metric we consider is the 2-D  
 203 correlation coefficient  $R$  between DIGTM and RDI, which is defined by the Pearson's correlation described by equation (II-3). In  
 204 this equation,  $X_{ij}$  represents the intensity of the  $(i,j)$ th pixel in image  $X$ ,  $Y_{ij}$  represents the intensity of the  $(i,j)$ th pixel in image  $Y$ ,  
 205 and  $\bar{X}$  and  $\bar{Y}$  correspond to the average intensities of images  $X$  and  $Y$ , respectively. The 2-D correlation coefficient is a measure of  
 206 the similarity between two images, which quantifies their correlation. It takes values between -1 and 1, where -1 indicates perfect  
 207 inverse correlation, 0 indicates no correlation, and 1 indicates perfect direct correlation. The closer the value is to 1, the more  
 208 similar the two images are, and vice versa for values close to 0. Negative values indicate inverse correlation between the images.  
 209 For the study of the minimum measurement time, we chose a value of 0.5 to evaluate the similarity of the RDI and a DIGTM. At  
 210 this stage of development, the value of the correlation criterion is chosen empirically. An additional study must be conducted to  
 211 assess the impact of this value on the evaluation of the minimum measurement time.  
 212

$$R = \frac{\sum_i \sum_j (X_{ij} - \bar{X})(Y_{ij} - \bar{Y})}{\sqrt{(\sum_i \sum_j (X_{ij} - \bar{X})^2)(\sum_i \sum_j (Y_{ij} - \bar{Y})^2)}} \quad (\text{dimensionless}) \quad (\text{II-3})$$

213  
 214 A second criterion is used in addition to the 2-D correlation coefficient, which is based on the number of hot spots reconstructed  
 215 in the DIGTM. The DIGTM is considered correct only if a single hot spot is reconstructed, as there is by definition only one  
 216 radioactive source positioned in the system's field of view. Examples of a RDI, and of a DIGTM fulfilling evaluation criterion, a  
 217 DIGTM fulfilling the 2-D correlation criterion but not the criterion regarding the number of hotspots, and a DIGTM that does not  
 218 meet both criteria are shown in Figure 6.  
 219

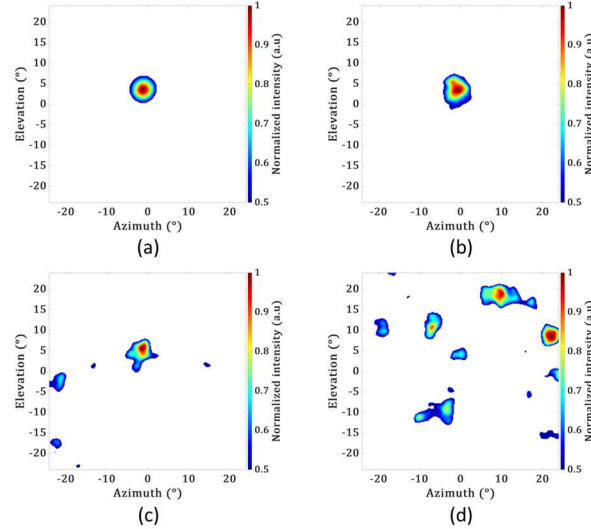

220  
 221 *Figure 6: Examples of a reference decoded image with a threshold at 50 % (RDI) (a); a decoded image for a measurement time (DIGTM)*  
 222 *fulfilling both criteria to validate the correct localization of the hot spot (b); a DIGTM fulfilling the 2-D correlation criterion but not the*  
 223 *criterion regarding the number of reconstructed hot spots (c); and a DIGTM that does not meet the evaluation criteria (d).*

224 In order to evaluate the reproductibility to correctly localizing a hot spot within a given time of measurement  $t_m$ , the operation is  
 225 repeated 1000 times. The selection of frames for each repetitions is carried out by means of a random combination between the  
 226 entire set of 7000 mask frames, and 7000 anti-mask frames. As an example, for a given measurement time  $t_m$  of 10 seconds,  
 227 5 mask frames and 5 anti-mask frames are randomly selected. Then, the percentage of DIGTM matching both evaluation criteria  
 228 is calculated, providing a confidence percentage regarding the capability of the system to correctly reconstruct a hotspot in a given  
 229 measurement time.

### 230 III. EXPERIMENTAL RESULTS

#### 231 A. Laboratory measurement

##### 232 1) Radionuclides

233 To experimentally characterize the Nanopix-v1 prototype in terms of minimum measurement time and angular resolution (as  
 234 described in paragraphs II.B and II.C), the first step consisted in evaluating its performance on a large range of laboratory  
 235 radioactive sources. The measurements were made using Am-241, Ba-133, Eu-152, Cs-137, and Co-60 radioactive sources, which  
 236 are presented in Table IV along with their activities and equivalent dose rate  $H^*(10)$  at one meter. These sources were selected  
 237 because they cover a gamma energy range from 59.5 keV (Am-241) to 1.33 MeV (Co-60) and are commonly encountered in the  
 238 nuclear industry. The Am-241, Ba-133, Cs-137 and Co-60 are encapsulated in stainless steel, whereas the Eu-152 source is

239 encapsulated in plastic. For this measurement campaign, the background noise corresponds to natural radioactivity and is less than  
 240 100 nSv.h<sup>-1</sup>.

241  
 242 2) *Angular resolutions*

243 In this study, the horizontal and vertical angular resolutions of Nanopix-v1 were evaluated on the radionuclides described in Table  
 244 III and by means of the method described in paragraph II.B. Table III present results regarding the horizontal and vertical angular  
 245 resolutions obtained with Nanopix-v1. Results show that the horizontal and vertical angular resolutions are lower than 5.3°, and is  
 246 slightly dependent on the energy of the incident gamma rays.

247  
 248 *Table III: Horizontal and vertical angular resolutions evaluation for different radionuclides at a distance of one meter in the center of the field  
 249 of view of Nanopix-v1.*

Radionuclide	Angular resolution (°)	
	Horizontal	Vertical
Am-241	4.76 +/- 0.06	4.64 +/- 0.05
Eu-152	4.82 +/- 0.05	4.96 +/- 0.07
Ba-133	5.20 +/- 0.03	5.28 +/- 0.02
Cs-137	5.19 +/- 0.02	5.12 +/- 0.04
Co-60	4.77 +/- 0.08	4.85 +/- 0.06

250  
 251 3) *Minimum measurement time*

252 The method used in this study to evaluate the minimum measurement time of Nanopix-v1 relies on an evaluation of correctly  
 253 reconstructed decoded image on a range of measurement time as described in paragraph II.C. The evaluation of the minimum  
 254 measurement time of Nanopix-v1 was evaluated on the set of radionuclides described in Table IV.

255 The measurement protocol for each radionuclide is the following: the measurement is performed in “mask/anti-mask”  
 256 (paragraph II.A.3)) with a frame duration of 1 second without ToT discrimination, the considered radionuclide is positioned in  
 257 the center of the field of view of the coded-aperture at a distance of 1 m. Figure 7 shows the percentage of correctly reconstructed  
 258 images versus measurement time for the aforementioned radionuclides.

259 Considering a 90 % confidence level on the reconstructed image, experimental results demonstrate that Am-241 positioned 1 m  
 260 away from Nanopix-v1 (0.35 μSv.h<sup>-1</sup>) can be located in less than 2 s. In contrast, locating Eu-152 with an activity of 6.2 MBq at  
 261 the same distance (1 m) from Nanopix-v1 (1.21 μSv.h<sup>-1</sup>) requires 12 s. Similarly, Ba-133, Cs-137, and Co-60, each with activities  
 262 of 17.5 MBq (1.22 μSv.h<sup>-1</sup>), 34.3 MBq (3.30 μSv.h<sup>-1</sup>), and 10.4 MBq (4.94 μSv.h<sup>-1</sup>), respectively, can be located in 18 s, 54 s, and  
 263 130 s when positioned 1 m away from Nanopix-v1. From those values, the minimum measurement time at a 90 % confidence level  
 264 per equivalent dose rate H\*(10) unit for each radionuclide is calculated. This calculation provides the minimum measurement time  
 265 to correctly localize a radionuclide in the center of the field of view with an equivalent dose rate at Nanopix-v1 of 1 μSv.h<sup>-1</sup>. Those  
 266 values are summarized in Table IV.

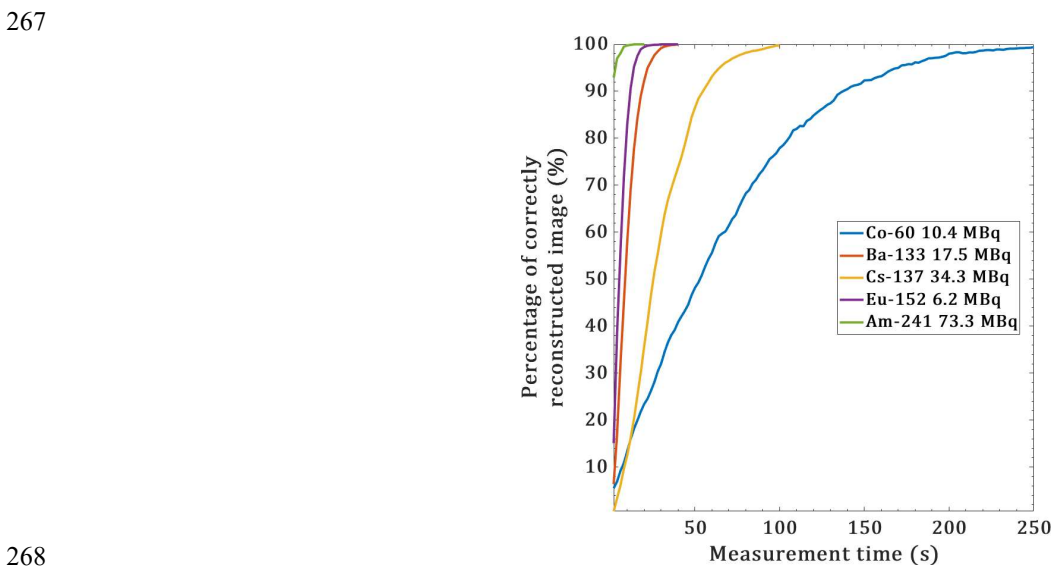

268  
 269 *Figure 7: Percentage of correctly reconstructed images versus measurement time obtained with Nanopix-v1 for Co-60 (blue), Ba-133 (orange),  
 270 Cs-137 (yellow), Eu-152 (purple) and Am-241 (green). Activities and equivalent dose rates H\*(10) at the Nanopix-v1 for each radionuclides  
 271 are described in Table IV. For each measurement, the considered radionuclide is positioned at 1 m of Nanopix-v1 in the center of the field of  
 272 view of the coded-aperture.*

273



Table IV: Minimum measurement time of Nanopix-v1 for different radionuclides with a confidence level at 90 %.

Radionuclide (activity in (MBq))	Equivalent dose rate $H^*(10)^1$ at 1 m ( $\mu\text{Sv}\cdot\text{h}^{-1}$ )	Minimum measurement time at a 90 % confidence level (s)	Minimum measurement time at a 90 % confidence level (s) per equivalent dose rate $H^*(10)$ unit ( $\text{s}\cdot(\mu\text{Sv}\cdot\text{h}^{-1})^{-1}$ )
Am-241 (73.3)	0.35	< 2	< 0.7
Eu-152 (6.2)	1.21	12	14
Ba-133 (17.5)	1.22	18	22
Cs-137 (34.3)	3.30	54	178
Co-60 (10.4)	4.94	130	642

<sup>1</sup>: Measured with a 6150 AD5/H radiameter from Saphymo©.

276

### 277 B. LNHB Cs-137 irradiator

278 A measurement campaign was carried out in a metrologically qualified Cs-137 irradiator to assess the response of Nanopix-v1 in  
 279 terms of integrated dose. The Cs-137 irradiator is located at the LNHB, CEA List institute, Paris-Saclay site and is well known as  
 280 one of the foremost national standards in the area of ionizing radiation. It is an essential component of the Laboratoire National de  
 281 Métrologie et d'Essais (LNE), and it operates under the reference COFRAC accreditation. This accreditation delineates the range  
 282 of validity of the primary references concerning dose rate.

283 The measurement campaign consisted in a set of 12 different measurements, whose objectives were to evaluate the behavior of  
 284 Nanopix-v1 on a set of different dose rates. For each measurement, the integrated dose at Nanopix-v1 is known with a relative  
 285 uncertainty of 5.7 % ( $k=2$ ). The background noise is natural radioactivity (less than 100 nSv.h<sup>-1</sup>). For a given measurement, the  
 286 intensity (in ToT values as mentioned in paragraph II.A.3)) in the reconstructed hotspot is calculated by integrating the latter. To  
 287 estimate the uncertainties on the numbers of hits in the hotspots, each measurement at a given dose rate is divided in  
 288 sub-acquisitions whose measurement time is three times minimum measurement time of Nanopix-v1 to reconstruct an image at a  
 289 90 % confidence level for a given radionuclide (paragraph A.3)). To locate a Cs-137 with an equivalent dose rate  $H^*(10)$  of  
 290 3.30  $\mu\text{Sv}\cdot\text{h}^{-1}$  with a 90 % confidence level, Nanopix-v1 requires 54 s. Therefore, to locate a Cs-137 with an equivalent dose rate  
 291  $H^*(10)$  of 33.4  $\mu\text{Sv}\cdot\text{h}^{-1}$ , we consider sub-acquisitions of  $\frac{3.3}{33.4} \times 3 \times 54 = 16$  s. For each measurement, the measurement time is  
 292 set in order to have at least 10 sub-acquisitions. For each sub-acquisition, the intensity (in ToT values) in the hotspot is calculated,  
 293 providing a distribution. The agreement with a Normal distribution is verified using the Shapiro-Wilk test [16]. From this  
 294 distribution, the mean value is calculated, and the associated uncertainty is estimated as twice the standard deviation ( $k=2$ ). The  
 295 intensities in the hotspots were evaluated over an integrated equivalent dose range extending from 83.2 nSv to 53.655  $\mu\text{Sv}$ , and  
 296 are illustrated in Figure 8. The results show that the response of Nanopix-v1, with Cs-137, to the previously mentioned integrated  
 297 equivalent dose is linear. Extrapolating the results from Figure 8, it is therefore possible to evaluate the equivalent integrated dose,  
 298 and the equivalent dose rate of a Cs-137 hotspot at the Nanopix-v1 from the intensity of the considered hotspot.

299 It is planned to evaluate this response over a wider range of integrated dose in future work, and additionally over a wider set of  
 300 radionuclides such as Am-241 and Co-60.

301

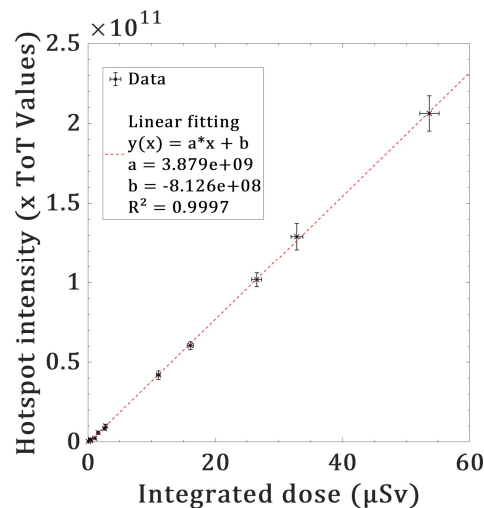

302

303

304

Figure 8: Hotspot intensity expressed in ToT Values versus integrated dose close to Nanopix-v1. The red dashed line represents the linear fit. Error bars are given 2 sigmas.

305

306 *C. In-situ measurement – ORANO La Hague.*

307 In this paragraph we present results obtained from in-situ measurements carried out with Nanopix-v1 at the nuclear materials  
 308 recycling facility at ORANO La Hague, France. These measurements were carried out on a powder plutonium oxide ( $\text{PuO}_2$ ) mixing  
 309 hopper. This mixing hopper, located inside a shielded cell, roughly consists in a steel wheel with a 1 m diameter and a thickness  
 310 of 50 cm with several blades aimed to mix the fresh  $\text{PuO}_2$  powder. The powders enter through the upper part of the hopper, and are  
 311 then mixed inside it. Once the powder is homogeneous, it is evacuated through a pipe located at the bottom of the hopper. The  
 312 mass of the hopper is regularly checked to ensure that the powder is being properly evacuated. However, it appears that sometimes  
 313 a portion of the powder remains blocked inside the hopper. To evacuate this powder, operators randomly strike the hopper with a  
 314 hammer. The equivalent dose rate at the glove ports is around  $240 \mu\text{Sv}\cdot\text{h}^{-1}$ , limiting the intervention time of the operators to about  
 315 ten minutes. The background noise in terms of equivalent dose rate in the shielded cell is around  $150 \mu\text{Sv}\cdot\text{h}^{-1}$ . The main purpose  
 316 of these measurements with Nanopix-v1 was to locate the position within a hopper where  $\text{PuO}_2$  powder had remained blocked,  
 317 preventing its operation. It should be noted that this application case is a real case and was not specifically set up for this work. It  
 318 illustrates a potential use case of interest involving the deployment of Nanopix-v1.

319 The first measurement involved localizing the blocked  $\text{PuO}_2$  in the mixing hopper. The measurement protocol is as follows:  
 320 Nanopix-v1 is positioned in front of the mixing hopper outside the shielded hot cell at a distance of one meter from the lead glass.  
 321 The measurement consisted of 400 frames of 1 s using the "mask/anti-mask" procedure, i.e., 200 frames of 1 s in mask and 200  
 322 frames of 1 s in anti-mask. ToT spectra and decoded images presented in this section are obtained using the methods described  
 323 respectively in paragraphs II.A.2) and II.A.3). Figure 9 shows the results of the first measurement: (a) the measured ToT spectrum  
 324 on which two areas are highlighted, corresponding to ToT values used for ToT discrimination; (b) the decoded image; (c) and (d)  
 325 show decoded images obtained using ToT discrimination, respectively, for the red and blue parts of the ToT spectrum. The crimson  
 326 square displayed on the different decoded images correspond to the field of view of the gamma camera.

327 In the ToT spectrum (Figure 10 (a)), two areas of interest are highlighted:

- 328 • A red part with ToT values between 0 and 300, including two peaks. Since Nanopix-v1 is not energy calibrated, it is not  
 329 possible to precisely convert those ToT values into energy. However, from the measured ToT spectrum of Am-241 shown  
 330 in Figure 4 (a), we can deduce that both these peaks correspond to energies lower than roughly 70 keV. We made the  
 331 assumption that these two peaks may originate partially from Am-241, Pu-241 daughter nuclide.
- 332 • A blue part corresponding to a Compton scattering zone, for which the time of measurement is insufficient to identify any  
 333 total absorption peaks. We made the assumption that events depositing ToT values in this part correspond to fresh  $\text{PuO}_2$   
 334 powder.

335 In the decoded image (Figure 10 (b)), a hotspot is located in the upper-right part of the mixing hopper. This hotspot corresponds  
 336 to the blocked  $\text{PuO}_2$  powder to be evacuated. Figure 9 (c) is the decoded image obtained using ToT discrimination. The events  
 337 used are those whose ToT values are in the red part of the ToT spectrum. Two hotspots are located, one in the center of the mixing  
 338 hopper, and a second one in the evacuation pipe. Those two hotspots correspond to "old"  $\text{PuO}_2$  powder that has not been correctly  
 339 evacuated from the mixing hopper. Figure 9 (d) shows the decoded image obtained by selecting events occurring in the blue part  
 340 of the ToT spectrum. One hotspot is located, and confirms that the hotspot located without any ToT discrimination corresponds to  
 341 the  $\text{PuO}_2$  to be evacuated.

342

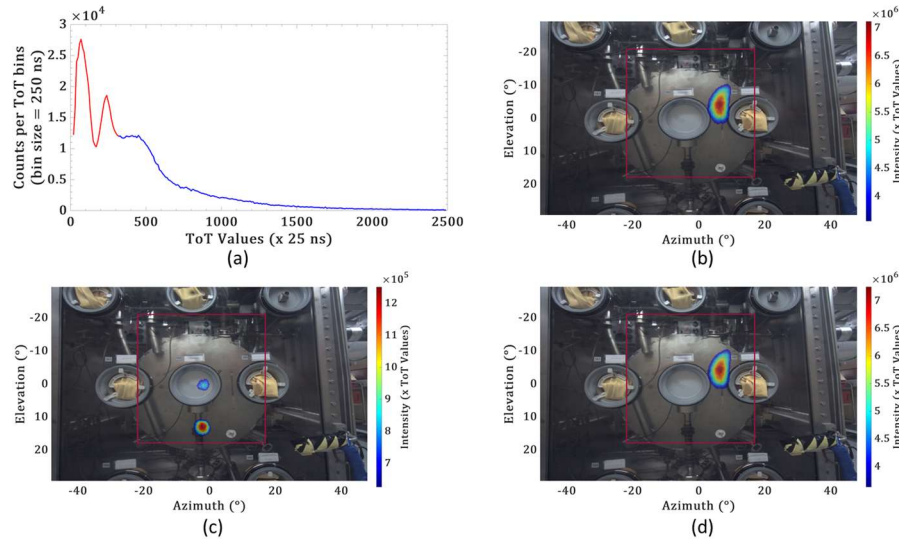

343  
 344 *Figure 9: Localisation of blocked PuO<sub>2</sub> powder inside a mixing hopper at the ORANO, La Hague site using Nanopix-v1. Nanopix-v1 is*  
 345 *positionned at a distance of 1 m, measurement consists in 200 frames in mask mode, and 200 frames in anti-mask mode. The duration of each*  
 346 *frame is 1 s. In (a) the measured ToT spectrum; (b) the decoded image without ToT discrimination; the decoded images obtained using ToT*  
 347 *spectral discrimination, selecting events whose deposited ToT are in the red part (c) and blue part (d) of the ToT spectrum (a). On each*  
 348 *decoded image, a threshold at 50 % of the maximum is applied.*

349  
 350 Once the blocked PuO<sub>2</sub> powder was located using Nanopix-v1, the operators struck the hopper with a hammer at the appropriate  
 351 spot to clear the blockage. A second measurement was then carried out to verify if the PuO<sub>2</sub> was successfully unblocked. The  
 352 measurement protocol remained the same as the one described for the first measurement. Figure 10 shows the results of the second  
 353 measurement: (a) the measured ToT spectrum on which two areas are highlighted, corresponding to ToT values used for ToT  
 354 discrimination; (b) the decoded image; (c) and (d) show decoded images obtained using ToT discrimination, respectively, for the  
 355 red and blue parts of the ToT spectrum. We can notice, by observing the field of view of the coded mask (represented by the  
 356 crimson square on Figure 10 (b), (c) and (d)), that Nanopix-v1 was not positioned exactly at the same place for this second  
 357 measurement. The interpretation of the ToT spectrum shown in Figure 10 (a) is the same as the one described for the first  
 358 measurement, and will not be discussed for the second measurement. In the decoded image presented in Figure 10 (b), we can see  
 359 that the hotspot is now in the bottom part of the hopper. We can deduce that the hammer strike on the hopper was efficient. On the  
 360 decoded image presented in Figure 10 (c), resulting from a ToT discrimination, selecting only events depositing ToT values in the  
 361 red part of the ToT spectrum, two hotspots are localised. The hotspot in the evacuation pipe is still at the same place, however the  
 362 one in the center of the hopper is not here anymore. A second hotspot is visible in the lower part outside the hopper, and was not  
 363 visible in Figure 9 (c). This is simply because as previously mentioned, Nanopix-v1 has been moved between the first measurement  
 364 and the second measurement, and this part was not in the field of view of the coded-aperture in the first measurement. Figure 9 (d)  
 365 shows the decoded image obtained by selecting events occurring in the blue part of the ToT spectrum. By comparing decoded  
 366 image from Figure 9 (b) and Figure 9 (d), we can deduce that the hotspot shown in Figure 9 (b) is actually composed of two  
 367 hotspots, one in the evacuation pipe, and the PuO<sub>2</sub> powder in the bottom part of the hopper.  
 368  
 369

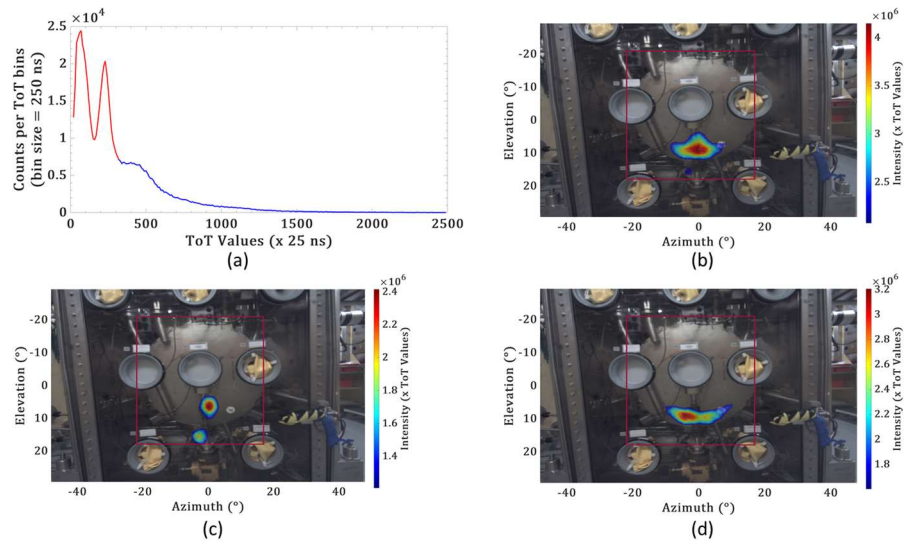

370  
 371 *Figure 10: Localisation of PuO<sub>2</sub> powder inside a mixing hopper at the ORANO, La Hague site using Nanopix-v1 after striking the mixing*  
 372 *hopper with a hammer to unstuck the powder. Nanopix-v1 is positionned at a distance of 1 m, measurement consists in 200 frames in mask*  
 373 *mode, and 200 frames in anti-mask mode. The duration of each frame is 1 s. In (a) the measured ToT spectrum; (b) the decoded image without*  
 374 *ToT discrimination; the decoded images obtained using ToT spectral discrimination, selecting events whose deposited ToT are in the red part*  
 375 *(c) and blue part (d) of the ToT spectrum (a). On each decoded image, a threshold at 50 % of the maximum is applied.*

376

377

#### IV. CONCLUSIONS AND PERSPECTIVES

378 In this work, we have developed a miniaturized coded-aperture gamma imager, Nanopix-v1, with dimensions of  $7.9 \times 4.3 \times 5.1$  cm<sup>3</sup>,  
 379 for a total mass of 268 g. Its performances in terms angular resolution and minimum measurement time have been evaluated on a  
 380 set of commonly encountered radionuclides placed in the center of the field of view, covering a gamma energy range from 59.5 keV  
 381 up to 1.33 MeV. We have also demonstrated the capability of the Nanopix-v1 to evaluate the equivalent integrated dose, and the  
 382 equivalent dose rate of a Cs-137 hotspot at the Nanopix-v1 from the intensity of the considered hotspot. Eventually, in-situ  
 383 measurements at the ORANO La Hague site have been performed with Nanopix-v1, showing the performances of Nanopix-v1 on  
 384 a real use case.

385 A measurement campaign is planned with Nanopix-v1 on a dedicated installation to evaluate the performances in terms of angular  
 386 resolution and minimum measurement time over a wider set of positions, particularly for off-axis sources. Future work will also  
 387 be focused on energy calibrating the detector block, and evaluating the response in terms of Nanopix-v1 of dose rate on a larger  
 388 set of radionuclides. A special effort will also be made in order to fully automatize the Nanopix-v1, integrating the rotation of the  
 389 coded-aperture, and an embedded electronics for processing.

390

391

#### V. REFERENCES

- 392 [1] F. Carrel, R.A. Khalil, S. Colas, D. De Toro, G. Ferrand, E. Gaillard-Lecanu, M. Gmar, D. Hameau, S. Jahan, F. Laine, A.S.  
 393 Lalleman, F. Lemasle, C. Mahé, J.E. Maurer, N. Mena, S. Normand, H. Onillon, N. Saurel, V. Schoepff, H. Toubon,  
 394 GAMPIX: A new gamma imaging system for radiological safety and homeland security purposes, IEEE Nucl. Sci. Symp.  
 395 Conf. Rec. (2012) 4739–4744. <https://doi.org/10.1109/NSSMIC.2011.6154706>.  
 396 [2] H. Lemaire, R.A. Khalil, K. Amgarou, J.C. Angélique, F. Bonnet, D. De Toro, F. Carrel, O. Giarmana, M. Gmar, N. Mena,  
 397 Y. Menesguen, S. Normand, A. Patoz, V. Schoepff, P. Talent, T. Timi, Implementation of an imaging spectrometer for  
 398 localization and identification of radioactive sources, Nucl. Instrum. Methods Phys. Res. Sect. Accel. Spectrometers Detect.  
 399 Assoc. Equip. 763 (2014) 97–103. <https://doi.org/10.1016/j.nima.2014.05.118>.  
 400 [3] G. Amoyal, V. Schoepff, F. Carrel, V. Lourenco, D. Lacour, T. Branger, Metrological characterization of the GAMPIX  
 401 gamma camera, Nucl. Instrum. Methods Phys. Res. Sect. Accel. Spectrometers Detect. Assoc. Equip. 944 (2019) 162568.  
 402 <https://doi.org/10.1016/j.nima.2019.162568>.  
 403 [4] K. Amgarou, A. Patoz, D. Rothan, N. Mena, iPIX: A New Generation Gamma Imager for Rapid and Accurate Localization  
 404 of Radioactive Hotspots, 2014.  
 405 [5] G. Montemont, P. Bohuslav, J. Dubosq, B. Feret, O. Monnet, O. Oehling, L. Skala, S. Stanchina, L. Verger, G. Werthmann,  
 406 NuVISION: A Portable Multimode Gamma Camera based on HiSPECT Imaging Module, 2017 IEEE Nucl. Sci. Symp.  
 407 Med. Imaging Conf. NSSMIC 2017 - Conf. Proc. (2018) 6–8. <https://doi.org/10.1109/NSSMIC.2017.8532713>.

- 408 [6] C.G. Wahl, W.R. Kaye, W. Wang, F. Zhang, J.M. Jaworski, A. King, Y.A. Boucher, Z. He, The Polaris-H imaging  
409 spectrometer, *Nucl. Instrum. Methods Phys. Res. Sect. Accel. Spectrometers Detect. Assoc. Equip.* (2014).  
410 <https://doi.org/10.1016/j.nima.2014.12.110>.
- 411 [7] Z. Vykydal, J. Jakubek, USB Lite — Miniaturized readout interface for Medipix2 detector, *Nucl. Inst Methods Phys. Res.*  
412 *A* 633 (2011) S48–S49. <https://doi.org/10.1016/j.nima.2010.06.118>.
- 413 [8] X. Llopart, R. Ballabriga, M. Campbell, L. Tlustos, W. Wong, Timepix, a 65k programmable pixel readout chip for arrival  
414 time, energy and/or photon counting measurements, *Nucl. Instrum. Methods Phys. Res. Sect. Accel. Spectrometers Detect.*  
415 *Assoc. Equip.* 581 (2007) 485–494. <https://doi.org/10.1016/j.nima.2007.08.079>.
- 416 [9] D. Maneuski, V. Astromskas, E. Fröjd, E.N. Gimenez, J. Marchal, V. O’Shea, G. Stewart, N. Tartoni, Imaging and  
417 spectroscopic performance studies of pixellated CdTe Timepix detector, *JINST* 7 (2012). [https://doi.org/10.1088/1748-](https://doi.org/10.1088/1748-0221/7/01/C01038)  
418 [0221/7/01/C01038](https://doi.org/10.1088/1748-0221/7/01/C01038).
- 419 [10] S.R. Gottesman, E.E. Fenimore, New family of binary arrays for coded aperture imaging, *Appl. Opt.* 28 (1989) 4344.  
420 <https://doi.org/10.1364/ao.28.004344>.
- 421 [11] E. Caroli, J. B. Stephen, G. Di Cocco, L. Natalucci, A. Spizzichino, Coded aperture imaging in X- and gamma-ray  
422 astronomy, 1987. <https://doi.org/10.1007/BF00171998>.
- 423 [12] S.R. Gottesman, A. Isser, G.W. Gigioli, N. Grumman, E. Systems, W.N. Rd, Adaptive coded apertures : bridging the gap  
424 between non-diffractive and diffractive imaging systems, 7818 (2010) 1–9. <https://doi.org/10.1117/12.863032>.
- 425 [13] J. Jakubek, Precise energy calibration of pixel detector working in time-over-threshold mode, *Nucl. Instrum. Methods Phys.*  
426 *Res. Sect. Accel. Spectrometers Detect. Assoc. Equip.* 633 (2011) S262–S266. <https://doi.org/10.1016/j.nima.2010.06.183>.
- 427 [14] M. Ester, H.-P. Kriegel, J. Sander, X. Xu, A Density-Based Algorithm for Discovering Clusters in Large Spatial Databases  
428 with Noise, in: *Proc. Second Int. Conf. Knowl. Discov. Data Min.*, AAAI Press, 1996: pp. 226–231.
- 429 [15] P.D.W. Kirk, M.P.H. Stumpf, Gaussian process regression bootstrapping: exploring the effects of uncertainty in time course  
430 data., *Bioinforma. Oxf. Engl.* 25 (2009) 1300–1306. <https://doi.org/10.1093/bioinformatics/btp139>.
- 431 [16] S.S. Shapiro, M.B. Wilk, An Analysis of Variance Test for Normality (Complete Samples), *Biometrika* 52 (1965) 591–611.  
432 <https://doi.org/10.2307/2333709>.
- 433