



HAL
open science

Electro-precipitation of actinides on boron-doped diamond thin films for solid sources preparation for high-resolution alpha-particle spectrometry

Quang-Thuan Tran, Sylvie Pierre, Jacques de Sanoit, Michal Pomorski, Philippe Bergonzo

► To cite this version:

Quang-Thuan Tran, Sylvie Pierre, Jacques de Sanoit, Michal Pomorski, Philippe Bergonzo. Electro-precipitation of actinides on boron-doped diamond thin films for solid sources preparation for high-resolution alpha-particle spectrometry. *Applied Sciences*, 2019, 9 (7), pp.1473. 10.3390/app9071473 . cea-04550184

HAL Id: cea-04550184

<https://cea.hal.science/cea-04550184>

Submitted on 17 Apr 2024

HAL is a multi-disciplinary open access archive for the deposit and dissemination of scientific research documents, whether they are published or not. The documents may come from teaching and research institutions in France or abroad, or from public or private research centers.

L'archive ouverte pluridisciplinaire **HAL**, est destinée au dépôt et à la diffusion de documents scientifiques de niveau recherche, publiés ou non, émanant des établissements d'enseignement et de recherche français ou étrangers, des laboratoires publics ou privés.

Article

Electro-Precipitation of Actinides on Boron-Doped Diamond Thin Films for Solid Sources Preparation for High-Resolution Alpha-Particle Spectrometry

Quang-Thuan Tran ^{1,2,*}, Sylvie Pierre ³, Jacques de Sanoit ¹, Michal Pomorski ¹ and Philippe Bergonzo ^{4,5,6,*} 

¹ CEA-LIST, Diamond Sensor Laboratory (LCD), 91191 Gif-sur-Yvette, France; mysterjack@hotmail.com (J.d.S.); michal.pomorski@cea.fr (M.P.)

² Vietnam Academy of Science and Technology (VAST), Center for Research and Technology Transfer (CRETECH), 18 Hoang Quoc Viet Road, 100000 Hanoi, Vietnam

³ CEA-LIST, Laboratoire National Henri Becquerel (LNE-LNHB), 91191 Gif-sur-Yvette, France; sylvie.pierre@cea.fr

⁴ CEA-LIST, 91191 Gif-sur-Yvette, France

⁵ Electronic and Electrical Engineering Department, University College London, London WC1E 7JE, UK

⁶ Seki Diamond Systems, San-Jose, CA 95131, USA

* Correspondence: tranquangthuan2008@gmail.com (Q.-T.T.); pbergonzo@sekidiamond.com (P.B.)

Received: 19 February 2019; Accepted: 3 April 2019; Published: 8 April 2019



Featured Application: We propose a novel approach enabling the fabrication of high resolution alpha sources with interest for a range of spectroscopy applications.

Abstract: In this work, we investigate a novel approach to prepare high-performance alpha-particle solid sources fabricated on diamond thin support layers, offering the properties of diamond such as a low-Z material with corrosion and mechanical hardness. As-prepared solid sources onto boron-doped-diamond (BDD) substrate exhibited high performance of the autoradiography and spectroscopic resolution at the level of other more conventional materials such as stainless steel. A straightforward precipitation process in the Na₂SO₄ or NaNO₃ simple electrolytes under mild experimental conditions with a low current of several mA.cm⁻² were successfully developed onto BDD substrates for deposition of single ²⁴¹Am as well as ²³⁹Pu, ²⁴¹Am, and ²⁴⁴Cm mixed radionuclides. The results demonstrate that solid sources deposited onto such BDD substrates can match the performance of those prepared onto stainless steel substrates with excellent uniformity and high-resolution spectroscopy, together combining the robustness, chemical resilience, and X-ray transparency of the diamond. Alpha-particle spectra exhibiting a low full width at half maximum (FWHM) of 12.5 keV at the energy of 5.485 MeV (²⁴¹Am) could be practically obtained for BDD substrates.

Keywords: low-Z; corrosion hard alpha sources; BDD thin films; actinides electro-precipitation; high-resolution alpha-particle spectrometry

1. Introduction

Alpha-particle spectroscopy is commonly used for applications in various fields such as nuclear [1–4], environmental [5–8], artistic [9,10], and biological [11–14] samples. Conventional approaches for the preparation of alpha-particle sources generally include (i) radiochemical separation and purification [15,16], (ii) preparation of weightless and thin solid source onto a suitable backing material [17–19], and (iii) alpha-particle spectroscopic measurements under vacuum conditions using solid-state semiconductor detectors [20–24]. High-resolution alpha-spectrometry is always needed

for qualitative identification and accurate determination of the alpha-emitting radioactive isotopes concerned. For this purpose, the preparation of low mass solid sources with high uniformity that reveals a significant feature is still today extensively investigated. Conventional approaches include vacuum sublimation, drop-casting, co-precipitation, and electro-precipitation [16,17,21,25,26]. While drop-casting generally allows relatively poor resolution with a large low-energy tail contribution, vacuum sublimation requires an elaborated set-up and gives a relatively poor deposition yield, and co-precipitation is very time-consuming since the sample must be pretreated using chromatography for separation and purification of the actinides. Finally, electro-precipitation represents a more straightforward and spreading route allowing a quantitative alpha-emitter deposition with a high-quality solid radioactive source deposited in the form of a very thin and uniform coating.

With regard to electro-precipitation techniques, this method was firstly developed in the early 1950s [27,28] and extensively explored since, following the works published in 1972 by Puphal et al. [29] and Talvitie [30] using ammonium salt with various counter anions as electrolytes. The main principle of this method is based on the use of a negative current for depleting water into OH^- hydroxyl ions generated close to the cathode electrode which subsequently reacts with highly and positively charged actinide ions (Ac^{n+}) affording actinide hydroxides, very insoluble compounds, precipitated onto cathode electrode surfaces. The electrolyte generally represents a large number of complexing anions (Cl^- , ClO_4^- , SO_4^{2-} , HSO_4^- , NO_3^-) and acidic medium to prevent dramatic hydrolysis of actinide ions into actinide hydroxides in bulk solution [31,32]. Otherwise, experimental conditions represent significant features to obtain a quantitative deposition of radionuclides. The work published by Puphal et al., [29] demonstrated that using optimized conditions, e.g., ammonium oxalate-chloride mixture, pH value of 2, a current density of $400 \text{ mA}\cdot\text{cm}^{-2}$, and typical 1 h of precipitation onto conductive substrates from $5\text{--}8 \text{ cm}^2$, could enable high precipitation yields of more than 98% for several different actinides (^{230}Th , ^{237}Np , ^{239}Pu , ^{241}Am , and ^{244}Cm). High-resolution alpha sources can be obtained with typically full width at half maximum (FWHM) values of e.g., 24 keV for ^{241}Am . Conventional substrates are metals, and often stainless steel. In the precipitation process, another thing should be remarked on, namely the presence of interfering metal ions such as iron, aluminum, natural thorium, and zirconium, etc. Puphal et al. [29] demonstrated that using fluoride-complexing anions enable the overcoming of such interference. However, the use of such fluoride anions dramatically decreases precipitation efficiency proved by Talvitie's work.

For the electrochemical precipitation process, some works proposed changing composition and pH value of the electrolytes: (i) Talvitie demonstrated that ammonium perchlorate or sulfate (1 M) and a very acidic pH value exhibited more suitable electrolytes, prompting almost quantitative electro-precipitation up to 99.8% efficiency for various radionuclides ^{230}Th , ^{232}U , ^{239}Pu , and ^{241}Am using 2 h of deposition duration onto a cathode area of 2 cm^2 [30]; (ii) another approach resulted from simple sodium sulfate or sodium sulfate/hydrogen sulfate mixture, which exhibited robust electrolytes enabling the stabilization of pH value even when using relatively high current densities of several $100\text{s mA}\cdot\text{cm}^{-2}$ and thus obtaining high efficiencies of more than 90% for different radionuclides ^{230}Th , ^{237}Np , ^{239}Pu , ^{241}Am , and ^{244}Cm and thus pH values could be tolerant from 1.5–4.5 [33,34]. Still, one limitation is arising, and is necessary for the process of using conductive materials with high corrosion resilience. Several metals offer these properties, several may be noble metals, and thus expensive. Furthermore, they always exhibit a high atomic number, and for some applications in nuclear facilities the metal gets activated and becomes radioactive waste.

Inspired by these electro-precipitation methods, our group has developed an innovative device called "ActiFind" combining the electrochemistry of a thin synthetic layer of conductive boron-doped diamond (BDD), coupled with the radiometric detector made e.g., of silicon that now allows the direct monitoring of alpha-particles in aqueous media using actinide deposition at a low current of several $\text{mA}\cdot\text{cm}^{-2}$ [35]. Such innovative device presents a high benefit for fast and on-field monitoring alpha-activity in nuclear and environmental samples due to direct deposition of radionuclide onto radiometric detector through a diamond thin layer. Furthermore, this work demonstrated

that multi-actinides including ^{239}Pu , ^{241}Am , and ^{244}Cm could be successfully deposited onto the diamond/silicon sensor at high electro-precipitation yields [36]. Here, the diamond layers used were fabricated using MicroWave Plasma-Enhanced Chemical Vapor Deposition (MWPECVD), where thin diamond layers, so-called nanocrystalline diamond (NCD), can be synthesized using methane at low cost. It is to be noted that diamond is generally insulating, but can be easily doped during growth by the addition of boron impurities, to become BDD. In the current work, we extend the use of diamond as a substrate for electro-precipitating actinide elements for the preparation of spectroscopic alpha-particle sources based on BDD, a substrate that exhibits high corrosion hardness as well as a low atomic number.

2. Materials and Methods

2.1. Chemical Products

All chemicals (NaNO_3 , Na_2SO_4 , NaOH , HNO_3 , and H_2SO_4) were purchased from Sigma Aldrich. Actinides stock solutions of ^{239}Pu ($205.2 \text{ Bq}\cdot\text{mL}^{-1}$), ^{241}Am ($238.4 \text{ Bq}\cdot\text{mL}^{-1}$), and ^{244}Cm ($165.2 \text{ Bq}\cdot\text{mL}^{-1}$) were supplied by the LNHB (Laboratoire National Henri Becquerel, Gif-sur-Yvette, France). Their activities were measured using liquid scintillation with Ultimagold (Packard) as scintillation cocktail. The pH value of the electrolyte solution was adjusted using diluted solutions of HNO_3 , H_2SO_4 , NaOH or 2% ammonia solution.

2.2. Electro-Precipitation Materials

BDD substrates with dimensions of $2 \times 2 \text{ cm}^2$ were fabricated with thicknesses of 400 to 500 nm. The BDD layers are grown using conventional CH_4 in H_2 mixture in a microwave high-density plasma, grown after dense seeding on Si substrates. The material exhibits a nanocrystalline nature, with grain sizes of the order of a few tens of nm. Such BDD electrodes have been used for a broad range of electrochemical applications aimed at the detection of analytes in complex media, such as chemicals in sea water [37], neurotransmitters in physiological serums [38], biofluids in urine [39], or a broad range of applications [37,40–44]. Doping of the layers was tuned at $2 \times 10^{21} \text{ at}\cdot\text{cm}^{-3}$ for optimal electrochemical performance [45]. Bare BDD electrodes are used, i.e., with no particular surface functionalization, as promoted by the ability to clean the surface in complex media [39,46,47]. Electrochemical cells investigated are similar to those used and described in [36]. They are composed of a planchet (here either stainless steel or BDD substrates), and put on a stainless steel support on which an acrylic glass cell equipped with a plastic seal is screwed, as depicted in Figure 1. The estimated planchet exposed area of the cathode is of about 1.2 cm^2 and a platinum pin is used as the anode. Electrolyte solutions are homogenized using a mechanical stirring system composed of a mechanical rotator (rotating rate of 1500 rpm) on which a plastic disposable coffee stirrer is connected.

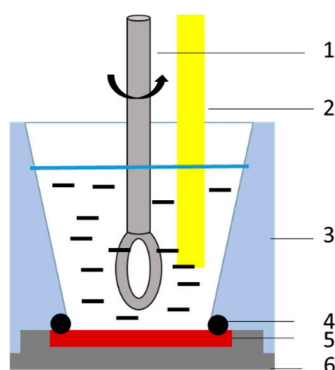

Figure 1. Electro-precipitation cell: (1) plastic coffee stirrer connected to a mechanic rotating system; (2) platinum anode; (3) glass cell; (4) O ring plastic seal; (5) stainless steel or BDD planchet cathode; (6) stainless steel support with an electrical contact.

2.3. Electro-Precipitation Process

Before the electro-precipitation process, BDD and stainless steel substrates were successively sonicated in deionized H₂O and acetone for 5 min. The electro-precipitation experiments were carried out using a duration from 15–120 min and a very low current density of several mA.cm⁻² in an aqueous solution of 0.3 M Na₂SO₄ or 0.3 M NaNO₃ electrolyte solution (18 mL of total volume) in which 25 µL of stock solution (a single or mixture of actinides ²⁴¹Am, ²³⁹Pu, and ²⁴⁴Cm) was introduced. The pH values of about 4 were chosen for Na₂SO₄ electrolyte. While this value of about 3 was used NaNO₃ electrolyte due to the increase of the pH during electro-precipitation [36]. There are some minimum values for current density to generate a hydroxide layer for precipitation as actinide hydroxide compounds [48]. Our previous study demonstrated that the current density should be above 3 mA.cm⁻² and 1 mA.cm⁻² for NaNO₃ pH 3 and Na₂SO₄ pH 4 electrolytes respectively [36]. The radioactivity corresponding to 25 µL of each stock solution was calculated at 5.96, 5.13 and 4.40 Bq for ²⁴¹Am ²³⁹Pu and ²⁴⁴Cm, respectively. The pH of electrolyte solutions was carefully adjusted to a suitable value by some droplets of diluted solutions of HNO₃, H₂SO₄, and NaOH. Before switching off the current, the pH of electrolyte solutions was adjusted to reach basic values at pH 9–10 using NH₃ solution (2%).

2.4. Autoradiography

The FUJIFILM BAS-1800II instrument is used as a bio-imaging analyzer for autoradiography with an imaging plate (IP). It consists of a fast phosphor IP exposed to the radioactive source. The sensitivity of the IP provides a highly efficient, uniform, and sensitive detection system. It is used to check the homogeneity of the deposited source.

2.5. Alpha-Particle Spectrometry Measurement

High-resolution alpha-particle spectra were recorded under vacuum (Canberra alpha spectrometer model 7401) equipped with a passivated implanted planar silicon (PIPS) detector (active area of 25 mm²). This device allows obtaining a spectroscopic resolution of 12 KeV at the energy of 5.485 MeV for ²⁴¹Am standard. Alpha-particle spectroscopy for a solid source exhibiting radioactivity as low as a few Bq can be practically achieved within 3 days and with a counting statistic uncertainty close to 1%. The spectra analysis is processed using Genie 2000 software (Canberra).

2.6. Alpha-Particle Activity Measurements

Radioactivity measurements were performed using a defined solid-angle counting geometry consisting of a vacuum chamber with a silicon semiconductor detector (Canberra PD 2000-40-300 AM) connected to an electronic device. The electronic device is composed of a preamplifier, an amplifier, and an analog-to-digital converter (model ASPEC from ORTEC). The distance between the diagram (which radius is measured with an uncertainty of 0.01%) in front of the detector and the source was measured with an uncertainty of 0.03%. The spectra are analyzed using the MAESTRO software. In this chamber, the uncertainty of the geometrical factor is negligible in comparison with the main uncertainty component, which comes from the counting statistic estimated below 1.2%.

3. Results and Discussion

3.1. Preparation of the Alpha-Particle Solid Source onto BDD Substrates

3.1.1. Uniformity of Solid Sources

The ²⁴¹Am compound was used as a typical radioactive source for regarding how ²⁴¹Am layers were deposited onto BDD substrates and the effect of either Na₂SO₄ or NaNO₃ electrolyte solution was also regarded. First, in the Na₂SO₄ electrolyte, the autoradiography image demonstrated that the deposition of the ²⁴¹Am was coated onto the entire BDD substrate (in Figure 2A). The alpha-activity derived from autoradiographs exhibited that ²⁴¹Am was deposited on the whole substrates in which

radioactivity in the center is slightly more concentrated than at the border of substrates. Such a result could be explained by the fact that the mechanical stirring system representing an oval shape produces a higher mass transport of the center than the border and thus making ^{241}Am layer thicker. A very similar quality of the ^{241}Am layer could be achieved on stainless steel substrates, here used as a comparison (Figure 2B). Such a result demonstrated that a radioactive layer deposited BDD substrate has a good uniformity and same quality as stainless steel.

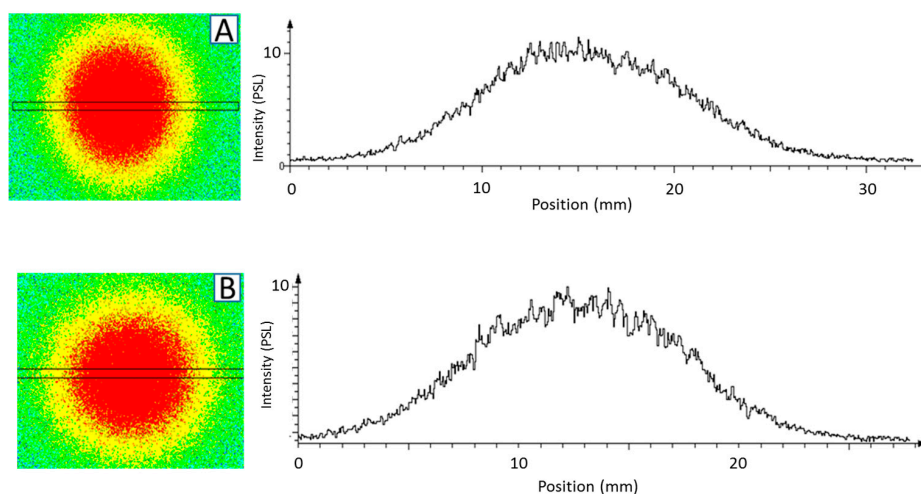

Figure 2. Autoradiographs (left) and profile of radioactivity distributions (right) of the ^{241}Am alpha sources: (A) diamond and (B) stainless steel substrates. Electro-precipitation conditions: 0.3 M Na_2SO_4 pH 3.97 electrolyte + 5.96 Bq ^{241}Am , current density = $8 \text{ mA}\cdot\text{cm}^{-2}$, $t = 90 \text{ min}$.

Secondly, electro-precipitation in the NaNO_3 electrolyte enables the production of high-quality sources representing a high homogeneity for both BDD and stainless steel substrates (Figure 3A,B). In this case, it should be noted that the alpha-activity distribution is more homogenized with respect to that prepared in Na_2SO_4 solution. It was proposed that in Na_2SO_4 , the electrolysis of water generates hydroxyl ions with more hydrogen gas while in NaNO_3 electrolysis of nitrate is preferential and thus does not form hydrogen gas. Such bubbling of the hydrogen gas could be the origin of the effect of the radioactive distribution.

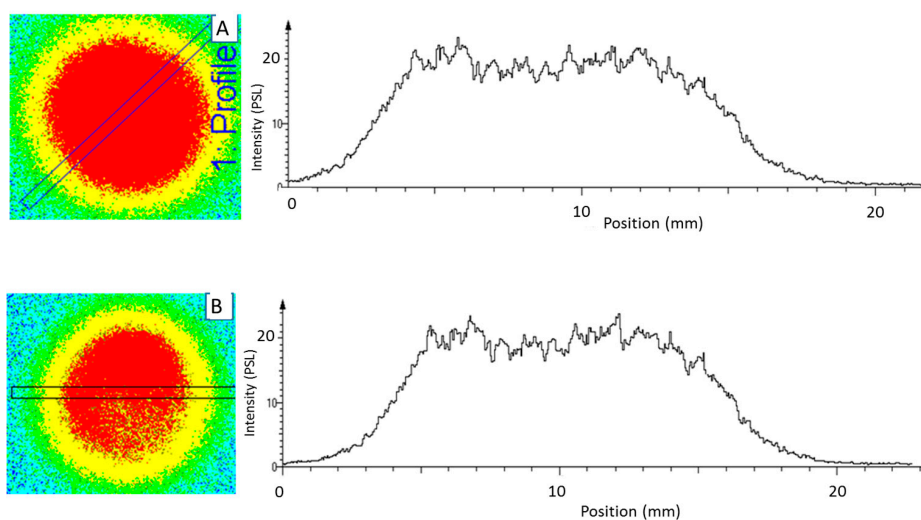

Figure 3. Autoradiographs (left) and profile of radioactivity distributions (right) of the ^{241}Am alpha sources: (A) diamond and (B) stainless steel substrates. Electro-precipitation conditions: 0.3 M Na_2SO_4 pH 3.0 electrolyte + 5.96 Bq ^{241}Am , current density = $3.3 \text{ mA}\cdot\text{cm}^{-2}$, $t = 90 \text{ min}$.

Furthermore, we also investigated how the radioactive source has grown during the electro-precipitation onto the BDD substrate. At this state, electro-precipitation for mixtures of ^{239}Pu , ^{241}Am , and ^{244}Cm were also carried out in Na_2SO_4 as well as NaNO_3 electrolyte solutions. First, an autoradiograph displays that the precipitation in Na_2SO_4 solution is preferentially deposited in the center and then extended to the border of BDD substrate following precipitation duration from 15–120 min (see in Figure 4). It was assumed that the radioactivity was first deposited in the center due to higher mass transport and then extended to the near region onto a BDD substrate that has a more conductive layer than actinide oxides layer. This observation explained the radioactive distribution as mentioned above. It should be noted that the radioactive source layers in NaNO_3 electrolyte were grown in the same way as that in Na_2SO_4 electrolyte (Figure 5).

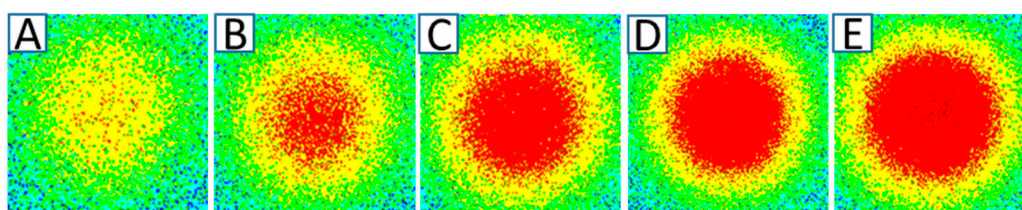

Figure 4. Autoradiographs of the mixture of ^{239}Pu , ^{241}Am , and ^{244}Cm alpha sources electro-precipitated in 0.3 M Na_2SO_4 at pH 3.50 electrolyte solutions with a current density of $5 \text{ mA}\cdot\text{cm}^{-2}$ onto BDD substrates at different precipitation times: (A) 15 min; (B) 30 min; (C) 60 min; (D) 90 min; and (E) 120 min.

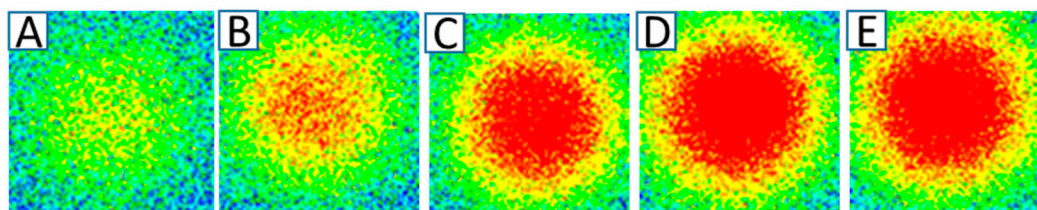

Figure 5. Autoradiographs of the mixture of ^{239}Pu , ^{241}Am , and ^{244}Cm alpha sources electro-precipitated in 0.3 M NaNO_3 at pH 3 electrolyte solutions with a current density of $2.5 \text{ mA}\cdot\text{cm}^{-2}$ onto BDD substrate at different precipitation times: (A) 15 min; (B) 30 min; (C) 60 min; (D) 90 min; and (E) 120 min.

3.1.2. Alpha-Particle Spectroscopy

To check the quality of prepared solid sources, alpha-particle spectrometry was recorded and the FWHM value was estimated. All FWHM values of ^{241}Am sources are given in Table 1. It shows that ^{241}Am spectra displayed a high resolution with FWHM values varying from 13.2–14.5 keV at the energy of 5.485 MeV for ^{241}Am source onto BDD substrate. These values are very close to those of stainless steel e.g., 13.8 KeV and of ^{241}Am standard source of 12 keV. This result confirms that (i) BDD could be used as an alternative material for alpha-particle solid-source preparation, and (ii) NaNO_3 electrolyte solution could also be used as an alternative electrolyte with respect to Na_2SO_4 electrolyte to enable high-resolution alpha-particle spectrometry. Typical alpha-particle spectra displays are of very high resolution and thus enable identification of very distinct peaks attributed to four alpha energies of the ^{241}Am sources at 5388, 5443, 5485.6, and 5544 MeV (Figure 6A). Furthermore, with such spectroscopic resolution, a clear identification of actinides mixture (^{239}Pu , ^{241}Am , and ^{244}Cm) could be practically achieved for solid sources prepared onto BDD substrates using Na_2SO_4 as well as NaNO_3 electrolyte solutions (see in Figure 6B).

Table 1. FWHM of 5.96 Bq ^{241}Am electro-precipitated for $t = 90$ min: (1) 0.3 M Na_2SO_4 pH 3.97 electrolyte, current density = $8 \text{ mA}\cdot\text{cm}^{-2}$, and (2) 0.3 M Na_2SO_4 pH 3.0 electrolyte, current density = $3.3 \text{ mA}\cdot\text{cm}^{-2}$, $t = 90$ min.

Experiment	Electrolyte	FWHM (keV)		
		Stainless Steel	BDD	Standard
1	Na_2SO_4	13.8	13.2	12
2	NaNO_3	12.5	14.5	12

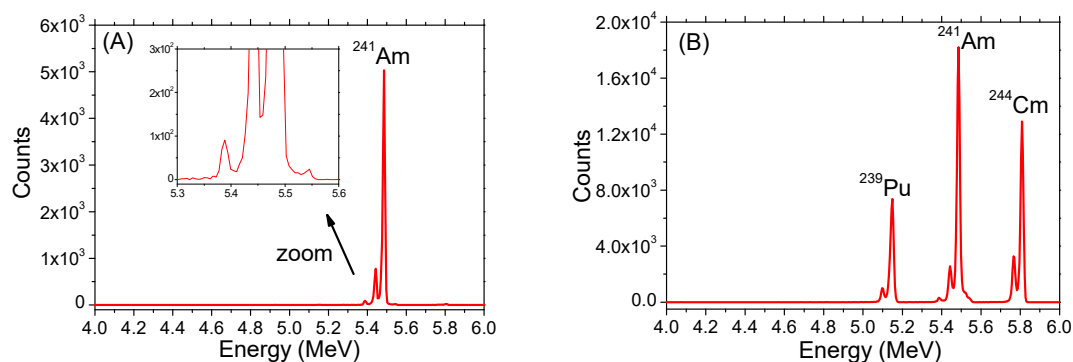

Figure 6. Typical alpha-particle spectra: (A) ^{241}Am 5.96 Bq electro-precipitated in 0.3 M Na_2SO_4 electrolyte solution at pH 3.85 with a current density of $8 \text{ mA}\cdot\text{cm}^{-2}$ onto BDD during 90 min; (B) mixture of ^{239}Pu 5.13 Bq, ^{241}Am 5.96 Bq and ^{244}Cm 4.40 Bq electro-precipitated onto doped diamond substrate for 120 min in 0.3 M Na_2SO_4 pH 4.0 electrolyte solution with a current density of $5 \text{ mA}\cdot\text{cm}^{-2}$.

3.2. Electro-Precipitation Efficiency

The alpha-particle activity of ^{241}Am deposited was further measured. This value was calculated to 49.7 and 59.7% for ^{241}Am deposited in Na_2SO_4 electrolyte solutions onto stainless steel and BDD respectively (see in Table 2, row a). This slight difference in the precipitation yield could be explained by the fact that there is a slight pH difference (3.97 vs. 3.85) for stainless steel and diamond, respectively. With the same current density applied, a less acidic pH induces a thicker hydroxyl layer, making actinide diffusion lesser on the cathode and thus lower precipitation efficiency [48]. Very close electro-precipitation efficiency values (71 and 70%) could be achieved in NaNO_3 electrolyte for BDD and stainless steel substrates (see in Table 2, row b). Generally, a slightly higher efficiency is observed when NaNO_3 is used with respect to Na_2SO_4 ; even when the precipitation processes are onto either diamond or stainless steel substrate (Table 2) or even onto BDD film combined with a silicon detector in an ActiFind device [35]. This result confirms that BDD can be used as an alternative material for efficient electro-precipitation and that NaNO_3 electrolyte enables a higher efficiency than Na_2SO_4 solution.

Table 2. Precipitation yields of 5.96 Bq ^{241}Am electro-precipitated for $t = 90$ min: (a) 0.3 M Na_2SO_4 electrolyte pH 3.97 (stainless steel) or 3.85 (diamond), current density = $8.0 \text{ mA}\cdot\text{cm}^{-2}$, and (b) 0.3 M Na_2SO_4 pH 3.0 electrolyte, current density = $3.3 \text{ mA}\cdot\text{cm}^{-2}$, $t = 90$ min.

Experiment	Electrolyte	Precipitation Yields (%)	
		Stainless Steel	Diamond
a	0.3 M Na_2SO_4	49.7	58.7
b	0.3 M NaNO_3	71	70

Furthermore, electro-precipitation of actinides mixtures (^{239}Pu , ^{241}Am , and ^{244}Cm) was also investigated onto BDD substrates for varying durations. Precipitation efficiencies were displayed in Figure 7 for both Na_2SO_4 and NaNO_3 electrolytes. The result demonstrated that the precipitation efficiency values are approximately similar for ^{241}Am and ^{244}Cm in either Na_2SO_4 or NaNO_3 and are slightly higher than for ^{239}Pu . The low precipitation yield of ^{239}Pu could be attributed to the complex chemistry of Pu existing in many oxidation states (III, IV, V, VI) in solution. Again, the result demonstrated a slightly more efficient precipitation in NaNO_3 than in Na_2SO_4 electrolyte. The precipitation efficiency could be improved up more than 80% for ^{241}Am and ^{244}Cm and more than 40% for ^{239}Pu in NaNO_3 electrolyte solution after 2 h of precipitation.

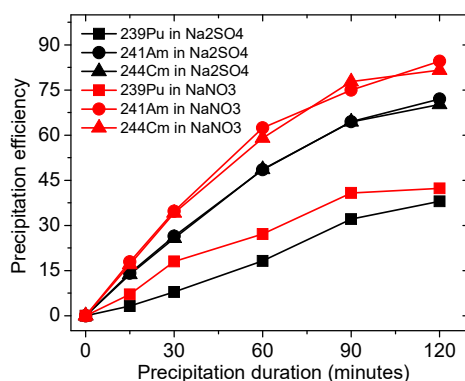

Figure 7. Electro-precipitation kinetic of the mixture (^{239}Pu , ^{241}Am and ^{244}Cm) in: (i) 0.3 M Na_2SO_4 at pH 3.5 electrolyte solution with a current density of $5 \text{ mA}\cdot\text{cm}^{-2}$ and (ii) 0.3 M NaNO_3 at pH 3.0 electrolyte solution with a current density of $2.5 \text{ mA}\cdot\text{cm}^{-2}$.

4. Conclusions

This work demonstrated that BDD substrate could be used as an alternative material for the preparation of high-efficiency and high-quality radioactive sources with a high-resolution alpha-particle spectroscopy. Notably, its inherent corrosion hardness could be a valuable behavior for practical applications in the nuclear industry using highly acidic solutions [49,50]. The obtained FWHM value of 13.2 KeV at 5.485 MeV for BDD substrate is close at the state-of-art spectroscopic measurement system e.g., 12 KeV for ^{241}Am standard, confirms the benefit of the material, to which adds its extreme physiochemical, mechanical, and electrical properties. The used precipitation method also confirmed the high reproducibility using BDD substrate and its high interests using simple electrolytes such as Na_2SO_4 or NaNO_3 and a low current density of few $\text{mA}\cdot\text{cm}^{-2}$ with respect to previous works.

Author Contributions: Conceptualization, Q.-T.T. and J.d.S.; Data curation, S.P.; Formal analysis, M.P.; Methodology, Q.T.-T., S.P. and M.P.; Project administration, J.d.S.; Supervision, J.d.S. and P.B.; Visualization, M.P.; Writing—original draft, Q.T.-T.; Writing—review & editing, P.B.

Funding: The authors would like to thank the French Research Agency under contract (ANR-11-SECU-008-01-ACTIFIND) as well as the Vietnam National Foundation for Science and Technology Development (NAFOSTED) under grant number 104.06-2016.42 for funding support.

Acknowledgments: The authors would like to acknowledge their German partners from the Fraunhofer Institutes ICT and IAF as well as from the Karlsruhe Institute of Technology (KIT) for fruitful discussions.

Conflicts of Interest: The authors declare no conflict of interest.

References

- Wenzl, U.; Herz, D. Alpha-spectrometry in nuclear fuel analysis. *J. Radioanal. Chem.* **1974**, *21*, 473–483. [[CrossRef](#)]
- Wellum, R.; Molinet, R. The determination of ^{232}U and ^{236}Pu in solutions of irradiated reactor fuel by alphaspectrometry. *Nucl. Instrum. Methods Phys. Res.* **1984**, *223*, 523–527. [[CrossRef](#)]

3. Bacrania, M.K.; Croce, M.P.; Bond, E.M.; Dry, D.E.; Moody, W.A.; LaMont, W.A.; Rabin, M.W.; Rim, J.H.; Smith, A.A.; Beall, J.A.; et al. Ultra-High-Resolution Alpha Spectrometry for Nuclear Forensics and Safeguards Applications. *Int. Nucl. Inf. Syst.* **2010**, *42*, 1–5.
4. Jain, H.C.; Aggarwal, S.K. *Role of Alpha Spectrometry in Nuclear Technology, in Artificial Radioactivity*; Rao, K.N., Arnikar, H.J., Eds.; Tata McGraw-Hill: New Delhi, India, 1985; p. 263.
5. Bergamini, G.; Taddei, M.H.T.; Rosa, M.M.L.; Ferreira, M.T.; Cheberle, L.T.V.; dos Santos, S.M.C.; Mariano, N.A.; Ramos, E.C.T. Determination of ^{226}Ra in drinking water samples by alpha spectrometry. *J. Radioanal. Nucl. Chem.* **2016**, *307*, 829–834. [[CrossRef](#)]
6. Bojanowski, R.; Radecki, Z.; Burns, K. Determination of radium and uranium isotopes in natural waters by sorption on hydrous manganese dioxide followed by alpha-spectrometry. *J. Radioanal. Nucl. Chem.* **2005**, *264*, 437–443.
7. Eikenberg, J.; Tricca, A.; Vezzu, G.; Bajo, S.; Ruethi, M.; Surbeck, H. Determination of ^{228}Ra , ^{226}Ra and ^{224}Ra in natural water via adsorption on MnO_2 -coated discs. *J. Environ. Radioact.* **2001**, *54*, 109–131. [[CrossRef](#)]
8. Vajda, N. Up-to-date radiochemical methods for the determination of long-lived radionuclides in the environment. *J. Anal. Sci. Technol.* **2011**, *2*, A108–A114. [[CrossRef](#)]
9. Pappalardo, L.; Pappalardo, G.; Amorini, F.; Branciforti, M.G.; Romano, F.P.; de Sanoit, J.; Rizzo, F.; Scafiri, E.; Taormina, A.; Gatto Rotondo, G. The complementary use of PIXE- α and XRD non-destructive portable systems for the quantitative analysis of painted surfaces. *X-Ray Spectrom.* **2008**, *37*, 370–375. [[CrossRef](#)]
10. Pappalardo, L.; de Sanoit, J.; Marchetta, C.; Pappalardo, G.; Romano, F.P.; Rizzo, F. A portable spectrometer for simultaneous PIXE and XRF analysis. *X-Ray Spectrom.* **2007**, *36*, 310–315. [[CrossRef](#)]
11. Manickam, E.; Sdraulig, S.; Tinker, R.A. Method design and validation for the determination of uranium levels in human urine using high resolution alpha spectrometry. *J. Environ. Radioact.* **2008**, *99*, 491–501. [[CrossRef](#)]
12. Kehagia, K.; Potiriadis, C.; Bratakos, S.; Koukoulidou, V.; Drikos, G. Determination of ^{226}Ra in urine samples by alpha spectrometry. *Radiat. Prot. Dosim.* **2007**, *127*, 293–296. [[CrossRef](#)] [[PubMed](#)]
13. Dai, X.; Kramer-Tranblay, S.; Li, C. Rapid determination of ^{226}Ra in urine samples. *Radiat. Prot. Dosim.* **2012**, *151*, 30–35. [[CrossRef](#)]
14. Salih, N.F.; Jafri, Z.M.; Aswood, M.S. Measurement of radon concentration in blood and urine samples collected from female cancer patients using RAD7. *J. Radiat. Res. Appl. Sci.* **2016**, *9*, 332–336. [[CrossRef](#)]
15. DeRegge, P.; Boden, R. Review of chemical separation techniques applicable to alpha spectrometric measurements. *Nucl. Instrum. Methods Phys. Res.* **1984**, *223*, 181–187. [[CrossRef](#)]
16. Horwitz, E.P.; Chiarizia, R.; Dietz, M.L.; Diamond, H. Separation and pre-concentration of actinides from acidic media by extraction chromatography. *Anal. Chim. Acta* **1993**, *281*, 361–372. [[CrossRef](#)]
17. Crespo, M.T. A review of electrodeposition methods for the preparation of alpha-radiation sources. *Appl. Radiat. Isot.* **2012**, *70*, 210–215. [[CrossRef](#)] [[PubMed](#)]
18. Aggarwal, S.K.; Chourasiya, G.; Duggal, R.K.; Singh, C.P.; Rawat, A.S.; Jain, H.C. A comparative study of different methods of preparation of sources for alpha spectrometry of plutonium. *Nucl. Instrum. Methods Phys. Res. Sect. A* **1985**, *238*, 463–468. [[CrossRef](#)]
19. Sibbens, G.; Altzitzoglou, T. Preparation of radioactive sources for radionuclide metrology. *Metrologia* **2007**, *44*, S71–S78. [[CrossRef](#)]
20. Garcia-Torano, E. Current status of alpha-particle spectrometry. *Appl. Radiat. Isot.* **2006**, *64*, 1273–1280. [[CrossRef](#)] [[PubMed](#)]
21. Aggarwal, S.K. Alpha-particle spectrometry for the determination of alpha emitting isotopes in nuclear, environmental and biological samples: Past, present and future. *Anal. Methods* **2016**, *8*, 5353–5371. [[CrossRef](#)]
22. Vajda, N.; Martin, P.; Kim, C.K. Alpha spectrometry. In *Handbook of Radioactivity Analysis*; L'Annunziata, M.F., Ed.; Academic Press: Cambridge, MA, USA, 2012; pp. 363–422. [[CrossRef](#)]
23. Vajda, N.; Kim, C.K. Determination of transuranium isotopes (Pu, Np, Am) by radiometric techniques: A review of analytical methodology. *Anal. Chem.* **2011**, *83*, 4688–4719. [[CrossRef](#)]
24. Vajda, N.; Kim, C.K. Determination of Pu isotopes by alpha spectrometry: A review of analytical methodology. *J. Radioanal. Nucl. Chem.* **2010**, *283*, 203–223. [[CrossRef](#)]
25. Van Ammel, R.; Eykens, S.; Eykens, R.; Pomme, S. Preparation of drop-deposited quantitative uranium sources with low self-absorption. *Nucl. Instrum. Methods Phys. Res. Sect. A* **2011**, *652*, 76–78. [[CrossRef](#)]

26. Sill, C.W.; Williams, R.L. Preparation of actinides for alpha spectrometry without electrodeposition. *Anal. Chem.* **1981**, *53*, 415–421. [[CrossRef](#)]
27. Broda, E. *Advances in Radiochemistry and in the Method of Producing Radioelements by Neutron Irradiation*; Cambridge University Press: Cambridge, UK, 1950; 152p.
28. Robbins, C.J. *Analytical Chemistry of Manhattan Project*; McGraw-Hill Book Company: New York, NY, USA, 1950; p. 449.
29. Puphal, K.W.; Olsen, D.R. Electrodeposition of alpha-emitting nuclides from a mixture oxalate-chloride electrolyte. *Anal. Chem.* **1972**, *44*, 284–289. [[CrossRef](#)]
30. Talvitie, N.A. Electrodeposition of Actinides for alpha spectrometric determination. *Anal. Chem.* **1972**, *44*, 280–283. [[CrossRef](#)]
31. Mohapatra, P.K.; Khopkar, P.K. Hydrolysis of actinides and lanthanides: Hydrolysis of some trivalent actinide and lanthanide ions studied by extraction with thenoyltrifluoroacetone. *Polyhydron* **1989**, *8*, 2071–2076. [[CrossRef](#)]
32. Neck, V.; Kim, J.I. Solubility and hydrolysis of tetravalent actinides. *Radiochim. Acta* **2001**, *89*, 1–16. [[CrossRef](#)]
33. Kressin, I.K. Electrodeposition of plutonium and Americium for high resolution alpha spectrometry. *Anal. Chem.* **1977**, *49*, 842–846. [[CrossRef](#)]
34. Hallstadius, L. A method for the electrodeposition of actinides. *Nucl. Instrum. Meth. Phys. Res. A* **1984**, *223*, 266–267. [[CrossRef](#)]
35. De Sanoit, J.; Tran, Q.T.; Pomorski, M.; Pierre, S.; Mer-calfati, C.; Bergonzo, P. Design of an electrochemically assisted radiation sensor for α -spectrometry of actinides traces in water. *Appl. Radiat. Isot.* **2013**, *80*, 32–41. [[CrossRef](#)]
36. Tran, Q.T.; Pomorski, M.; de Sanoit, J.; Scorsone, E.; Bergonzo, P. Optimization of Actinides Trace Precipitation on Diamond/Si PIN Sensor for Alpha-Spectrometry in Aqueous Solution. *Trans. Nucl. Sci.* **2014**, *61*, 2082–2089. [[CrossRef](#)]
37. De Sanoit, J.; Vanhove, E.; Mailley, P.; Bergonzo, P. Electrochemical diamond sensors for TNT detection in water. *Electrochim. Acta* **2009**, *54*, 5688–5693. [[CrossRef](#)]
38. Maybeck, V.; Edgington, R.; Bongrain, A.; Welch, J.O.; Scorsone, E.; Bergonzo, P.; Jackman, R.B.; Offenhäusser, A. Boron-Doped Nanocrystalline Diamond Microelectrode Arrays Monitor Cardiac Action Potentials. *Adv. Healthc. Mater.* **2014**, *3*, 283–289. [[CrossRef](#)]
39. Kiran, R.; Scorsone, E.; de Sanoit, J.; Arnault, J.C.; Mailley, P.; Bergonzo, P. Boron doped diamond electrodes for direct measurement in biological fluids: An in situ regeneration approach. *J. Electrochem. Soc.* **2013**, *160*. [[CrossRef](#)]
40. Scorsone, E.; Belghiti, D.; Habchi, M.; Bergonzo, P. Boron doped diamond/metal nanocatalyst hybrid electrode arrays for analytical applications. In Proceedings of the 2017 ISOCs/IEEE International Symposium on Olfaction and Electronic Nose (ISOEN), Montreal, Canada, 28–31 May 2017. [[CrossRef](#)]
41. Belghiti, D.K.; Zadeh-Habchi, M.; Scorsone, E.; Bergonzo, P. Boron Doped Diamond/Metal Nanoparticle Catalysts Hybrid Electrode Array for the Detection of Pesticides in Tap Water. *Procedia Eng.* **2016**, *168*, 428–431. [[CrossRef](#)]
42. Belghiti, D.K.; Scorsone, E.; de Sanoit, J.; Bergonzo, P. Simultaneous detection of indole and 3-methylindole using boron-doped diamond electrodes. *Phys. Stat. Solidi (A) Appl. Mater. Sci.* **2016**, *213*, 2662–2671. [[CrossRef](#)]
43. Piret, G.; Hébert, C.; Mazellier, J.-P.; Rousseau, L.; Scorsone, E.; Cottance, M.; Lissorgues, G.; Heuschkel, M.O.; Picaud, S.; Bergonzo, P.; et al. 3D-nanostructured boron-doped diamond for microelectrode array neural interfacing. *Biomaterials* **2015**, *53*, 173–183. [[CrossRef](#)]
44. Tran, Q.T.; de Sanoit, J.; Pierre, S.; Arnault, J.-C.; Bergonzo, P. Diamond electrodes for trace alpha pollutant sequestration via covalent grafting of nitrilotriacetic acid (NTA) ligand. *Electrochim. Acta* **2014**, *136*, 430–434. [[CrossRef](#)]
45. Vanhove, E.J.; Mailley, P.; Pinault, M.A.; Jomard, F.; Bergonzo, P. High Reactivity and stability of diamond electrode: The influence of the B-doping concentration. *Phys. Stat. Sol.* **2009**, *2006*, 2063–2069. [[CrossRef](#)]
46. Kiran, R.; de Sanoit, J.; Scorsone, E. (WO2012110600) Method for activating a doped diamond electrode. Patent application no: 1151341, 18 February 2011.
47. Kiran, R.; Scorsone, E.; Mailley, P.; Bergonzo, P. Quasi-real time quantification of uric acid in urine using boron doped diamond microelectrode with in situ cleaning. *Anal. Chem.* **2012**, *84*, 10207–10213. [[CrossRef](#)]

48. Tsoupko-Sitnikov, V.; Dayras, F.; de Sanoit, J.; Filosofov, D. Application of rotating disk electrode technique for the preparation of Np, Pu and Am –sources. *J. Appl. Radiat. Isot.* **2012**, *52*, 357–364. [[CrossRef](#)]
49. Bergonzo, P.; Foulon, F.; Brambilla, A.; Tromson, D.; Jany, C.; Haan, S. Corrosion hard CVD diamond alpha particle detectors for nuclear liquid source monitoring. *Diam. Relat. Mater.* **2000**, *9*, 1003–1007. [[CrossRef](#)]
50. Mer, C.; Tromson, D.; de Sanoit, J.; Pomorski, M.; Bergonzo, P. Diamond detectors for alpha monitoring in corrosive media for nuclear waste activity monitoring. In Proceedings of the 2009 1st International Conference on Advancements in Nuclear Instrumentation, Measurement Methods and their Applications, Marseille, France, 7–10 June 2009. [[CrossRef](#)]



© 2019 by the authors. Licensee MDPI, Basel, Switzerland. This article is an open access article distributed under the terms and conditions of the Creative Commons Attribution (CC BY) license (<http://creativecommons.org/licenses/by/4.0/>).