



HAL
open science

Indirect electrical-control through heating of a GeTe phase change switch and Its application to reflexion type phase shifting

Ayoub Naoui, Bruno Reig, Etienne Perret, Mohamad El-Chaar, Florence Podevin

► To cite this version:

Ayoub Naoui, Bruno Reig, Etienne Perret, Mohamad El-Chaar, Florence Podevin. Indirect electrical-control through heating of a GeTe phase change switch and Its application to reflexion type phase shifting. IMAS 2023 - International Microwave & Antennas Symposium 2023, Feb 2023, Le Caire, Egypt. pp.13-16, <10.1109/IMAS55807.2023.10066891>. <cea-04528482>

HAL Id: cea-04528482

<https://cea.hal.science/cea-04528482v1>

Submitted on 1 Apr 2024

HAL is a multi-disciplinary open access archive for the deposit and dissemination of scientific research documents, whether they are published or not. The documents may come from teaching and research institutions in France or abroad, or from public or private research centers.

L'archive ouverte pluridisciplinaire **HAL**, est destinée au dépôt et à la diffusion de documents scientifiques de niveau recherche, publiés ou non, émanant des établissements d'enseignement et de recherche français ou étrangers, des laboratoires publics ou privés.



HAL Authorization

Indirect Electrical-Control Through Heating of a GeTe Phase Change Switch and Its Application to Reflexion Type Phase Shifting

Ayoub Naoui
Grenoble INP – UGA, TIMA
CEA-Leti, Univ. Grenoble Alpes
F-38000 Grenoble, France
ayoub.naoui@univ-grenoble-alpes.fr

Bruno Reig
CEA-Leti, Univ. Grenoble Alpes
F-38000 Grenoble, France
bruno.reig@cea.fr

Etienne Perret
Grenoble INP - UGA, LCIS
F-26000 Valence, France
etienne.perret@grenoble-inp.fr

Mohamad EL-Chaar
Grenoble INP – UGA, TIMA
F-38031 Grenoble, France
mohamad.el-chaar@grenoble-inp.fr

Florence Podevin
Grenoble INP – UGA, TIMA
F-38031 Grenoble, France
florence.podevin@grenoble-inp.fr

Abstract— This paper presents a switch based on GeTe (Germanium-Telluride) phase-change material (PCM) suitable for millimeter-wave applications. A shunt configuration with indirect excitation through heating is proposed to facilitate the implementation process in integrated circuits and to reduce impact on RF signal. Electromagnetic simulations, from 50 GHz up to 70 GHz, of two parallel switches shunted a CPW transmission line (TL) show an overall ON-state resistance (R_{ON}) of 3Ω with an OFF-state capacitance (C_{OFF}) of 7.1 fF. This leads to a high Figure-of-Merit with a cutoff frequency of 7.5 THz. The demonstrated performance is validated through the design of a reflection-type phase shifter (RTPS), where a 3-dB branch-line coupler is loaded with tunable-length lines using those shunt-switches. Simulation results of the RTPS show great precision in terms of phase tunability with an insertion loss (IL) less than 2.7 dB at 60 GHz.

Keywords— RF-switches; Phase change material (PCM); GeTe; Branch-line coupler; RTPS phase shifters;

I. INTRODUCTION

PCMs have traditionally been used for memory purposes [1], and in optical storage industry [2]. More recently, chalcogenide PCMs have shown strong interest in a new type of RF switches that should become one of the key technologies for modern RF and millimeter-wave applications, as they can solve the current problems related to millimeter-wave radars and 6G beam-steering (switches loss, addition of higher and higher frequency bands, ...), and to the rapid development of technologies for communication (device size reduction, manufacturing costs, power consumption, ...) [3]. This type of PCM-based RF switches, as GeTe or GST, exhibits remarkable RF performance in terms of low insertion loss in the ON-state [4], high isolation in the OFF-state over wide frequency ranges, low power consumption, and higher figure of merit than current semiconductor-based switching technologies. Also, these devices have the unique characteristic of no primary steady-state power consumption, making them non-volatile switches. This makes them

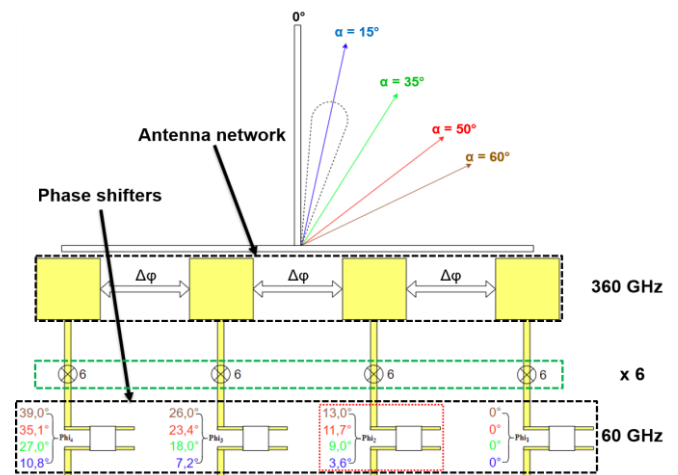

Fig. 1: 4-antenna array with dedicated phase-shifts to reach azimuth angle positions α up to 60° .

remarkable candidates for adaptive, reconfigurable circuits (filter, antenna, phase shifters, etc), operating at frequencies above 50 GHz.

Most reconfigurable RF circuits consist of the integration of localized tunable devices into a well-established RF circuit and are usually based on semiconductor devices, like PIN diodes, or RF-MEMS devices, and ferroelectric varactors [5]-[6]-[7]-[8].

In this paper, we present the integration of PCM switches (GeTe) in a 360 GHz reconfigurable antenna feed system with a tunable radiation pattern (control of the azimuth angle α). Phase-shifts at 360 GHz will be the multiplied version by 6 (Frequency up-converter)(green dashed box in Fig. 1) of phase-shifts at 60 GHz, meaning very small phase shifts difference at 60 GHz from one position to another while keeping similar losses whatever the phase shift (Fig. 1). In order to satisfy those constraints, a RTPS with loaded transmission lines used in reflective mode is a good solution.

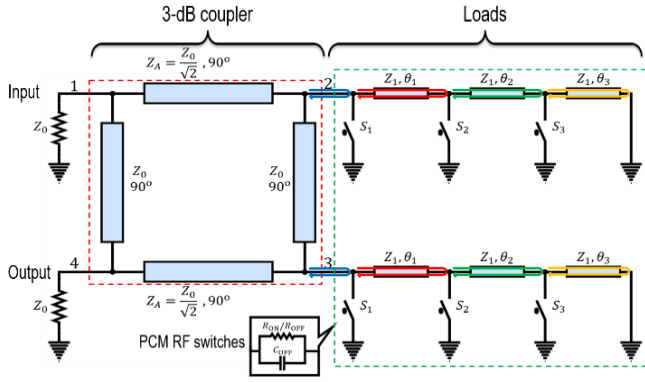

Fig. 2: Schematic of the RTPS loaded with tunable-length TL used in a reflective mode with PCM RF switches (S1,S2,S3) in shunt configuration.

As presented schematically in Fig. 2, the idea is to integrate low loss PCM switches in shunt configuration along transmission lines in order to achieve a certain phase shift equivalent to the return delay along the short-circuited transmission line segments.

This article is organized as follow. The performance of GeTe switches with indirect electrical excitation and the optimization of their dimensions are described in Section II. In section III, the methodology to design a mm-wave RTPS is explained. Some EM simulation are performed for the different blocks of the RTPS, as well as for the complete circuit showing good results. Finally, some perspectives are provided for possible improvements in terms of performance.

II. PHASE CHANGE SWITCHES PERFORMANCE

The RF-PCM switch shown in Fig. 3 takes advantage of the GeTe material for switching between the ON and OFF states. Reversible switching is achieved in PCM materials by applying an electrical pulse signal. A short pulse (~ 400 ns) via the integrated heater is used to heat the GeTe above its melting temperature (T_m) and quenching changes the crystalline orientation of the material, which solidifies the atoms and switches the PCM to the amorphous (OFF) state. Crystallization is achieved by applying a pulse to the heater with about $1\mu s$ of duration that heats the GeTe material above its recrystallization temperature (T_c), at which crystal grains growth and nucleation are activated, changing the resistivity of the PCM from the amorphous (high resistivity) to the crystalline state (low resistivity).

A. Design Process

For the design process, our circuit was implemented on ANSYS HFSS software for its 3D EM simulation capability. The shunt configuration is chosen for the PCM switches because of the lower influence of the DC excitation lines on the RF signal (no coupling from ground to signal paths through perpendicular DC feeds). In addition, insertion losses are reduced by a factor of two, since the switch resistance in the ON-state in this configuration is divided by two.

Fig. 3 shows a 3D view of our designed CPW line with PCM switches where the GeTe is excited indirectly via a heater placed above it. This excitation technique occurs through current induction into the heater where the latter

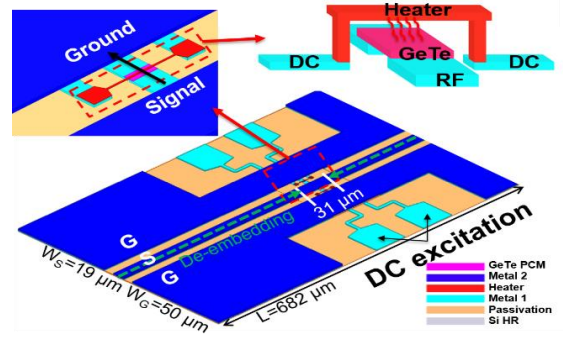

Fig. 3: 3D design of CPW line with two PCMs in shunt configuration. The GeTe width is $7\mu m$, the GeTe length is 500 nm and the GeTe thickness is 100 nm. The GeTe is excited indirectly via a 500 nm – wide tungsten heater separated from the GeTe by a 100 nm-thick AlN dielectric layer.

transforms it into thermal energy transferred to the GeTe. This changes the GeTe-material phase. Contrarily to the direct excitation where current pass to GeTe via the RF lines [9], it allows to separate the RF- and DC- lines which decreases the impact on the RF signal.

B. Simulation Results

In order to analyze the switches impact on the CPW line frequency-behavior, as a first step, the TL extensions from both ports are de-embedded while leaving just $31\mu m$ in front of switches to take into account the DC-lines and heater presence (see Fig. 3). Then, as a second step, simulation was performed without and with PCM switches (in amorphous state).

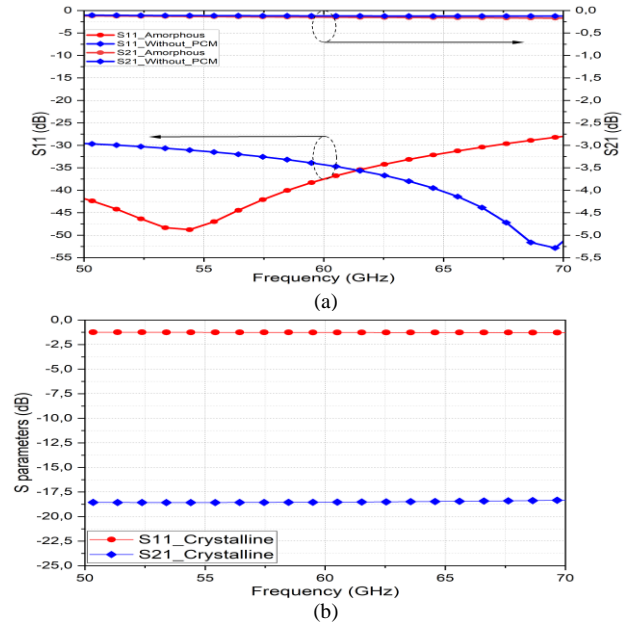

Fig. 4: Simulation results of the switch characterized in shunt configuration. (a) Amorphous state. (b) Crystalline state.

TABLE 1: SIMULATION RESULTS OF THE SWITCH CHARACTERIZED IN SHUNT CONFIGURATION AT 60 GHz

At 60 GHz		S11 (dB)	S21 (dB)
Amorphous state	With PCM	-37.25	-0.15
	Without PCM	-38.1	-0.14
Crystalline state		-1.27	-18.55

A comparison of S-parameter results between 50 GHz and 70 GHz is illustrated in Fig. 4(a), and Table 1 highlights results at 60 GHz. Noticeable impact was only observed on the ports reflection coefficient, where a shift towards low frequencies occurred. This is attributed to the switches OFF-state capacitance (C_{OFF}). From Table 1, at 60 GHz, a difference of only 0.01 dB in S21 is obtained with a S11 better than -30 dB. This supports the high quality of these switches in mm-wave frequencies, while comparing these results with those obtained [10], [11].

Fig. 4(b) illustrates the simulation results of the CPW line with the switches in the crystalline state between 50 GHz and 70 GHz. Isolation of 18.54 dB with reflection coefficient of 1.26 dB are observed at 60 GHz (Table 1), which signifies a good ground connection provided by the low resistance of the GeTe PCM-switch (material resistivity equals to $5.41 \cdot 10^{-6} \Omega$).

III. PROPOSED RTPS DESIGN

In this section, the GeTe PCM-switches are used in the design of a 60-GHz RTPS. The choice towards such RTPS topology is attributed to the good compromise it offers between input/output port matching and compactness.

Referring to Fig. 2, this is done by loading a 3-dB branch-line coupler with two tunable-length TLs where both are realized by implementing shunt switches between several segments. Its basic principle-of-operation is to tune the output phase (port 4) through adjusting the length of the TL loads by controlling the PCM switches.

A. 3-dB Branch-line coupler

By investigating first the 3-dB coupler by itself and by referring to Fig. 2 annotations, the RF-signal enters through port 1 (upper left side) and then it is divided into two signals on the output ports 2 and 3 (right side) with equal magnitude but with 90° phase difference between them. The remaining port 4 (lower left side) is commonly referred to as an isolated port, since the signal entering port 1 does not leak through it at the center frequency of operation.

The 3-dB coupler design was provided and optimized on HFSS, while respecting the technology design rules, given by CEA-Léti. Table 2 summarizes the performance at the operating frequency of interest (60 GHz). Almost -20 dB of matching is obtained at port 1, signifying good matching. An overall insertion loss of 4.67 dB and 4.42 dB is obtained on the direct port (S21) and coupled port (S31), respectively. This total attenuation is a combination of the coupler 3-dB division in addition to the losses coming from the lines and the narrow Y-junction transition connecting them (see Fig. 5). A phase difference, of 90.91° is obtained between ports 2 and 3.

B. Reflection-type phase shifter (RTPS)

1) Targeted phase-shifts

The reflection network added on the 3-dB coupler (highlighted using green dashed box in Fig. 2) is composed of TL with different electrical lengths (θ_1 , θ_2 and θ_3), separated by three identical PCM switches (S_1 , S_2 and S_3), in shunt configuration to carry out small values of angles, particularly constraining (see the values of expected phases highlighted

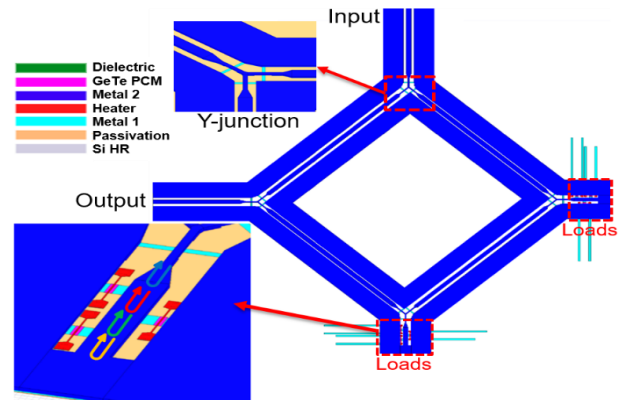

Fig. 5: Design of RTPS with CPW lines and RF-PCM switches.

using red dashed box in Fig. 1).

2) Design

The RTPS structure and 3D view of the loaded line is shown in Fig. 5. Dimensioning and design of the switch in shunt configuration, as well as the DC lines to feed the heater with DC current have been a part of this work. Optimization was performed so that the DC lines do not affect the RF signal. The PCM switch dimensions have been chosen so that the additional phase delay induced by its presence was considered in the TL segments design.

First, the switches are turned off over the short-circuited line with a defined length L , to determine the phase reference brought back by this length and the capacitors. The position of each switch is calculated with (1) to obtain the phase differences targeted in Fig. 1.

$$\theta = \beta \cdot L \quad (1)$$

Where β is the propagation constant of the TL.

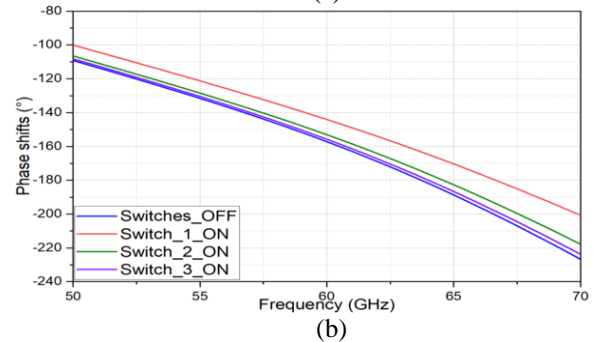
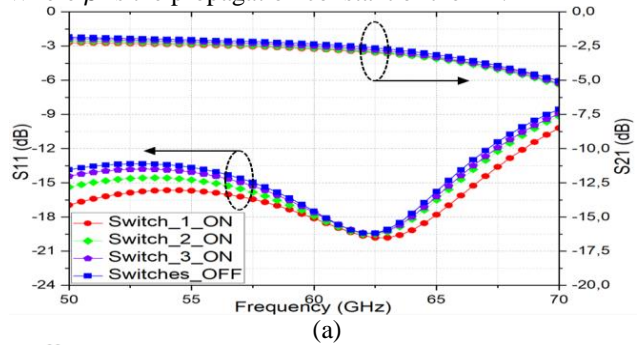

Fig. 6: Simulated results of RTPS depending on the switches state : (a) magnitude of S-parameters, (b) phase of the transmission coefficient S21.

TABLE 2: SIMULATION RESULTS OF BRANCH-LINE COUPLER @ 60 GHZ

S11 (dB)	S21 (dB)	S31 (dB)	S41 (dB)	S32 (°)
-19.51	-4.67	-4.42	-22.94	90.91

TABLE 3: SIMULATIONS RESULTS WITH DIFFERENT STATES OF THE SWITCHES @ 60 GHZ.

Switch_1	Switch_2	Switch_3	S41 (dB)	S11 (dB)	S41 (°)	S41_T(°)
ON	OFF	OFF	-2.72	-18.13	2.1	3.6
OFF	ON	OFF	-2.63	-17.91	8.1	9
OFF	OFF	ON	-2.5	-17.61	11	11.7
OFF	OFF	OFF	-2.34	-17.49	13	13

1) Simulations and Results

Fig. 6(a) illustrates the simulated S-parameter results versus frequency between 50 GHz and 70 GHz and Fig. 6(b) shows the simulated phase difference between the input (port 1) and output (port 4). Table 3 summarizes the performance at the operating frequency of interest (60 GHz). Almost -18 dB of matching is obtained at port 1, signifying good matching at the operating frequency. A total of 2.6 dB of insertion losses is obtained on the circuit (3-dB coupler + loads). The phase difference is obtained as a function of the actuated switch and we can see, that the phase shifts resulted from the simulation (the sixth column), are very close to the expected phase shifts (the seventh column).

IV. CONCLUSION

Through this work, the interest of the GeTe PCM-switch as a standalone device suitable for mm-wave applications was demonstrated. CEA-Léti technology was used to implement the design of a RTPS integrated circuit at 60 GHz, with the use of PCM RF switches (more precisely GeTe) in a shunt configuration to tune the line length.

ACKNOWLEDGMENT

This work was financially supported by the Presidency of Grenoble Institute of Technology of the University Grenoble Alps and the French Public Authorities within the frame of IPCEI/Nano2022 project.

REFERENCES

- [1] A. Fantini *et al.*, “Comparative Assessment of GST and GeTe Materials for Application to Embedded Phase-Change Memory Devices,” in *2009 IEEE International Memory Workshop*, May 2009, pp. 1–2. doi: 10.1109/IMW.2009.5090585.
- [2] S. R. Ovshinsky, “Reversible Electrical Switching Phenomena in Disordered Structures,” *Phys. Rev. Lett.*, vol. 21, no. 20, pp. 1450–1453, Nov. 1968, doi: 10.1103/PhysRevLett.21.1450.
- [3] A. Mennai, A. Bessaudou, F. Cosset, C. Guines, P. Blondy, and A. Crunteanu, “Bistable RF switches using Ge₂Sb₂Te₅ phase change material,” in *2015 European Microwave Conference (EuMC)*, Sep. 2015, pp. 945–947. doi: 10.1109/EuMC.2015.7345920.
- [4] T. Singh and R. R. Mansour, “Monolithic PCM Based Miniaturized T-type RF Switch for Millimeter Wave Redundancy Switch Matrix Applications,” in *2019 IEEE MTT-S International Microwave Symposium (IMS)*, Jun. 2019, pp. 658–660. doi: 10.1109/MWSYM.2019.8700946.
- [5] V. Allea *et al.*, “High Power Microstrip GaN-HEMT Switches for Microwave Applications,” in *2008 European Microwave Integrated Circuit Conference*, Oct. 2008, pp. 194–197. doi: 10.1109/EMICC.2008.4772262.
- [6] W. A. Awan, A. Zaidi, N. Hussain, S. Khalid, Halima, and A. Baghdad, “Frequency Reconfigurable patch antenna for millimeter wave applications,” in *2019 2nd International Conference on Computing, Mathematics and Engineering Technologies (iCoMET)*, Jan. 2019, pp. 1–5. doi: 10.1109/ICOMET.2019.8673417.
- [7] S. Pi, M. Ghadiri-Sadrabadi, J. C. Bardin, and Q. Xia, “Memristors as radiofrequency switches,” in *2016 IEEE International Symposium on Circuits and Systems (ISCAS)*, May 2016, pp. 377–380. doi: 10.1109/ISCAS.2016.7527249.
- [8] A. Ghalem *et al.*, “Electrical transport properties and modelling of electrostrictive resonance phenomena in Ba₂/3Sr₁/3TiO₃ thin films,” *Journal of Applied Physics*, vol. 120, no. 18, p. 184101, Nov. 2016, doi: 10.1063/1.4966942.
- [9] A. Léon *et al.*, “In-depth characterisation of the structural phase change of Germanium Telluride for RF switches,” in *2017 IEEE MTT-S International Microwave Workshop Series on Advanced Materials and Processes for RF and THz Applications (IMWS-AMP)*, Sep. 2017, pp. 1–3. doi: 10.1109/IMWS-AMP.2017.8247378.
- [10] J. Moon, H. Seo, and D. Le, “Development toward high-power sub-1-ohm DC-67 GHz RF switches using phase change materials for reconfigurable RF front-end,” in *2014 IEEE MTT-S International Microwave Symposium (IMS2014)*, Jun. 2014, pp. 1–3. doi: 10.1109/MWSYM.2014.6848334.
- [11] J.-S. Moon *et al.*, “10.6 THz figure-of-merit phase-change RF switches with embedded micro-heater,” in *2015 IEEE 15th Topical Meeting on Silicon Monolithic Integrated Circuits in RF Systems*, Jan. 2015, pp. 73–75. doi: 10.1109/SIRF.2015.7119879.