



HAL
open science

Generative model approach on TFM data based on variational inference for multi-fidelity data generation

Gerardo Granados, Giorgia Colombera, Filippo Gatti, Roberto Miorelli,
Didier Clouteau, Sébastien Robert

► To cite this version:

Gerardo Granados, Giorgia Colombera, Filippo Gatti, Roberto Miorelli, Didier Clouteau, et al.. Generative model approach on TFM data based on variational inference for multi-fidelity data generation. IUTAM Symposium, Oct 2022, Paris, France. 2022. cea-04410159

HAL Id: cea-04410159

<https://cea.hal.science/cea-04410159>

Submitted on 22 Jan 2024

HAL is a multi-disciplinary open access archive for the deposit and dissemination of scientific research documents, whether they are published or not. The documents may come from teaching and research institutions in France or abroad, or from public or private research centers.

L'archive ouverte pluridisciplinaire **HAL**, est destinée au dépôt et à la diffusion de documents scientifiques de niveau recherche, publiés ou non, émanant des établissements d'enseignement et de recherche français ou étrangers, des laboratoires publics ou privés.



Generative model approach on TFM data based on variational inference for multi-fidelity data generation

Granados, Gerardo E.¹ - Colombera, Giorgia² - Gatti, Filippo² - Robert, Sébastien¹ - Miorelli, Roberto¹ - Clouteau, Didier²

¹ Université Paris-Saclay, CEA, List, F-91120, Palaiseau, France

² LMPS - Laboratoire de Mécanique Paris-Saclay CNRS



IUTAM DDMech 2022 - Paris

Generative model approach on TFM

1. Introduction

- Industrial context, motivation et applications
- Challenges for UT inspection
- Case of study: TFM data-set

2. Method

- Conditional U-Net as generator architecture

3. Results

- Metrics on test set
- Latent space (looking inside the network)

4. Conclusions and perspectives



Examples of applications in industrial fields

- Nuclear
 - Inspection of welds
 - Characterization of materials
- Metallurgy
 - Inspection of parts during manufacturing process
 - Characterization of materials
- Aeronautics and aerospace
 - Multi-layer structure
 - Composite materials



NDT&E and SHM modelling

- Data generation for diagnostic, life time prediction
- Materials characterization (Advanced Manufacturing)
- Performance demonstration
- Probe optimization
- Defect detection, classification and characterization

Exploitation of fast and reliable models

- Dimensioning and defect characterization (form/type/criticality)
- Confidence intervals on estimation (e.g., uncertainties).
- Assessment of the “well-posed” nature of the inverse problem
- Rapid Inversion (Online diagnostic)



On the application of ML to nondestructive testing and evaluation (NDT&E) and in particular in ultrasound testing (UT)

Peculiarity, challenges, and issues of UT inspection problems:

- **Access to reliable simulations** (semi-analytical approaches finite elements models, etc.)
 - ☞ model driven ML approaches are feasible
- **Lack of public realistic datasets** (security and secrecy constraint issues)
 - ☞ data driven ML approaches are very often not feasible
- Operational conditions **may impact** the measurements (from the ML perspective)
 - ☞ non-negligible impact on the acquisitions
- **Lack of knowledge** associated to the inspection scenarios
 - ☞ non-negligible aleatoric uncertainty in the data

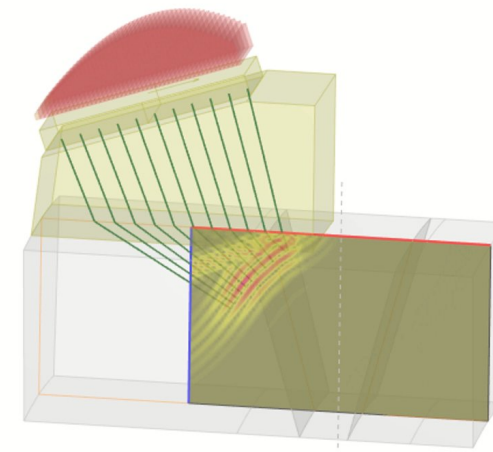

Objective: Coupling of reliable simulations and experimental data for enhancing ML performance in view of developing UT inspection and diagnostic tools

Investigated solution: Multi-fidelity deep generative model aiming at combining low fidelity (LF) simulated data and high fidelity (HF) experimental acquisitions for enhancing the performance of automatic diagnosis tools in NDT&E

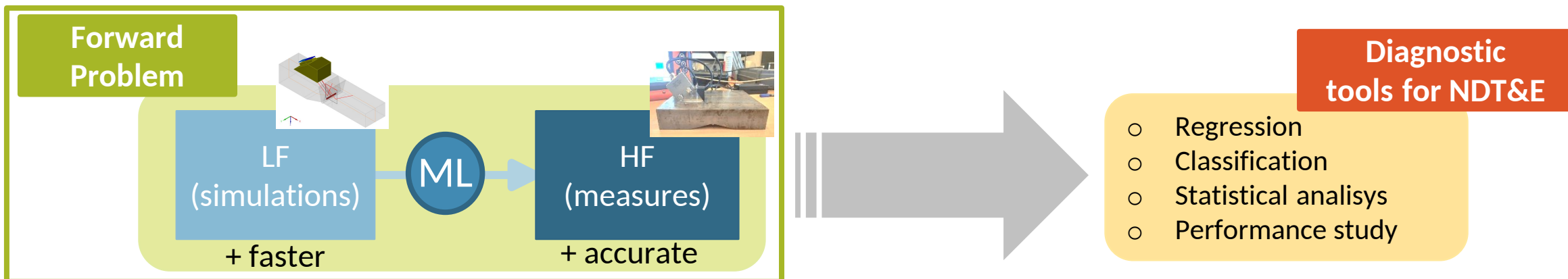

Industrial context: inspection of complex welded structures via ultrasonic testing (Total Focusing Method -TFM-) imaging



Simulation data

1. Wave emission and propagation (inspected area)
2. Interaction (diffusion) with acoustic discontinuities.
3. Simplified approach for attenuation and structural noise.

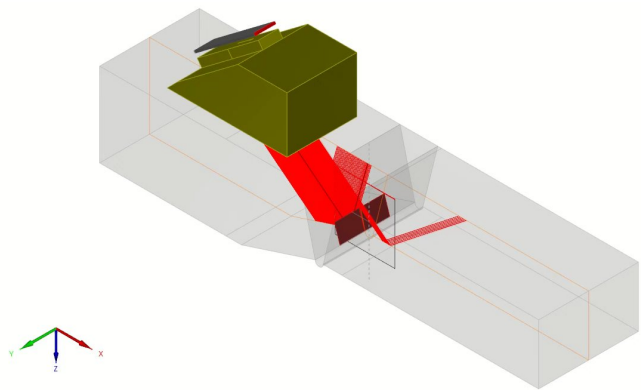
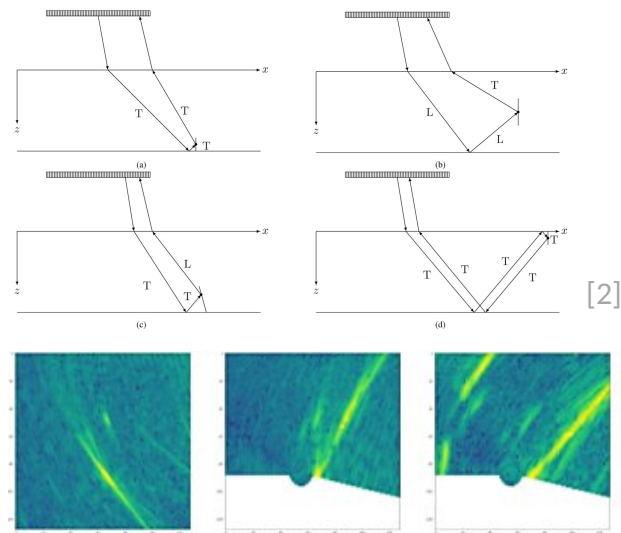
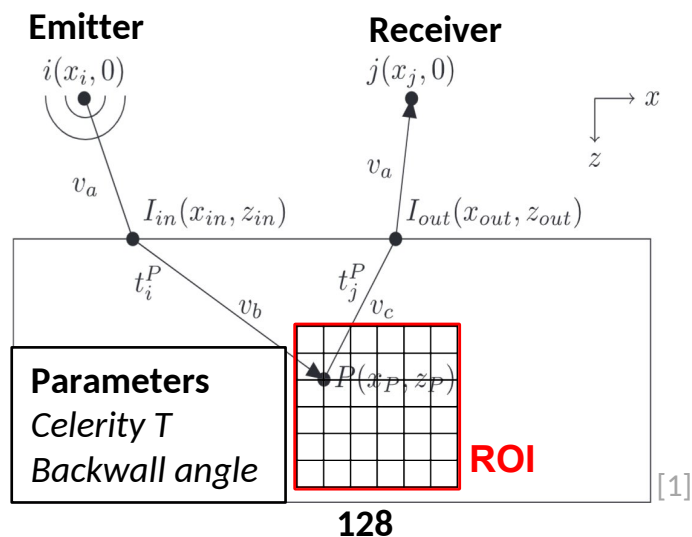

Fig 1 - CIVA configuration for simulated welded structure NDT inspection.

Some background on the generation of TFM dataset images



Experimental acquisitions



Pixel amplitude

$$s_{ij} = k_{ij}(t) + jH(k_{ij}(t))$$

$$A(P) = \left| \sum_{i=1}^N \sum_{j=1}^N s_{ij}(t_i^P + t_j^P) \right|$$

[1] L. Le Jeune, S. Robert, E.L. Lopez Villaverde, C. Prada, (2016)
 [2] L. Merabet, S. Robert, C. Prada (2020)

Multi-fidelity deep generative model: mixing mode- & data- driven approaches

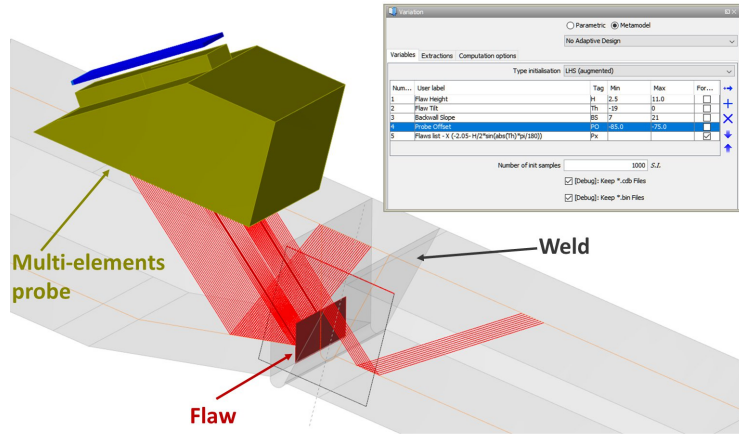

Parameters (labels)	Valeurs
Flaw orientation	Vertical ; Tilted
Flaw high	3mm ; 10mm
Wave speed T (reconstruction image)	[3080; 3380]
Alpha (angle) (reconstruction image)	[10;18]

Uncertain parameters

Example of same realisation: **simulation** and **experience** TFM reconstruction parameters without uncertainties

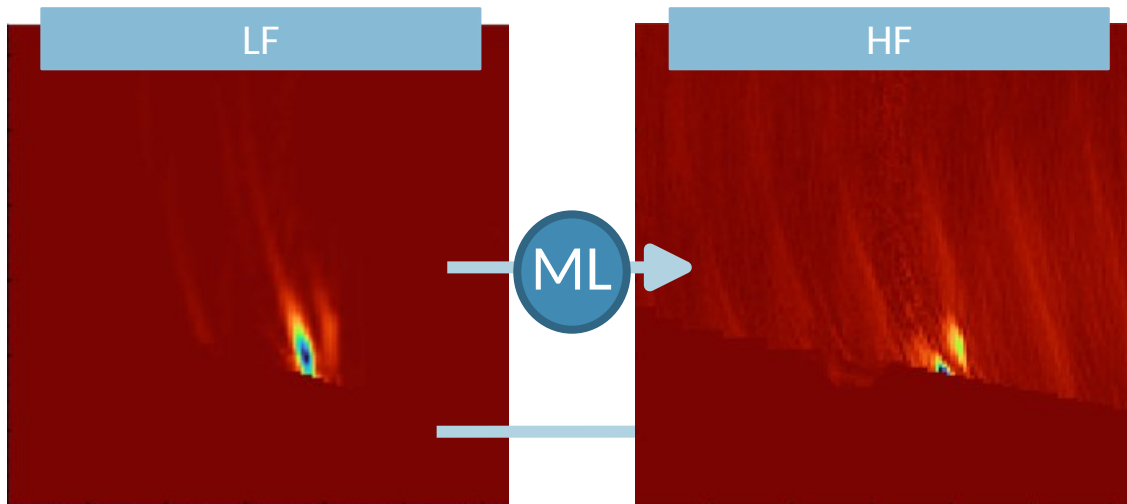

Same experimental realisation with **uncertainties on wave speed** of the piece (same flaw geometry, etc.)

Example of the impact of uncertainties on the TFM images

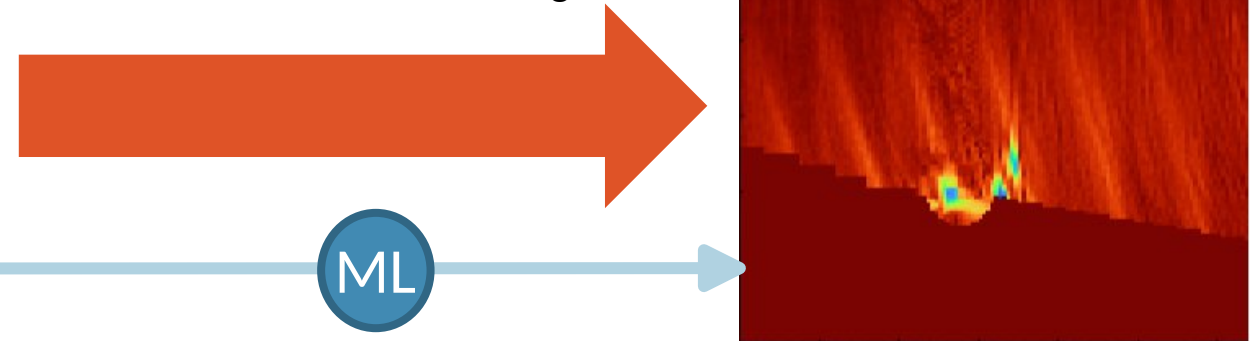

Meta Model (ML)

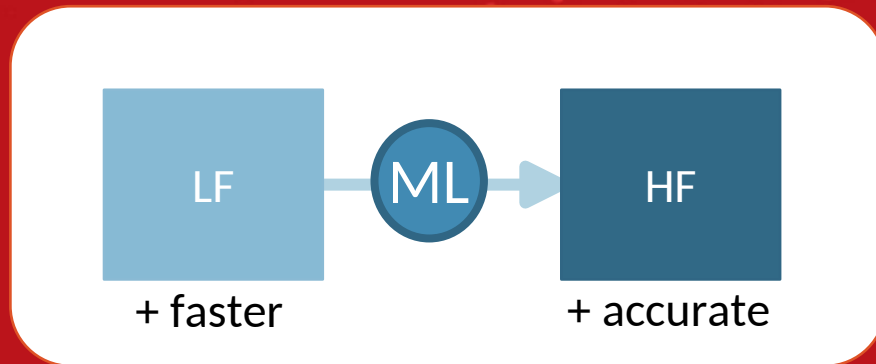

Sim. (LF) vs Exp. (HF)

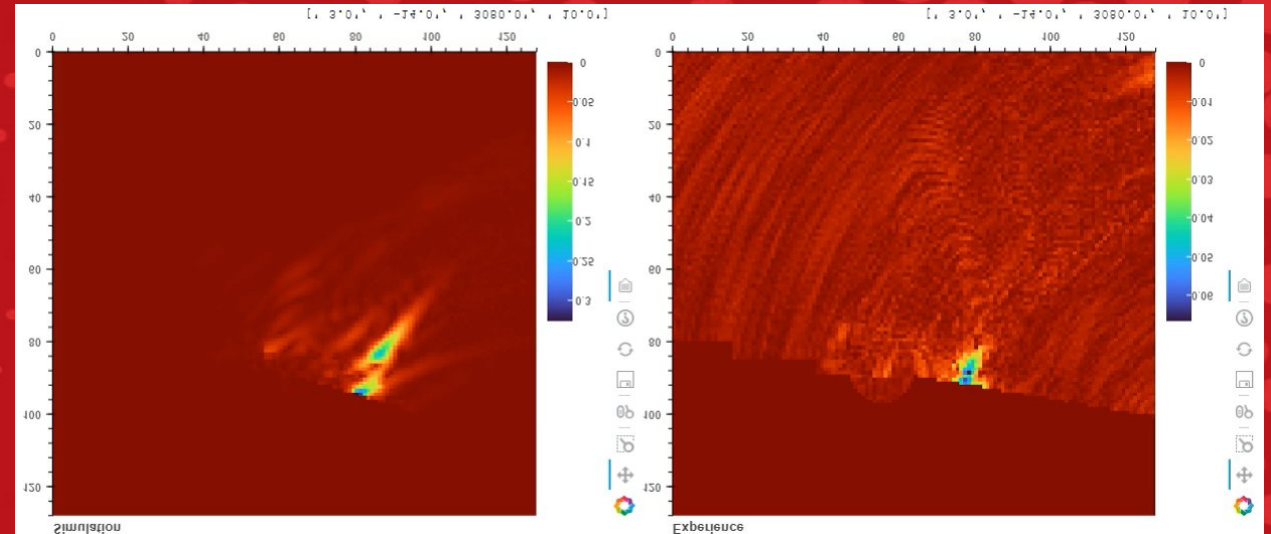

TFM samples: ~3k per class (2 classes)







Approch:

Conditional U-net on ultrasonic testing (UT) TFM images

Conditional U-Net as generator on TFM data

Architecture

U-Net common applications

-  Image classification (class distinction)
-  Objects detection (label and localization)
-  Semantic segmentation (label for each pixel)
-  Style transfer
-  Image super-resolution
-  Conditional U-Net for multitask (multi-label and multi-class)

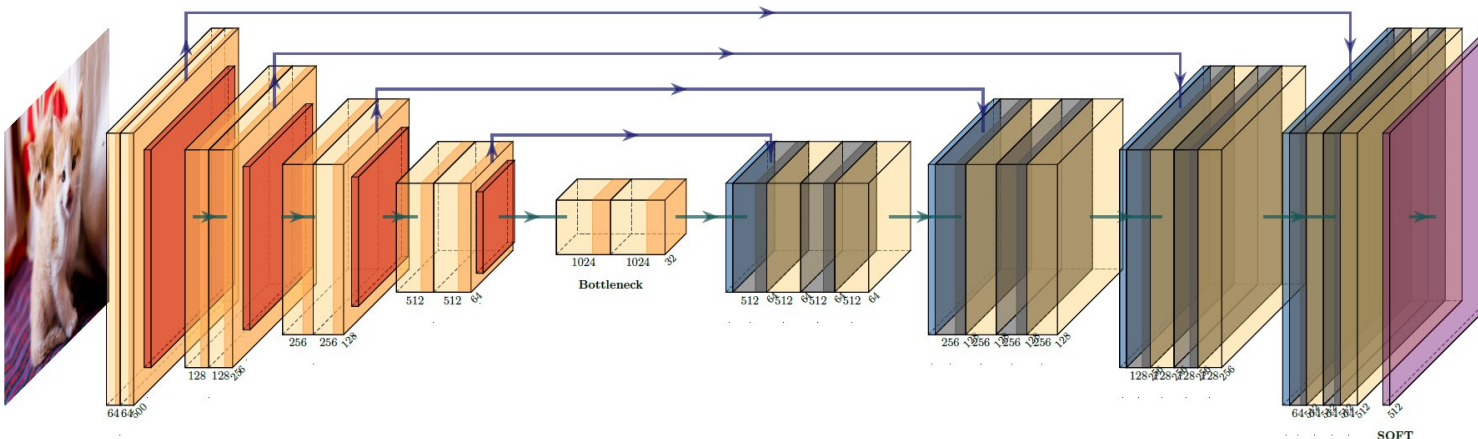

U-Net base architecture ^[3]

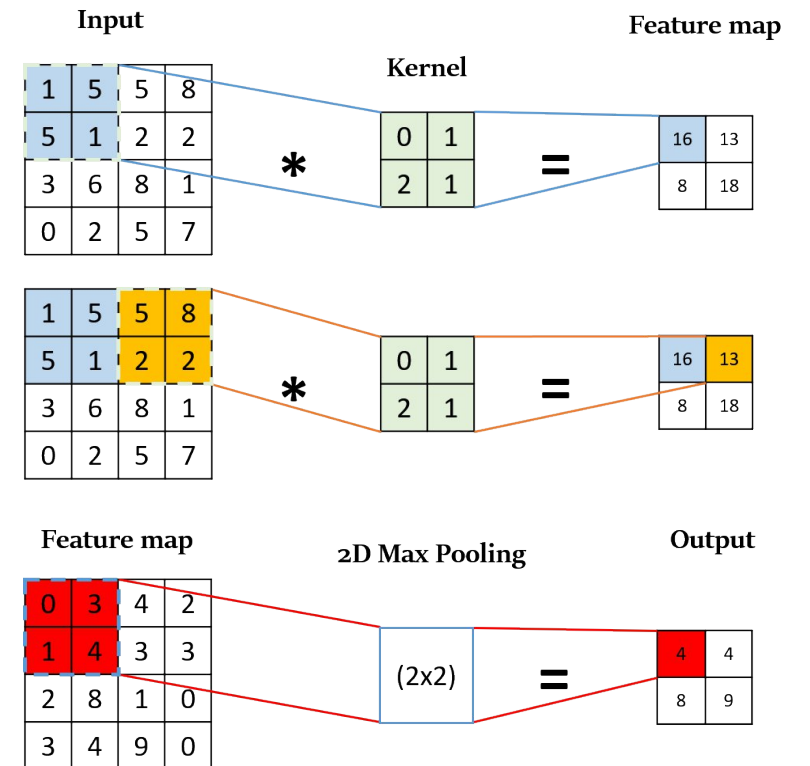

[3] Ronneberger, O., Fischer, P., Brox, T. (2015).

Convolution and 2D Max Pooling



-  Spatial features extraction
-  Learns hierarchy on images
-  Less parameters than FC layers

Conditional U-Net as generator on TFM data (supervised) Architecture: encoder - latent space - decoder - synthesis

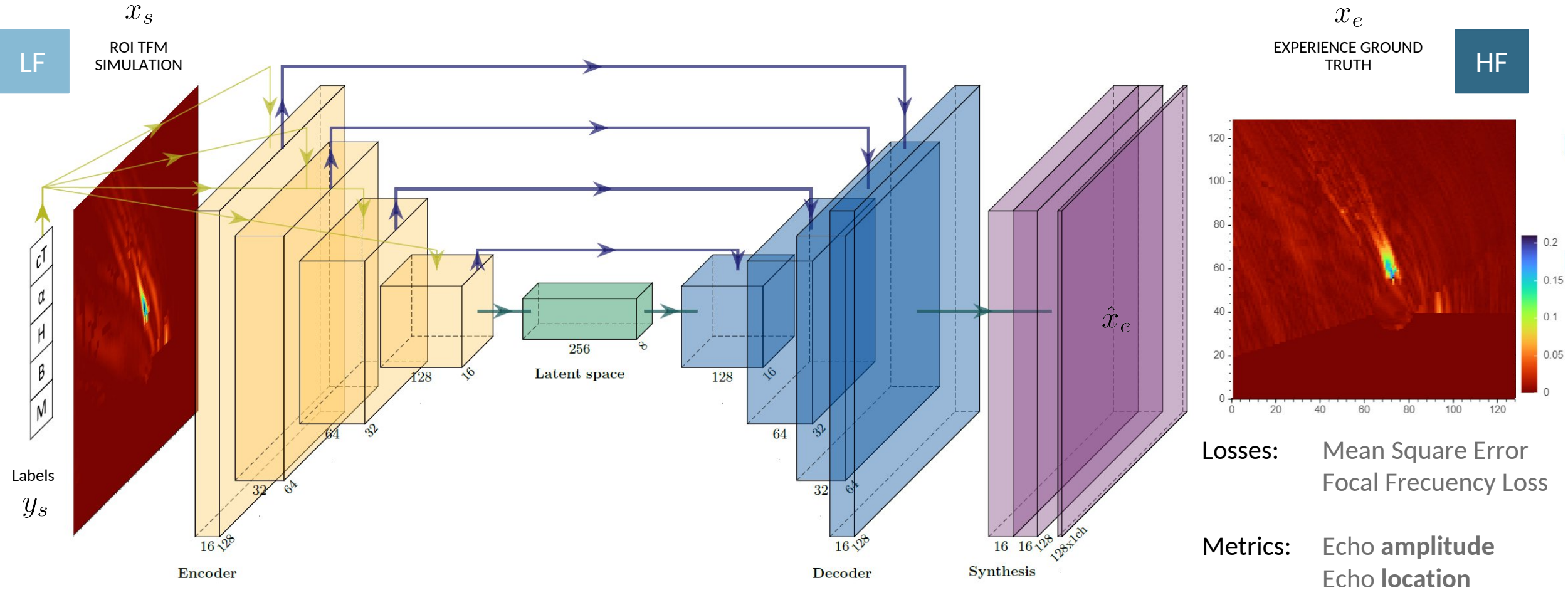
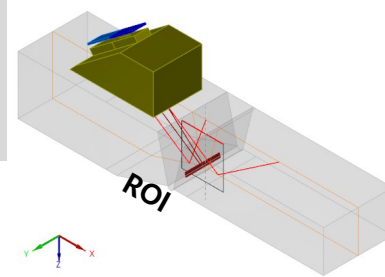
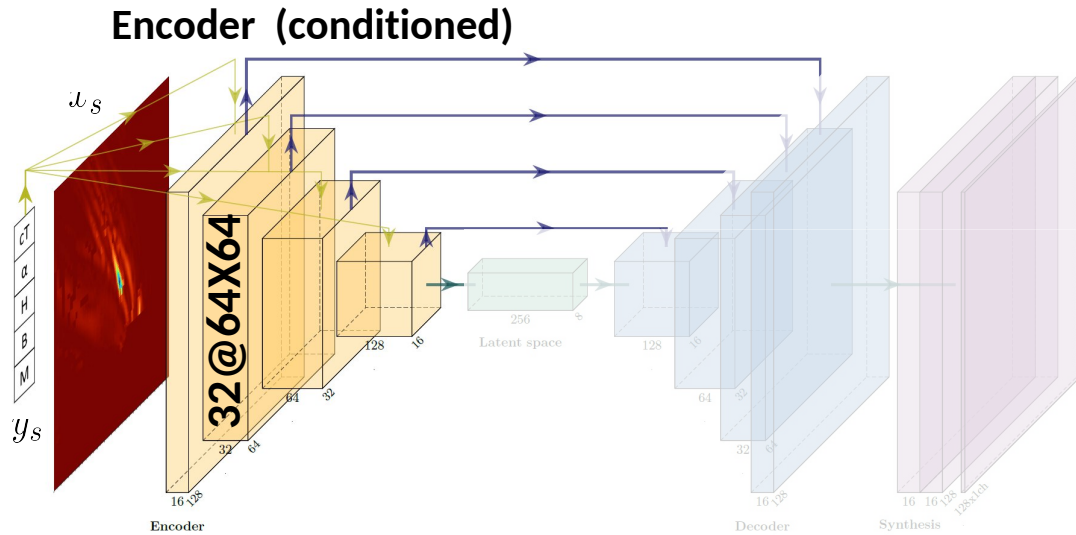

Fig 6 - Conditional CNN U-net architecture for realistic image generation.



conditioning conditioning

$$FiLM(x_k) = \gamma_k(y_s) \cdot \frac{x_k - E[x_k]}{\sqrt{Var[x_k] + \epsilon}} + \beta_k(y_s) \quad \beta_k \in \mathbb{R}^{n_{ch_k}}$$

$$\quad \quad \quad \gamma_k \in \mathbb{R}^{n_{ch_k}} \quad [4]$$

FiLM complex layer (Co):
independent affine transformations are applied to each feature map c .

The new per-channel statistics modify the relative importance of features for the subsequent convolution operation.

conditioning

$$ST(x_k) = T_\theta(y_s) \cdot x_k \quad T_\theta \in \mathbb{R}^{3 \times 3}$$

$$\theta \in \mathbb{R}^6$$

$$T_\theta = \begin{bmatrix} s & 0 & t_x \\ 0 & s & t_y \\ 1 & 1 & 1 \end{bmatrix}$$

[5]

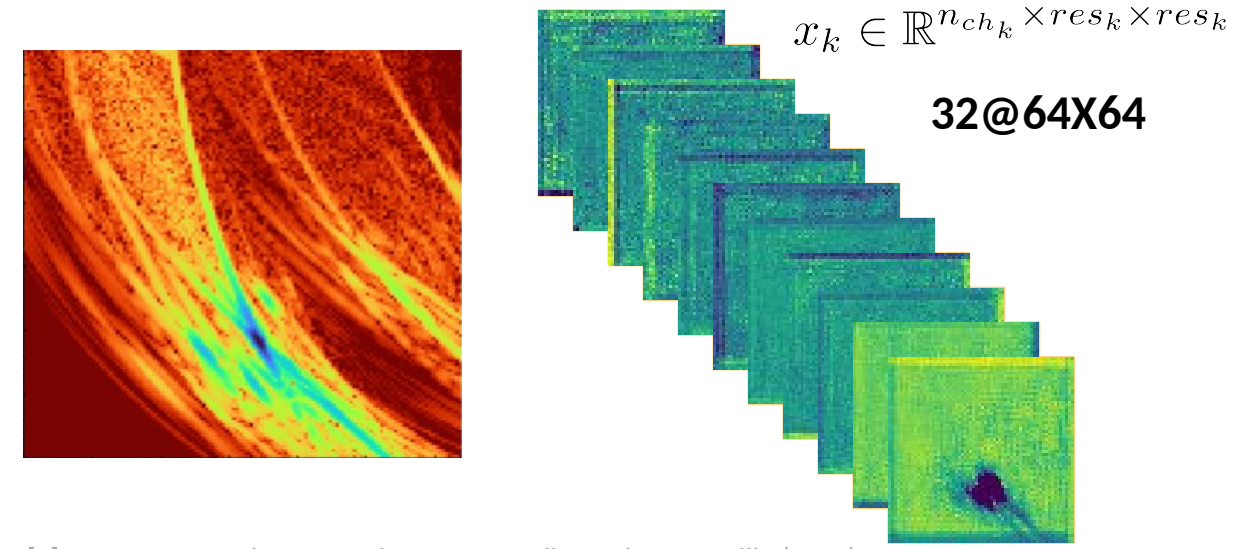

[5] M. Jaderberg, K. Simonyan, A. Zisserman, and K. Kavukcuoglu (2015).

[4] E. Perez, F. Strub, H. De Vries, V. Dumoulin, and A. Courville (2022)

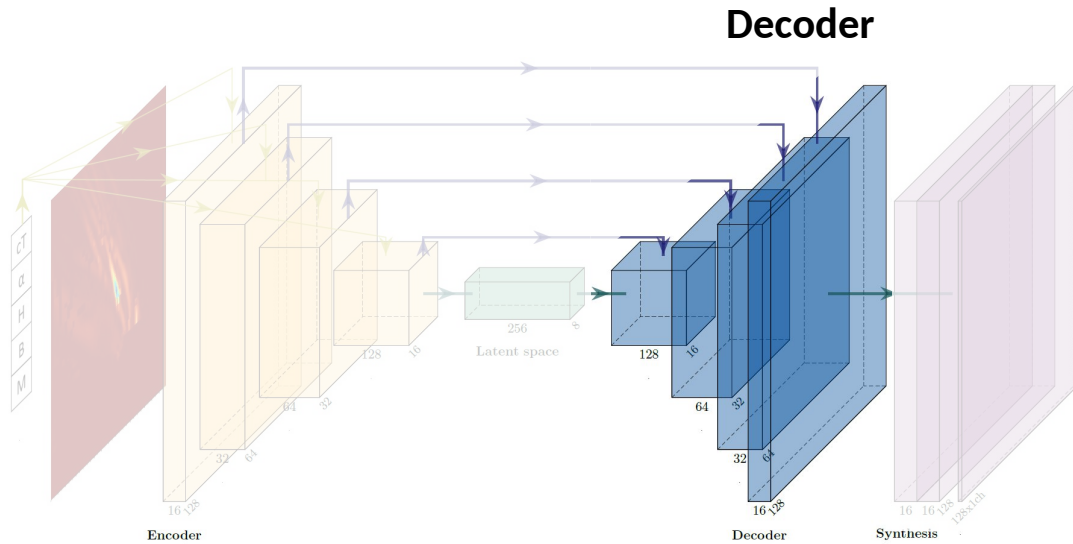

Principal layers:

- 🏠 Convolutional Neural Network
- 🏠 Fast stylization through Instance Normalisation

Task:

- 🏠 Learns the difference between classes (mse+ffl loss)
- 🏠 Take into account uncertainties from experience
- 🏠 Generate new experience data (new instances) in a supervised way

Instance Normalisation

$$IN(x_k) = \frac{x_k - E[x_k]}{\sqrt{Var[x_k] + \epsilon}} \times \gamma_k + \beta_k$$

$$\beta_k \in \mathbb{R}^{n_{ch_k}}$$

$$\gamma_k \in \mathbb{R}^{n_{ch_k}}$$

Learned bias
and scale

[6] D. Ulyanov, A. Vedaldi, and V. Lempitsky, "Instance Normalization: The Missing Ingredient for Fast Stylization," Jul. 2016, doi: 10.48550/arxiv.1607.08022.

Conditional U-Net as generator on TFM data

**Results on
Realistic data-set generation
Surrogate model**

Realistic data-set generation

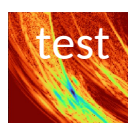
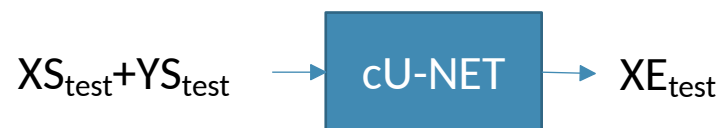

cT
α
H
B
M

Simulations from CIVA

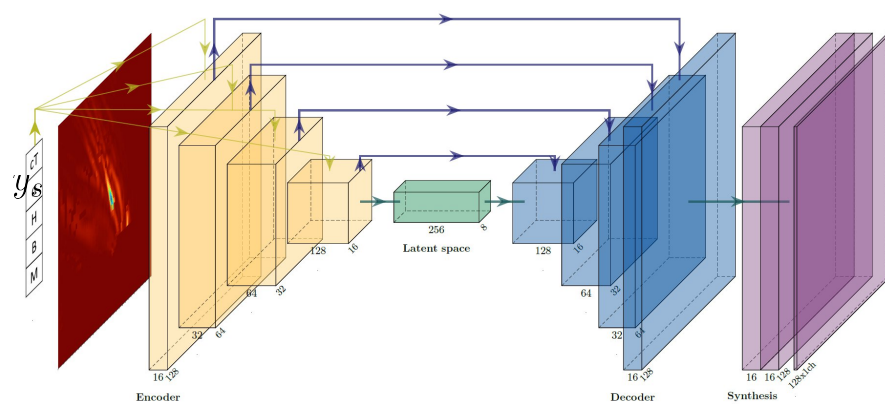

- Generate experience images
- Need new simulations

Surrogate model

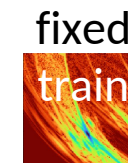
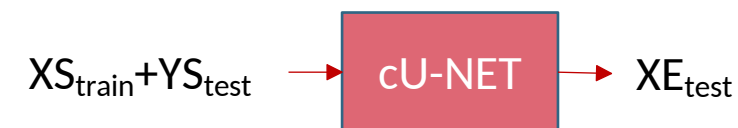

cT
α
H
B
M

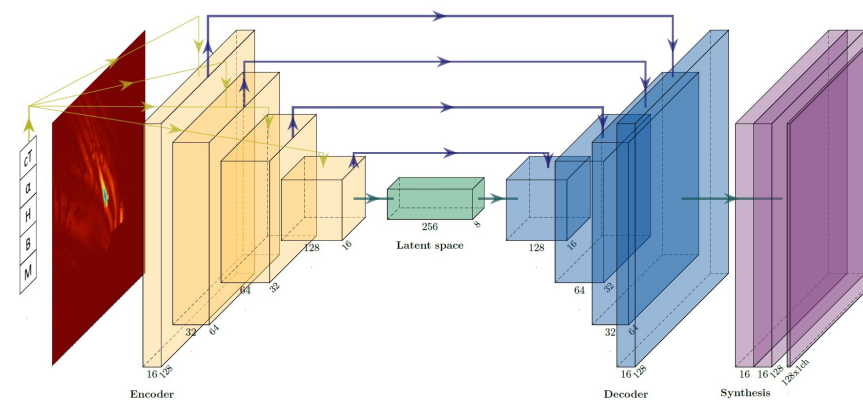
 regression

- Metamodelling just changing parameters
- No new simulation needed

U-Net Generation

- Generative frame on imaging
- Transfer experience to simulation
- Account uncertainties from experience
- Generate new data to train diagnostic tools

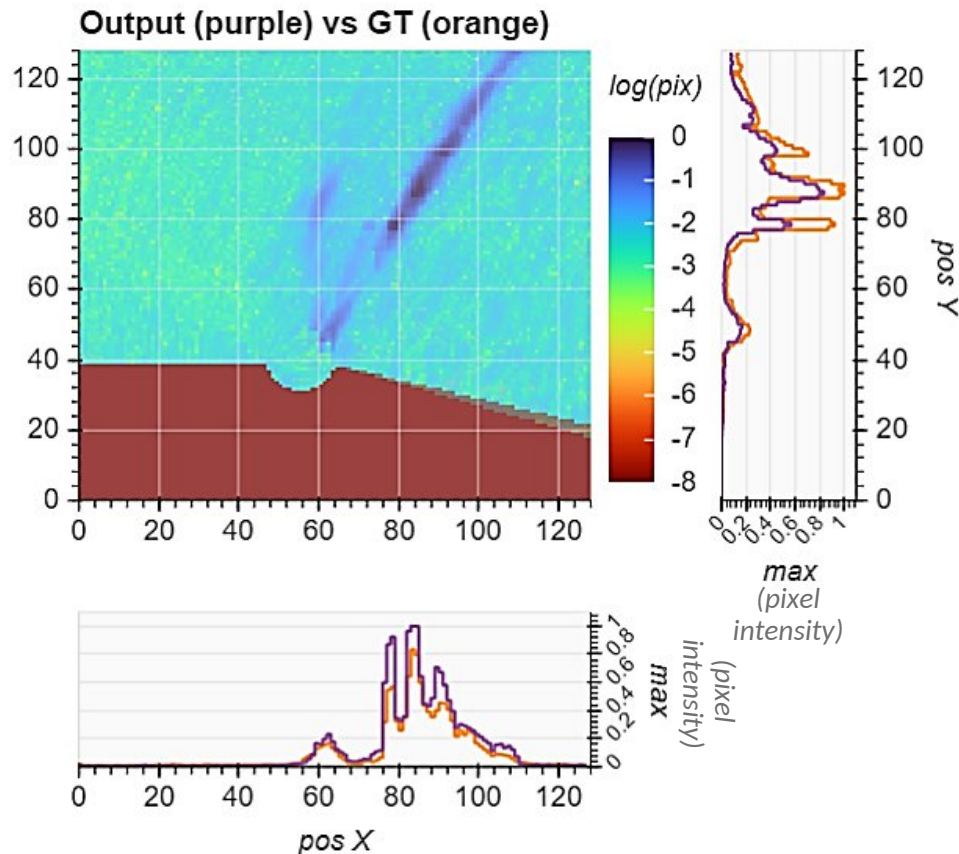
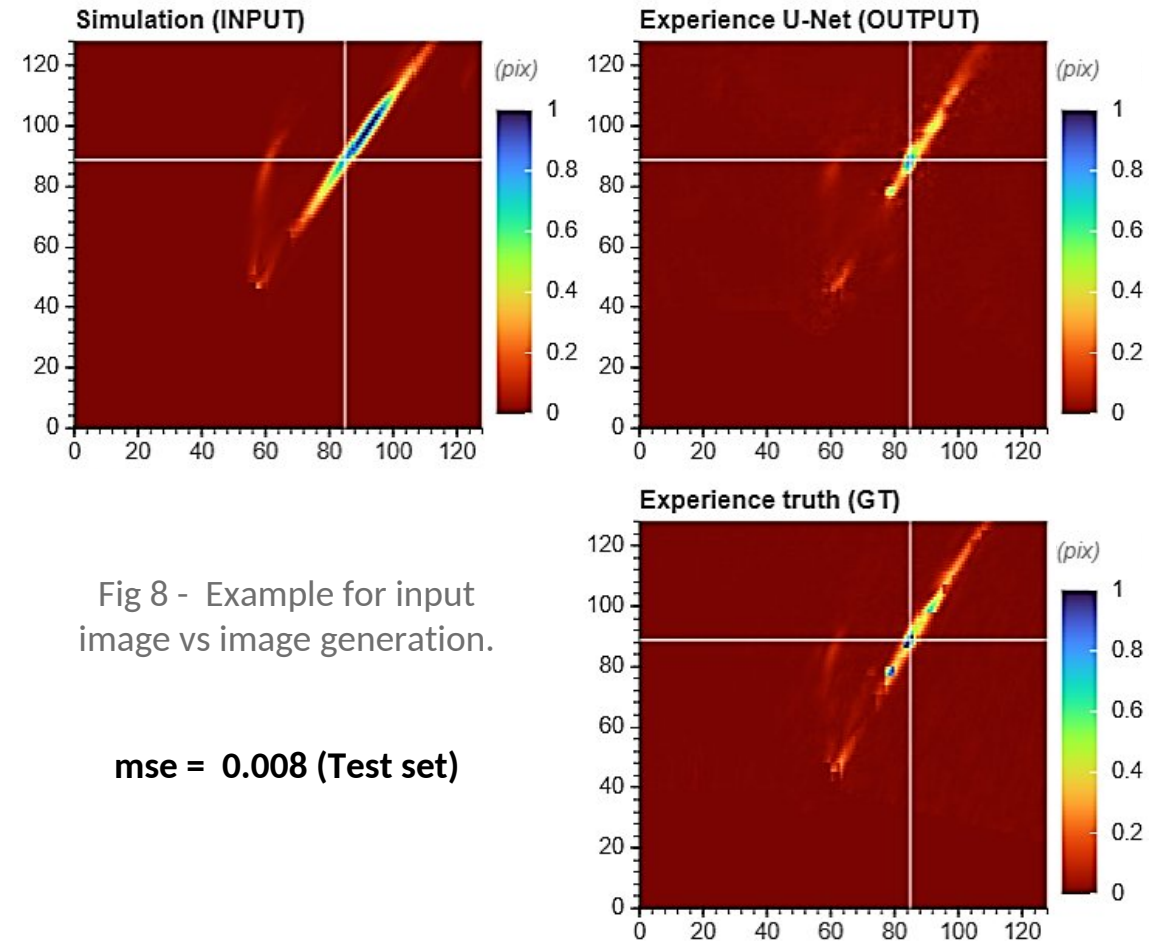

Fig 7 - Example for image generation vs ground truth. Comparison of maximum pixel value and (x,y) position.

$X_{\text{test}} + Y_{\text{test}} \rightarrow \text{cU-NET} \rightarrow X_{\text{e_test}}$

SIMULATION

EXPERIENCE



cU-Net as multifidelity generator

Echo amplitude

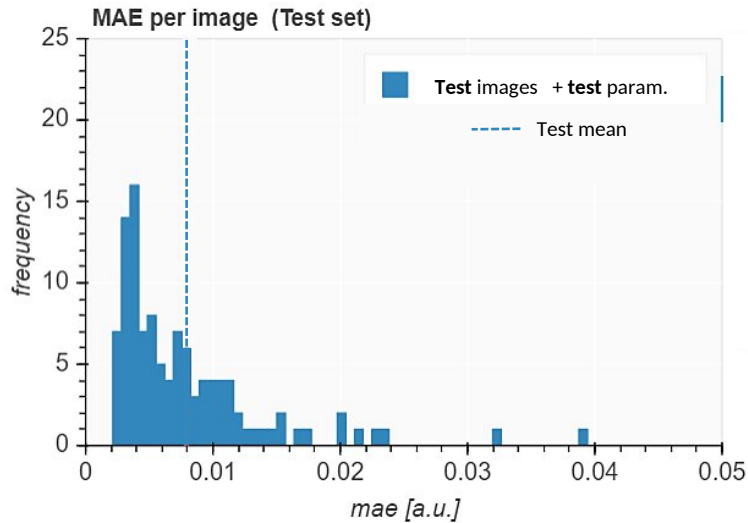
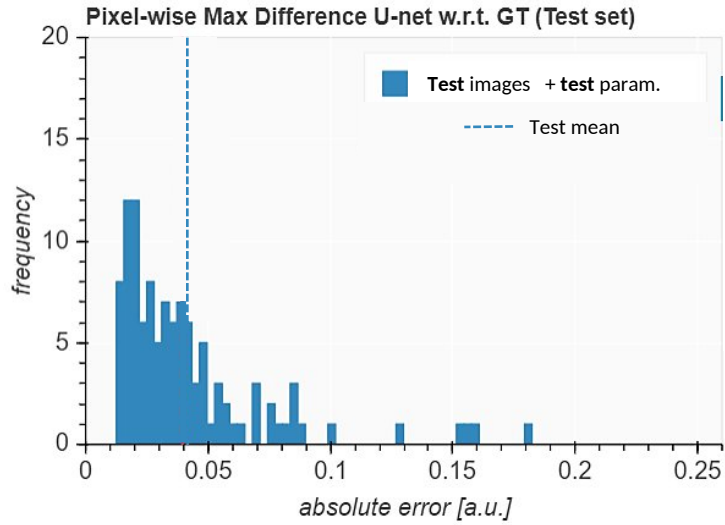

SIMULATION

EXPERIENCE

Echo localisation

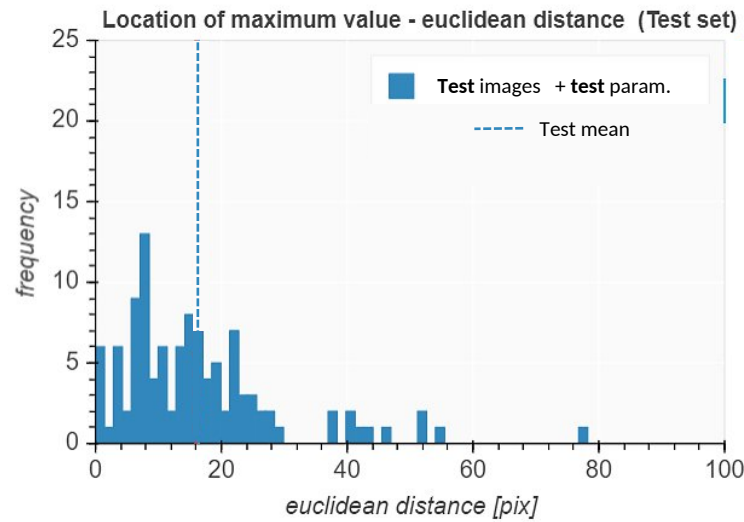

$X_{S_{test}} + Y_{S_{test}}$ → cU-NET → $X_{e_{test}}$

Experience U-Net (OUTPUT)

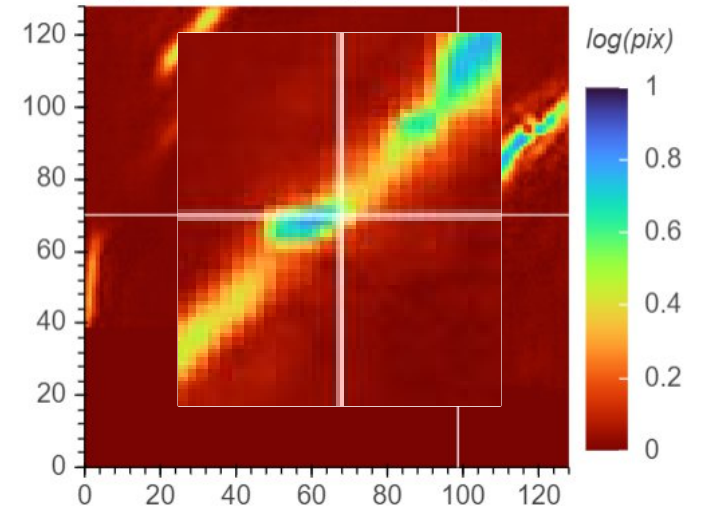

Experience truth (GT)

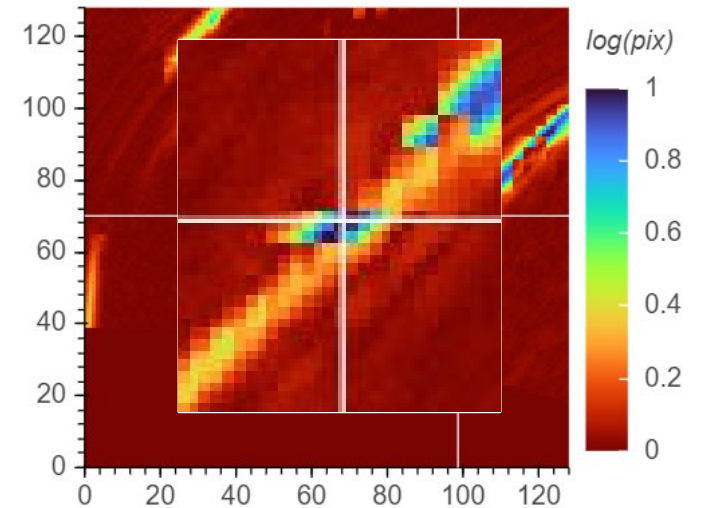

cU-Net as multifidelity generator

Sampling from simulation parameter space

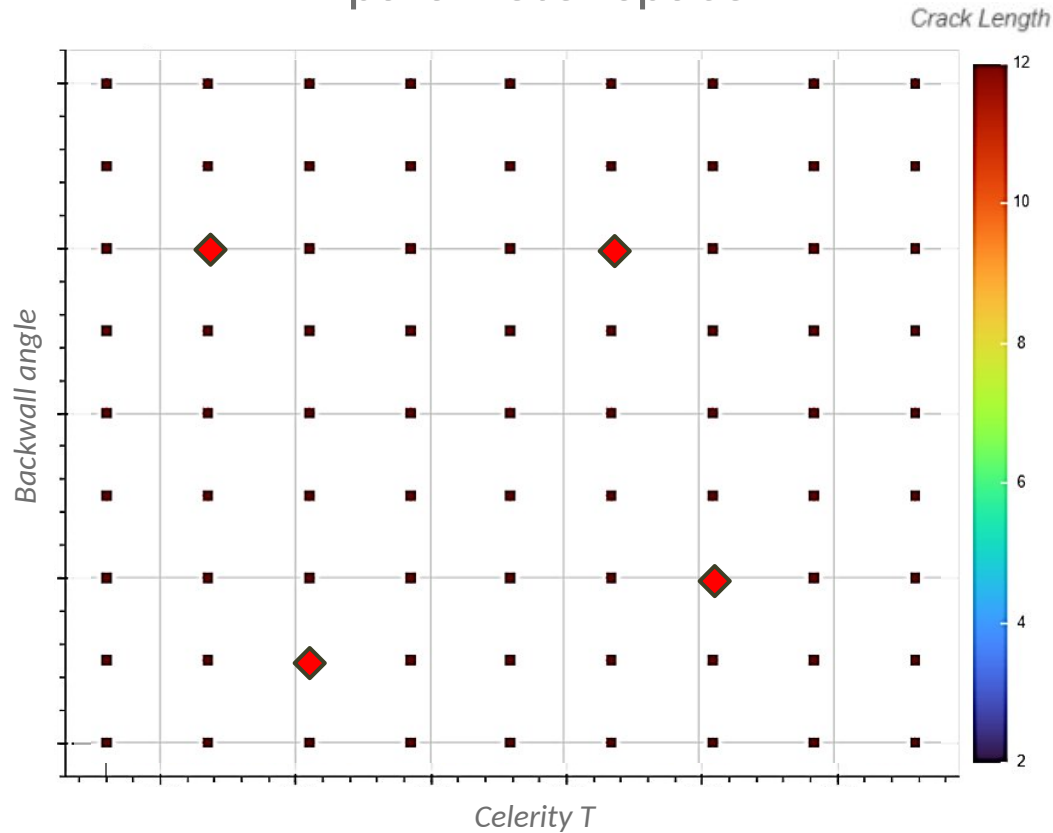

◆ Examples of points is test set

■ Examples of points is training set



New simulated samples

A point represents: simulated image + parameters vector

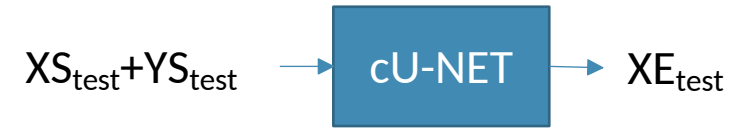

New generated dataset

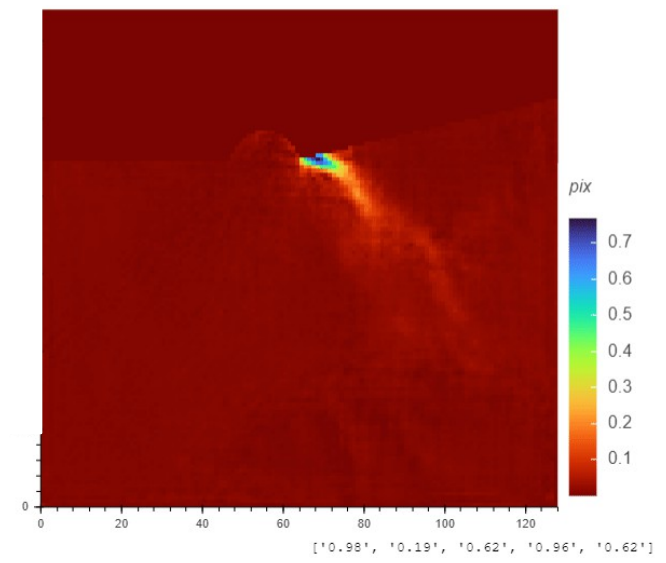
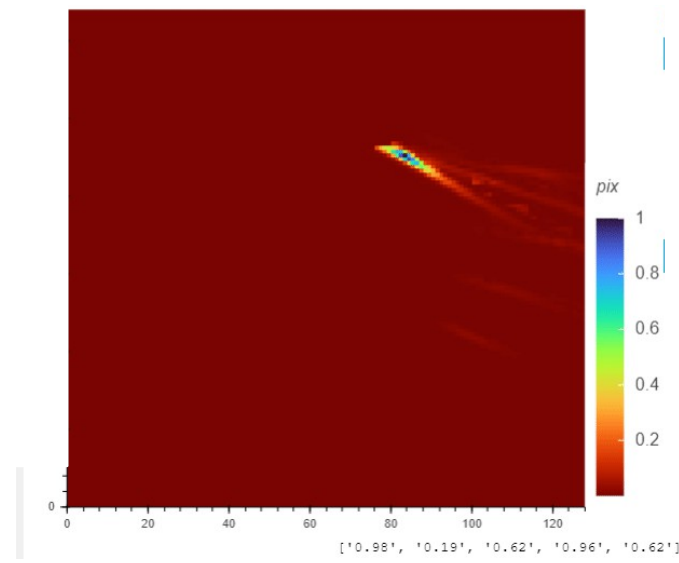

cU-Net surrogate model - *regression in parameter space (labels)*

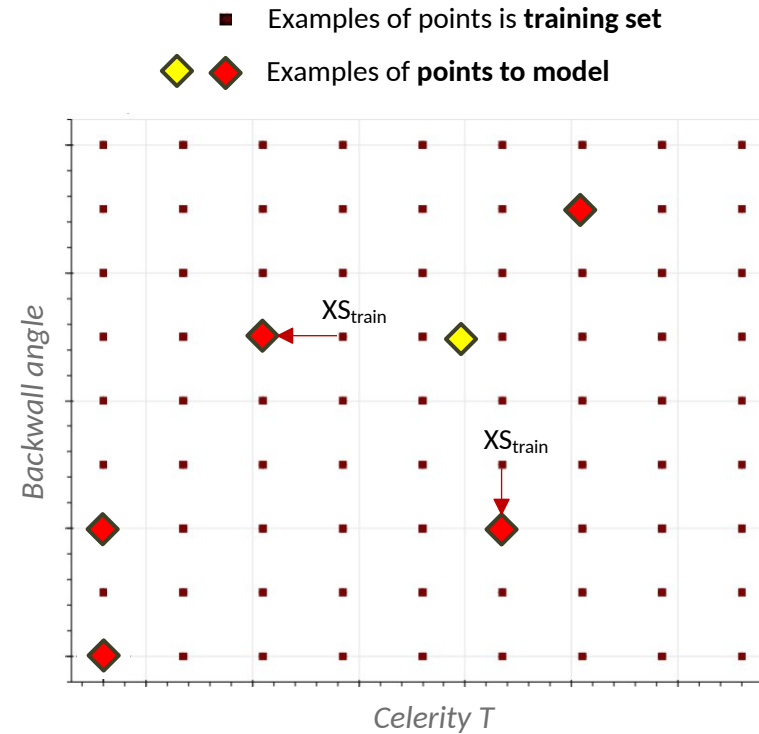
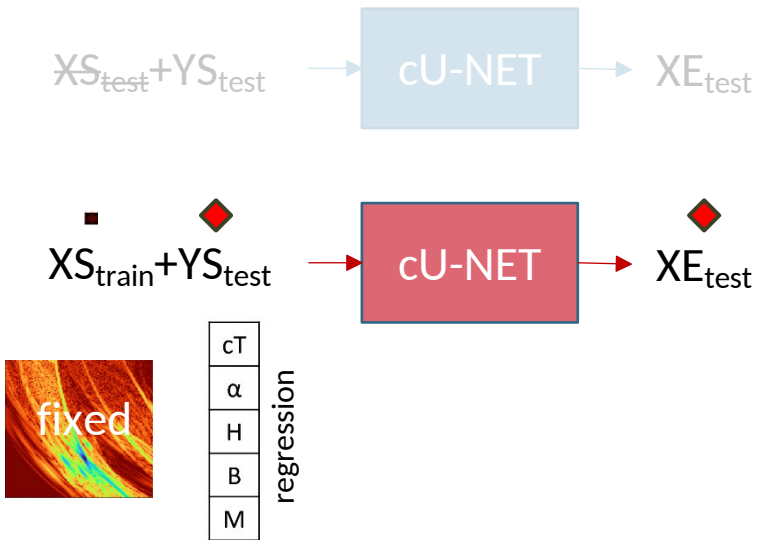

The neural network has a parametric input that modifies the input image in relation to the input parameters.

Can we sample the parameter space to generate **new images** related to **new labels**?

Echo localisation

Output (purple) vs GT (orange)

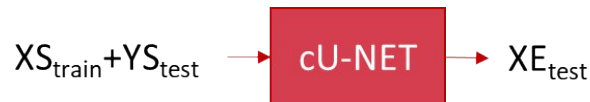
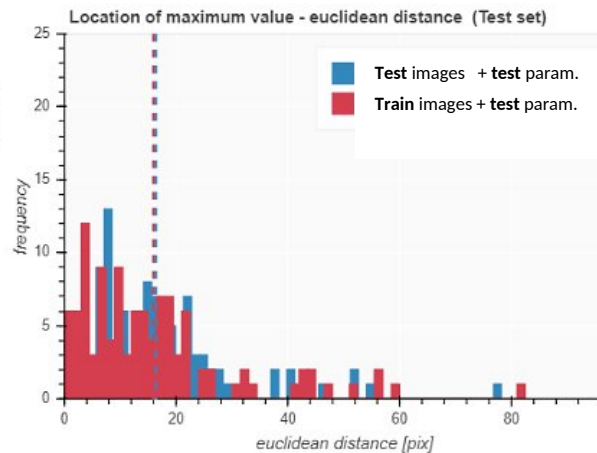
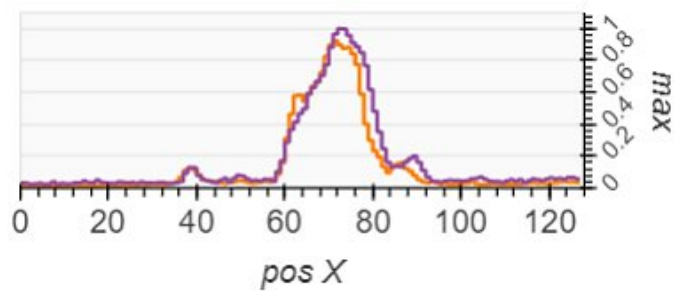
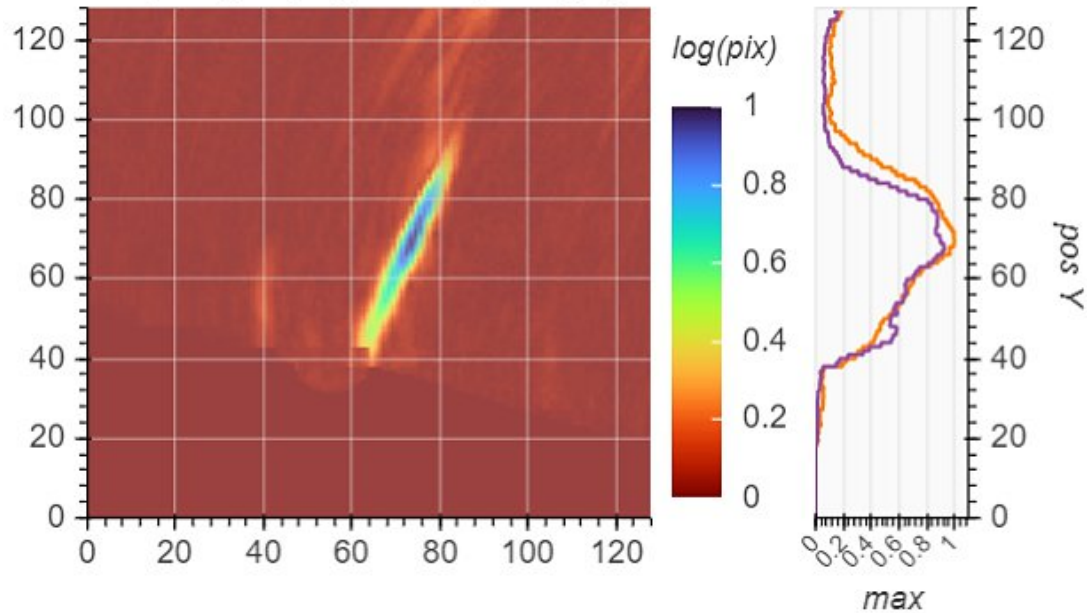

Echo amplitude

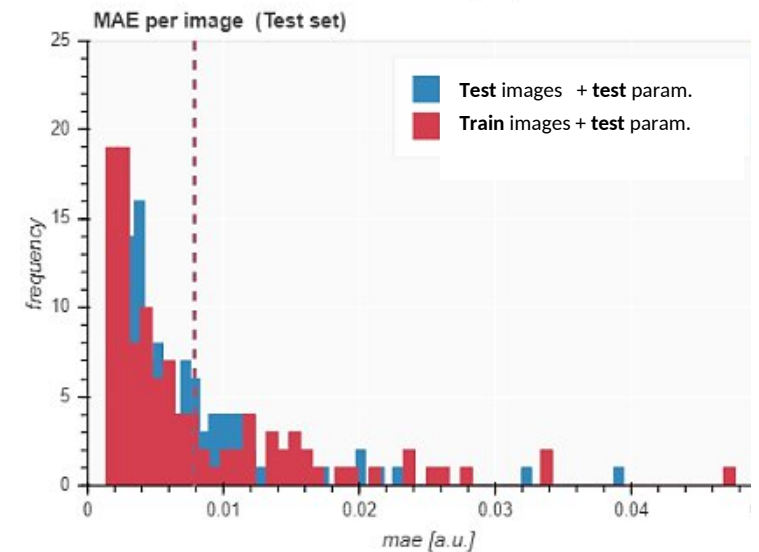
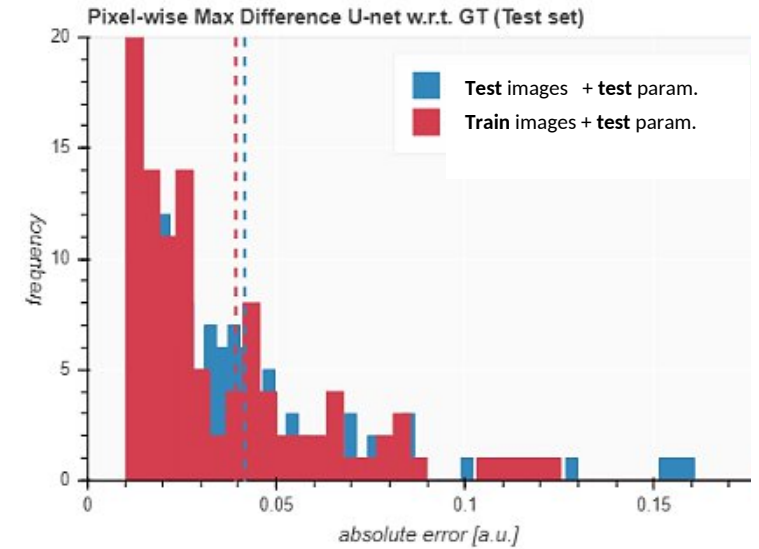

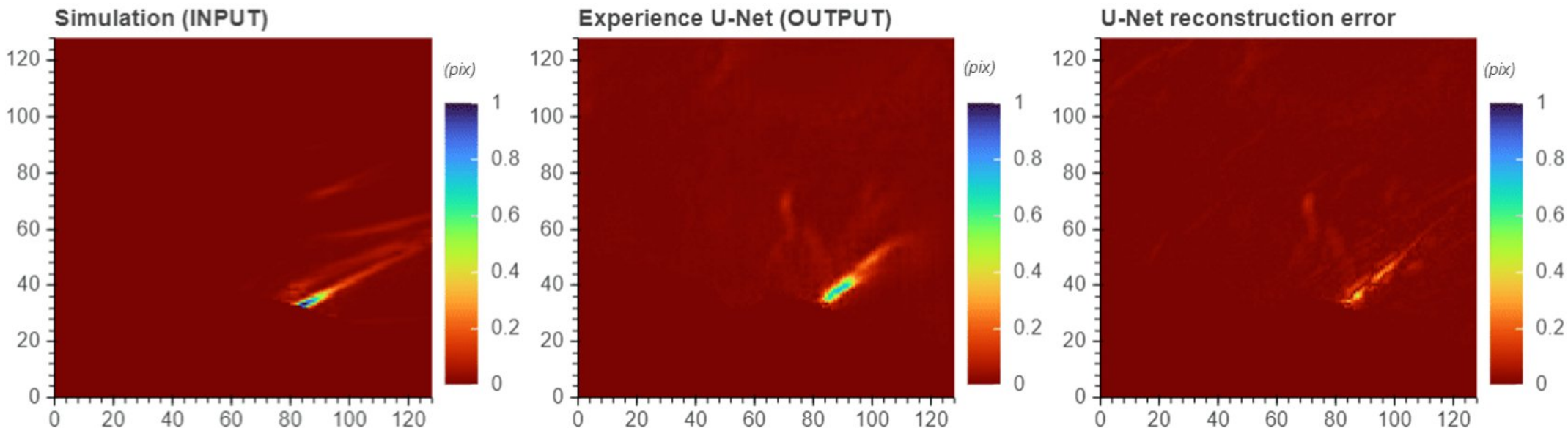

cT
α
H
B
M

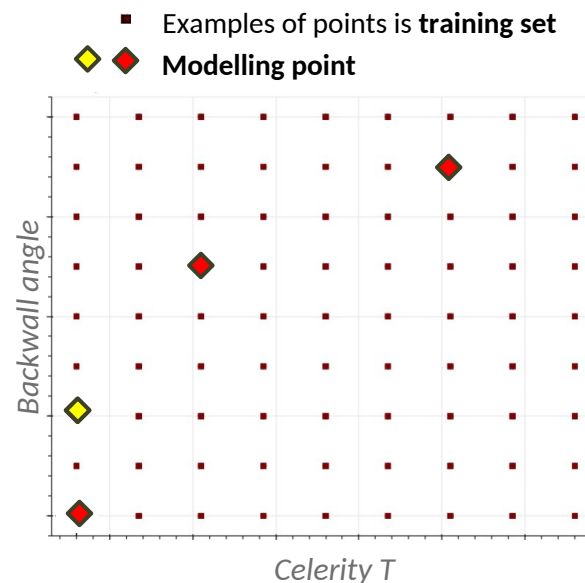
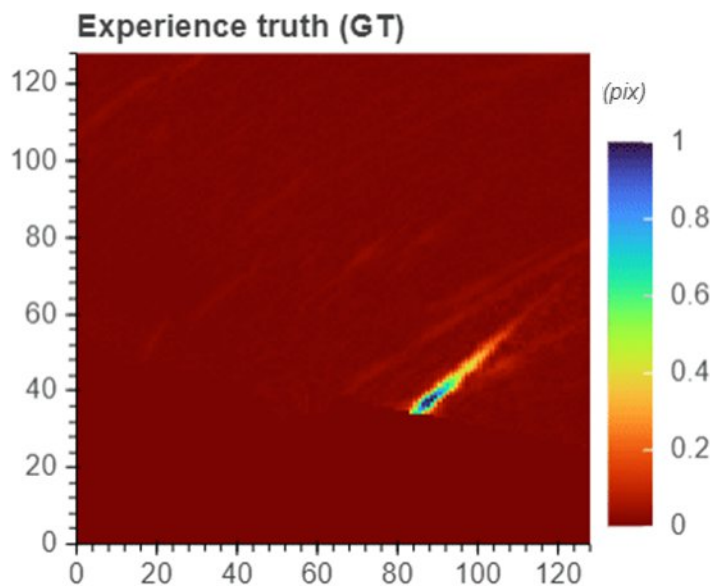

Echo localisation

Output (purple) vs GT (orange)

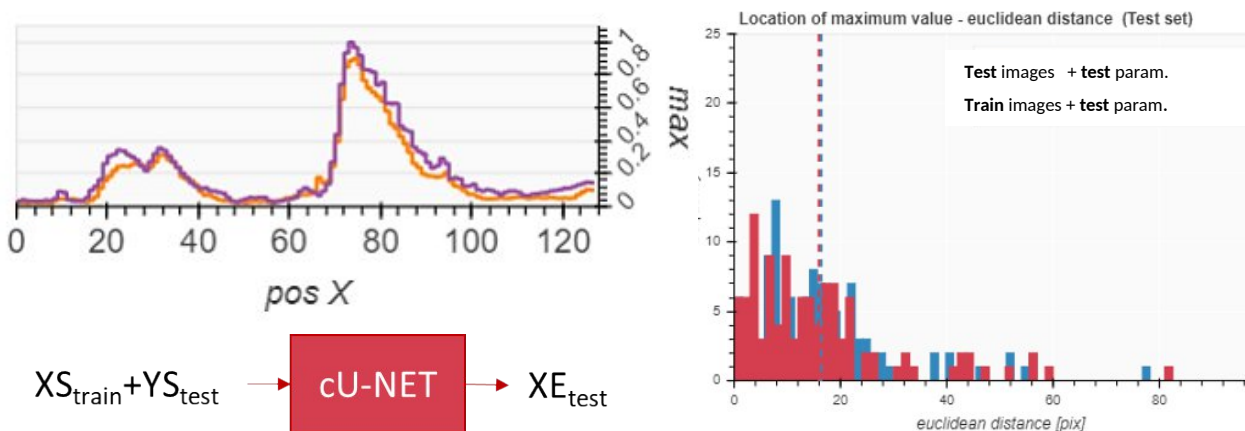
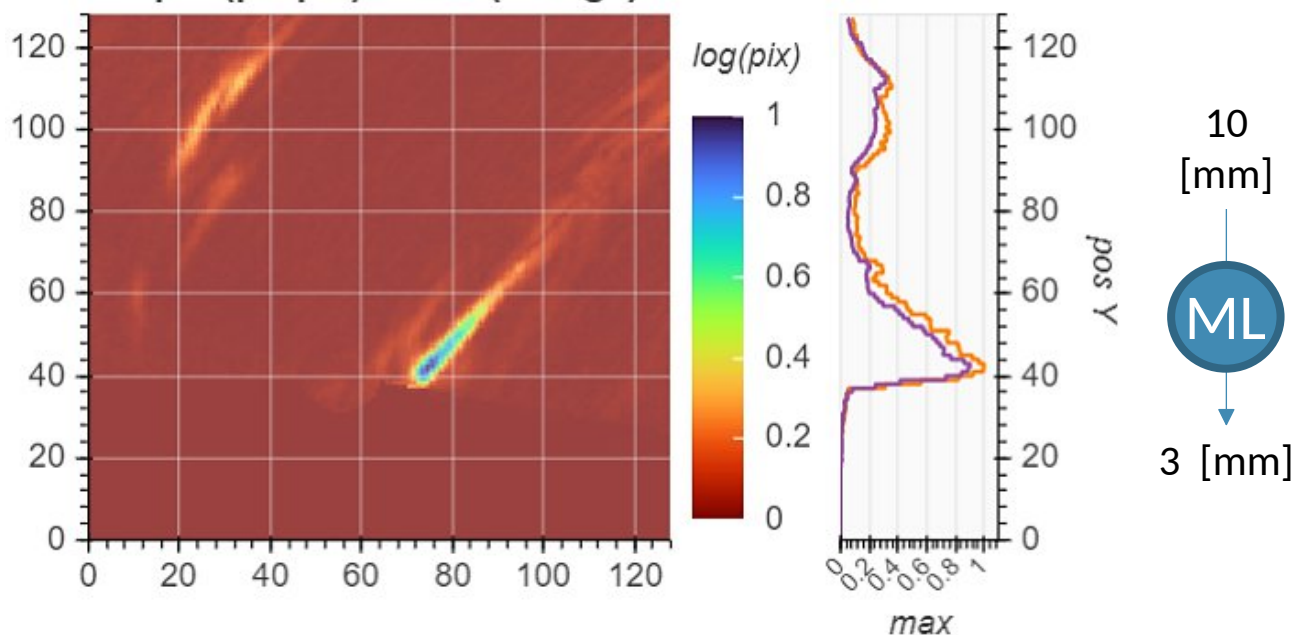

Echo amplitude

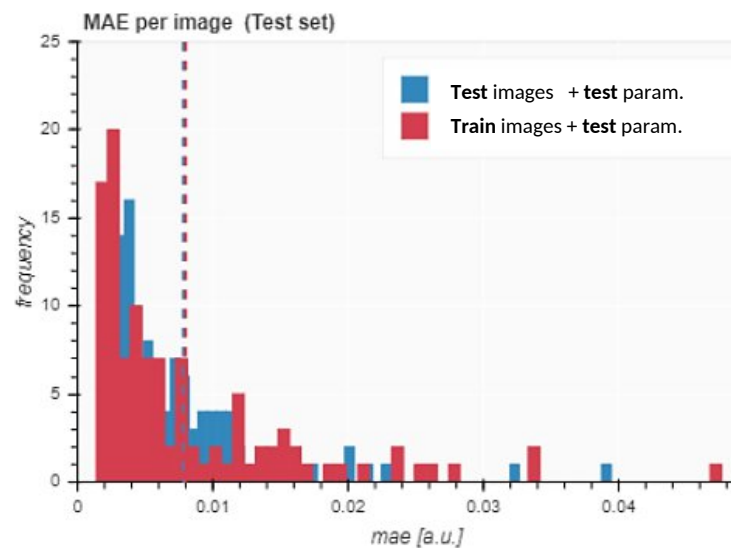
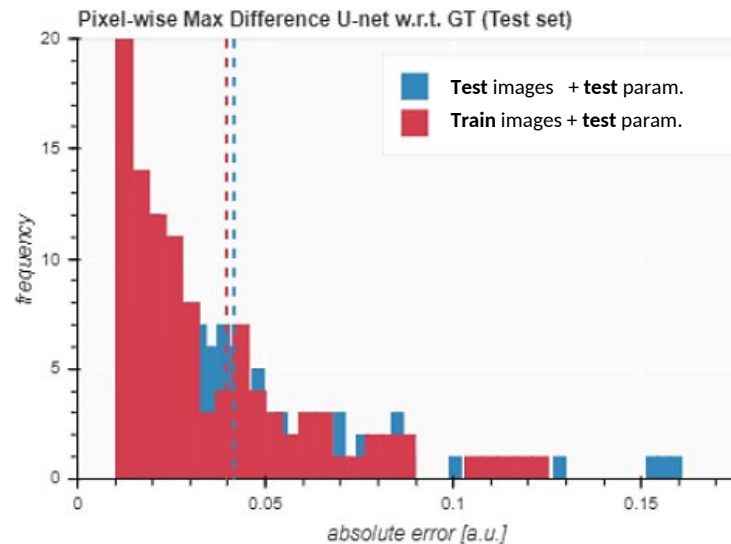

Conditional U-Net as generator on TFM data (supervised)

Features exploration

Latent space exploration

U-MAP representation 8x8x256 \hookrightarrow 2D

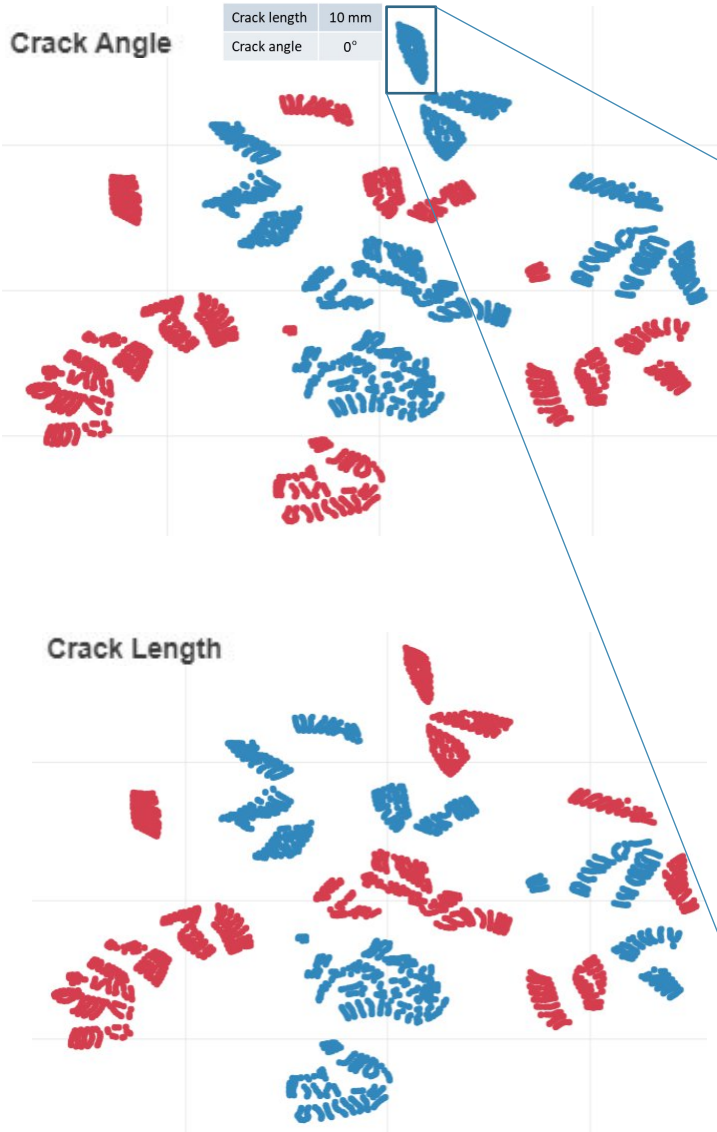
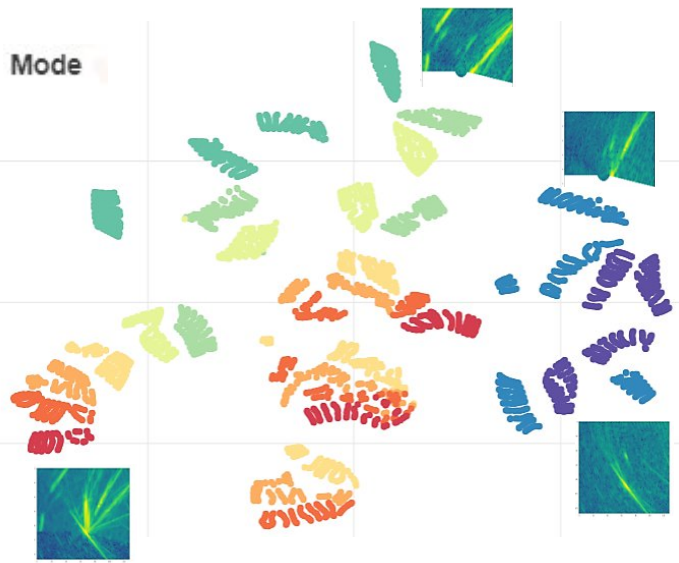
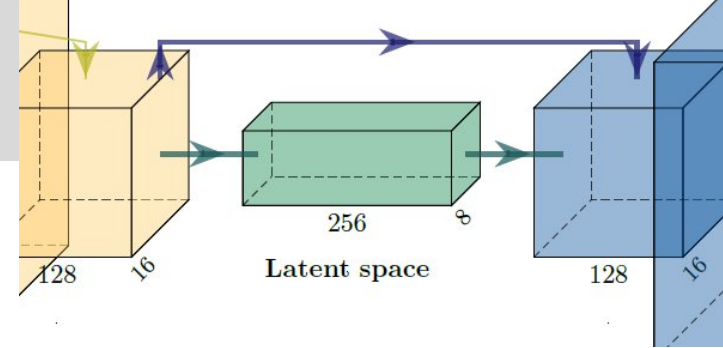

Crack length	10 mm
Crack angle	0°

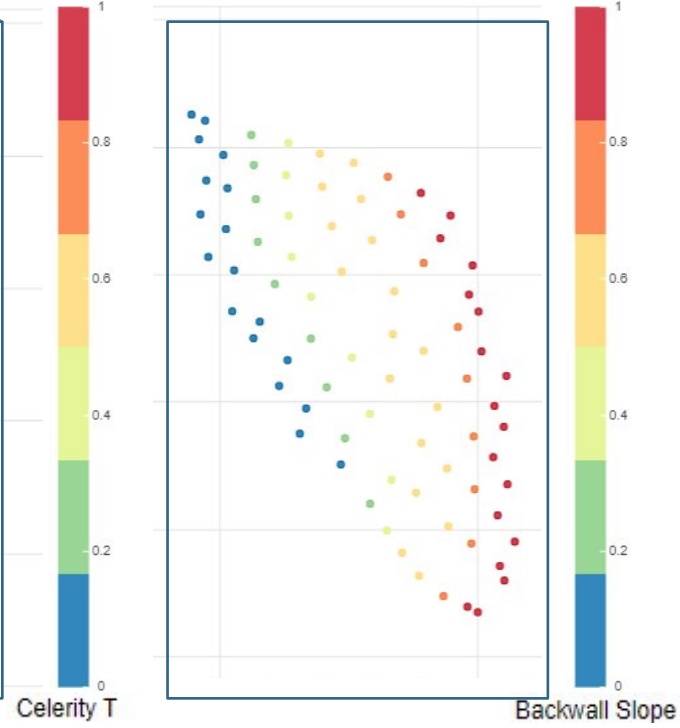
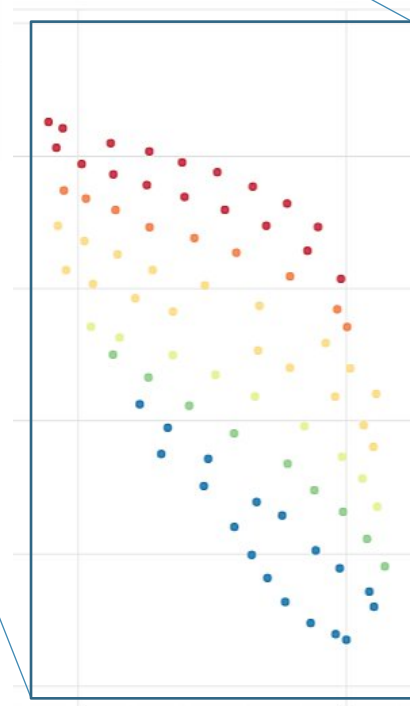

UMAP constructs a high dimensional graph representation of the data then optimizes a low-dimensional graph to be as structurally similar as possible

Conclusion

- 🧑‍🔬 **Multitask neural network**: 9 TFM reconstruction modes are learned. New modes requires DA or new training.
- 🧑‍🔬 The model takes as HF domain the experience. **Different degrees of data fidelity on HF side** can be considered (e.g: FEM).
- 🧑‍🔬 A **novel application of ST and FiLM modules** is presented to learn parametric subrogated model on ML frame.
- 🧑‍🔬 Relation between NDT image features and the simulation parameter are learned by the model.
The architecture is **not limited by the shape of the parameter vector**.
- 🧑‍🔬 Parametric **metamodeling** allows to generate new “**experimental**” instances, even without new simulation instances.
- 🧑‍🔬 Regression on label space provides **direct labelling for new data**.

Perspectives

- 🧑‍🔬 **cU-net as realistic data generator** for data-set creation provides the tool to have enough data to train deeper models:
GAN as variational inference tool to link two fidelity data domains (e.g.: simulation and experience)
- 🧑‍🔬 GAN approach is pertinent when **couples on each fidelity domain are not informed**.

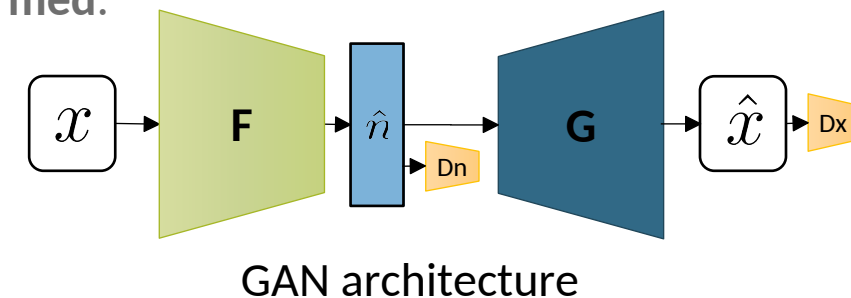



Merci de votre attention

Thanks you for you attention

Gerardo E. Granados

Contact mail:

gerardo.granados@cea.fr

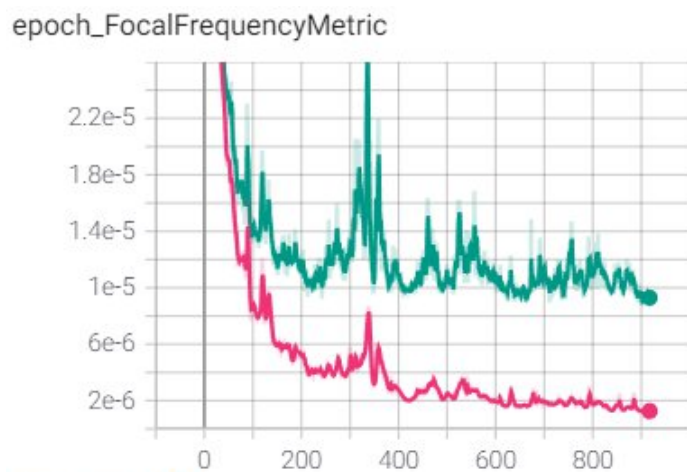
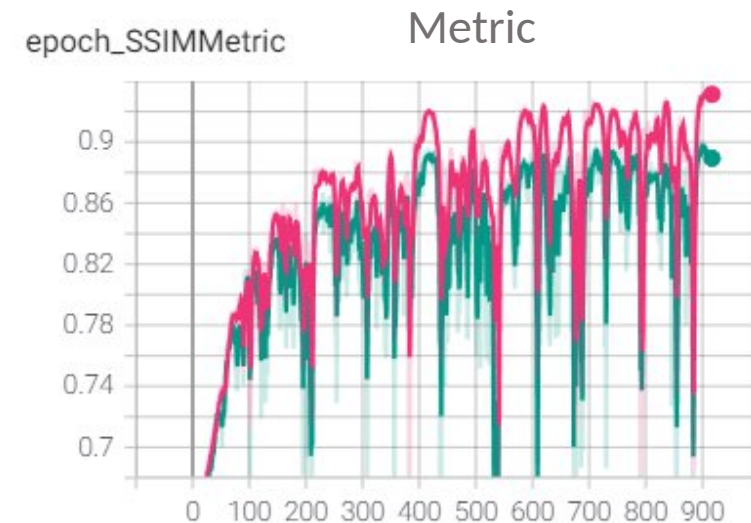
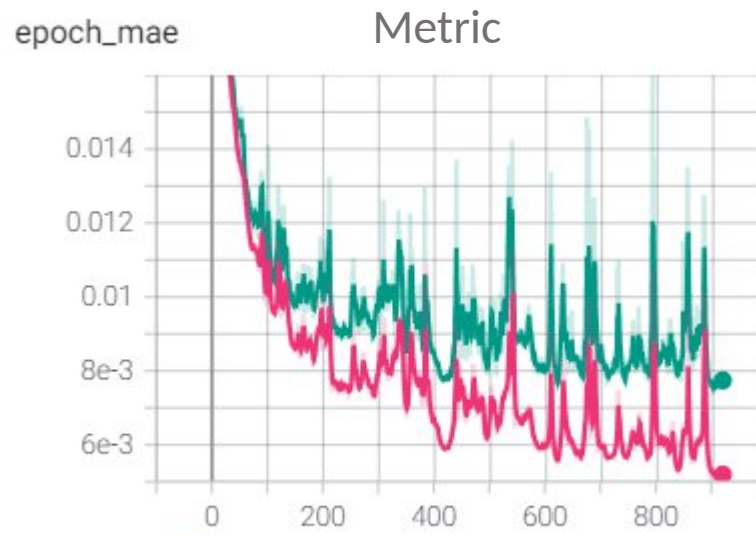
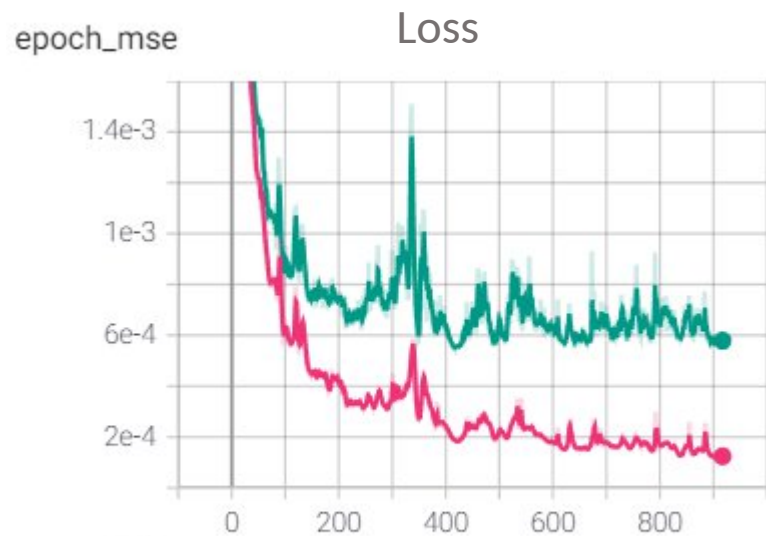

— Training
— Validation

4h sur GPU
NVIDIA Quadro RTX 6000
Batch 128
22 GB on GPU

