



HAL
open science

Fast plastic scintillator and SiPM based devices for FLASH beams monitoring

Mathieu Agelou, Guillaume Bertrand, Guillaume Boissonnat, Anthony Bonfrate, Victor Buridon, Sophie Heinrich, Savneet Kaur, Clement Lynde, Jorrel Jodel Nahimana, Anna Lisa Patriarca, et al.

► To cite this version:

Mathieu Agelou, Guillaume Bertrand, Guillaume Boissonnat, Anthony Bonfrate, Victor Buridon, et al.. Fast plastic scintillator and SiPM based devices for FLASH beams monitoring. International Symposium on Innovative Radiation Therapies (INSIRT), Oct 2023, Orsay, France. cea-04393952

HAL Id: cea-04393952

<https://cea.hal.science/cea-04393952v1>

Submitted on 15 Jan 2024

HAL is a multi-disciplinary open access archive for the deposit and dissemination of scientific research documents, whether they are published or not. The documents may come from teaching and research institutions in France or abroad, or from public or private research centers.

L'archive ouverte pluridisciplinaire **HAL**, est destinée au dépôt et à la diffusion de documents scientifiques de niveau recherche, publiés ou non, émanant des établissements d'enseignement et de recherche français ou étrangers, des laboratoires publics ou privés.



Fast plastic scintillator and SiPM based devices for FLASH beams monitoring

V. Buridon



**INTERNATIONAL SYMPOSIUM
ON INNOVATIVE RADIATION
THERAPIES
October 5-7, 2023**

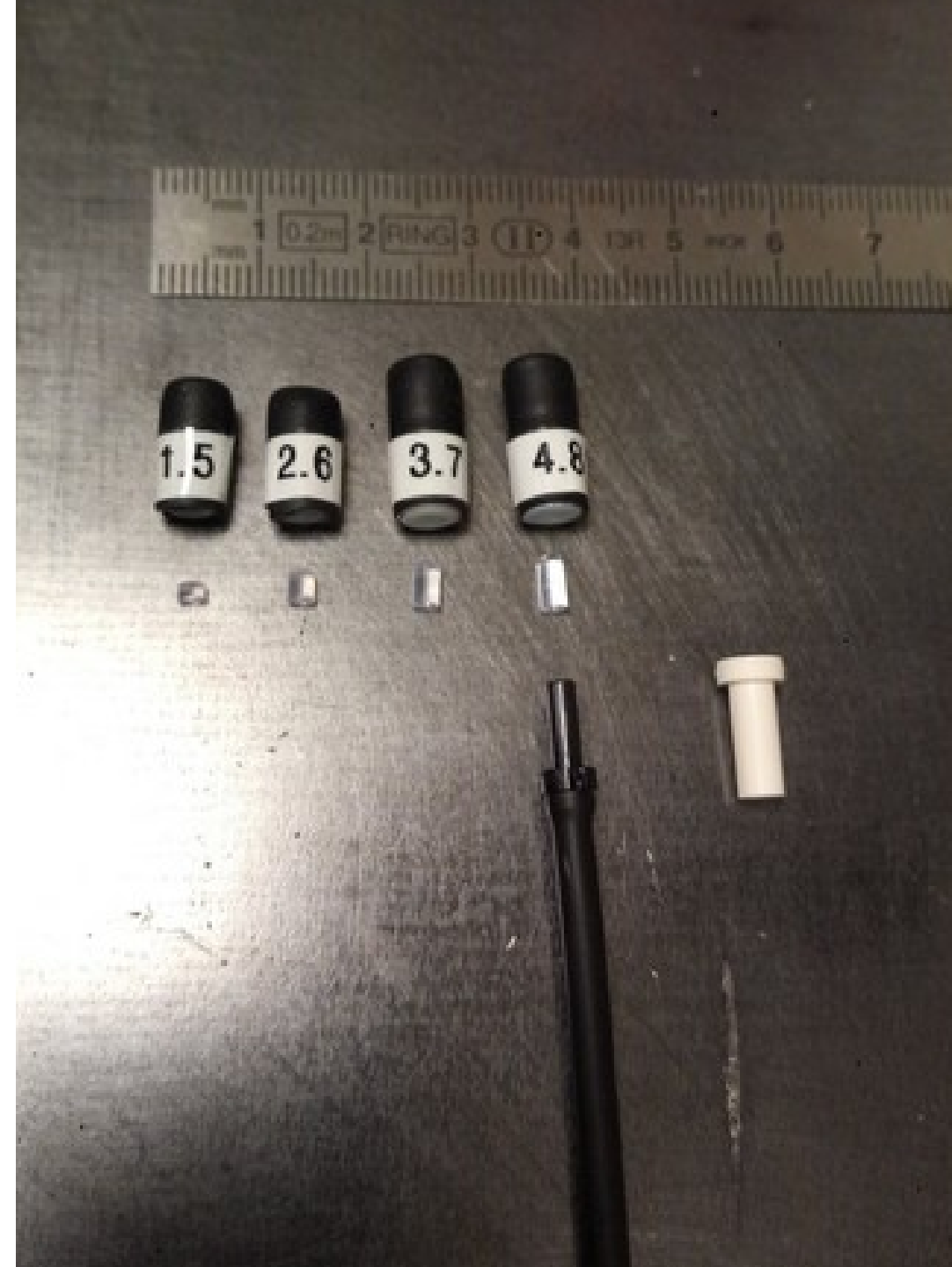

Summary

1.Context

2.Motivations and contents

3.Results

4.Conclusions and future developments





1 ■ Context

General context

Treatments techniques against solid tumors

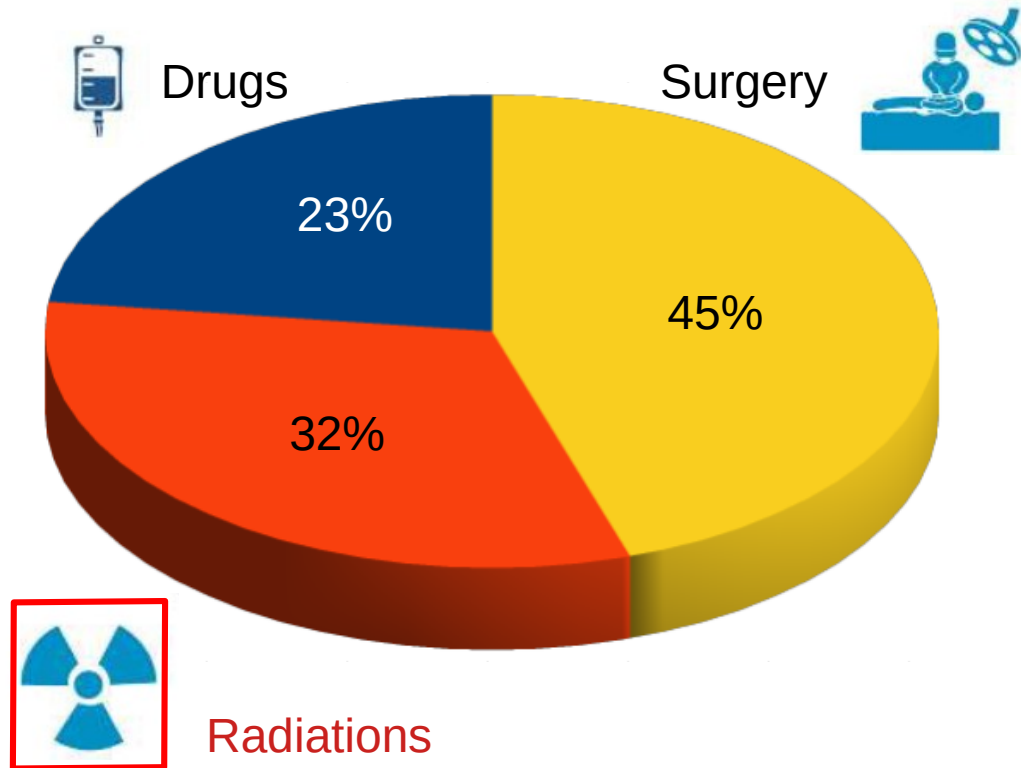

Techniques used in conformal radiotherapy

- **LINACS with low energy e^- beams.**
- LINACS with intra-operative e^- RT.
- Carbon ions (high LET particles).
- Protons beams (cyclotrons ...).
- Very High Energy e^- beams (VHEE).
- X rays (synchrotron or X ray tubes).

➔ **Conventional and FLASH Beams**

FLASH therapy : Improvement of the dose delivery to the tumors while sparing healthy tissues [Favaudon 2014].

Conventional and FLASH Beams



- Install in September 2020 in Centre de Recherche – Orsay



- Electrons 5MeV or 7MeV.
- 2 modes : conventional and FLASH.
- Specific monitor system for each mode.
- Field size between 12cm and 1cm of diameter (applicators).
- Dose rate between 0.1-1000Gy/s on the field of diameter 10cm.
- Dose/pulse : [1,25] Gy/pulse.

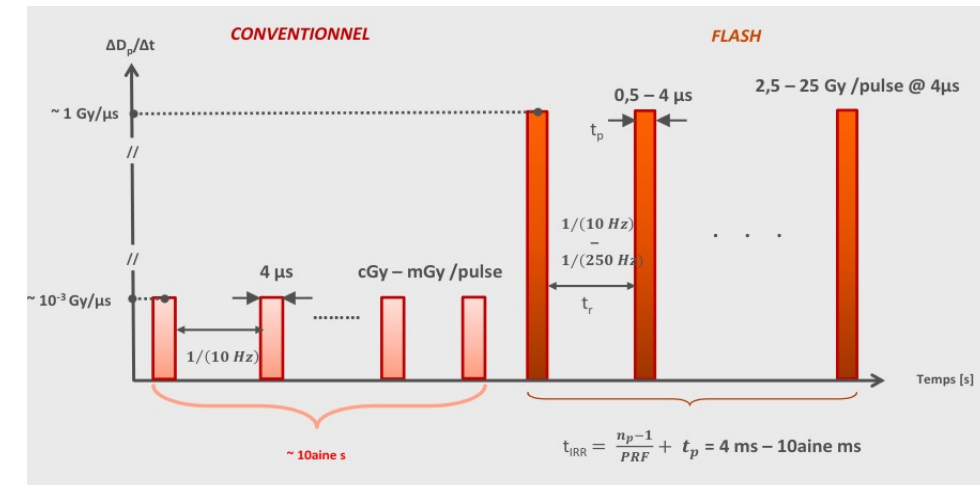



2 ■ Motivations and contents

Problematic

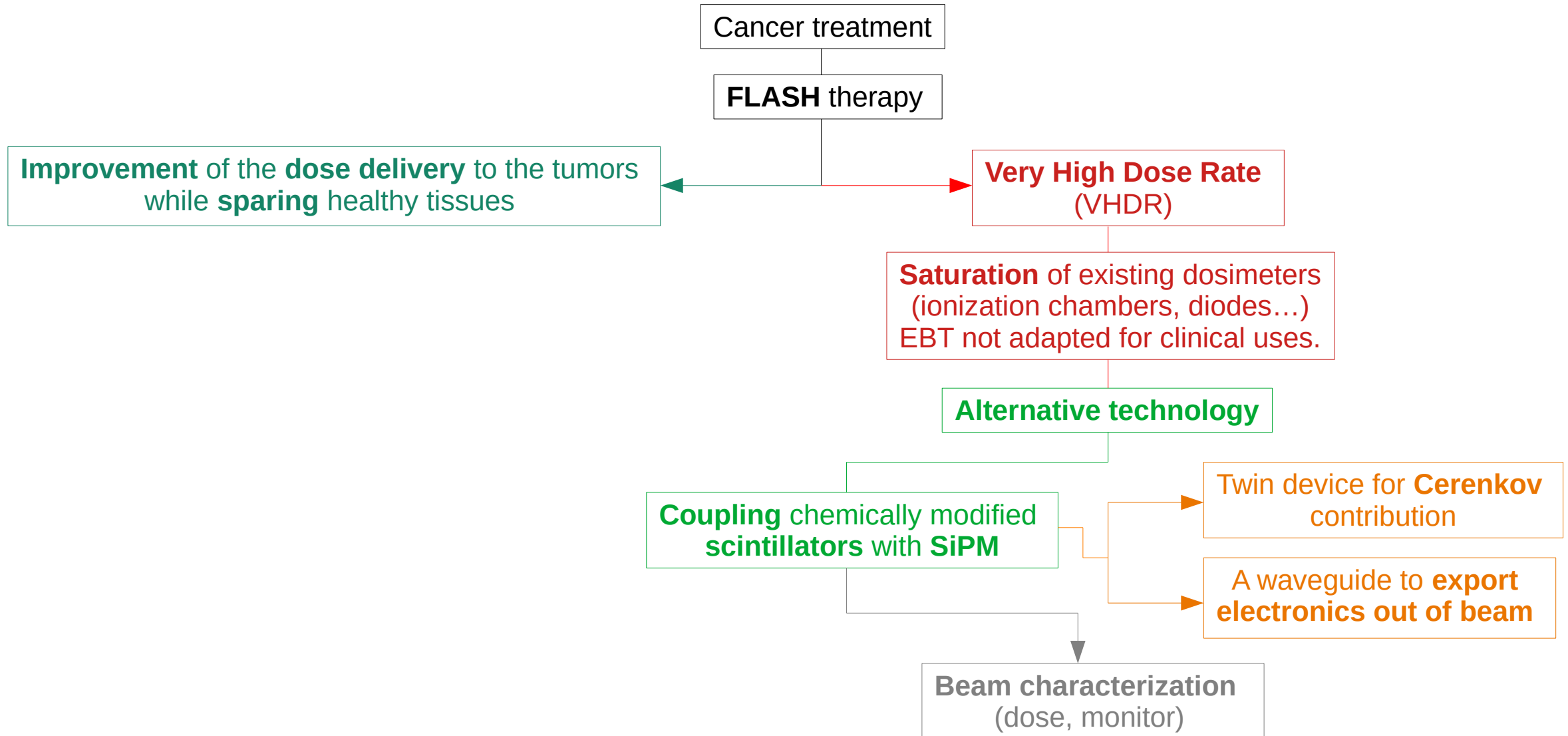

Dosimeters properties and specifications



ASTROLABE project : fAst ScinTillatoR based device for On line FLASH BEam dosimetry.

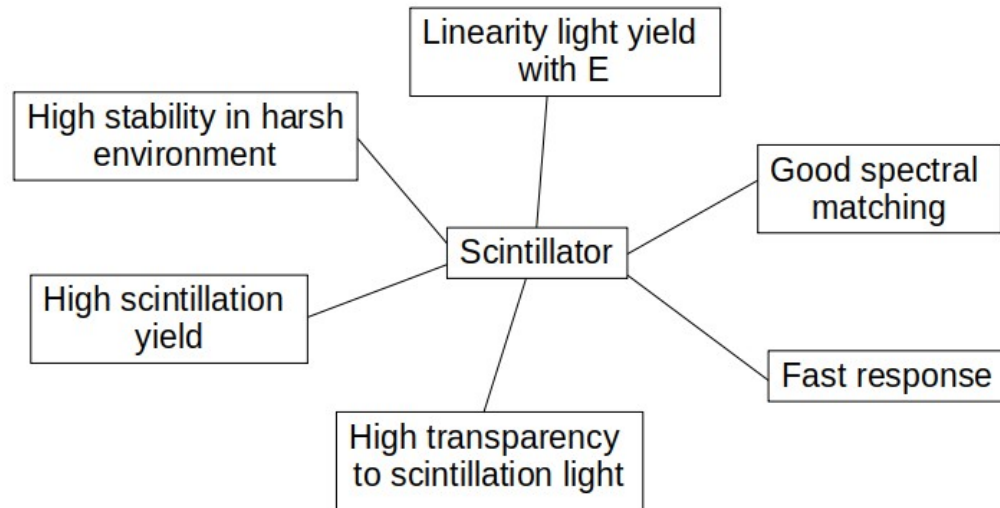

Point dosimeter specifications

- Temporal resolution : 5-10ns (1% of precision for a pulse of 1 μ s).
- $\lambda_{\text{emission}}$: [420-600]nm.



3 ■ Results

Fast plastic scintillators synthesis



1) Plastic scintillators chemical composition

Polymer matrice

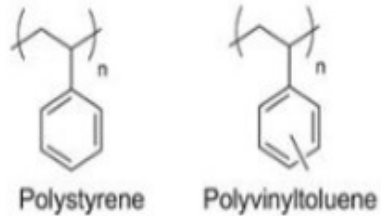

Primary fluorophore

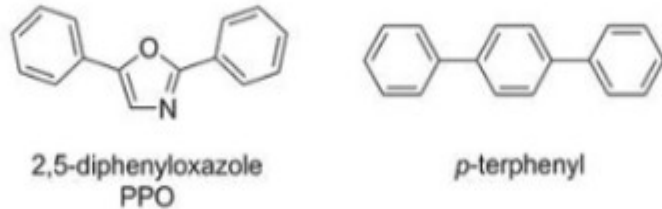

Secondary fluorophore

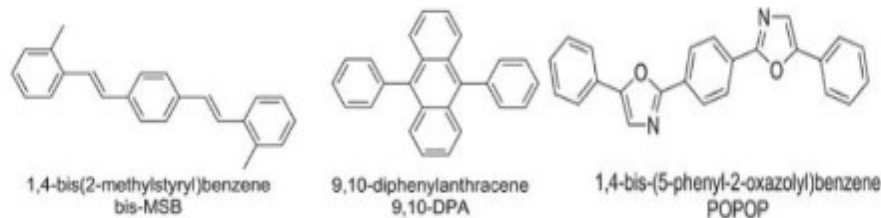

2) Fast plastic scintillators (chemically modified) properties

Scintillators	Chemical composition (%)	λ_{\max} emission (nm)
A	99.9% Styrene 0.1% CM30	474
B	99.9% Styrene 0.1% BBQ	389
C	99.9% Styrene 0.1% DCM	551
D	99.9% Styrene 0.1% PBD	382
E	96.9% Styrene 3% PPO 0.1% <u>bis-MSB</u>	445
F	99.9% Styrene 0.1% Pterphenyl	383

3) Objectives

- **Best light yield.**
- **Fastest response time.**

1) Scintillators to characterize

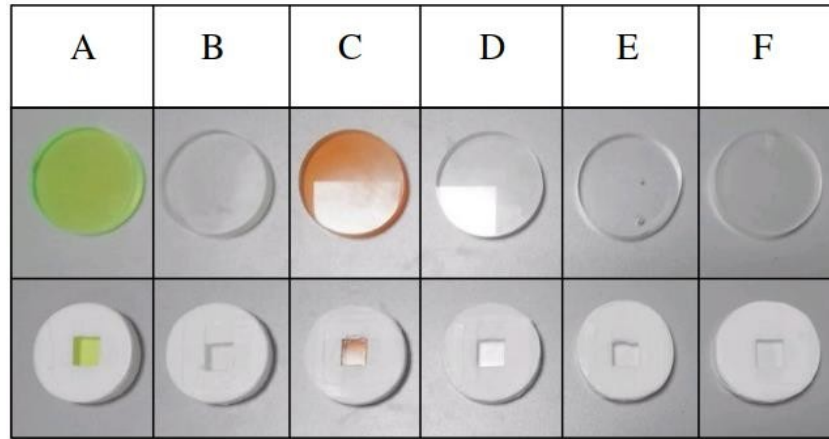

3) Associated energy spectra

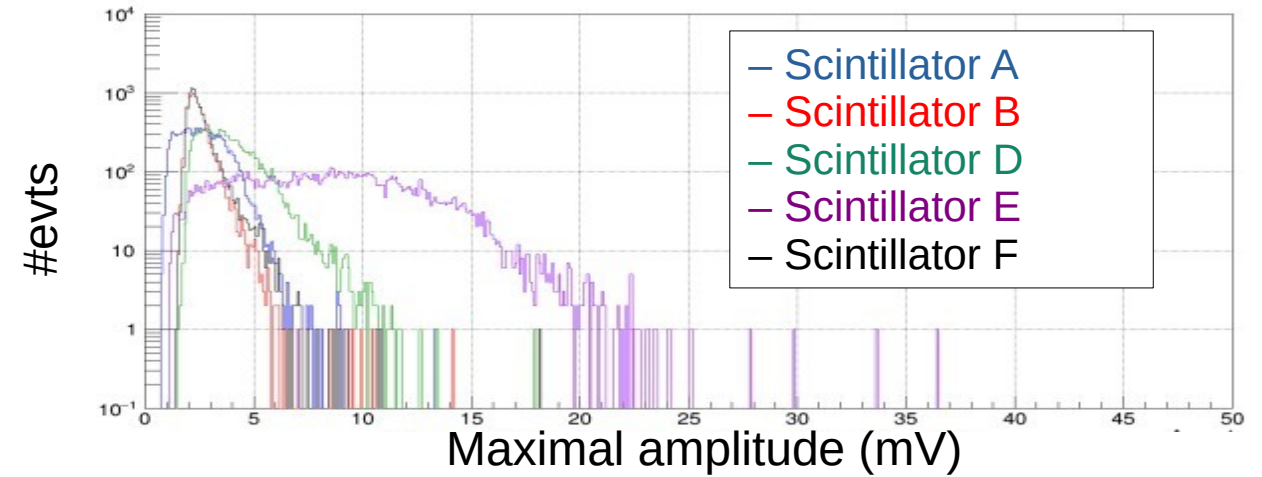

2) Radio-physical characterization bench

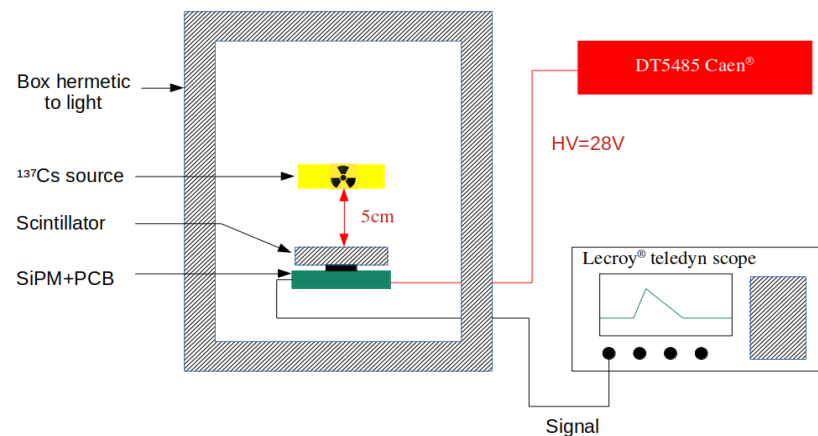

4) Rapidity of pulses

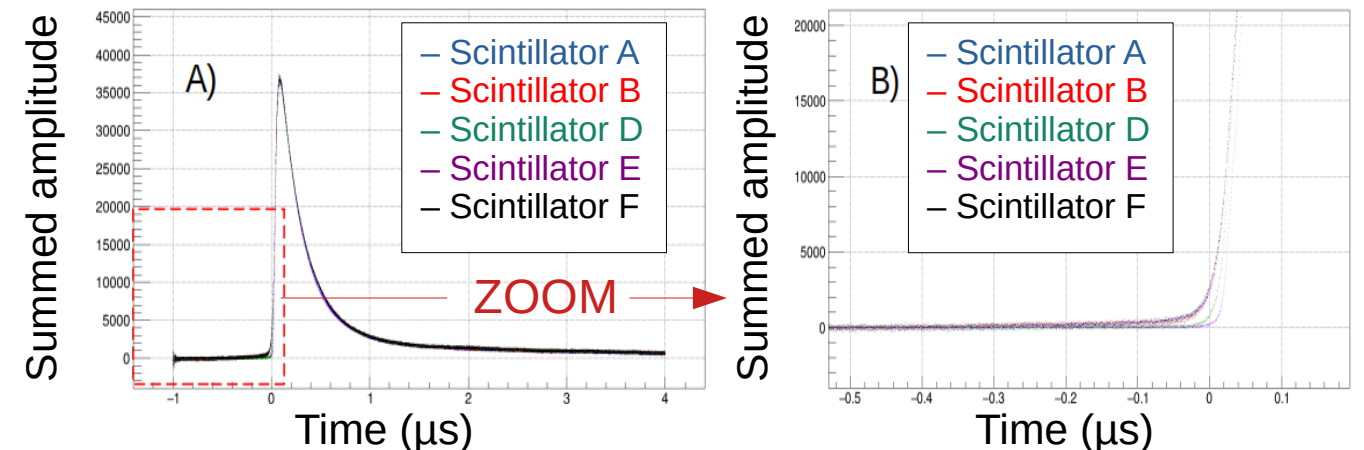

Set-up assembly (point dosimeters)



1) Point dosimeter operating diagram

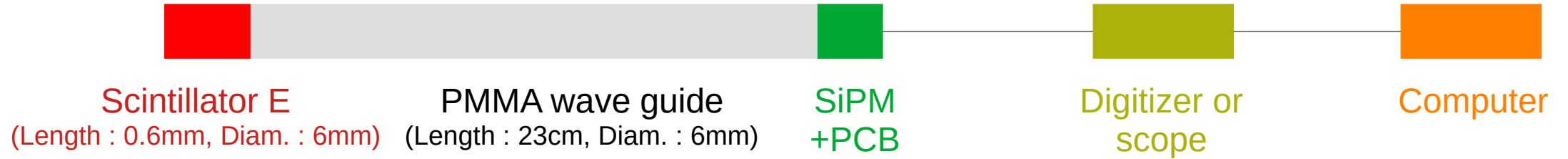

2) Point dosimeter assembly steps

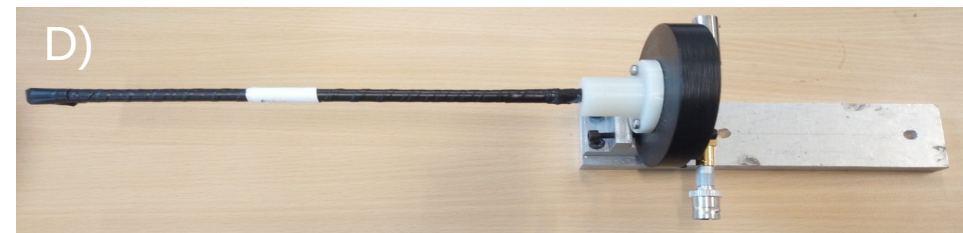
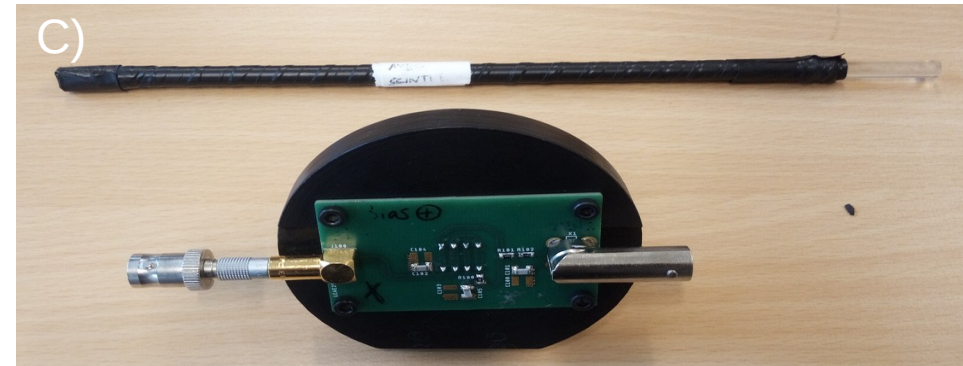
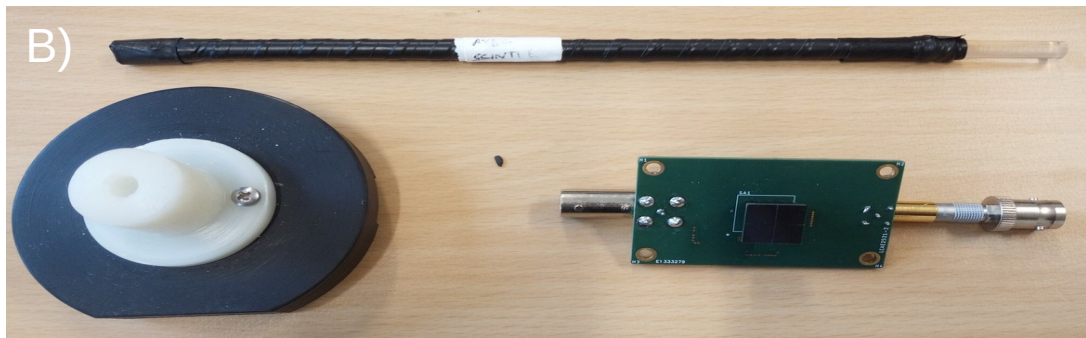
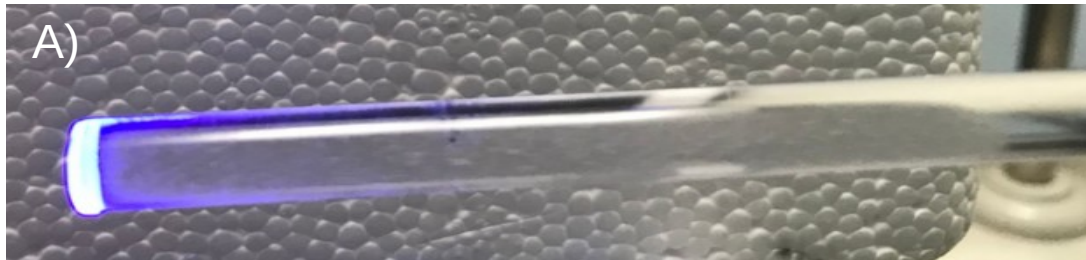

Measurements on FLASH Beam



1) Experience under FLASH Beams

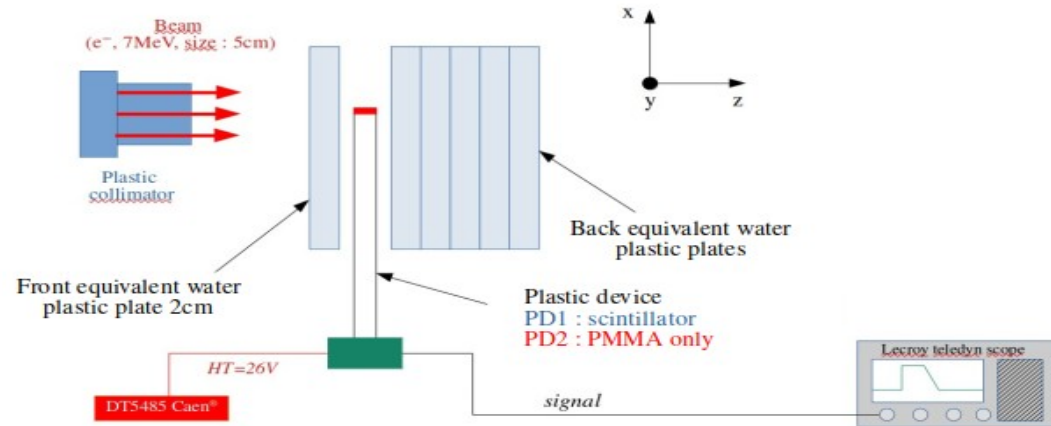

2) Output signals shape

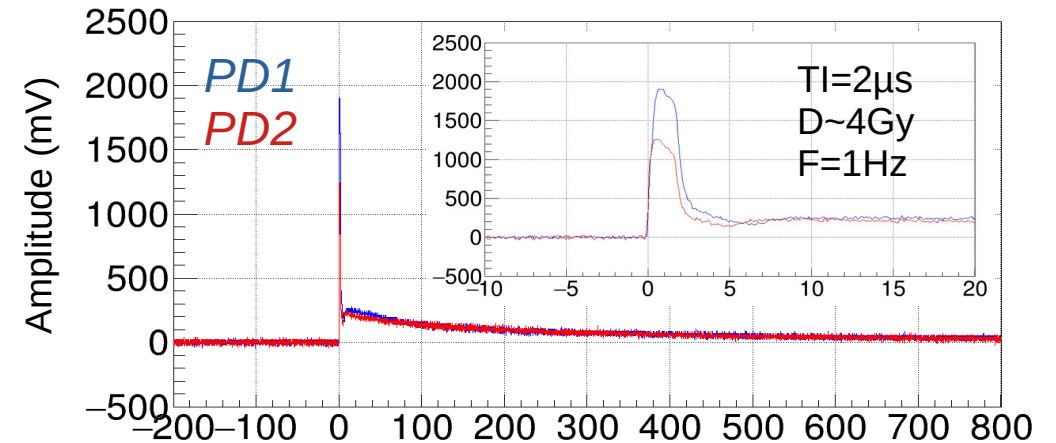

3) Cerenkov estimation

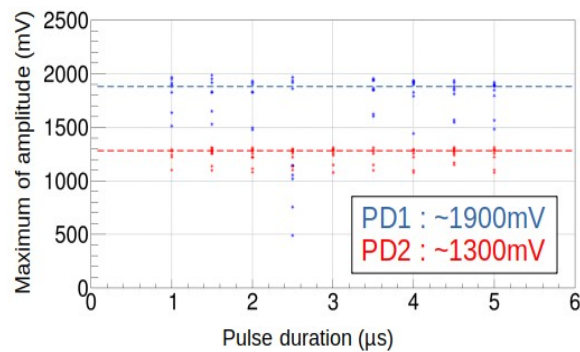

Cerenkov contribution = $13/19 = 68.42\%$

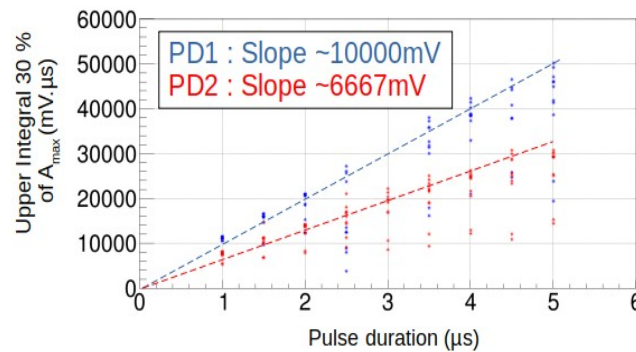

Cerenkov contribution = $6.67/10 = 66.67\%$

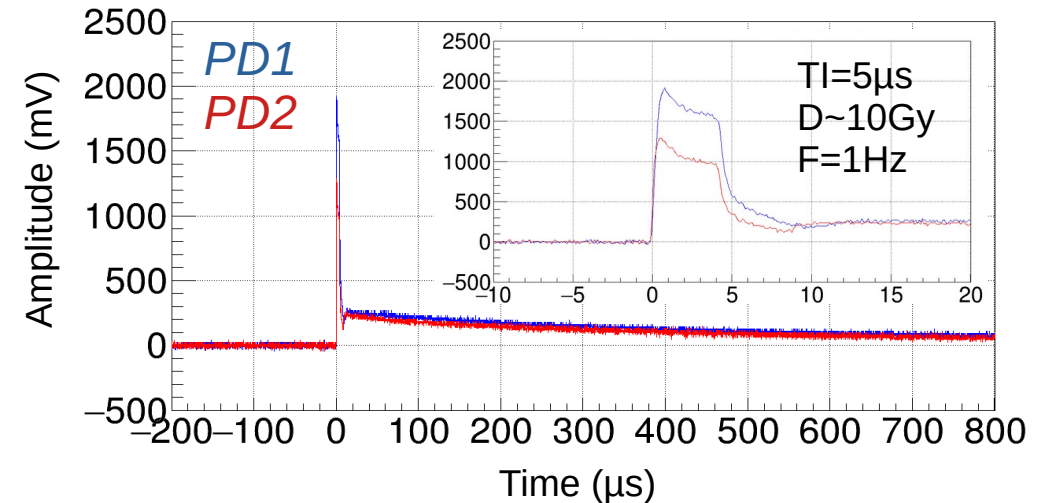

Measurements on FLASH Beam



1) Experience under FLASH Beams

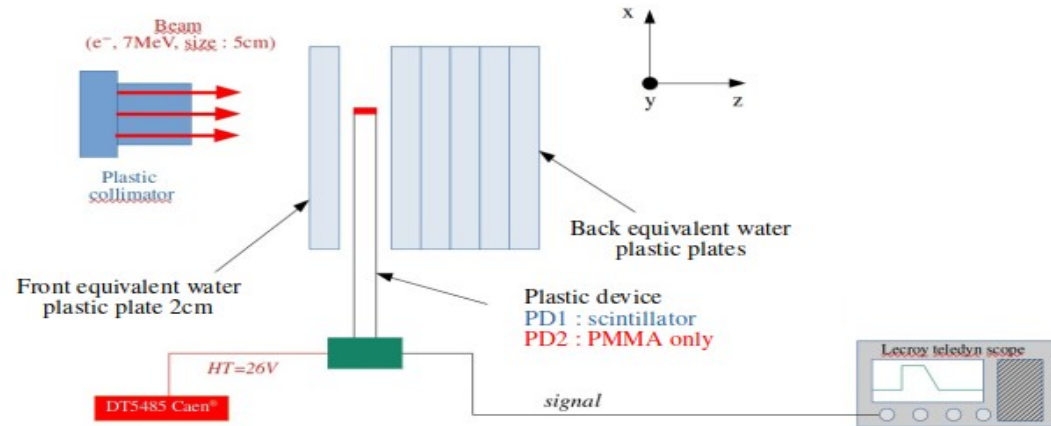

2) Train of pulses (Freq=250Hz, TI=5μs)

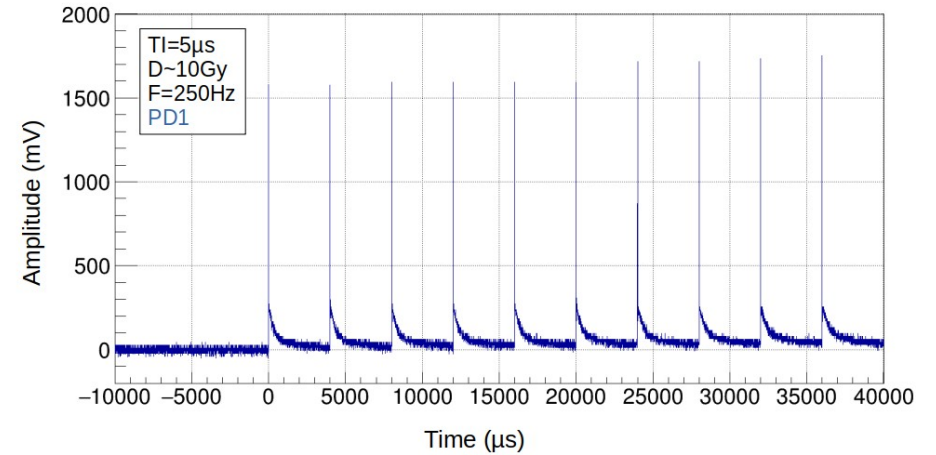

3) Baseline variation

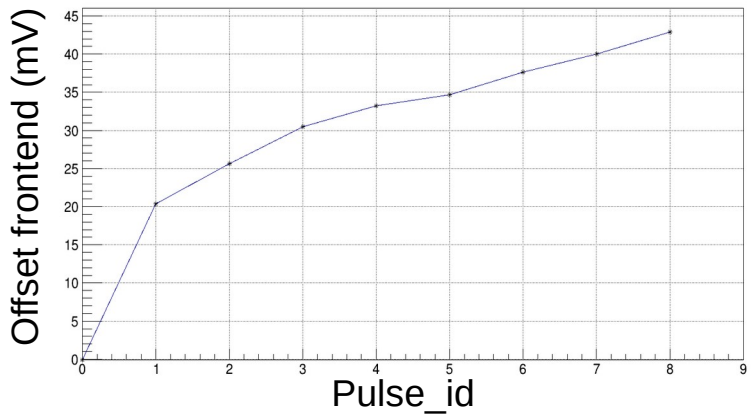

4) Check if saturation effects occur

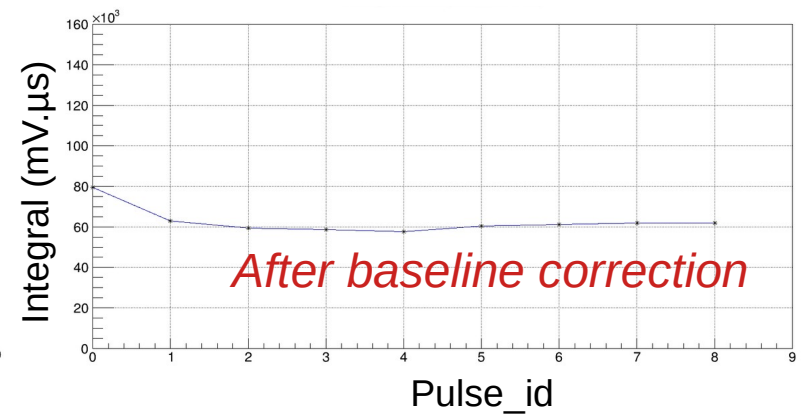
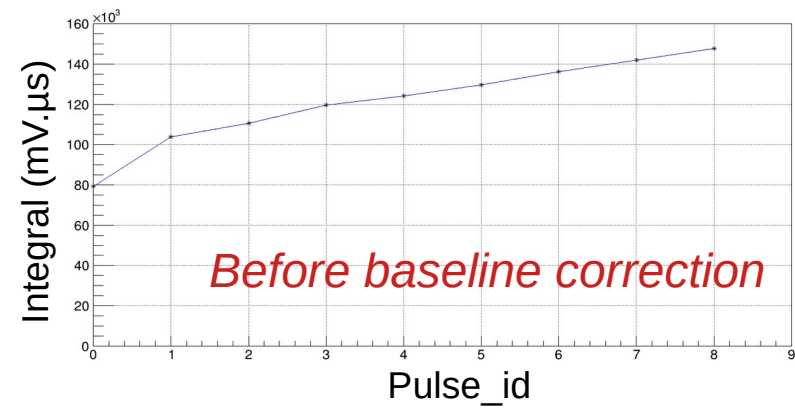



4 ■ Conclusions and future developments

Conclusion and future developments



list



Point dosimeter

- Setup modification
 - scintillator **molding**
- Modification of **chemical formulation**
- Improvement of signal readout
 - using “**fast**” output of SiPMs
 - set-up **shielding**
- Mounting set-up using **PMMA fiber** as wave guide
 - Measurements carried out on **FLASH beams**.

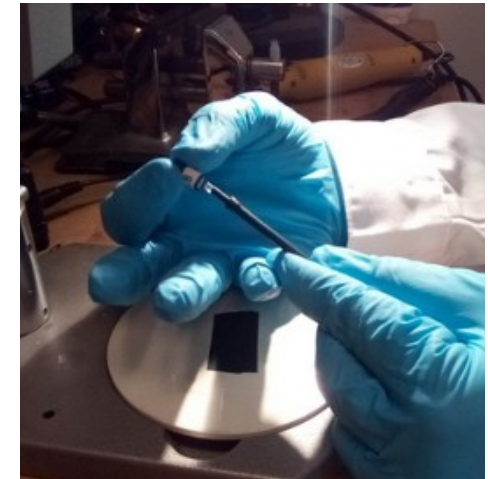
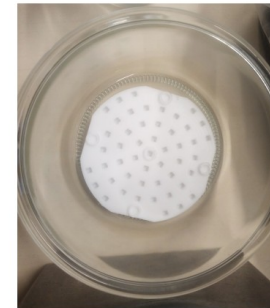
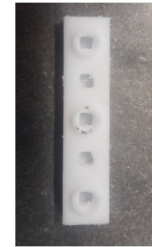

FLASH Beam monitor

- Setup based on fibers “carpet”.



Aknowledgement



M. Agelou, G. H. V. Bertrand, G. Boissonnat, V. Buridon, C. Lynde, J. J. Nahimana, J. Plagnard, D. Tromson



A. Bonfrate, S. Heinrich, S. Kaur, A. L. Patriarca, L. De Marzi

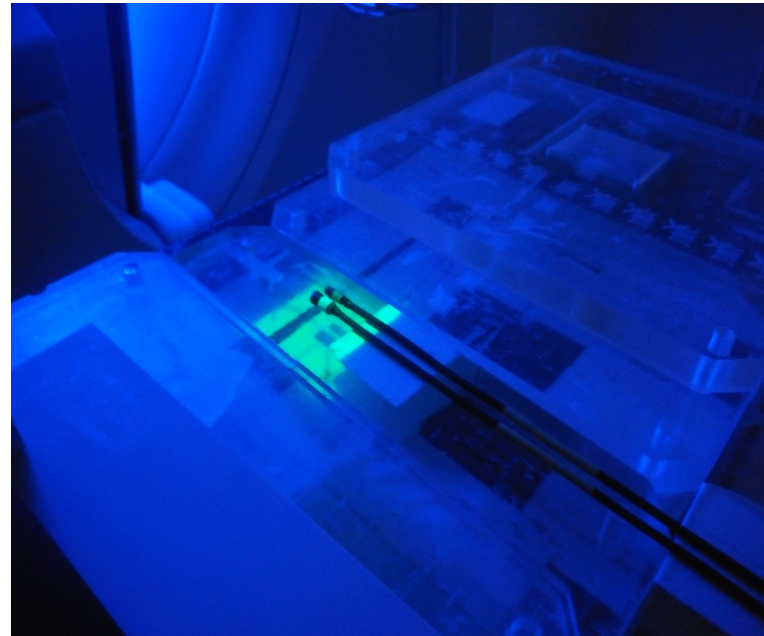
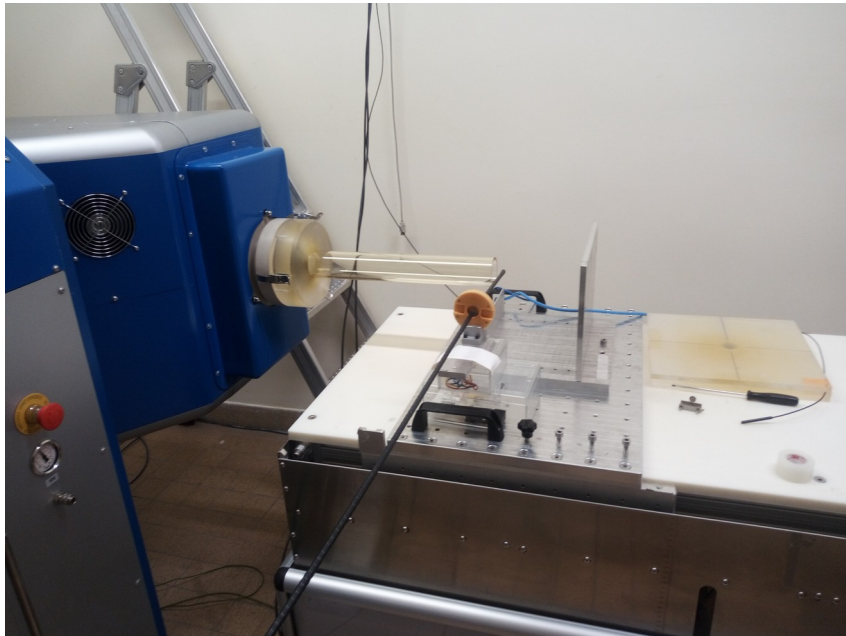



Thank you for your attention