



HAL
open science

Radionuclide-free efficiency calibration of an HPGe detector using monochromatic photon beams measured with a cryogenic radiometer

Victor Hernandez-Elvira, Yves Ménesguen, Marie-Christine Lépy

► **To cite this version:**

Victor Hernandez-Elvira, Yves Ménesguen, Marie-Christine Lépy. Radionuclide-free efficiency calibration of an HPGe detector using monochromatic photon beams measured with a cryogenic radiometer. ICRM 2023 - 23rd International Conference on Radionuclide Metrology and its Applications, Mar 2023, Bucarest, Romania. cea-04258120

HAL Id: cea-04258120

<https://cea.hal.science/cea-04258120>

Submitted on 25 Oct 2023

HAL is a multi-disciplinary open access archive for the deposit and dissemination of scientific research documents, whether they are published or not. The documents may come from teaching and research institutions in France or abroad, or from public or private research centers.

L'archive ouverte pluridisciplinaire **HAL**, est destinée au dépôt et à la diffusion de documents scientifiques de niveau recherche, publiés ou non, émanant des établissements d'enseignement et de recherche français ou étrangers, des laboratoires publics ou privés.



Radionuclide-free efficiency calibration of an HPGe detector using monochromatic photon beams measured with a cryogenic radiometer

Víctor H. Elvira, Yves. Ménesguen, Marie-Christine Lépy

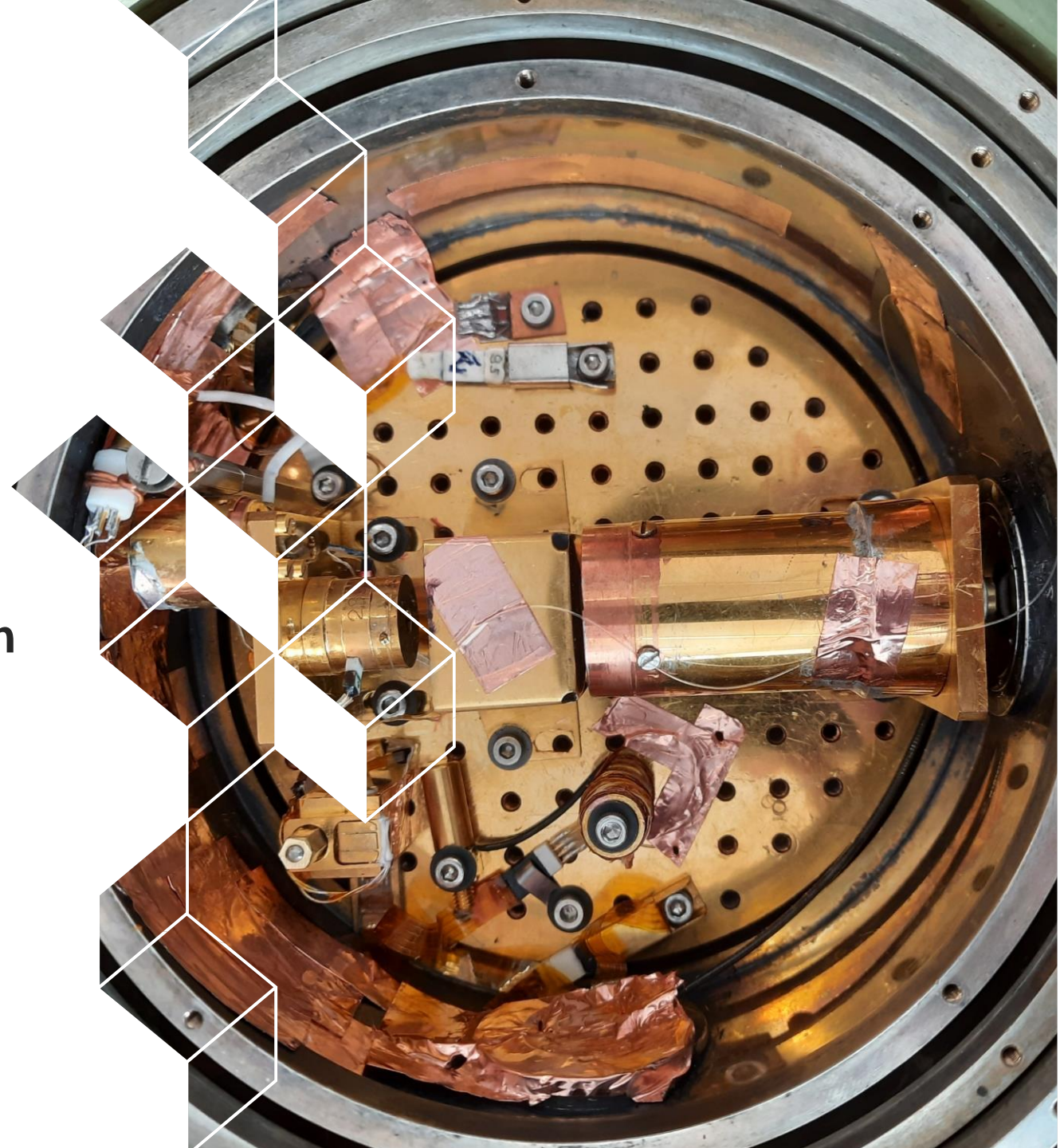

Motivation

Accurate measurement of fundamental parameters, such as X-ray emission intensities, require **well-calibrated spectrometers in terms of efficiency**

In the **conventional approach**, efficiency calibration is carried out by using radionuclides standards, calibrated in activity, and **previously known photon emission probabilities**

$$\varepsilon(E) = \frac{N(E)}{A I(E) t} \prod_i C_i$$

$N(E)$: Net peak area t : counting time (live time) C_i : correction factors
 A : source activity $I(E)$: photon emission intensity

- Photon emission intensities measurements and efficiency calibration strongly linked

Intrinsic limitation: we rely on the same probabilities we intend to measure

- Few radionuclides for calibration

- Correlation between emission intensities

$$I_{XK} = P_\gamma \frac{\alpha_K}{1 + \alpha_T} \omega_K \qquad I_{XK} = P_\varepsilon P_K \omega_K$$

Motivation

- Inconsistency in nuclear data
- E.g. Systematic difference of experimental results using ^{133}Ba (53.2 keV) and ^{241}Am (59.5 keV)

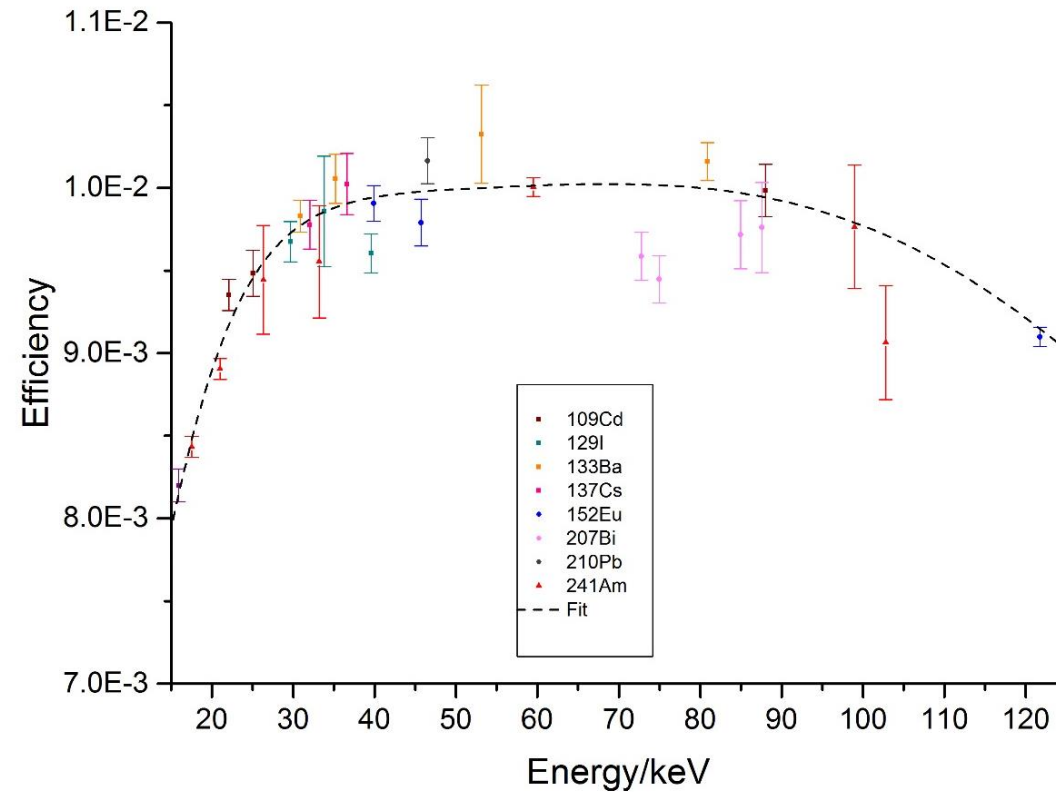

Motivation



SOLUTION

Using well-measured photon fluxes whose calibration is **independent** of any previously measured **fundamental parameter**

This approach requires
ABSOLUTE MEASUREMENT OF PHOTON FLUXES



CRYOGENIC DETECTORS

Cryogenic detectors

When radiation interacts with an absorber, it provokes a **temperature rise**, ΔT , which is proportional to the energy of the incident radiation

pulse mode

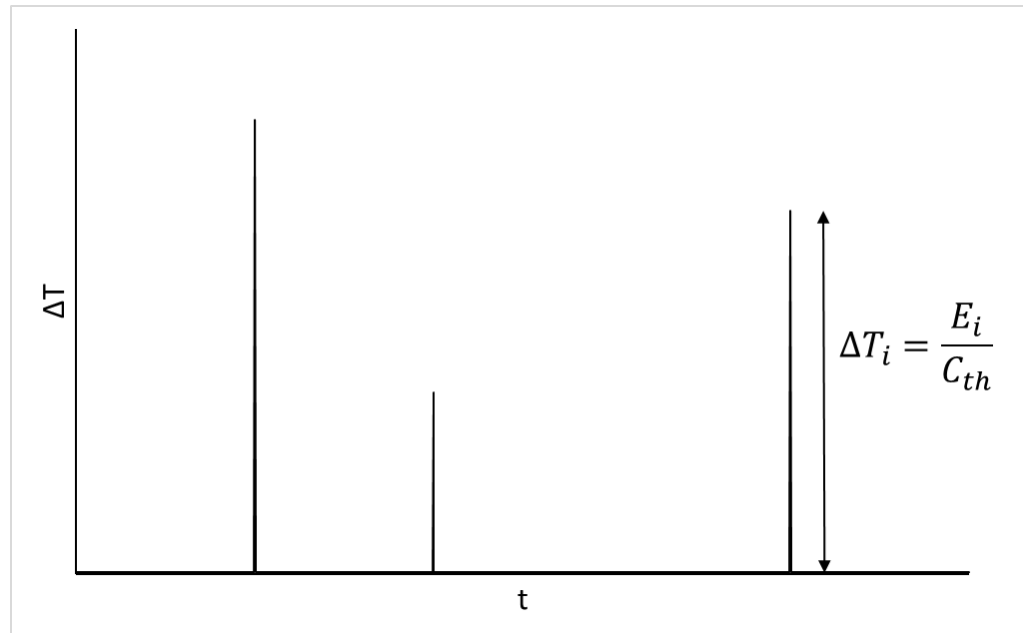

Allows spectroscopy

continuous mode

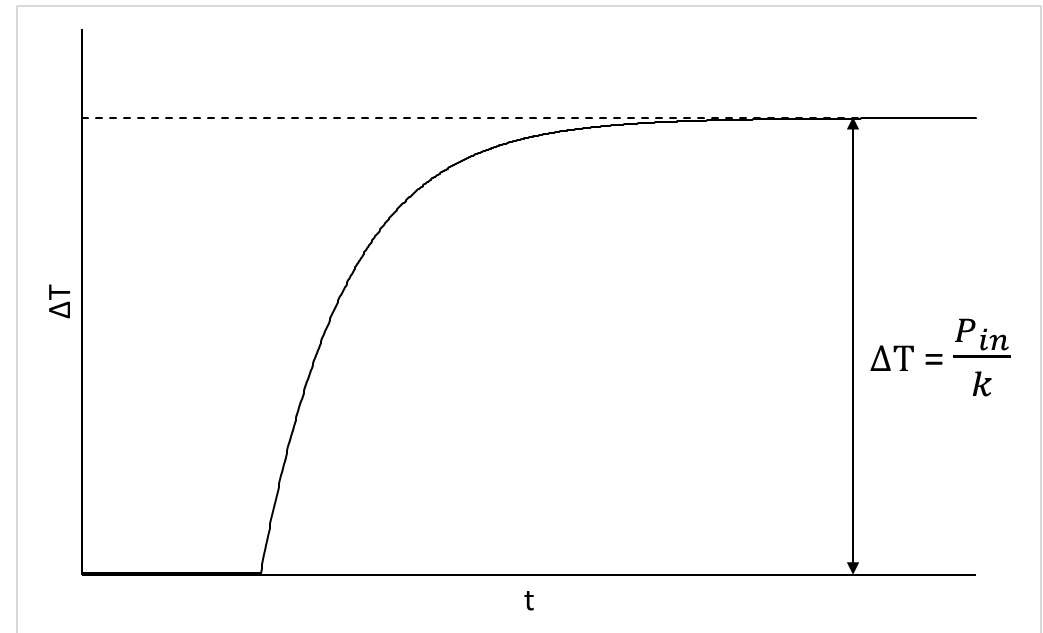

Allows measurement of high photon fluxes

Cryogenic detectors

PRINCIPLE OF ELECTRICAL SUBSTITUTION

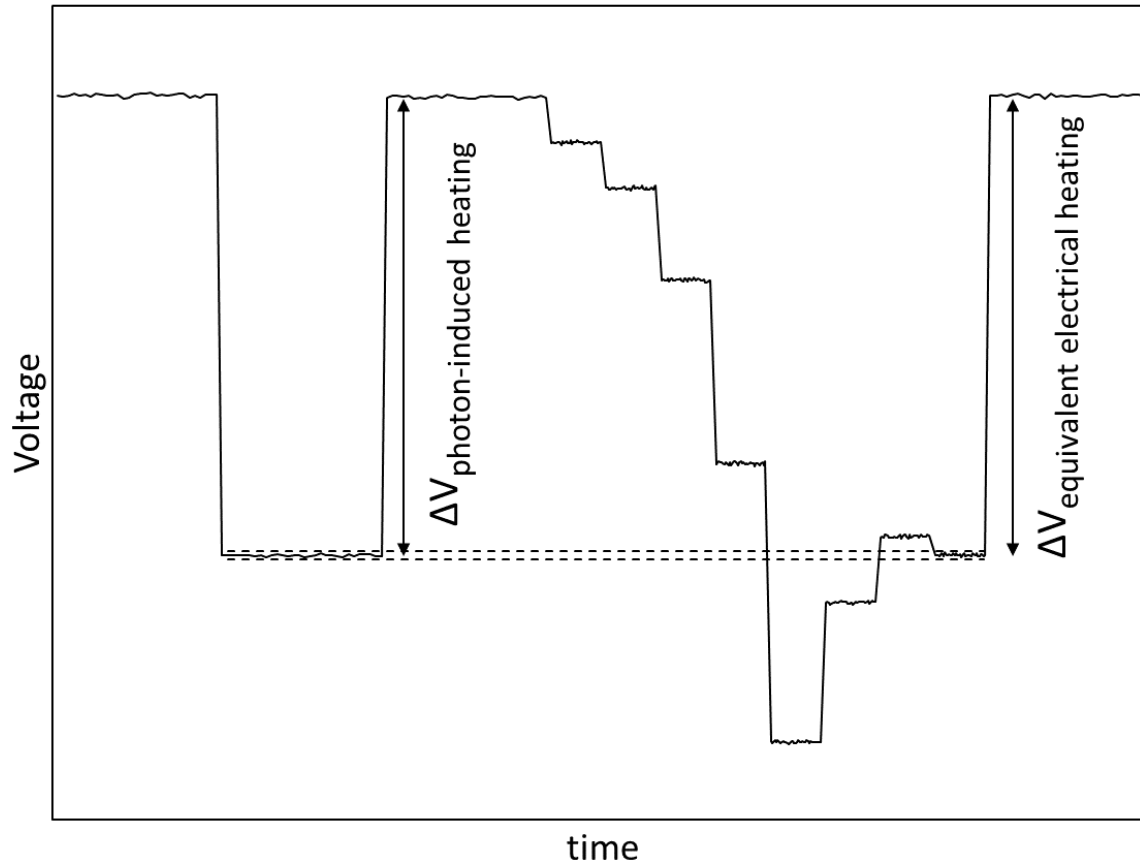

The amount of energy deposited by the radiation can be known by finding the **electrical power** that needs to be transferred to the absorber in order to obtain **the same temperature rise**

$$\eta P_{\text{rad}} = IR^2$$

A **thermistor** linked to the absorber is polarized with a constant current so that the **decrease in resistance** provoked by the **temperature rise** causes a **decrease in tension**

BOLUX - BOLometer for Use in the range of X-rays

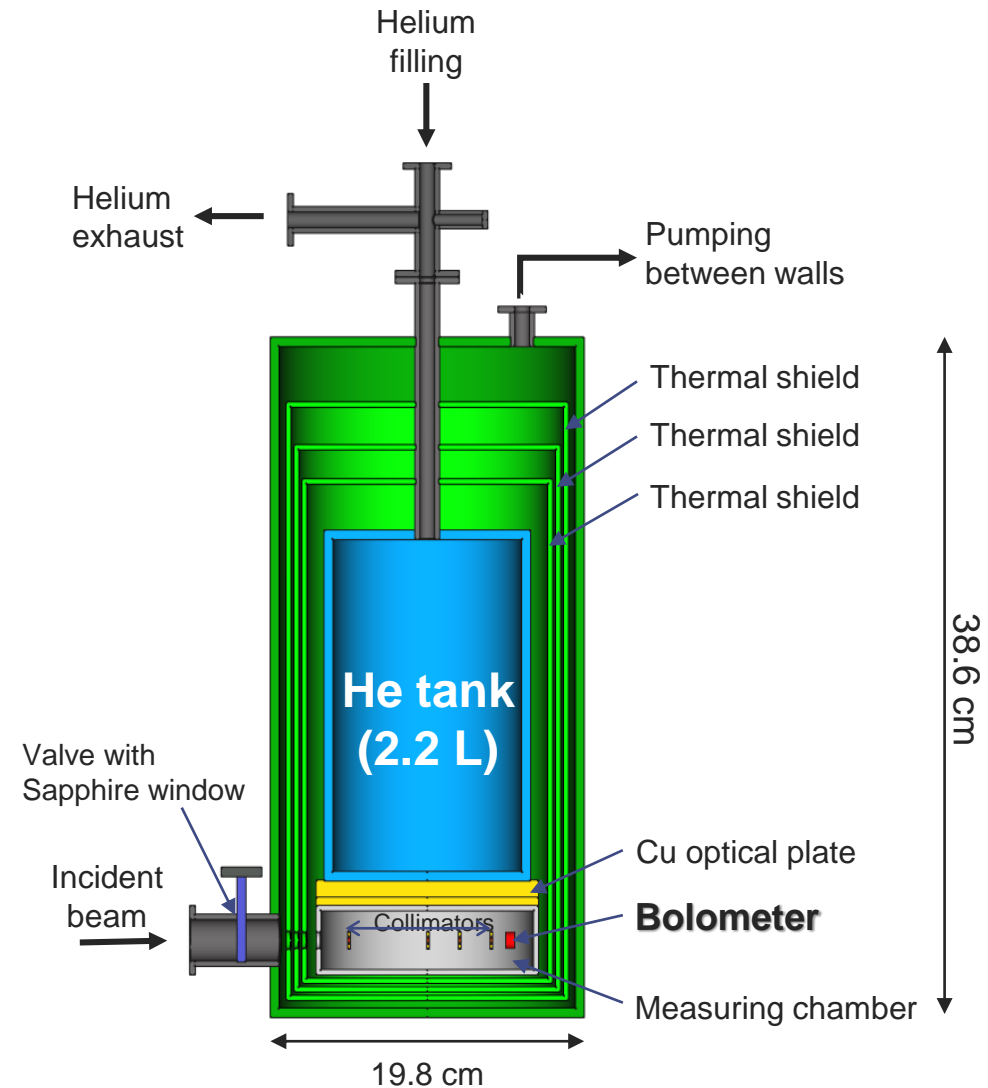
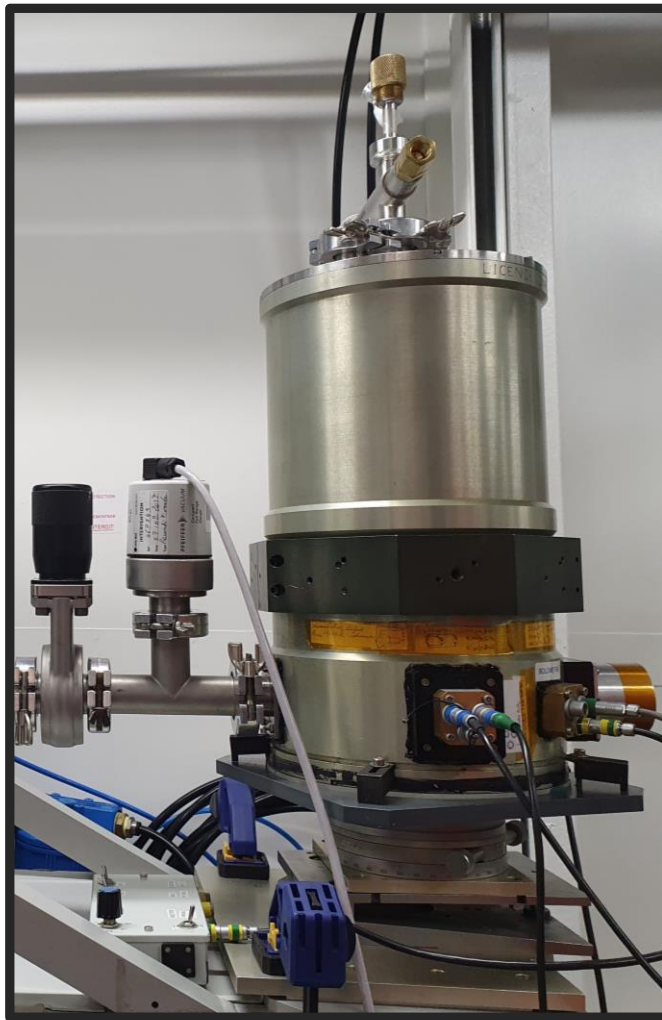

BOLUX - BOLometer for Use in the range of X-rays

Cryostat

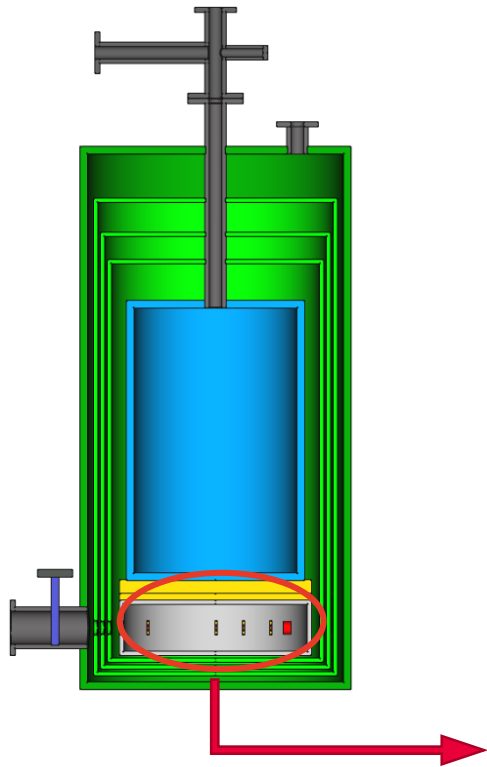

Measuring chamber

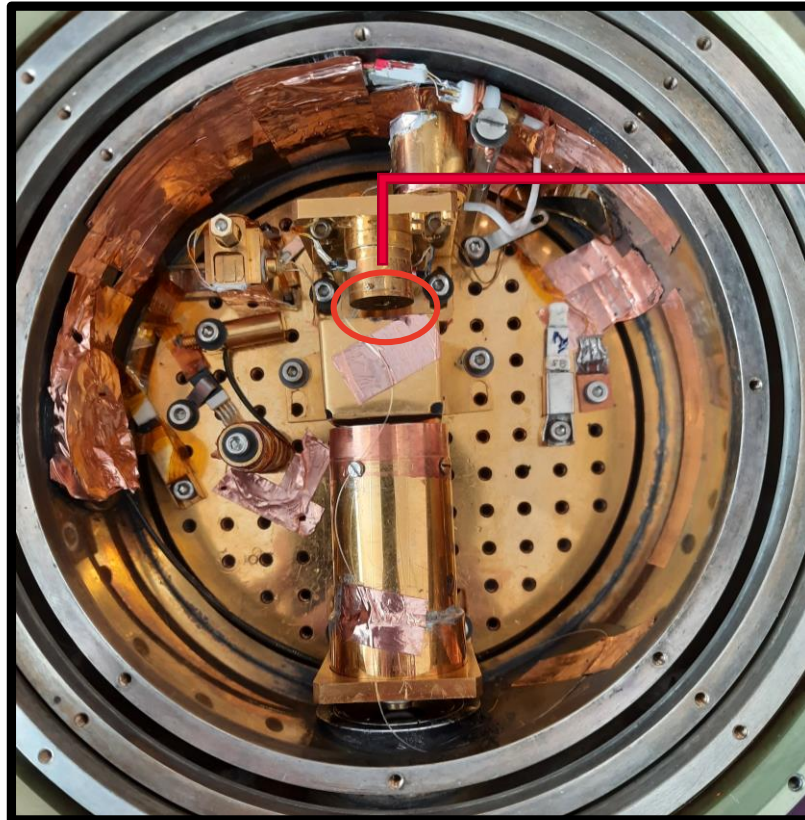

Bolometer

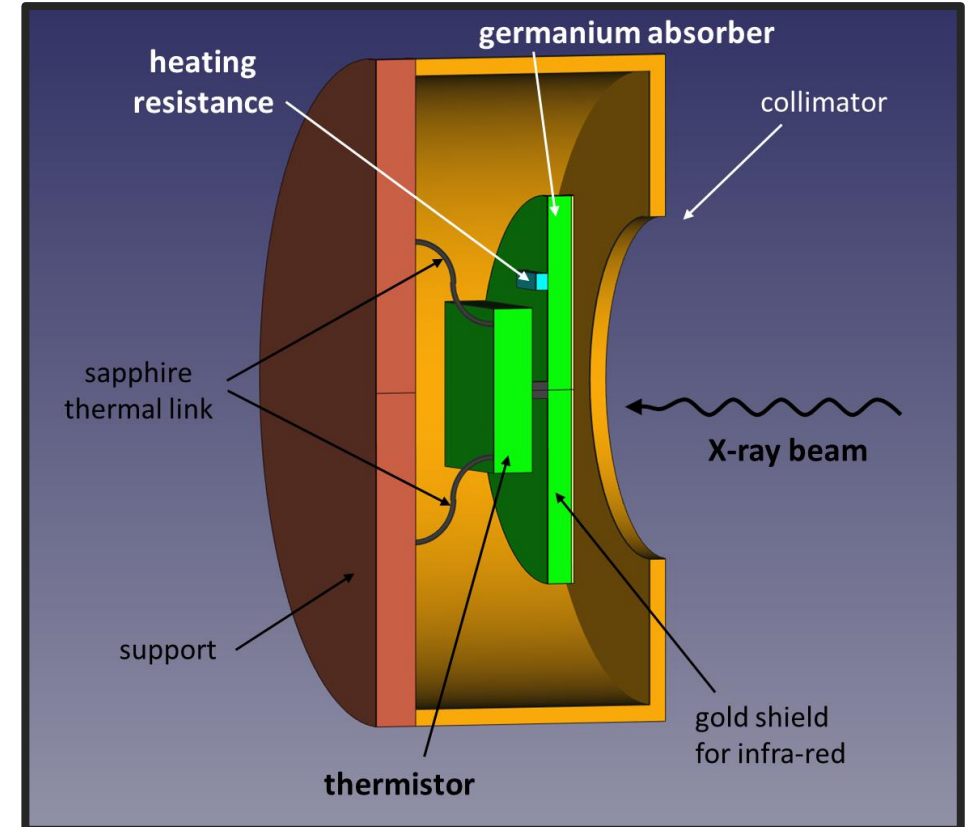

Measurements

1st step, with a high photon flux ($\sim 10^9$ ph/s)

BOLUX
Measurement of the beam power

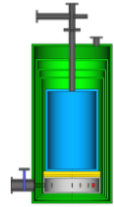

+

Photodiode
Measurement of the current induced

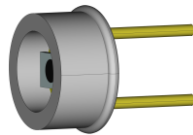

Efficiency of the photodiode
Eff

$$\frac{\text{Current (A)}}{\text{Beam Power (W)}}$$

The efficiency of both BOLUX and the photodiode depend on the **photon's energy**

but neither of them are able to discriminate photons by energy



Monochromatic radiation



2nd step, with a much lower photon flux ($\sim 10^3$ ph/s)

Photodiode
Measurement of the number of emitted photons per second

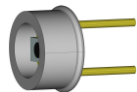

+

$$\frac{\text{Current}}{\text{Eff} \cdot E_{\text{photon}}}$$

Semiconductor detector
Measurement of count rate

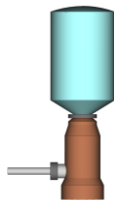

Efficiency of the semiconductor detector

$$\frac{\text{Count rate}}{\text{Emitted photons/second}}$$

Measurements

Preliminary: calculation of the correction factor for BOLUX

Average energy deposited in the absorber per incident photon

Below 100 % due to

- ☐ Photons that do not interact with the absorber (transmission)
- ☐ Photons that do interact but do not deposit all of their energy
 - Characteristic X-ray escape
 - Scattering

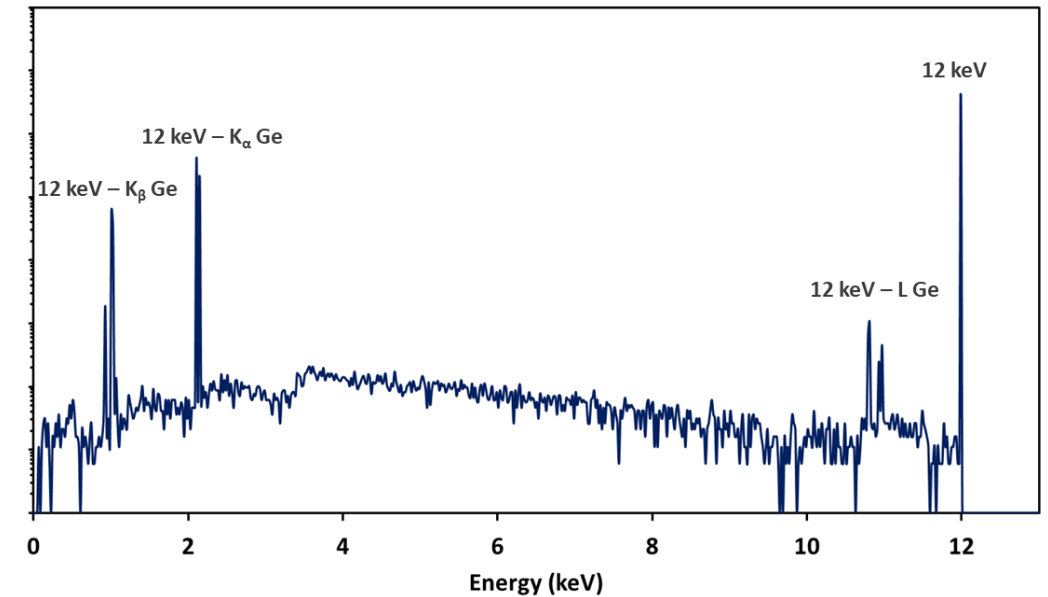
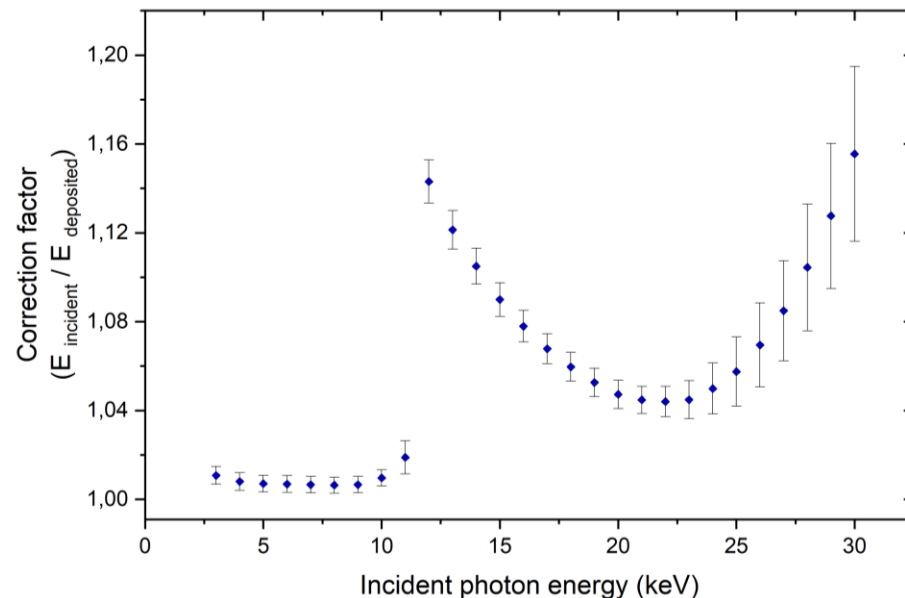

Monte Carlo simulations

PENELOPE

PENetration and ENergy LOss of P positrons and E lectrons †

† F. Salvat, OECD/NEA Data Bank (2015)

Measurements

Preliminary: optimization of the beam – study of harmonics

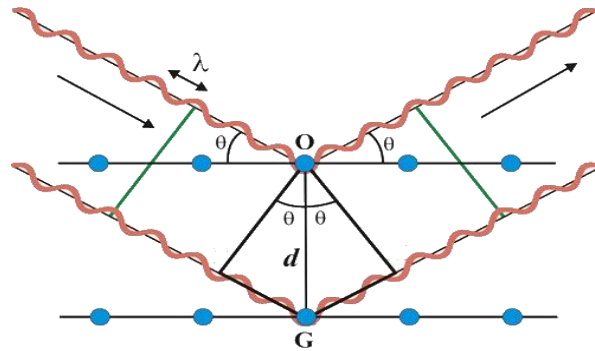

$$2d \sin \theta_B = n\lambda$$

Detuning (pitch) of the second crystal to suppress **higher-order harmonics**

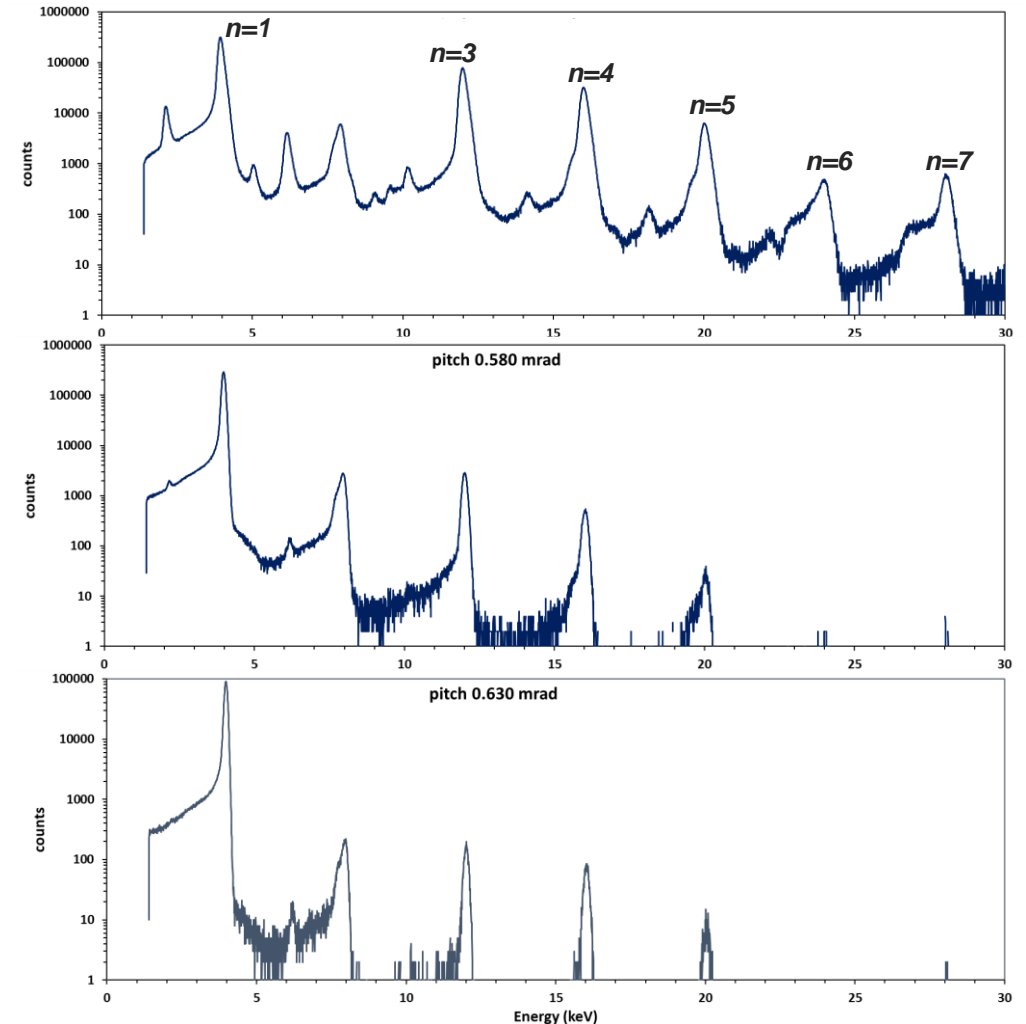
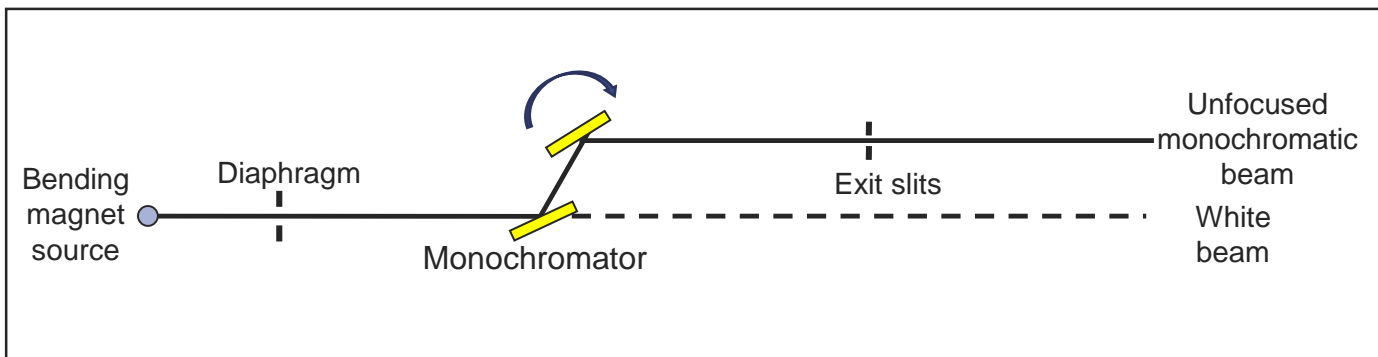

Measurements

Calibration of a HPGe

Results for 3.5 keV – 8 keV

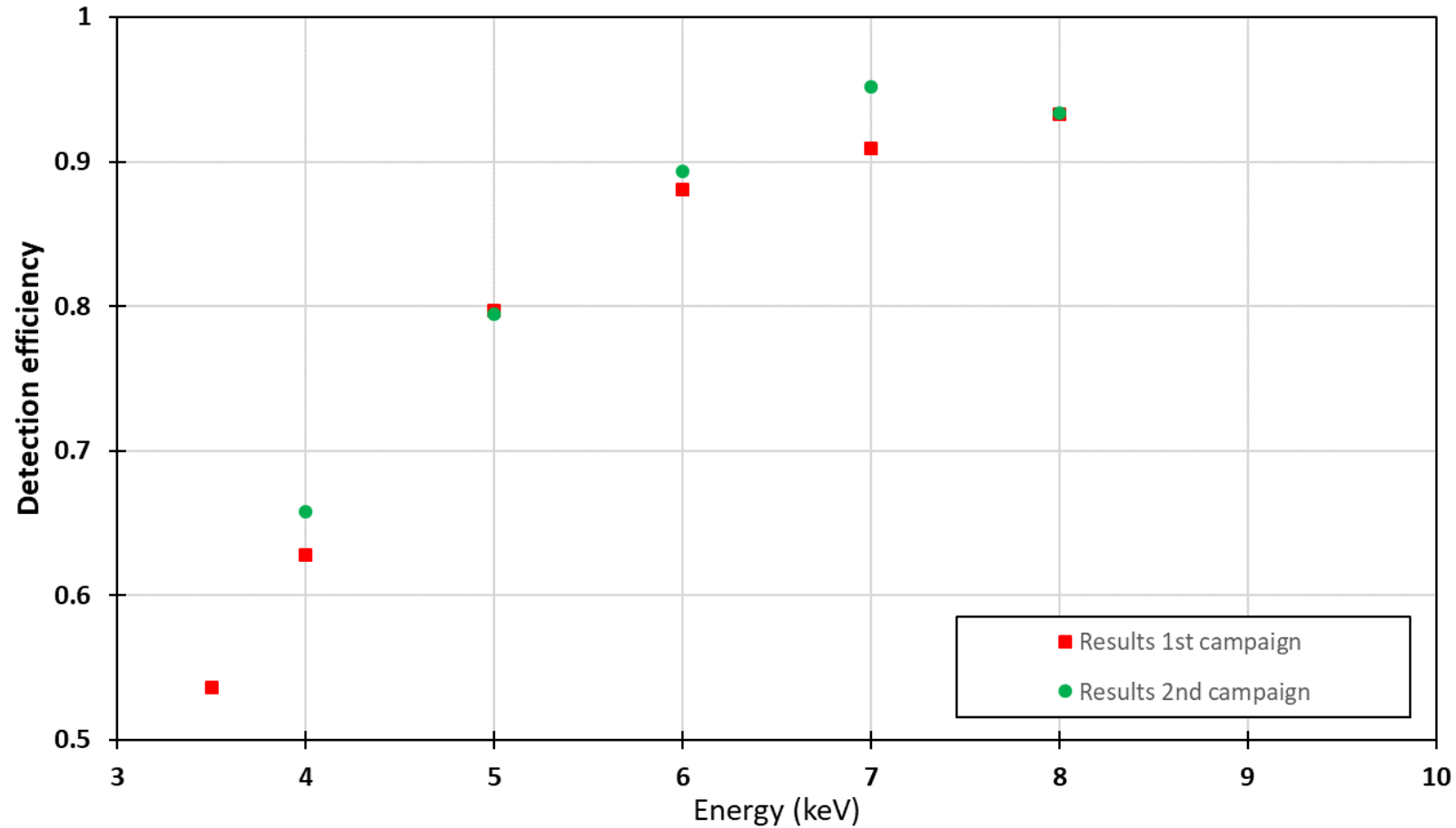

Measurements

Calibration of a HPGe

Optimization of the dead layer

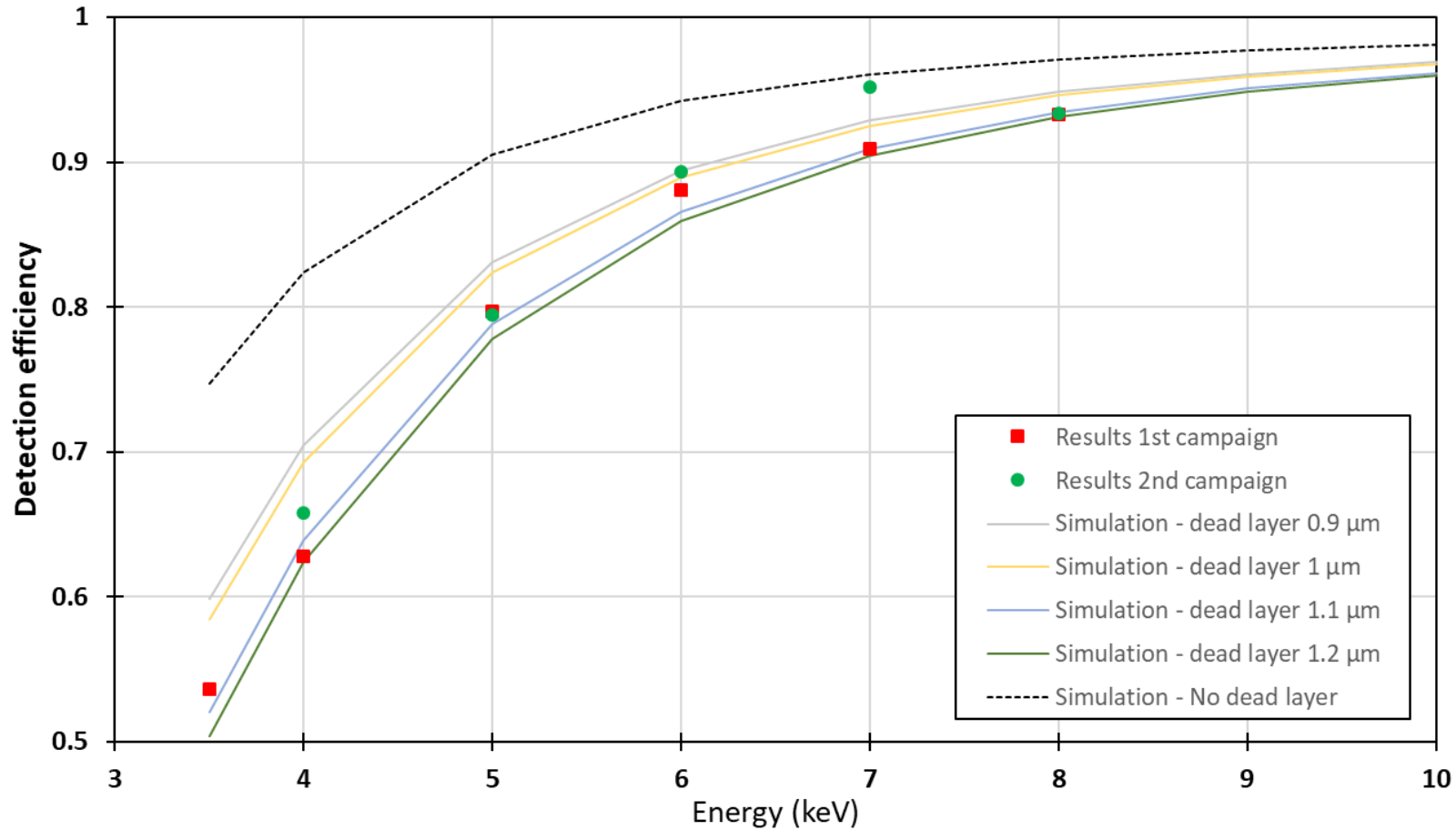

Exploiting experimental results

Extension of the energy interval
via Monte Carlo simulations

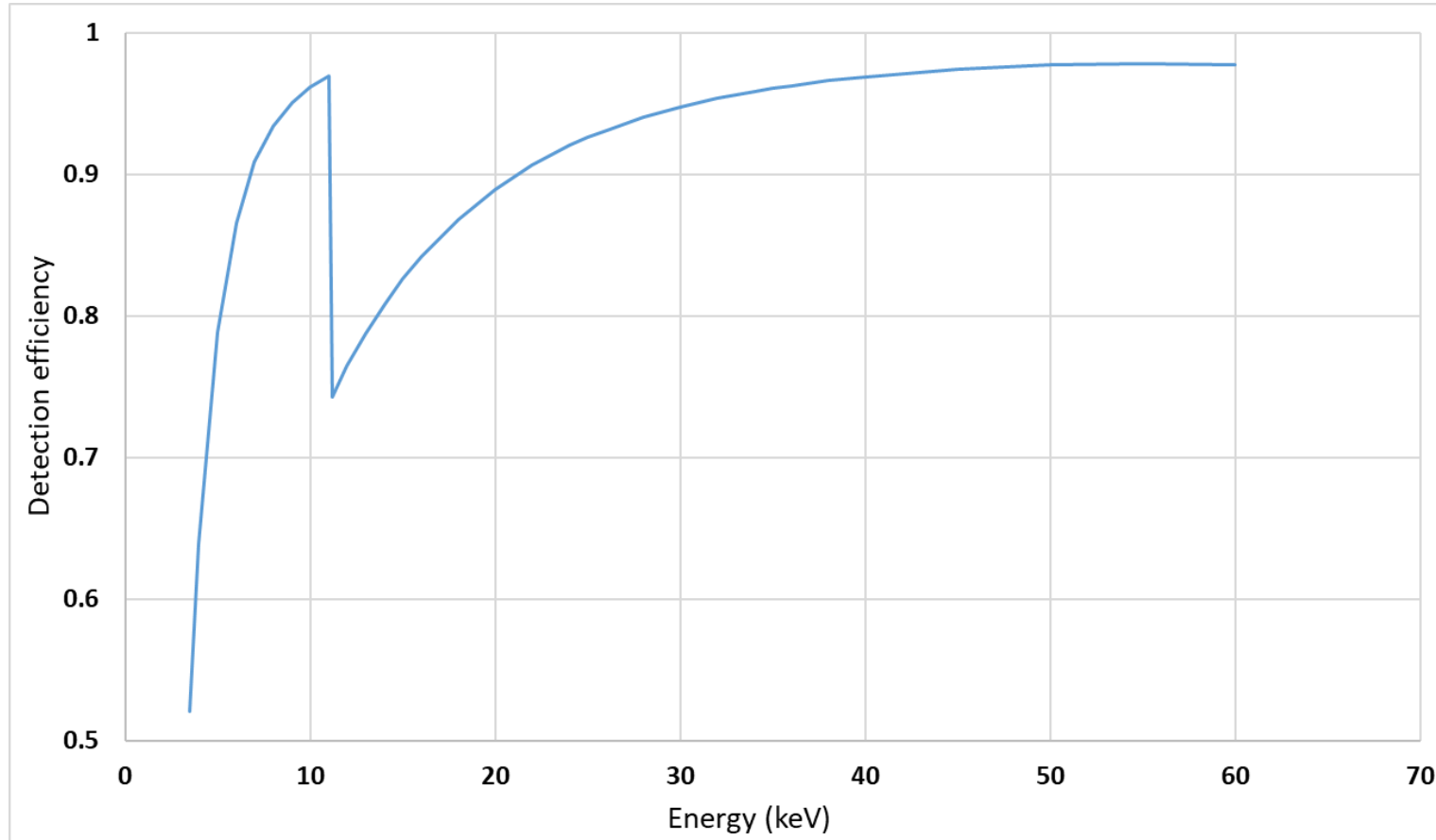

Exploiting experimental results

Extension of the energy interval via Monte Carlo simulations

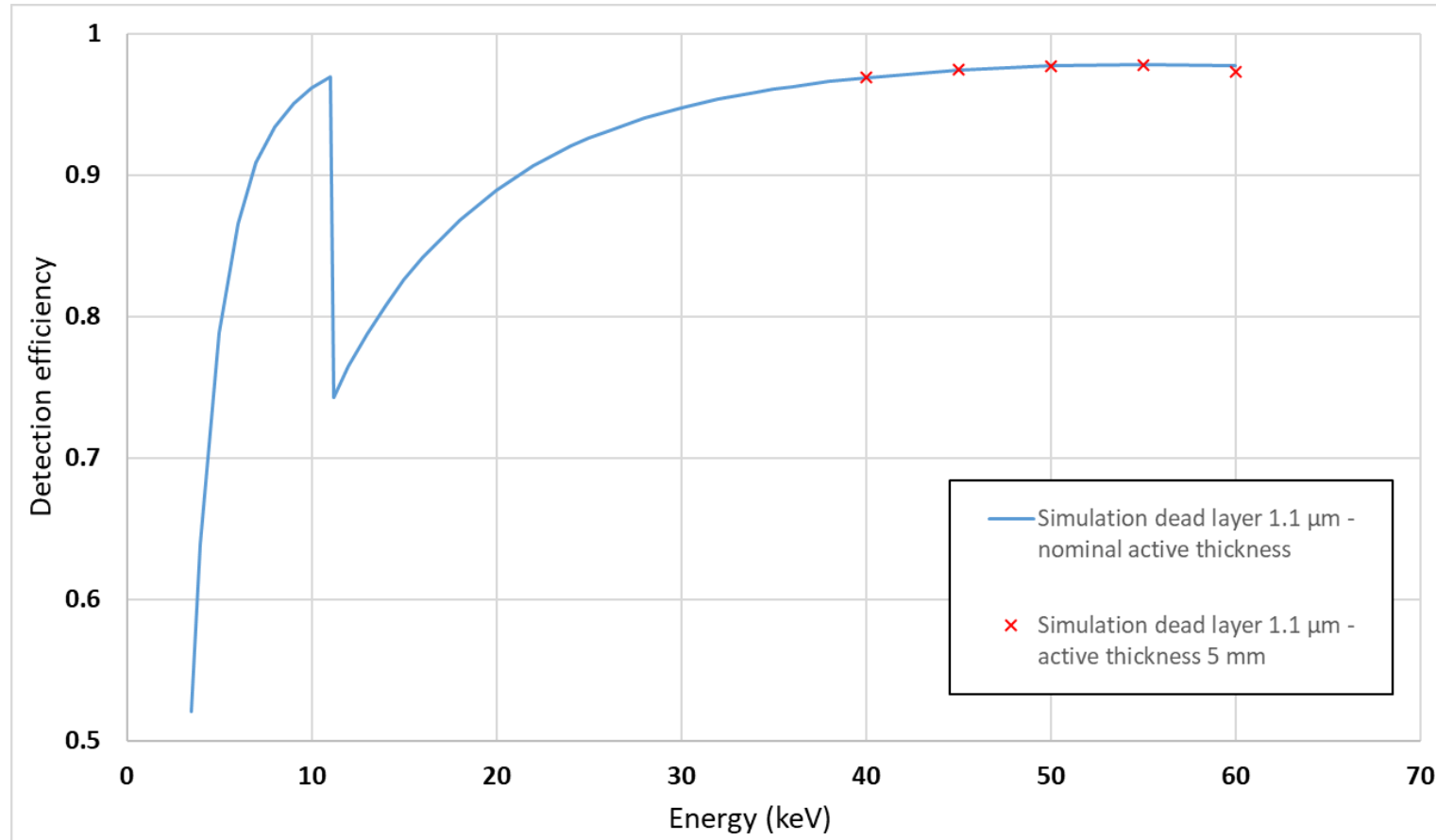

Exploiting experimental results

Extension of the energy interval via Monte Carlo simulations

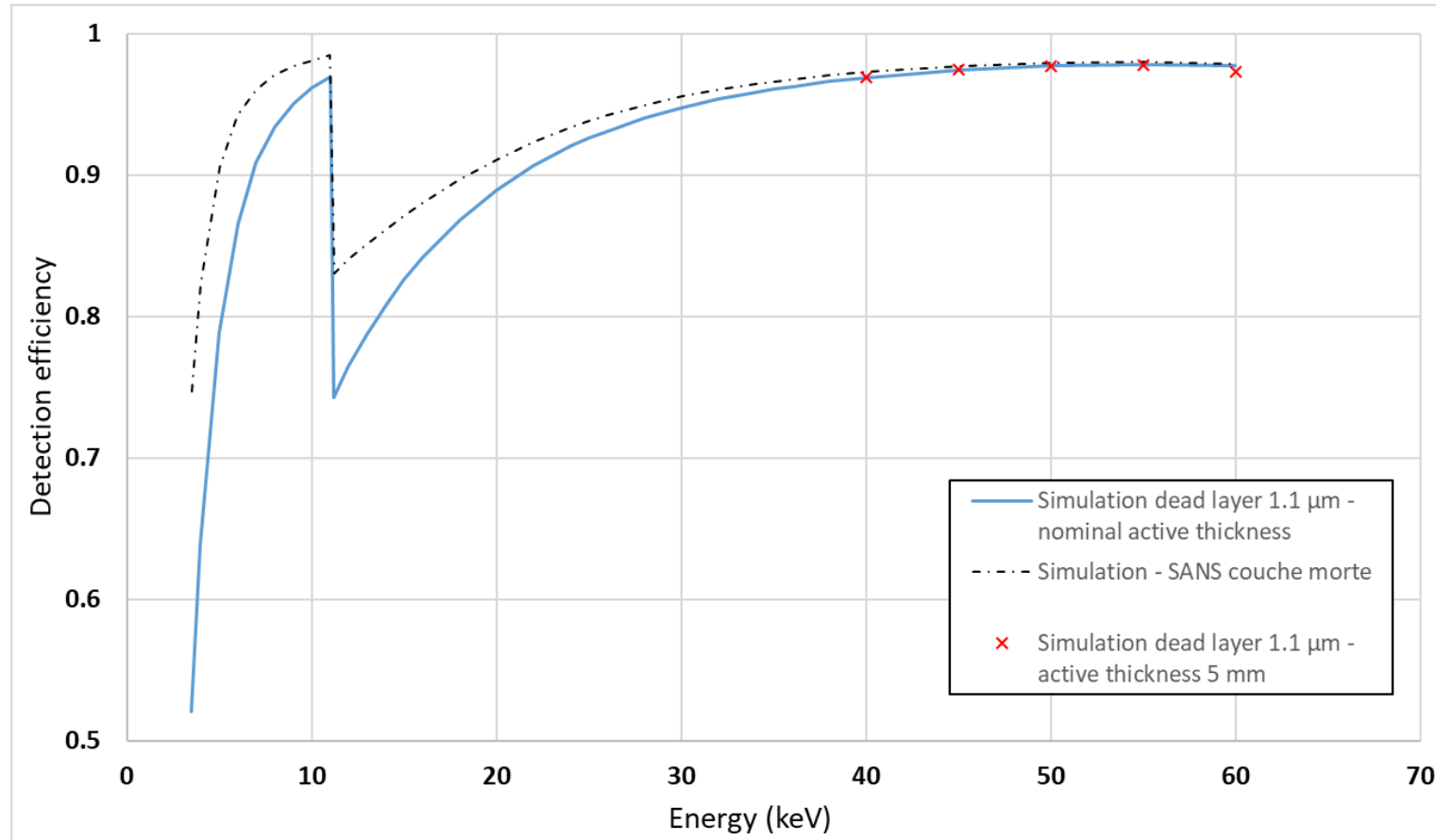

Exploiting experimental results

Determination of geometric efficiency

$$\varepsilon(E) = \varepsilon_{intr}(E) \cdot \varepsilon_{geom} = \varepsilon_{intr}(E) \cdot \Omega/4\pi$$

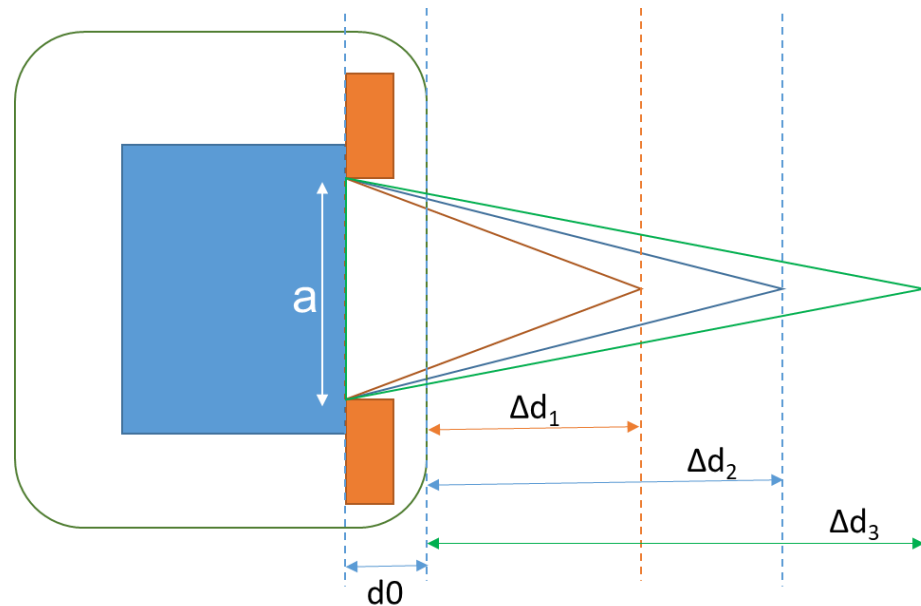

$$r = r_{4\pi} 0.5 \left(1 - \frac{(d_0 + \Delta d)}{\sqrt{(d_0 + \Delta d)^2 + a^2}} \right)$$

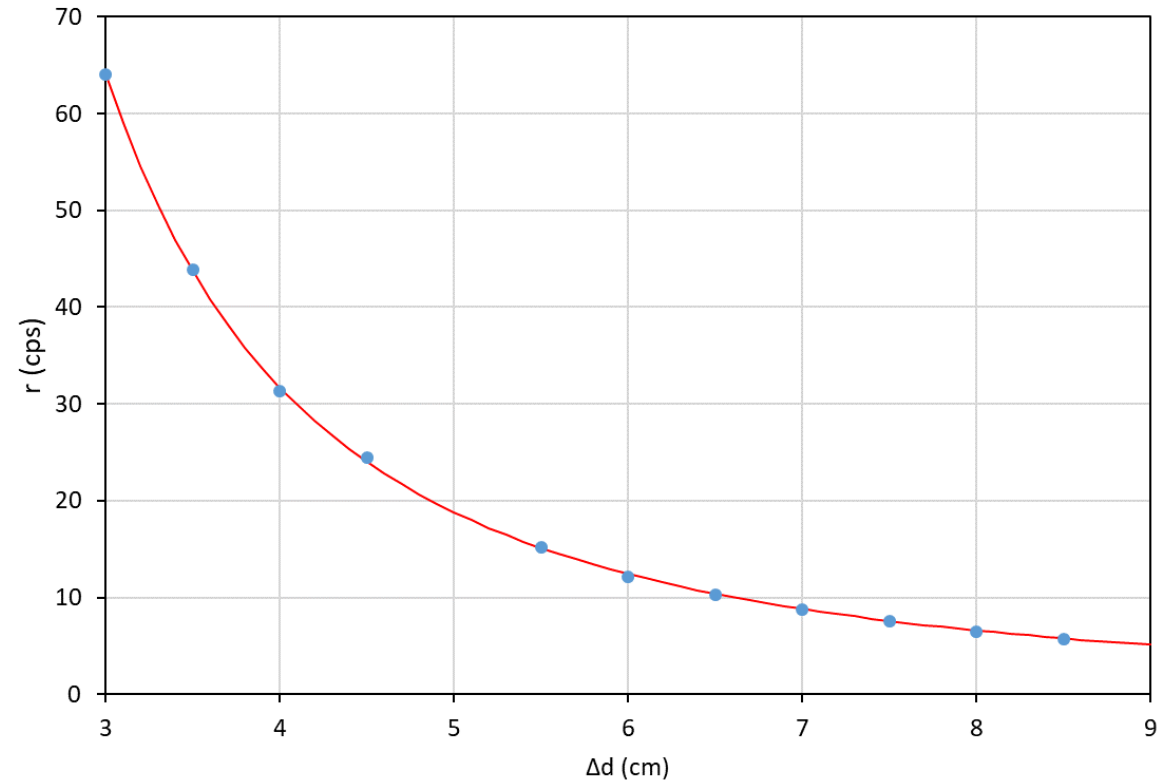

Measurement of ^{133}Ba k_α count rate of the same source at variable distance

Application to the determination of photon emission intensities

Preliminary measurements of I_γ 53 keV of ^{133}Ba

I_γ (53 keV) ^{133}Ba	
DDEP 2004	2.14 (3)
DDEP 2016	2.14 (6)
This work	2.25
Lépy et al. (2018) *	2.229 (23)

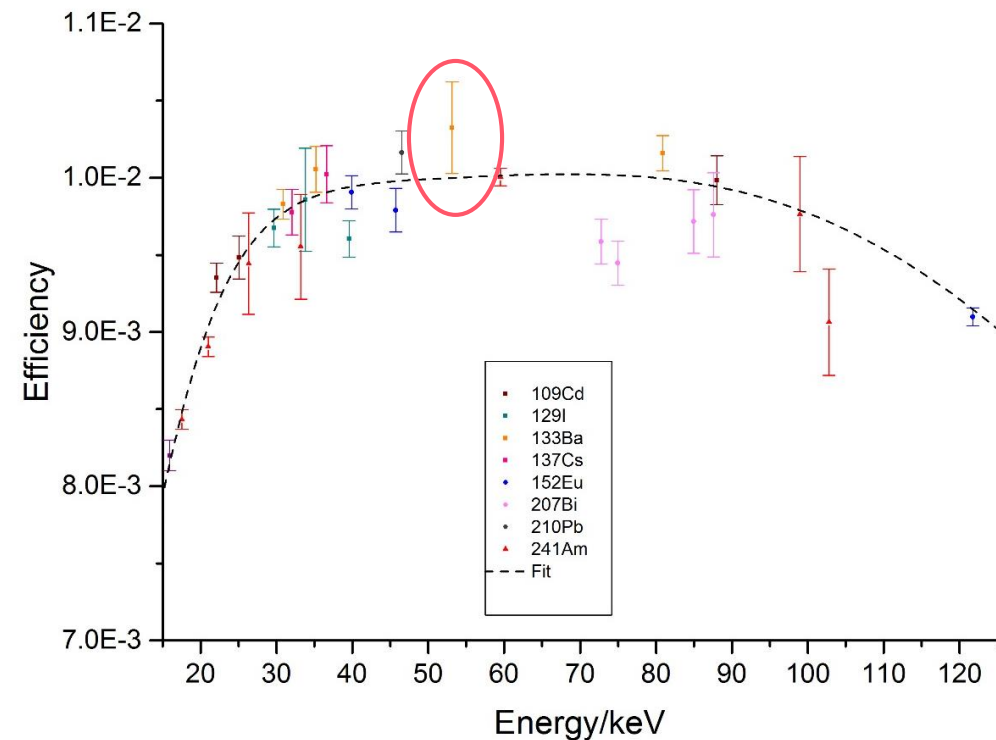

* M.-C. Lépy, L. Brondeau, Y. Ménesguen, S. Pierre, J. Riffaud
Appl. Radiat. Isot., 134 (2018), pp. 131-136

Conclusions

Successfully accomplished

- Set-up and restart of cryogenic detector *BOLUX*
- Absolute measurement of synchrotron photon flux intensities
- Determination of the intrinsic efficiency of a HPGe in the energy range where the thickness of the dead layer is critical
- Extrapolation of the efficiency curve via Monte Carlo simulations to the whole energy range where the active thickness is not critical (3 - 55 keV)
- Determination of the geometric efficiency through the measurement of the same source at variable distances
- Preliminary measurement of ^{133}Ba γ -emission intensity at 53 keV. Promising results

In progress – future work

- Geometrical characterization of the HPGe for the accurate determination of the geometric efficiency
- Refinement of measurement of ^{133}Ba γ -emission intensity at 53 keV
and extension to other photon emission intensities of radionuclides of interest: $^{93\text{m}}\text{Nb}$, ^{152}Eu , $^{103\text{m}}\text{Rh}$...

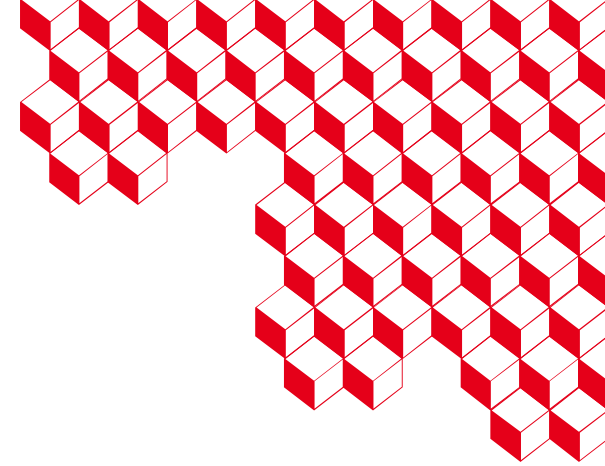

Thank you for your attention!

Mușumesc foarte mult!

Merci beaucoup !

¡Muchas gracias!

*We gratefully acknowledge
Synchrotron SOLEIL and the
team of Métrologie Beamline!*

Víctor H. Elvira, Yves Ménesguen, Marie-Christine Lépy

victor.hernandez-elvira@cea.fr

Testing solid angle fit

According to the **activity of the source**, and taking emission **intensities from bibliography** and correcting for the intrinsic efficiency of the detector, the expected emission rate of $k\alpha$ in 4π would be **9908.6 cps**

We measured $k\alpha$ count rate at a fixed position and calculated the emission rate in 4π relying on the solid angle obtained from the fit with **$a = 4$ mm** and correcting for intrinsic efficiency. This leads to **9309 cps** in 4π

We try several fits at different a fixed. The one that predicts the expected value the best is $a = 3.88$ mm

Model	GOUDURIX (User)
Equation	$A*(1-1/\sqrt{1+(4/(B+x))^2})$
Plot	ka TOT corr att et decay
A	$4422,30761 \pm 53,39771$
B	$-6,76712 \pm 0,1653$
Reduced Chi-Sqr	0,05315
R-Square (COD)	0,99986
Adj. R-Square	0,99985

Nominal radius

Model	GOUDURIX (User)
Equation	$A*(1-1/\sqrt{1+(R/(B+x))^2})$
Plot	ka TOT corr att et decay
A	$4536,27086 \pm 54,80089$
B	$-6,75746 \pm 0,16536$
R	$3,95 \pm 0$
Reduced Chi-Sqr	0,05323
R-Square (COD)	0,99986
Adj. R-Square	0,99985

Model	GOUDURIX (User)
Equation	$A*(1-1/\sqrt{1+(R/(B+x))^2})$
Plot	ka TOT corr att et decay
A	$4654,62532 \pm 56,32543$
B	$13,25201 \pm 0,16593$
R	$3,9 \pm 0$
Reduced Chi-Sqr	0,05332
R-Square (COD)	0,99986
Adj. R-Square	0,99985

Model	GOUDURIX (User)
Equation	$A*(1-1/\sqrt{1+(R/(B+x))^2})$
Plot	ka TOT corr att et decay
A	$4777,66041 \pm 57,774$
B	$-6,73852 \pm 0,1655$
R	$3,85 \pm 0$
Reduced Chi-Sqr	0,0534
R-Square (COD)	0,99986
Adj. R-Square	0,99985

Model	GOUDURIX (User)
Equation	$A*(1-1/\sqrt{1+(R/(B+x))^2})$
Plot	ka TOT corr att et decay
A	$4905,54208 \pm 59,42067$
B	$13,2707 \pm 0,16607$
R	$3,8 \pm 0$
Reduced Chi-Sqr	0,05348
R-Square (COD)	0,99986
Adj. R-Square	0,99985

a	$r_{4\pi}$	$r_{4\pi} / \epsilon_{intr}$
4	8844	9309
3.95	9072	9549
3.9	9308	9798
3.88	9406	9901
3.87	9456	9954
3.85	9556	10059
3.80	9810	10326

Accurate value of a , to be confirmed by characterization by X-ray imaging

Measurements

Calibration of a Silicon-Drift Detector

