



**HAL**  
open science

## Towards a radon-in-water primary standard at LNHB

Krasimir Mitev, Benoit Sabot, Sylvie Pierre, Marie-Christine Lepy, Philippe  
Cassette

► **To cite this version:**

Krasimir Mitev, Benoit Sabot, Sylvie Pierre, Marie-Christine Lepy, Philippe Cassette. Towards a radon-in-water primary standard at LNHB. *Applied Radiation and Isotopes*, 2023, 201, pp.111013. 10.1016/j.apradiso.2023.111013 . cea-04243974

**HAL Id: cea-04243974**

**<https://cea.hal.science/cea-04243974v1>**

Submitted on 16 Oct 2023

**HAL** is a multi-disciplinary open access archive for the deposit and dissemination of scientific research documents, whether they are published or not. The documents may come from teaching and research institutions in France or abroad, or from public or private research centers.

L'archive ouverte pluridisciplinaire **HAL**, est destinée au dépôt et à la diffusion de documents scientifiques de niveau recherche, publiés ou non, émanant des établissements d'enseignement et de recherche français ou étrangers, des laboratoires publics ou privés.



# Towards a Radon-in-water primary standard at LNHB

K. Mitev<sup>a</sup>, B. Sabot<sup>b</sup>, S. Pierre<sup>b</sup>, M-C Lépy<sup>b</sup>, P. Cassette<sup>a</sup>

- a) Sofia University "St. Kliment Ohridski", Faculty of Physics, Bulgaria
- b) Université Paris-Saclay, CEA, LIST, Laboratoire National Henri Becquerel (LNE-LNHB), F-91120 Palaiseau, France.

# What is the ChatGPT opinion?



What is the primary radon-in-water standard in metrology context?

In the metrology context, the primary radon-in-water standard refers to a certified reference material (CRM) that contains a known concentration of radon in water, which is used to calibrate radon measurement instruments and establish traceability to national or international standards.



The concentration of radon in the primary radon-in-water standard is typically expressed in becquerels per liter (Bq/L) or picocuries per liter (pCi/L) and is traceable to the International System of Units (SI) through recognized metrological procedures.

National metrology institutes (NMIs) such as the National Institute of Standards and Technology (NIST) in the United States maintain primary radon-in-water standards to ensure the accuracy and traceability of radon measurements in water. These standards are used to calibrate secondary radon measurement standards and devices used by radon measurement laboratories and other organizations.

The primary radon-in-water standard is a critical component of ensuring the accuracy of radon measurements in water, which is important for protecting public health. High levels of radon in drinking water can increase the risk of certain types of cancer, and accurate measurements are necessary to determine the appropriate mitigation strategies to reduce exposure.



So, everything seems to be OK?

01

Despite the wide scale applicability of Radon-in-water measurements, to the best of our knowledge, currently there is no “pure” radon-in-water standard;

02

The three most widely used methods for radon in water are emanometry, gamma-spectrometry and liquid scintillation counting;

03

They use different calibration strategies in order to evaluate  $^{222}\text{Rn}$  concentration in the water.

01

In most of the gamma-spectrometry  $^{222}\text{Rn}$  measurements, the radon activity is evaluated from the activity of its short lived progenies ( $^{214}\text{Pb}$ ,  $^{214}\text{Bi}$ ).



It should be emphasized that radon progeny in water may behave differently than radon and may introduce inhomogeneities (e.g. wall deposition). Hence there might be differences between the calibration and measurement conditions, which is a potential source of bias (especially in close measurement geometries).



02

In the liquid scintillation counting the calibration standards are based on  $^{226}\text{Ra}$  standards.



However, some of the LSC methods are known to be prone to interference when using  $^{226}\text{Ra}$  standards. This is due to the accumulation of long-lived radon progeny (mainly  $^{210}\text{Po}$ ), if the sources were not purified.

L. Salonen, ARI 68 (2010)1970–1979

L. Salonen, ARI 68 (2010)131–138

# Motivation



The insightful comparison of the three methods is impeded by the various interferences, and mainly by the lack of a common standard

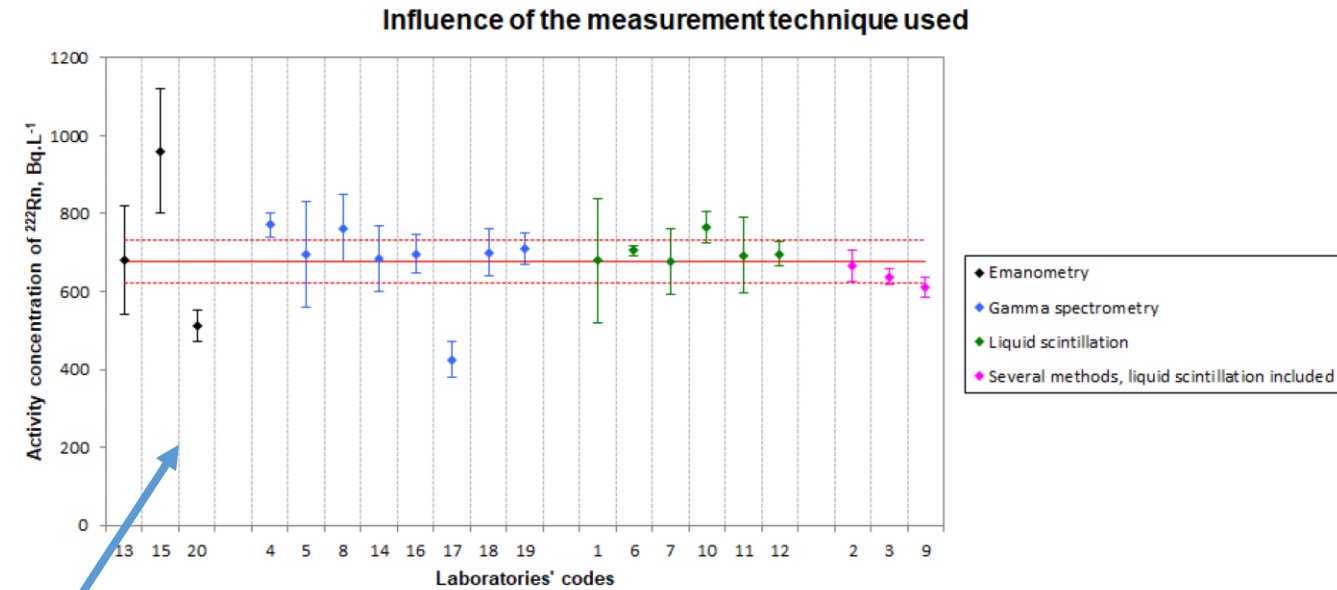
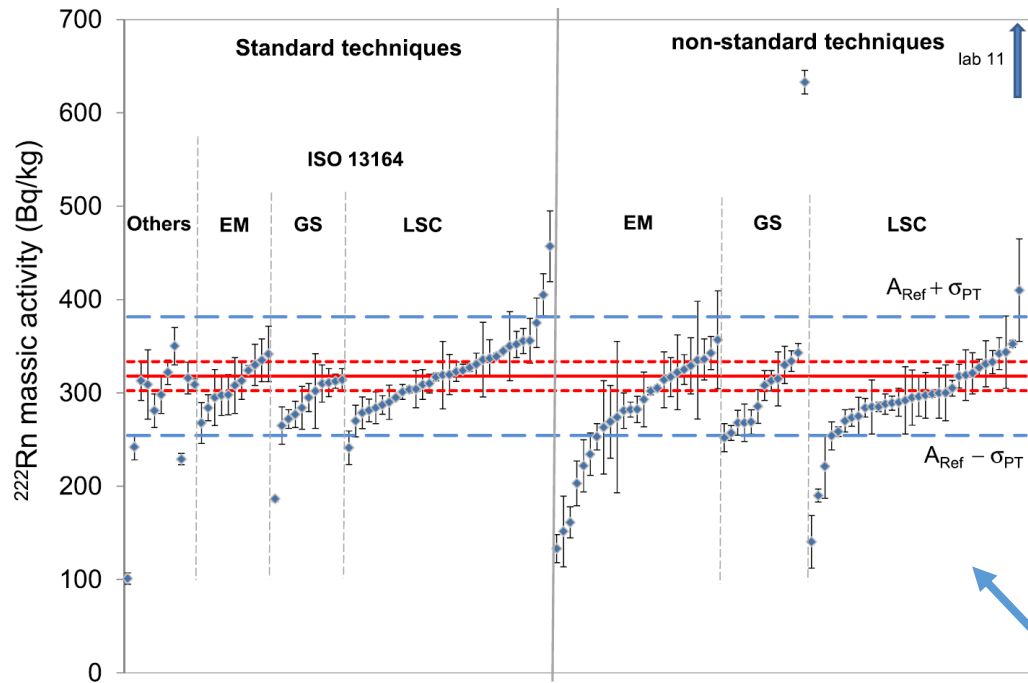

Fig. 7. Participants' results sorted on the basis of application of a standard technique. The three curves under standard/non-standard techniques represent (from left) emanometry (EM), gamma-ray spectrometry (GS) and liquid scintillation counting (LSC). For red and blue lines, see Fig. 1. (For interpretation of the references to colour in this figure legend, the reader is referred to the Web version of this article.)

[Report IRSN/2020-00754 “Results of the Proficiency Test 163 RN 300”](#)

[V. Jobbagy, M. Hult, Performance evaluation of a European scale proficiency test on radon-in-water measurements in Europe, ARI 160 \(2020\) 10911](#)



# Objectives



So, we decided that it is high time to fill this gap and try to develop a system, capable to produce a pure  $^{222}\text{Rn}$ -in-water standard.

- Pure  $^{222}\text{Rn}$ -in-water standard, not based on  $^{226}\text{Ra}$  content of the water;
- Traceable to an established  $^{222}\text{Rn}$  primary standard (the fixed  $\Omega$  method);
- Capability to prepare LSC and gamma spectrometry samples;



# Basic principle: Cryogenic transfer of $^{222}\text{Rn}$ to water



The new system (v. 1)

The fixed solid angle  $^{222}\text{Rn}$  standard

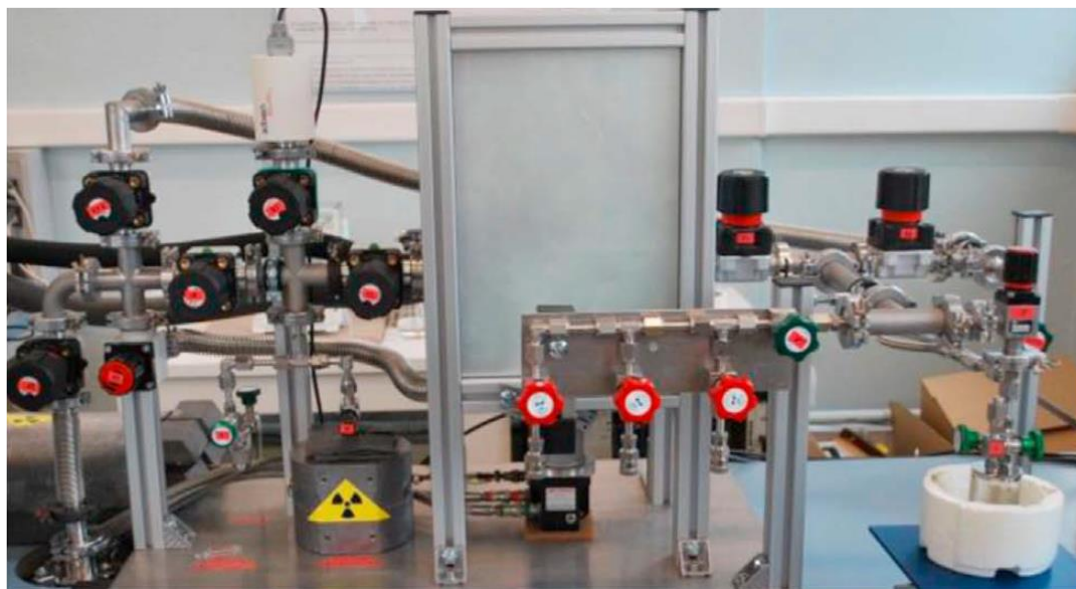

$^{222}\text{Rn}$   
transfer

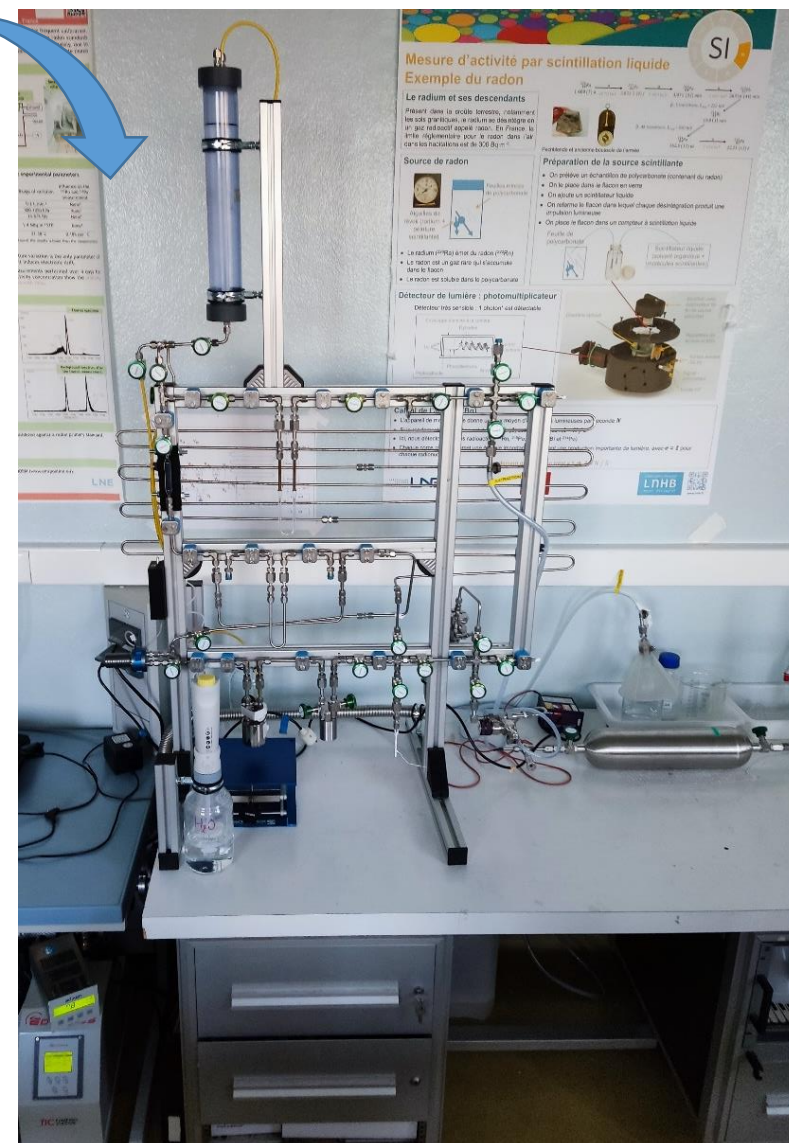

[J.L. Picolo, NIMA 369 \(1996\), 452–457](#)

[B. Sabot, S. Pierre, P. Cassette, ARI 118 \(2016\) 167–174](#)

# The new system: Design and functionality

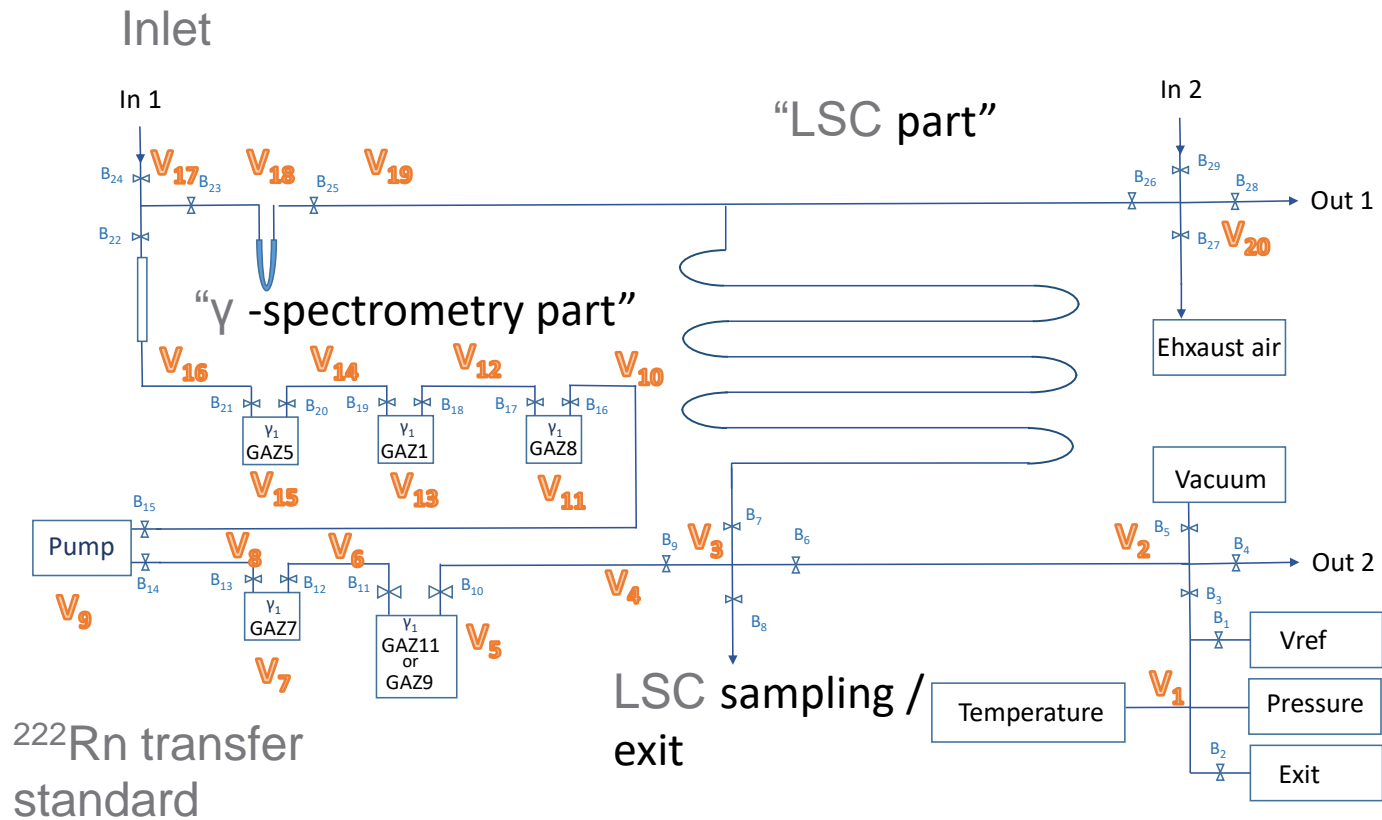



# The new system: Design and functionality



- The system can be evacuated to  $\sim 10^{-5}$  hPa
- Using P,T measurements and a reference volume we can measure the volume of the system before each experiment;
- There are glass parts which help to check what happens during the water transfer;
- Capability to prepare LSC and gamma spectrometry samples;
- Gamma spectrometry samples (6 in total) are straightforward to detach and disseminate;
- The direct production of LSC samples is more specific: we use pushing to deliver the water into the LSC cocktail



# LSC sampling: Pushing vs. Pulling

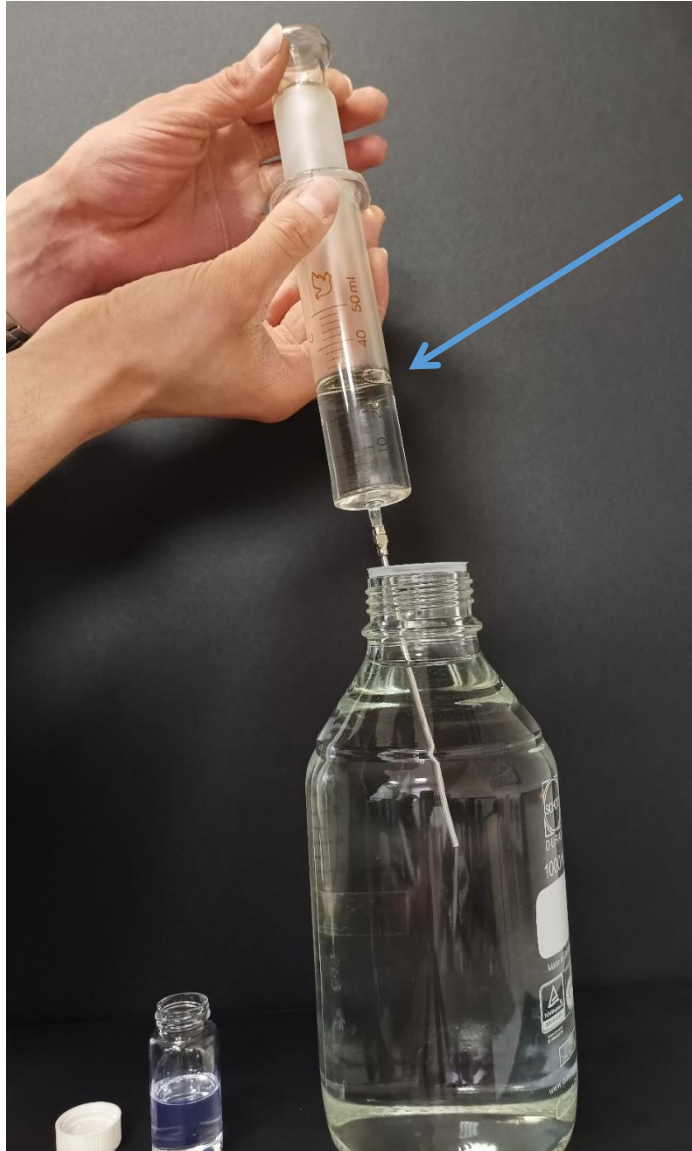

## Pulling:

- Underpressure;
- Some residual air may appear near the piston
- potential radon loss

## Pushing:

- No stress to the liquid;
- Pushing with dispensette with air or water;
- avoiding radon loss





# LSC sampling: Example with some results



The pushing method seems to work fine (good repeatability of sample preparation):



| Experiment | # samplings | mean transferred mass, g | Standard deviation, % |
|------------|-------------|--------------------------|-----------------------|
| 1          | 5           | 4.978 (11)               | 0.23 %                |
| 2          | 5           | 4.974 (19)               | 0.37 %                |
| 3          | 5           | 4.861(23)                | 0.47 %                |
| 4          | 8           | 5.009(12)                | 0.25 %                |



# LSC counting: Example with some results



We achieved also good repeatability of the sample preparation in terms of measured LSC mass specific counting rates.

| LSC, No | Source for: | Vial          | Closed at: (local) | ctime, s | time, UTC | Dtime%             | Counts        | CPM1          | CPM1%  | CPM/g        |
|---------|-------------|---------------|--------------------|----------|-----------|--------------------|---------------|---------------|--------|--------------|
| 1       | LSC         | plastic+ ptfe | 10:40              | 300      | 14:45     | 3.535              | 479579        | 99162.47      | 0.144% | 19852        |
| 2       | LSC         | plastic+ ptfe | 10:43              | 300      | 14:16     | 3.563              | 485894        | 100497.32     | 0.143% | 20006        |
| 3       | LSC         | plastic+ ptfe | 10:45              | 300      | 14:24     | 3.569              | 487156        | 100764.52     | 0.143% | 20092        |
| 4       | LSC         | plastic+ ptfe | 10:46              | 300      | 14:31     | 3.563              | 485819        | 100481.08     | 0.143% | 20077        |
| 5       | LSC         | plastic+ ptfe | 10:49              | 300      | 14:38     | 3.569              | 487029        | 100737.62     | 0.143% | 20114        |
| 6       | LSC         | plastic+ ptfe | 10:50              | 300      | 14:58     | 3.574              | 487981        | 100940.11     | 0.143% | 20055        |
| 7       | LSC         | plastic+ ptfe | 10:52              | 300      | 14:52     | 3.561              | 485324        | 100377.28     | 0.144% | 20062        |
| 8       | LSC         | plastic+ ptfe | 10:54              | 300      | 15:06     | 3.561              | 485262        | 100364.04     | 0.144% | 20017        |
|         |             |               |                    |          |           | <b>LSC sources</b> |               |               |        |              |
|         |             |               |                    |          |           | <b>Mean:</b>       | <b>486352</b> | <b>100595</b> |        | <b>20060</b> |
|         |             |               |                    |          |           | <b>Stdev:</b>      | <b>1041</b>   | <b>220</b>    |        | <b>39</b>    |
|         |             |               |                    |          |           | <b>Stdev, %</b>    | <b>0.21%</b>  | <b>0.22%</b>  |        | <b>0.19%</b> |

# Comparison LSC - Solid angle – Gamma - Spectrometry



HPGe  
measurements of  
the  $\gamma$ -spectrometry  
source at three  
different distances



## HPGE efficiency calibration @contact

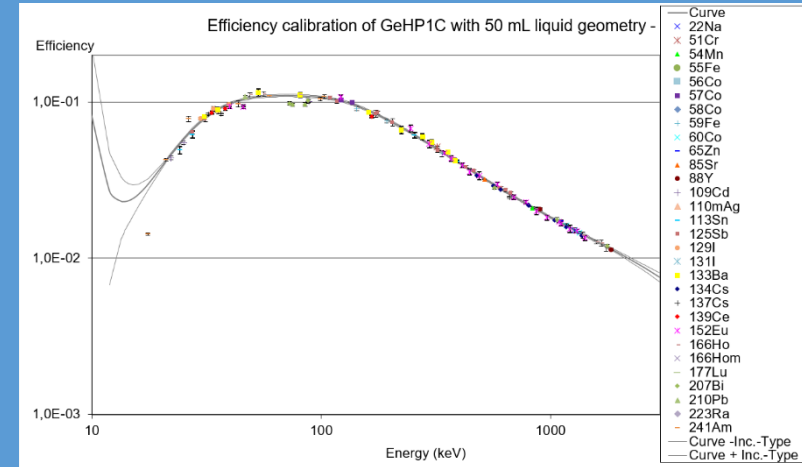

|        | LSC                        | Preparation method                         |        |
|--------|----------------------------|--|--------|
|        | Am, Bq/g (@ ref DT)<br>LSC | Am, Bq/g (@ ref DT)<br>Defined solid angle | Delta  |
|        | 101.06                     | 101.59                                     | -0.52% |
|        | 101.16                     | 101.59                                     | -0.42% |
|        | 101.63                     | 101.59                                     | 0.04%  |
|        | 101.62                     | 101.59                                     | 0.03%  |
|        | 101.74                     | 101.59                                     | 0.15%  |
|        | 101.45                     | 101.59                                     | -0.13% |
| Mean:  | 101.44                     | Mean Delta:                                | -0.14% |
| Stdev: | 0.25                       |  |        |
| %      | 0.25%                      |  |        |

$A_m$ , Bq/g    LSC:    Fixed  $\Omega$ :  
 101.4(15)    101.59(51)

|   | Vol    | E, keV    | h, cm          | Am, Bq/g | $\sigma_{Am}$ , Bq/g | $\delta_{Am}$ , % |
|---|--------|-----------|----------------|----------|----------------------|-------------------|
| At reference distance                         | Gaz 11 | 352 keV   | 10             | 101.3    | 1.6                  | 1.6%              |
|   | Gaz 11 | 295 keV   | 10             | 106.8    | 2.8                  | 2.6%              |
|   |        | h_ref     | <b>Average</b> | 102.8    | 3.4                  | 3.3%              |
| At 20 cm, efficiency transfer with ETNA       | Gaz 11 | 352 keV   | 20             | 103.3    | 7.0                  | 6.8%              |
|   | Gaz 11 | 295 keV   | 20             | 109.4    | 7.7                  | 7.0%              |
|   |        | avec Etna | <b>Average</b> | 106.0    | 7.4                  | 7.0%              |
| At contact, with the corresponding efficiency | Gaz 11 | 352 keV   | 0.45           | 91.3     | 2.6                  | 2.8%              |
|   | Gaz 11 | 295 keV   | 0.45           | 91.7     | 1.9                  | 2.1%              |
|   |        | Contact!  | <b>Average</b> | 91.6     | 1.9                  | 2.1%              |



# TDCR measurements of Rn-in-water samples



Cocktail: UltimaGold AB

Coincidence window: 40 ns

Extendable dead time (always)

Decay, blank and accidental coincidence corrections

Correction for  $^{214}\text{Po}$  decay within the dead time by two methods:

Extrapolation to zero-dead time

Analytical efficiency calculation

TDCR acquisition systems:

(B. Sabot et. al, NIMA, 1034 (2022) 166721)

MicroTDCR + CAEN digitizer (sample a4) - 102.58(41) Bq/g

MicroTDCR + nanoTDCR analyzer (sample a5) - 102.76 (41) Bq/g

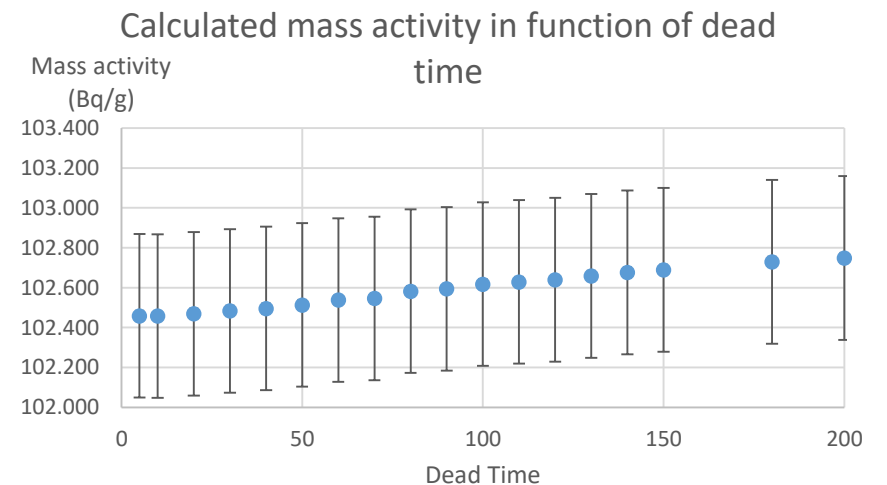
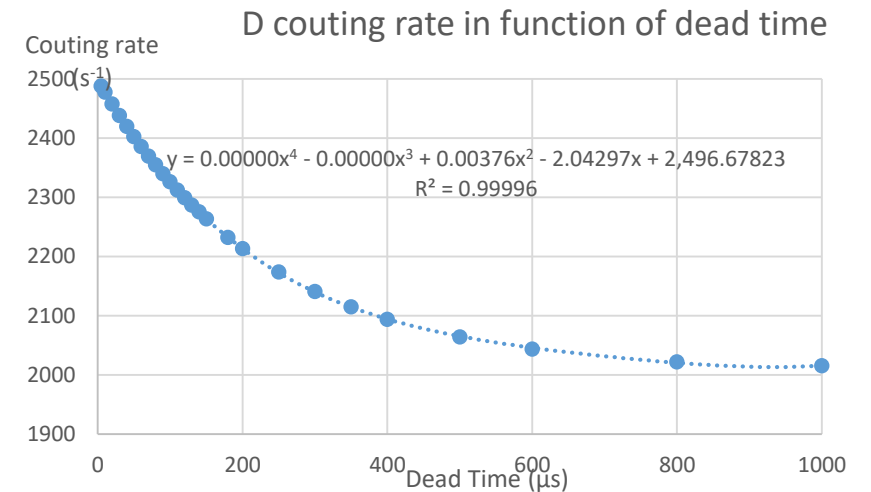

# All in one

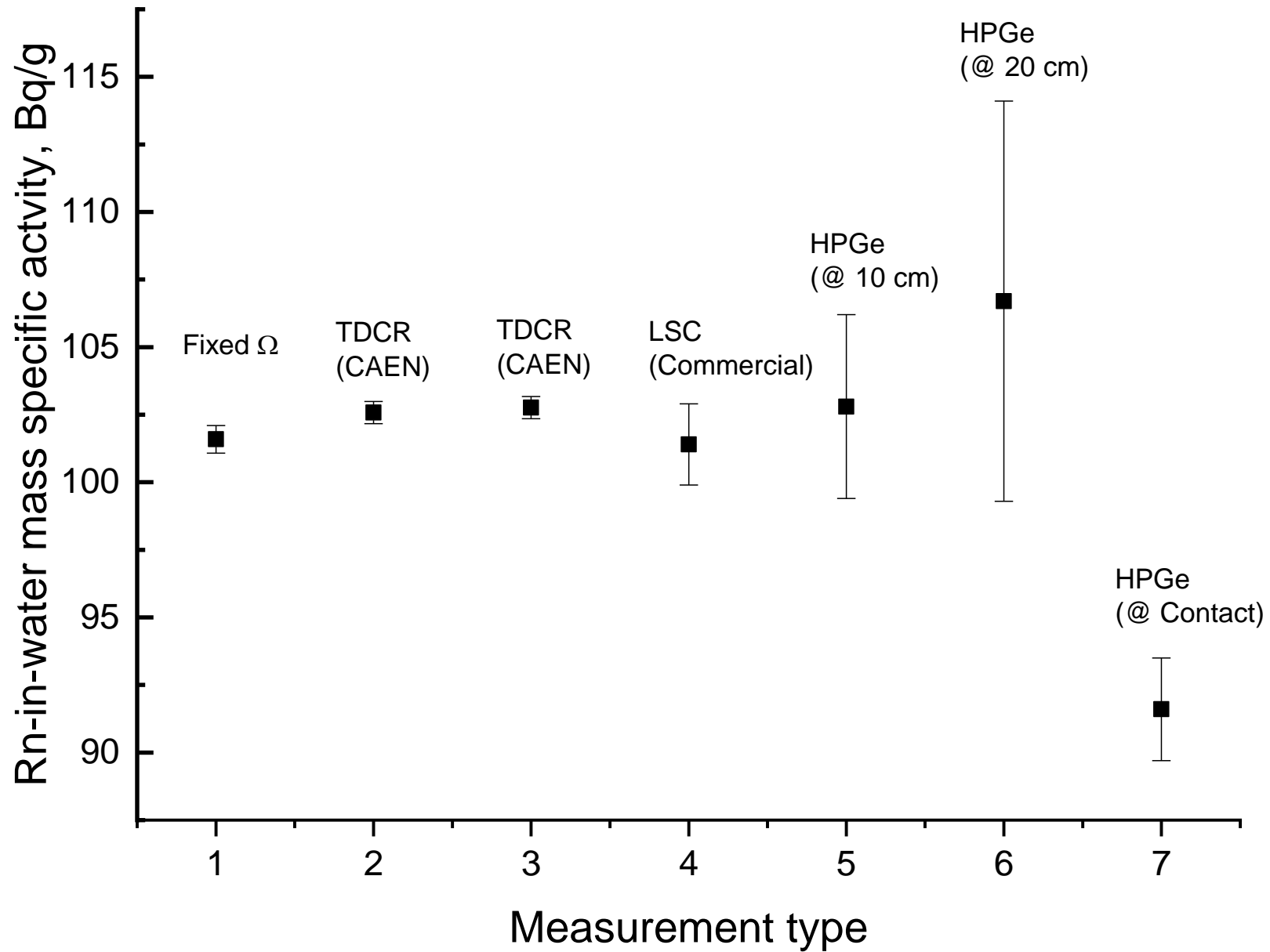

01

A system, capable to transfer radon from the primary radon standard to water without losses is designed. The pilot experiments show that the selected approach is feasible.

02

The system allows to prepare radon-in-water samples for gamma-spectrometry and LSC

03

These developments will allow a direct comparison of the radon-in-water measurement techniques as well as application of absolute methods (e.g. TDCR counting) for radon-in-water standardization and unit dissemination.



# Some pictures of the various versions of the system

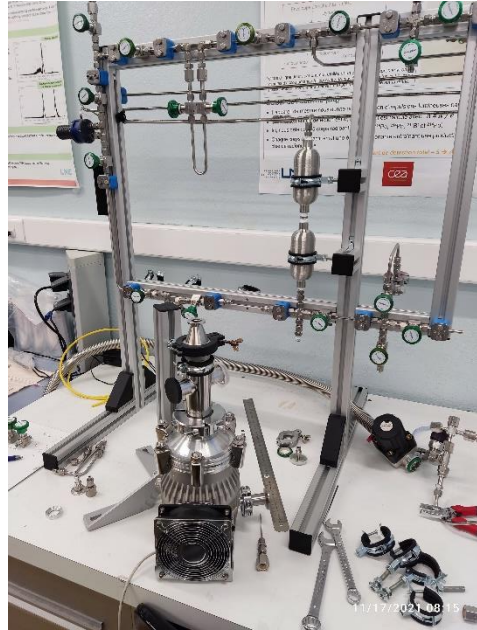



*This work is performed with the financial support from LNE. K.M. would like to express gratitude for the financial support provided by LNE for two short-term visits at LNHB, which enabled his participation.*

*K.M. and B.S., which contributed equally to this work, would like to thank the colleagues from LNHB for the support in difficult moments!*

*Thank you for your attention.*