



**HAL**  
open science

# Fast plastic scintillator and SiPM based devices for FLASH beams monitoring

Victor Buridon

► **To cite this version:**

Victor Buridon. Fast plastic scintillator and SiPM based devices for FLASH beams monitoring. ANIMMA 2023 - The 8th International Conference on Advancements in Nuclear Instrumentation Measurement Methods and their Applications, Jun 2023, Lucca, Italy. cea-04239671

**HAL Id: cea-04239671**

**<https://cea.hal.science/cea-04239671v1>**

Submitted on 12 Oct 2023

**HAL** is a multi-disciplinary open access archive for the deposit and dissemination of scientific research documents, whether they are published or not. The documents may come from teaching and research institutions in France or abroad, or from public or private research centers.

L'archive ouverte pluridisciplinaire **HAL**, est destinée au dépôt et à la diffusion de documents scientifiques de niveau recherche, publiés ou non, émanant des établissements d'enseignement et de recherche français ou étrangers, des laboratoires publics ou privés.



Fast plastic scintillator and SiPM based devices for FLASH beams monitoring

V. Buridon

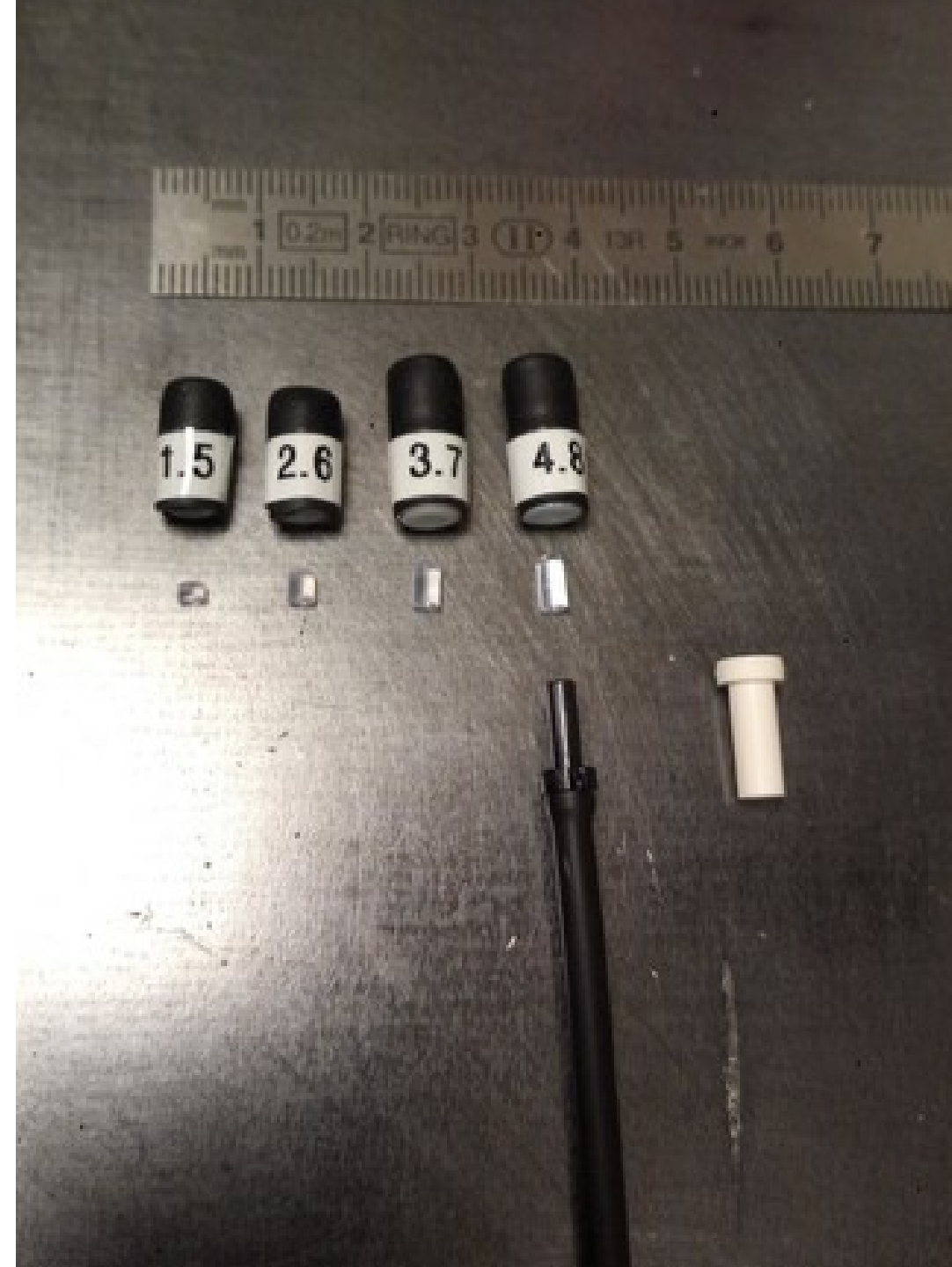

# Summary

1.Context

2.Motivations and contents

3.Results

4.Conclusions and future developments





# 1 ■ Context

# General context

## Treatments techniques against solid tumors

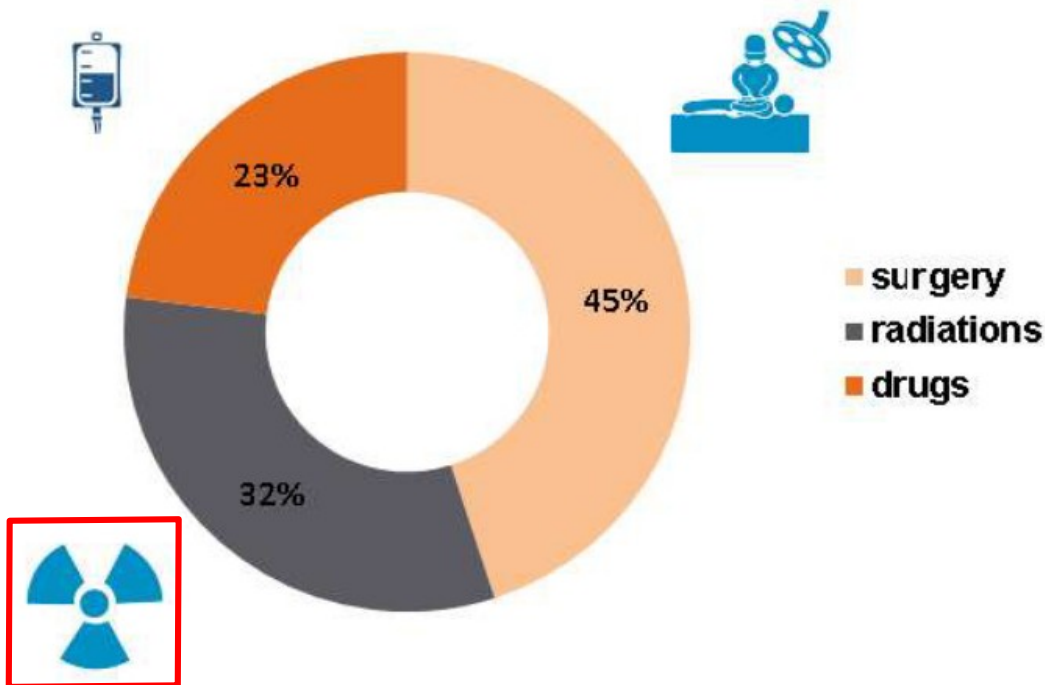

## Techniques used in conformal radiotherapy

- LINACS with low energy  $e^-$  beams.
- LINACS with intra-operative  $e^-$  RT.
- Carbon ions (high LET particles).
- Protons beams (cyclotrons ...).
- Very High Energy  $e^-$  beams (VHEE).
- X rays (synchrotron or X ray tubes).

→ **Conventional and FLASH Beams**

# Conventional and FLASH Beams



- Install in September 2020 in Centre de Recherche – Orsay



- Only electrons 5MeV or 7MeV.
- 2 modes : conventional and FLASH.
- Specific monitor system for each mode.
- Field size between 12cm and 1cm of diameter (applicators).
- Dose flowrate between 0.1-1000Gy/s on the field of diameter 10cm.
- Dose/pulse : [1,25] Gy/pulse.

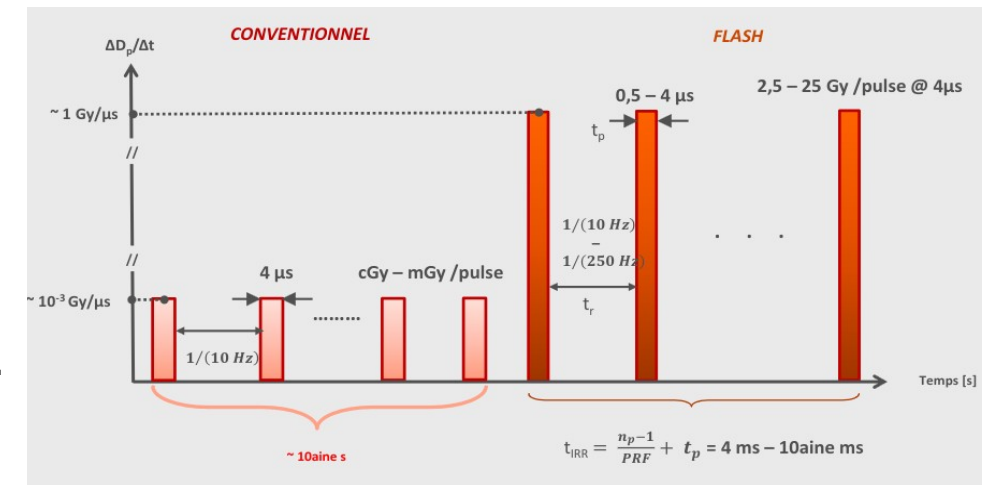



# 2 ■ Motivations and contents

# Problematic

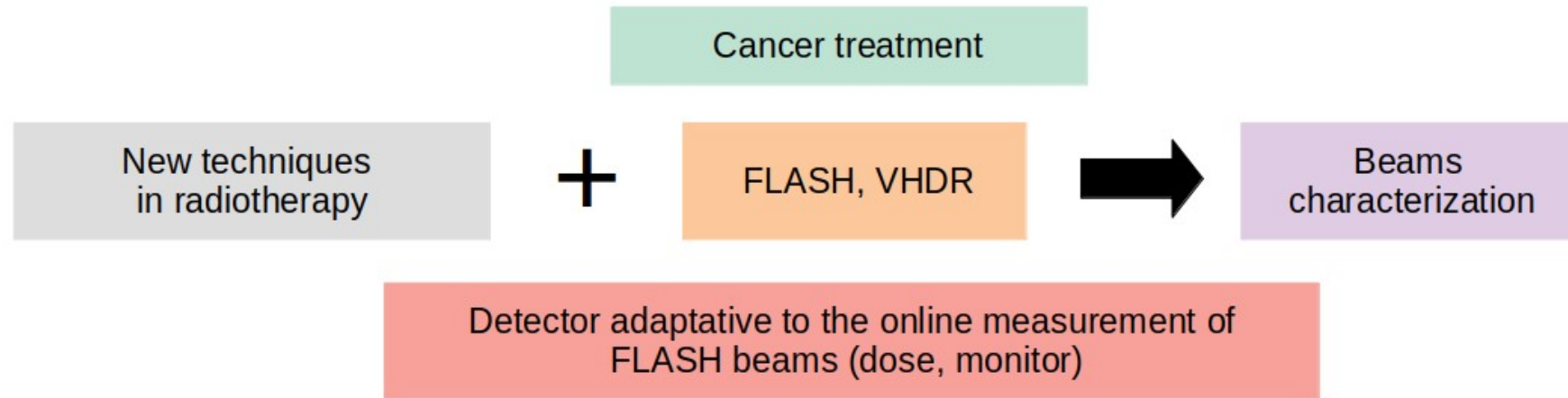

## Difficulties in FLASH beams :

- Saturation of existing dosimeters :
  - Ionisation chambers
  - diodes
- EBT (passive dosimeters) not adapted for clinical uses.

## Alternative technology :

- Coupling chemically modified scintillator with a SiPM.
- Requirements :
  - Twin-device without scintillator to estimate the Cerenkov contribution.
  - Wave guide to export the electronics out of beam.



# Dosimeters properties and specifications

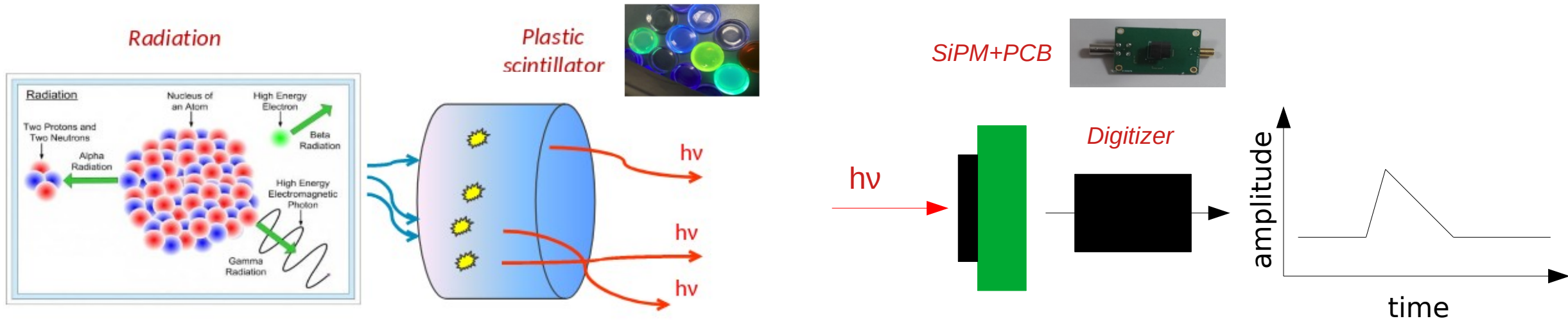

**ASTROLABE** project : **f**ast **S**cin**T**illato**R** based device for **O**n line **FLASH** **B**Eam dosimetry.

## Scintillator characteristics

- High scintillation yield.
- Linearity between light yield and radiation energy.
- High transparency to the scintillation light.
- Fast response
- Good spectral matching
- High stability in harsh environment.

## Point dosimeter specifications

- Temporal resolution : 5-10ns (1% of precision for a pulse of 1 $\mu$ s).
- $\lambda_{\text{emission}}$  : [420-600]nm.



# 3 ■ Results

# Fast plastic scintillators synthesis



## Polymer matrice

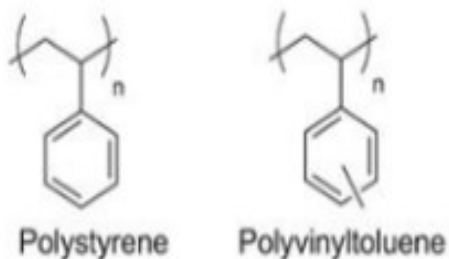

## Primary fluorophore

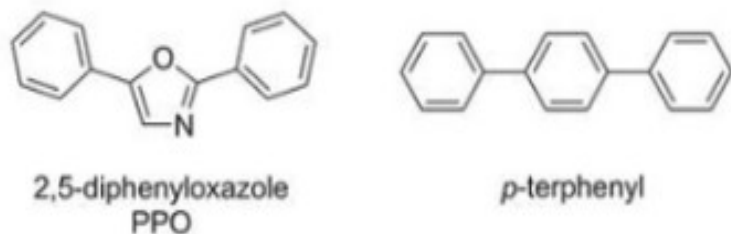

## Secondary fluorophore

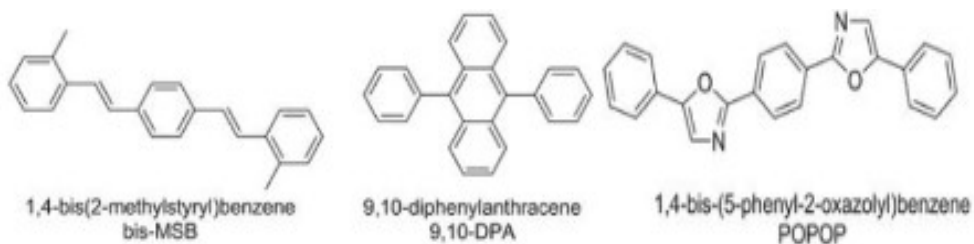

Scintillators	Chemical composition (%)	$\lambda_{\max}$ emission (nm)
A	99.9% Styrene 0.1% CM30	474
B	99.9% Styrene 0.1% BBQ	389
C	99.9% Styrene 0.1% DCM	551
D	99.9% Styrene 0.1% PBD	382
E	96.9% Styrene 3% PPO 0.1% MSB	445
F	99.9% Styrene 0.1% Pterphenyl	383

# Scintillators characterization and selection

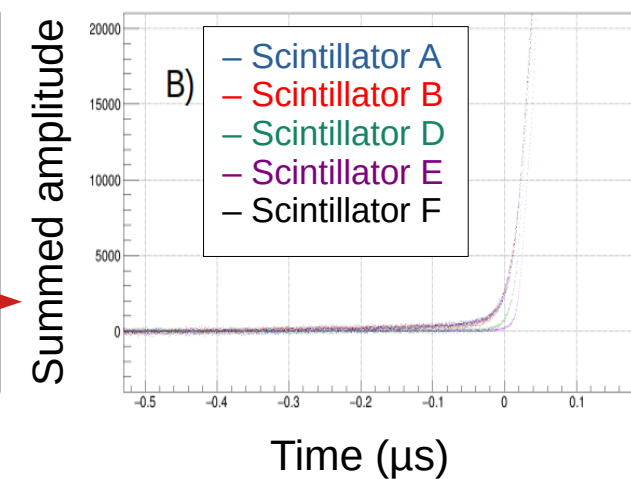
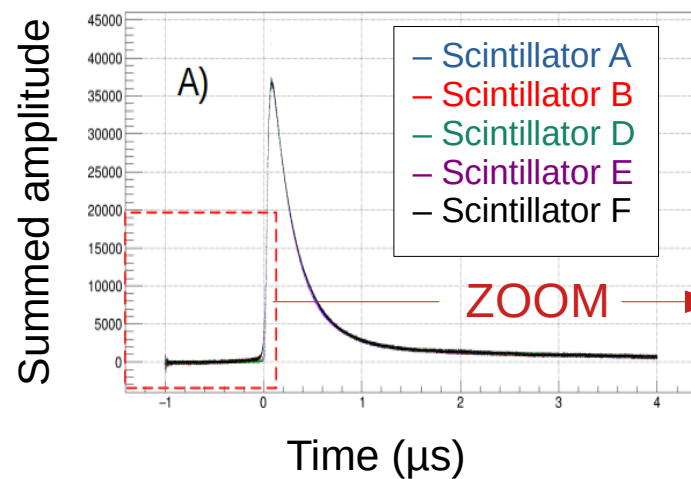
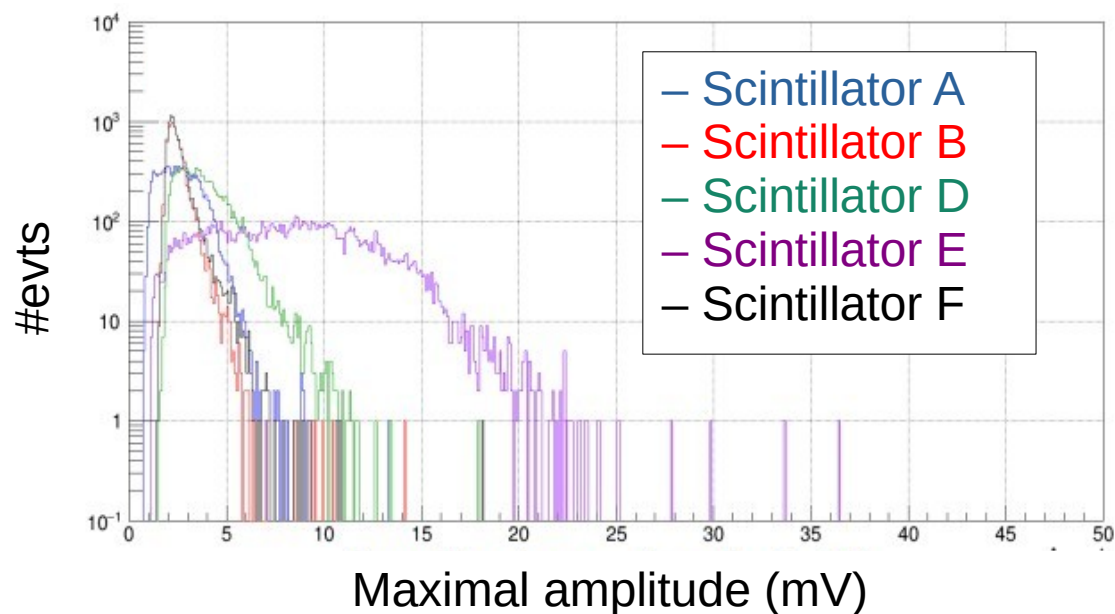
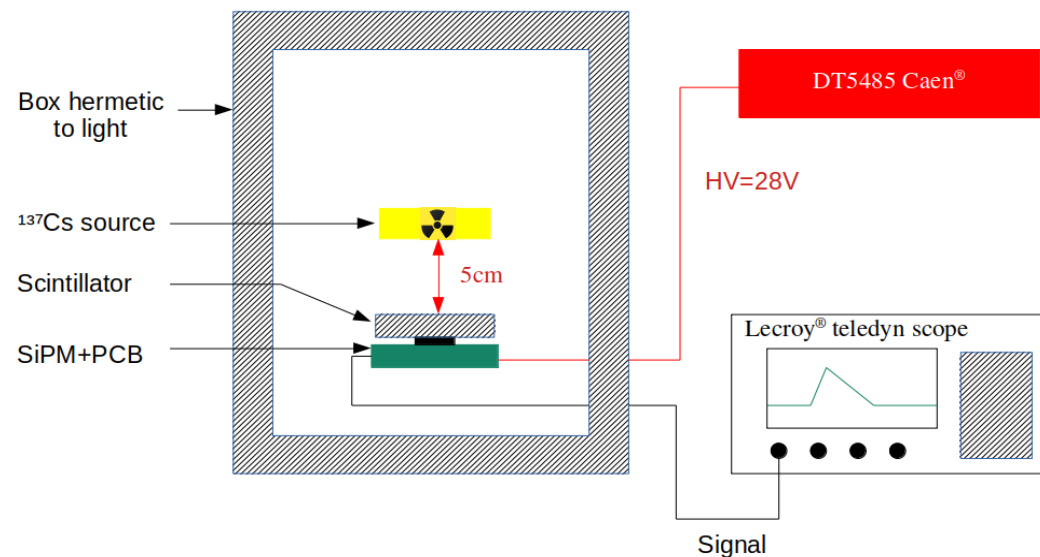
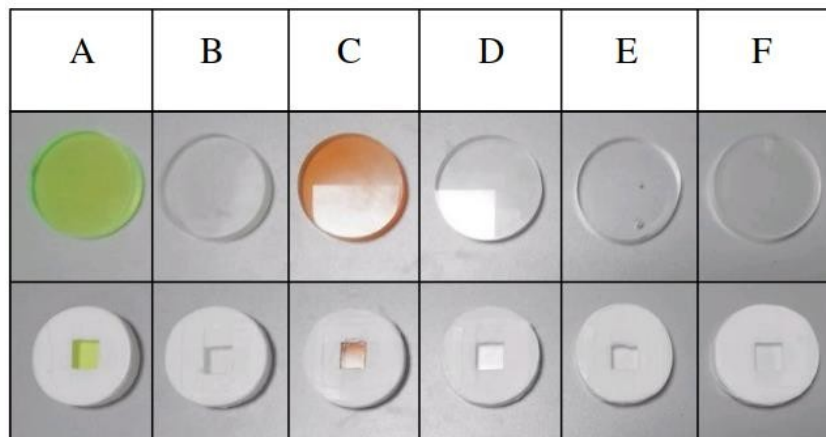

# Set-up assembly (point dosimeters)



**Scintillator E**  
(Length : 0.6mm, Diam. : 6mm)

**PMMA wave guide**  
(Length : 23cm, Diam. : 6mm)

**SiPM**

**Digitizer or scope**

**Computer**

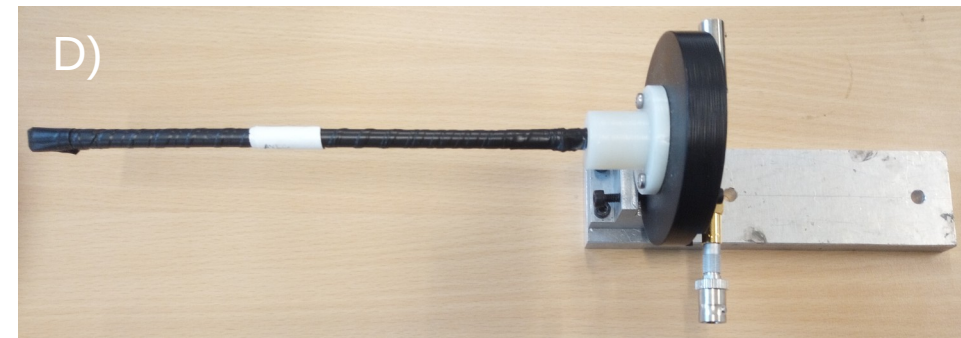
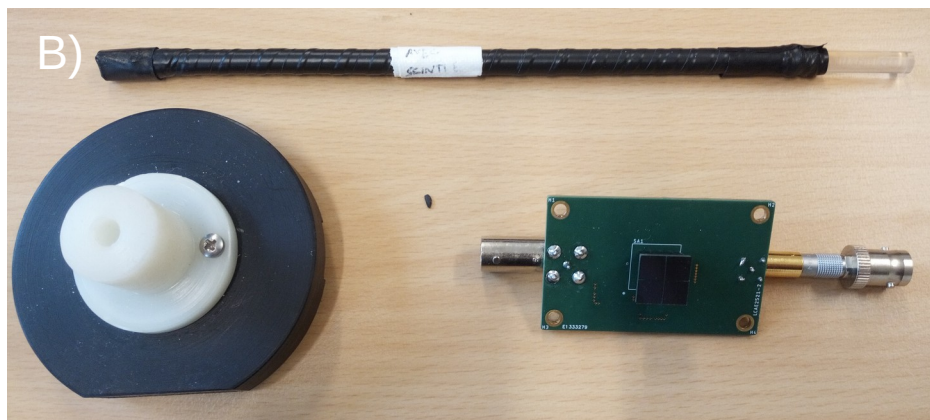
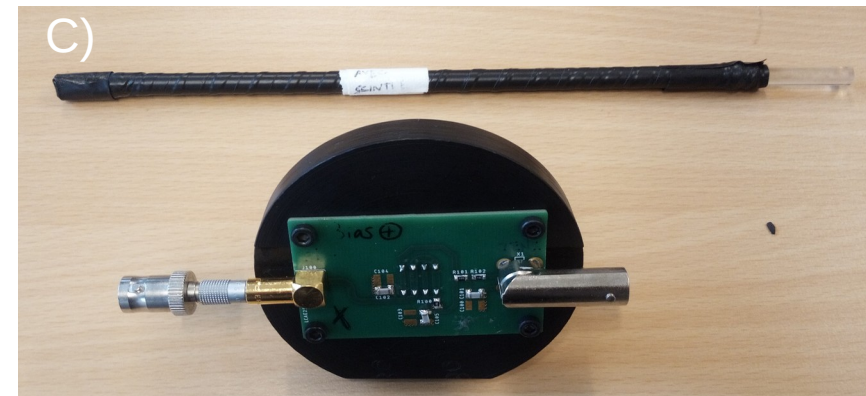
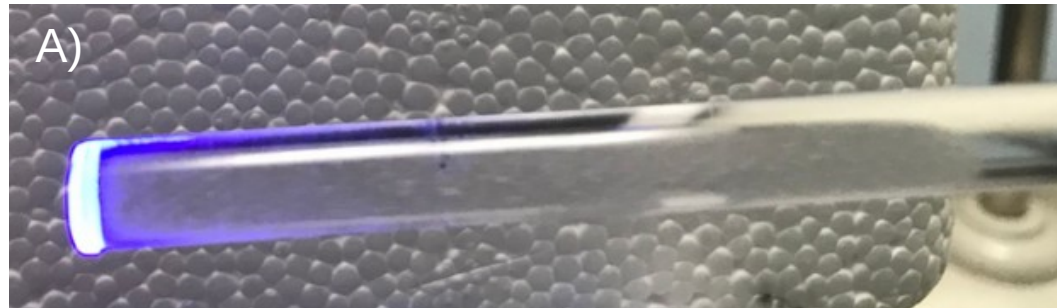

# Measurements on FLASH Beam

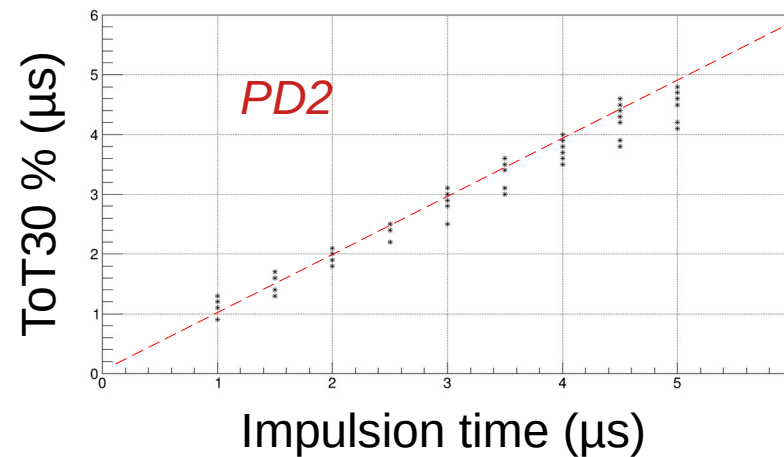
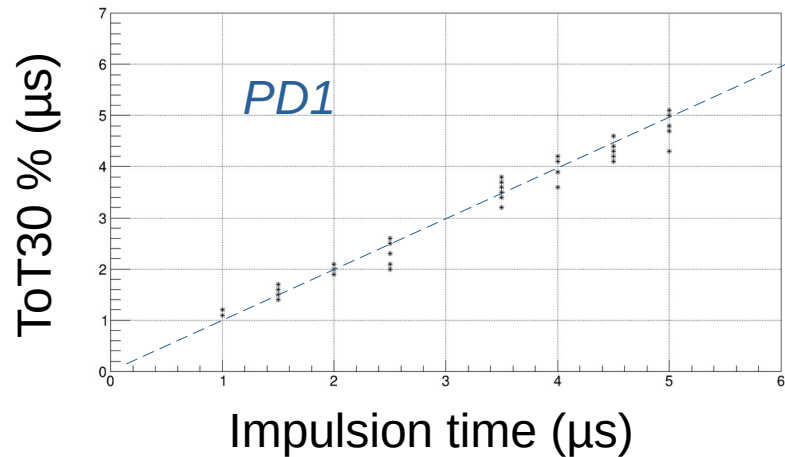
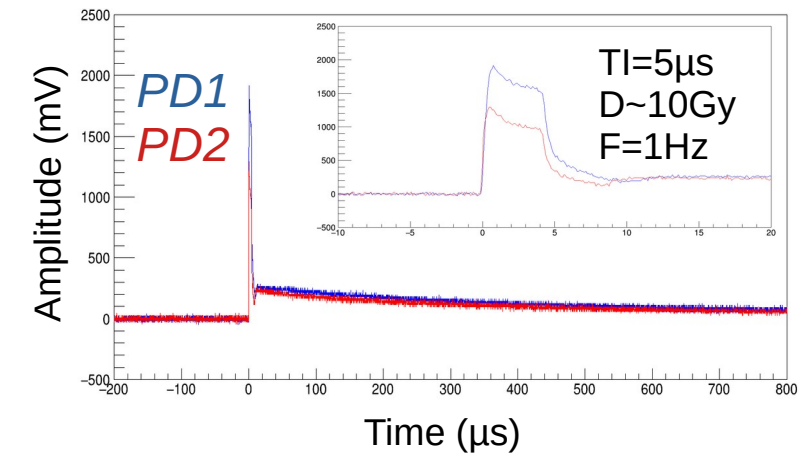
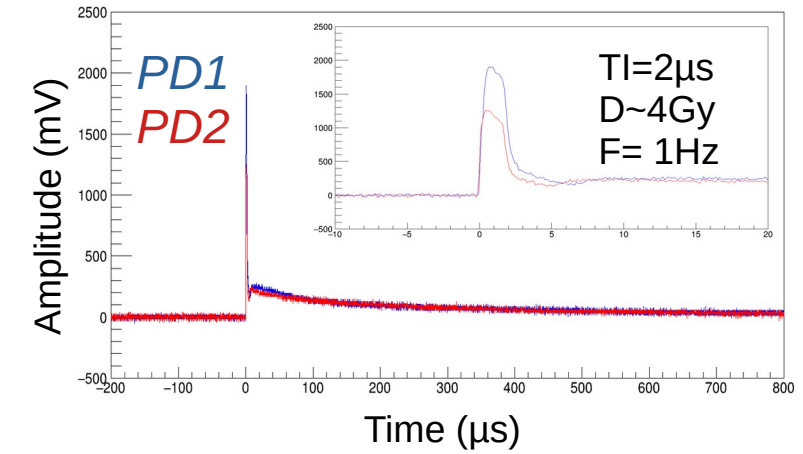
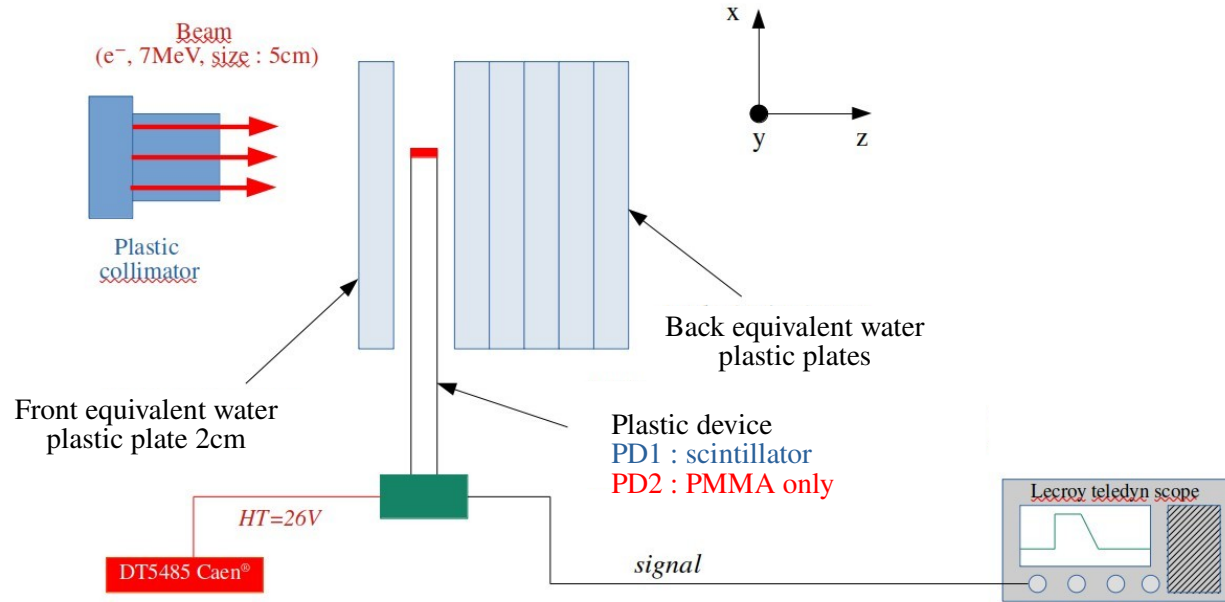

# Measurements on FLASH Beam

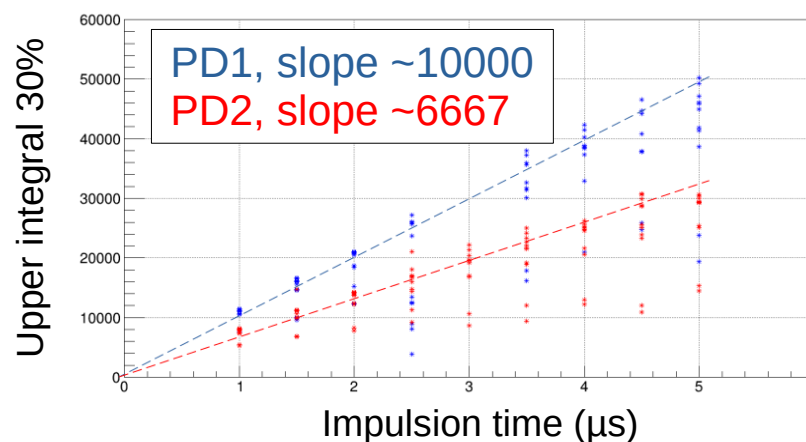
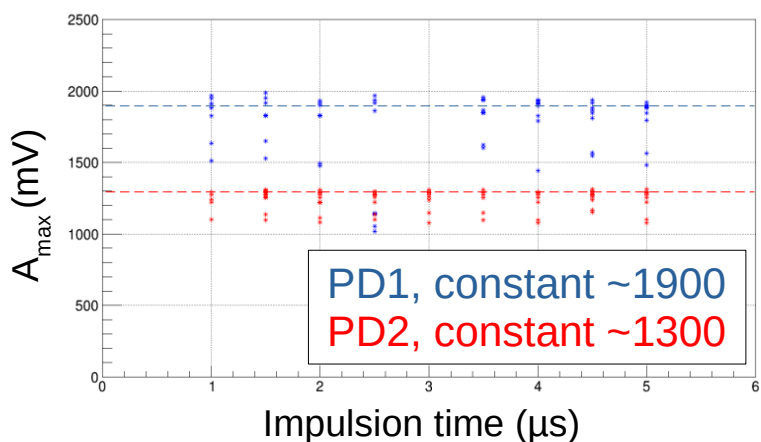
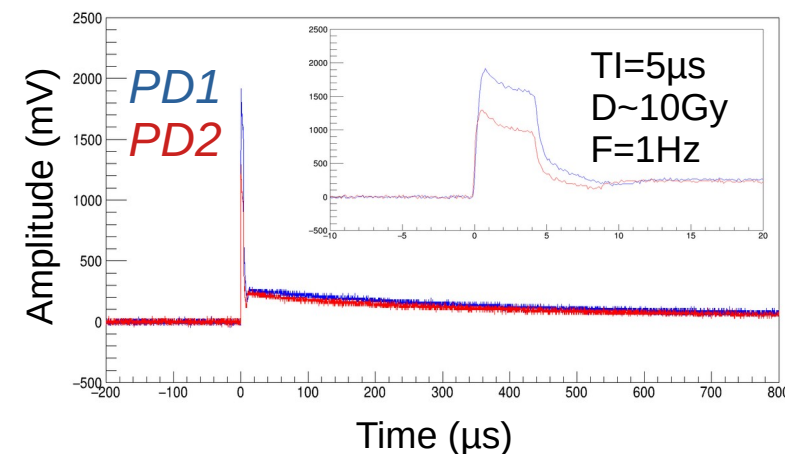
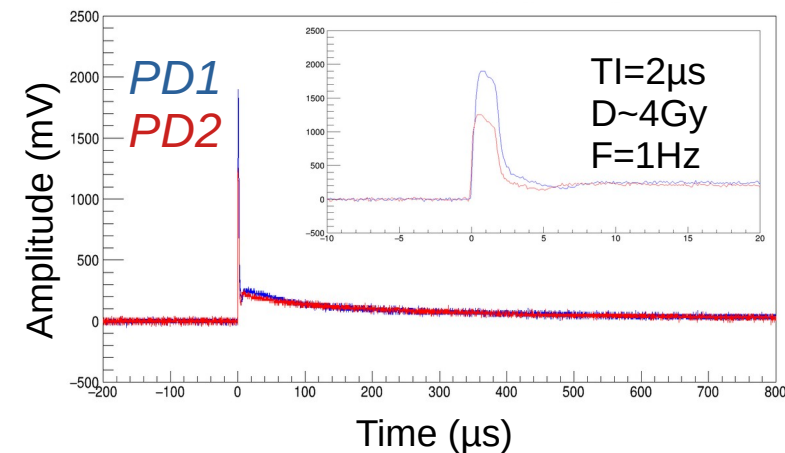
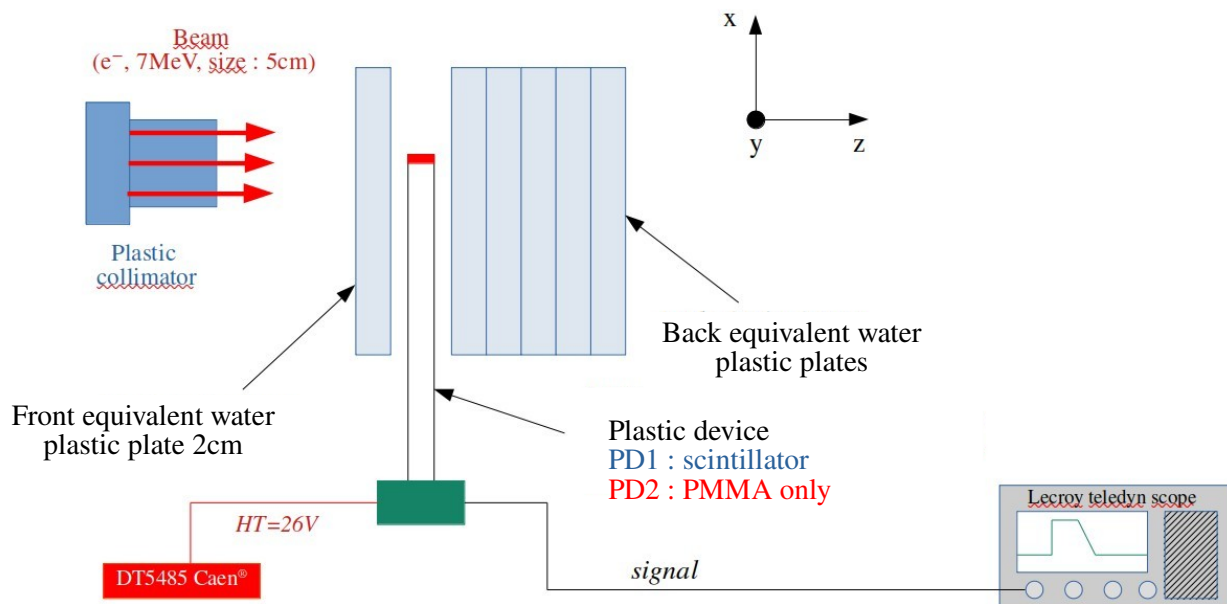

**Cerenkov = 68.42%**

**Cerenkov = 66.67%**

# Measurements on FLASH Beam

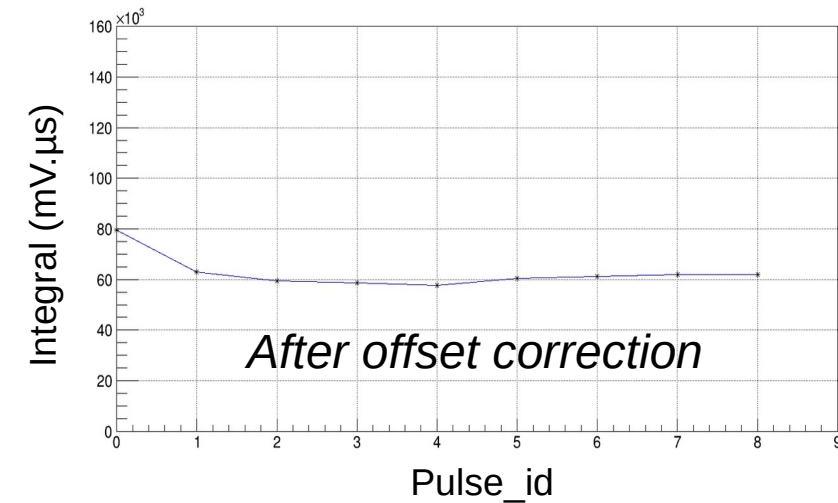
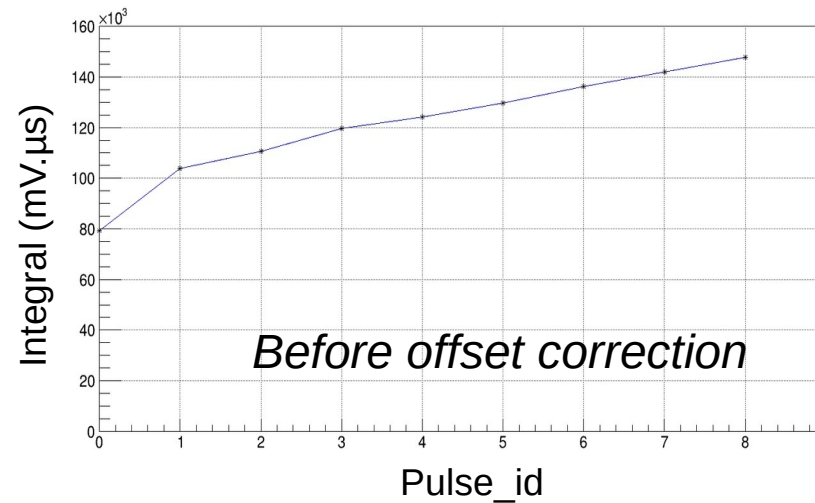
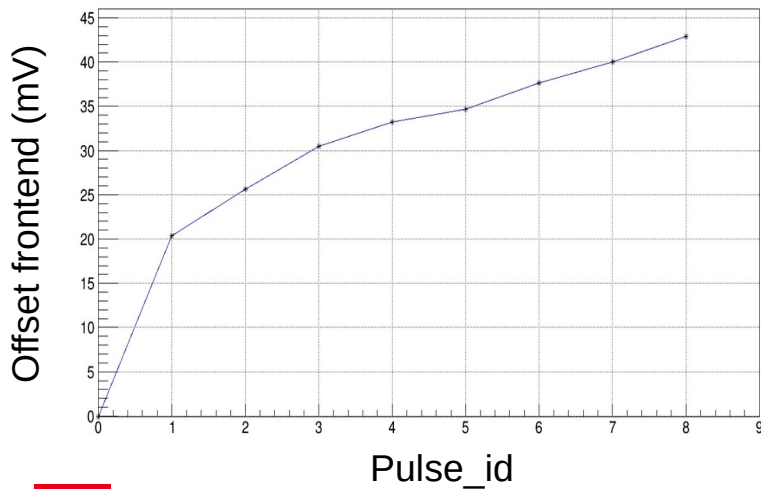
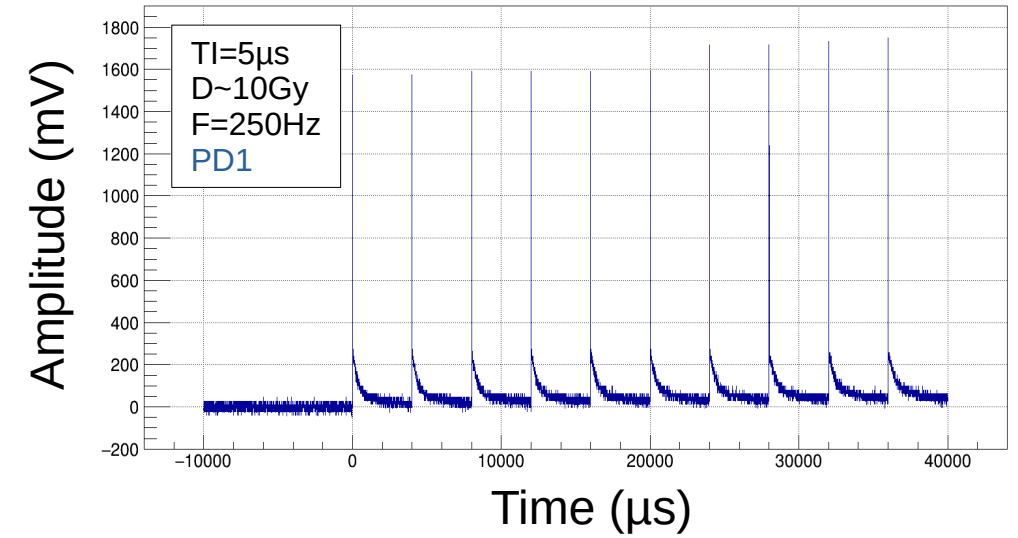
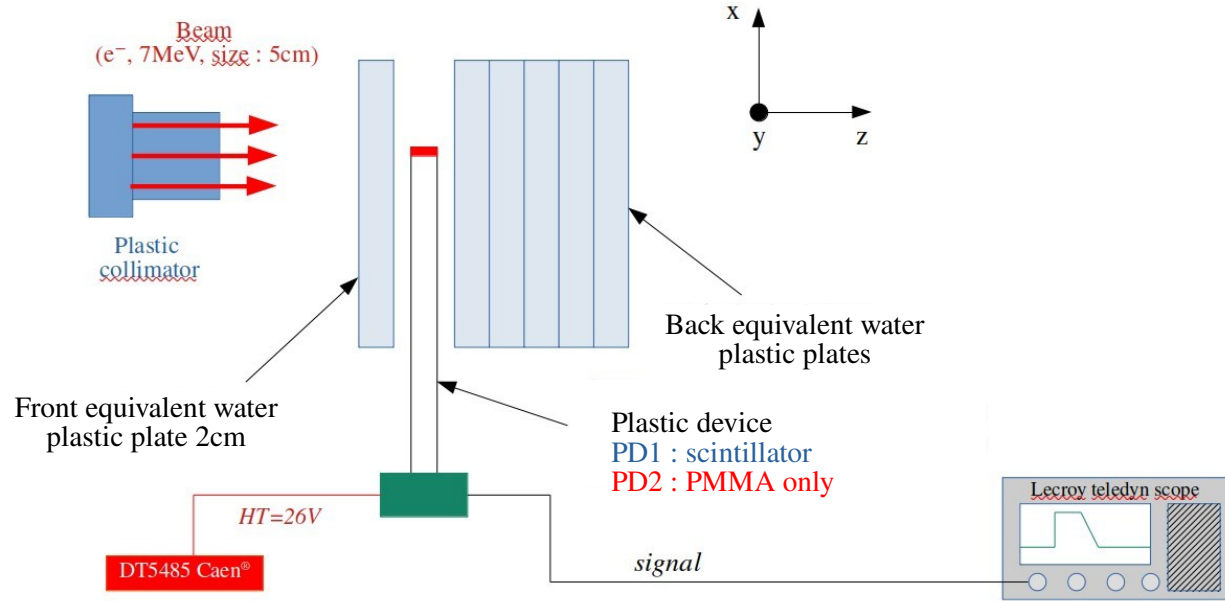





# 4 ■ Conclusions and future developments

# Conclusion and future developments



list



## Point dosimeter

- Setup modification
  - scintillator **molding**
- Modification of **chemical formulation**
- Improvement of signal readout
  - using “**fast**” output of SiPMs
  - set-up **shielding**
- Mounting set-up using **PMMA fiber** as wave guide
  - Measurements carried out on **FLASH beams**.

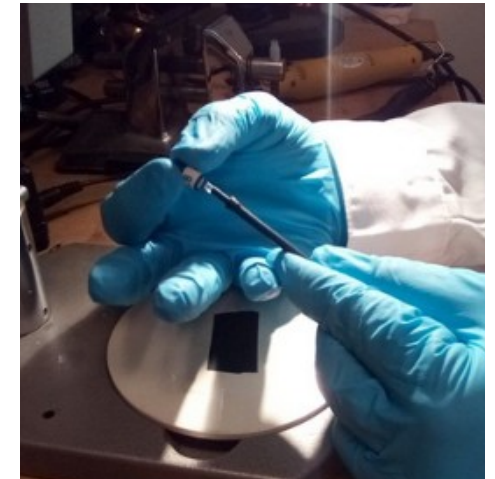
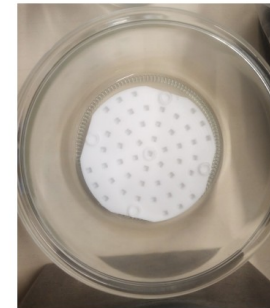

## FLASH Beam monitor

- Setup based on fibers “carpet”.

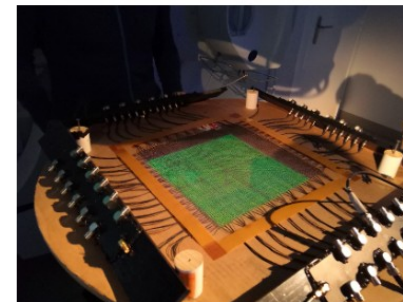

# Aknowledgement



*M. Agelou, G. H. V. Bertrand, G. Boissonnat, V. Buridon, C. Lynde, J. J. Nahimana, J. Plagnard, D. Tromson  
A. Bonfrate, S. Heinrich, S. Kaur, A. L. Patriarca, L. De Marzi*

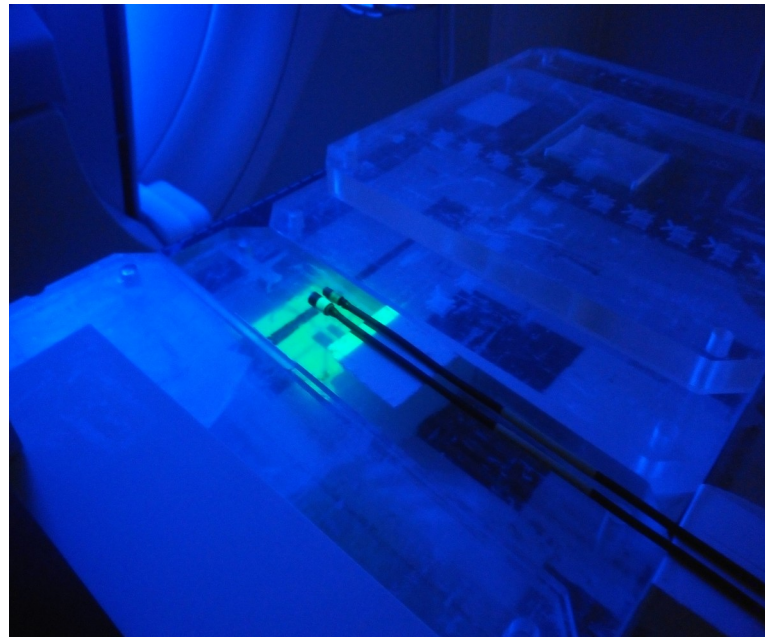
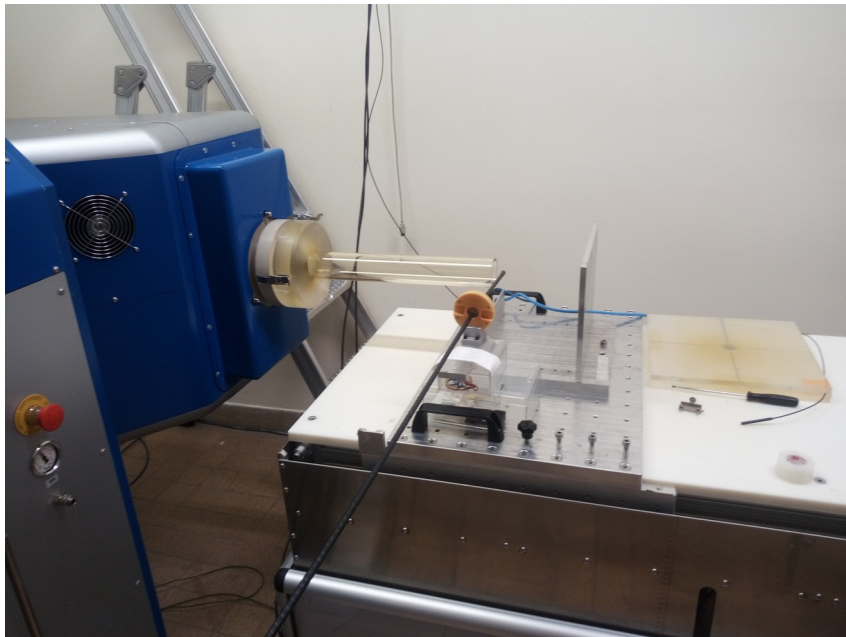



Thank you for your attention