



**HAL**  
open science

# Radon Metrology: Advancements and Challenges in International Indoor Air Quality Assessment

Benoit Sabot

► **To cite this version:**

Benoit Sabot. Radon Metrology: Advancements and Challenges in International Indoor Air Quality Assessment. Séminaire du Bureau International des Poids et mesure, Bureau International des Poids et mesure (BIPM), May 2023, On Line, France. cea-04187442

**HAL Id: cea-04187442**

**<https://cea.hal.science/cea-04187442>**

Submitted on 24 Aug 2023

**HAL** is a multi-disciplinary open access archive for the deposit and dissemination of scientific research documents, whether they are published or not. The documents may come from teaching and research institutions in France or abroad, or from public or private research centers.

L'archive ouverte pluridisciplinaire **HAL**, est destinée au dépôt et à la diffusion de documents scientifiques de niveau recherche, publiés ou non, émanant des établissements d'enseignement et de recherche français ou étrangers, des laboratoires publics ou privés.



# Radon Metrology: Advancements and Challenges in International Indoor Air Quality Assessment

Benoît Sabot, Ph.D.

Laboratoire National Henri Becquerel (LNHB)



# Contents

Introduction

Primary standards for radon

The use of primary radon standards and calibration

Primary standards for thoron

Radon measurement and considerations

Unusual example of the use of radon standards



# 1 ■ Introduction

Radon, a natural radioactive gas

# Introduction

- Radon is one of the natural radiation source
  - Can be the main one depending on area and building
- According to the World Health Organisation, radon is estimated to cause between 3% to 14% of all lung cancers
- There are different isotopes
  - Radon:  $^{222}\text{Rn}$  (3.8232 d) from  $^{238}\text{U}$  decay chain
  - Thoron:  $^{220}\text{Rn}$  (55.8 s) from  $^{232}\text{Th}$  decay chain
  - Actinon:  $^{219}\text{Rn}$  (3.98 s) from  $^{235}\text{U}$  decay chain

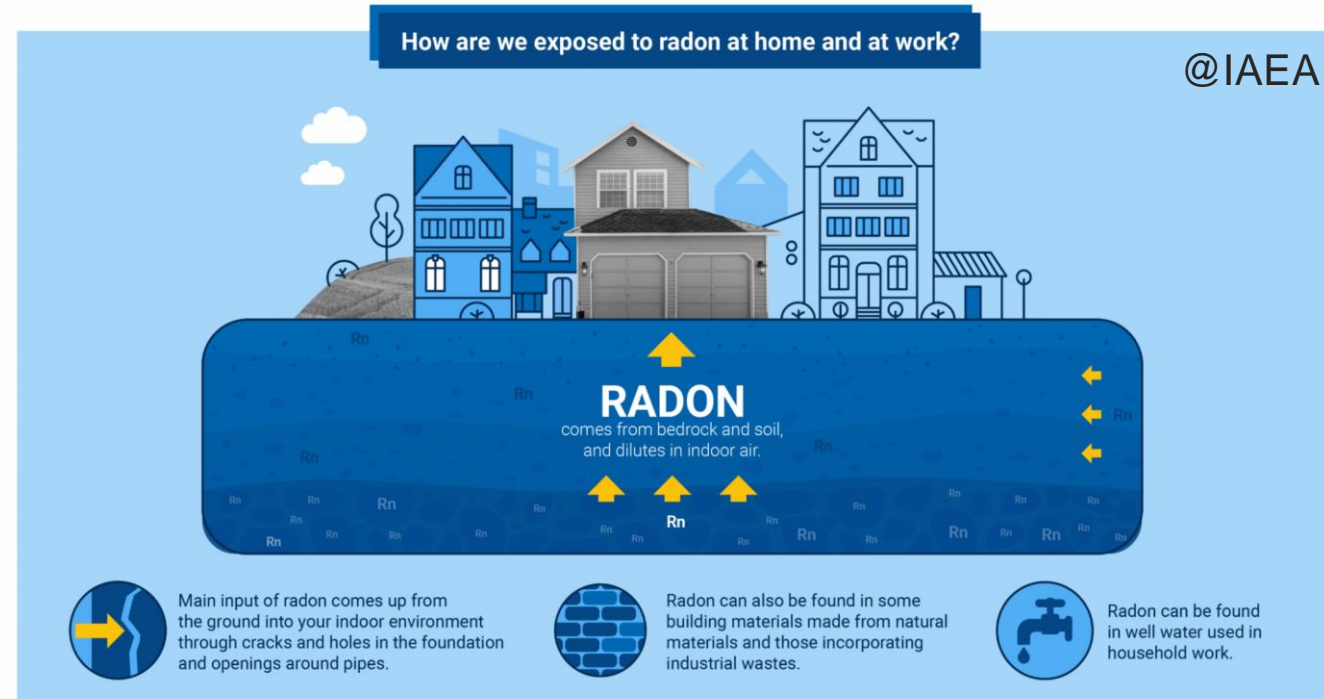

NuclearExplained

# Radon risks

- Radon in air risk is for everyone
  - At home depending on the ground and building materials
  - At workplaces, especially in mines
- WHO recommendation for public:  $100 \text{ Bq}\cdot\text{m}^{-3}$
- European guidelines inside building:  $300 \text{ Bq}\cdot\text{m}^{-3}$
- Radon in water is also a non-negligible factor for public health and worker

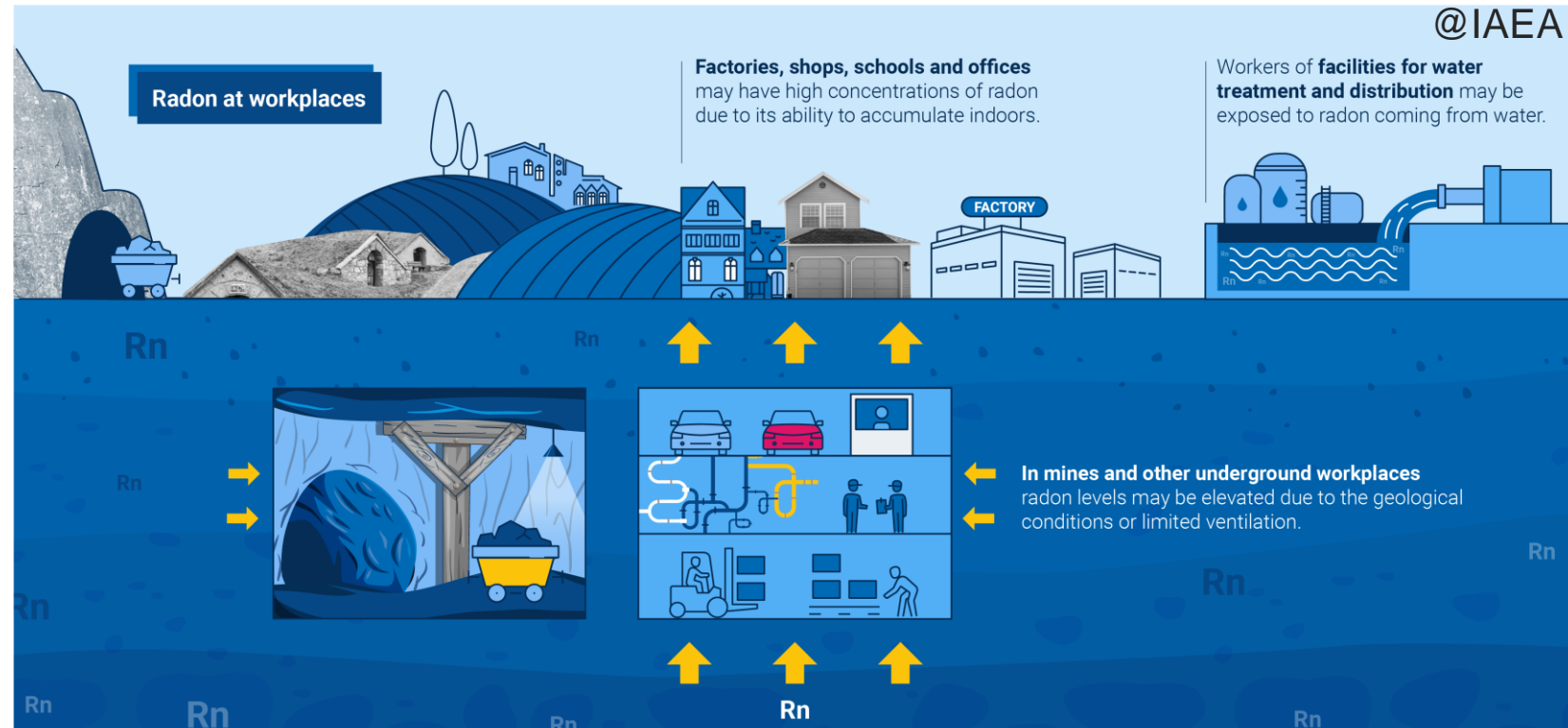

NuclearExplained

# Radon and risk evaluation – 1

- Radon mapping is a first key information for public and worker in order to know if we are in a radon area
- We can find many maps from different countries from different institutes
- It results from several works
  - deduction of the radon emanation by knowing the composition of the ground and its permeability
  - measurements carried out in various points, for example in France in each town hall or school of various villages and cities

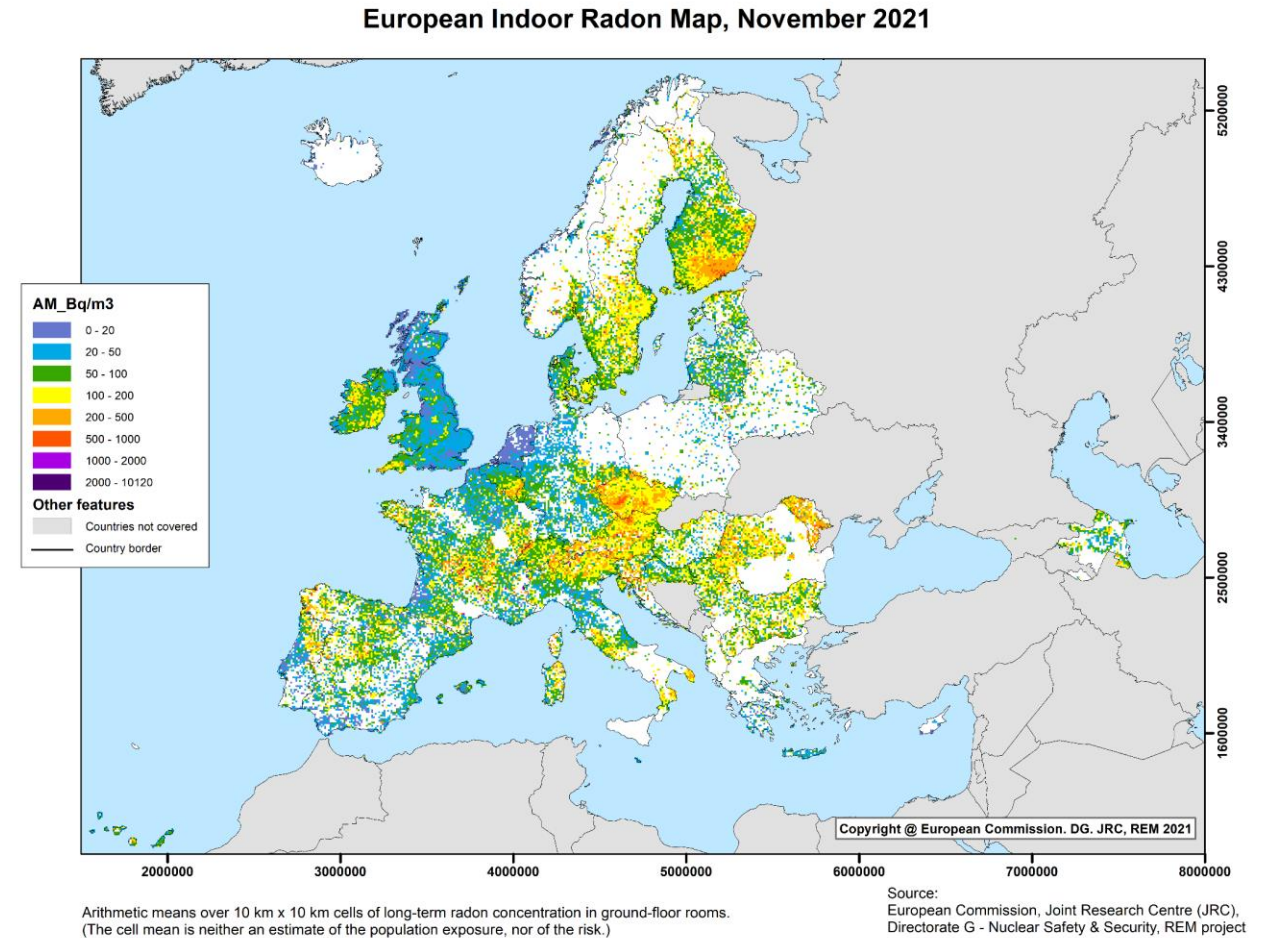

# Radon and risk evaluation – 2

- In the end, these maps are set up for information, as individuals to set up a more accurate estimation of the radon concentration in their homes
- Some countries, such as France, will require the radon risk of a house to be presented when it is sold
- There is no obligation to measure radon in all the countries, however it is the necessary step to check if the radon problem is present and if it can be corrected or not
- Many solutions are commercially available and were developed to perform such measure and even to reduce the radon exposition such as ventilation in old houses or protective membrane underneath new buildings

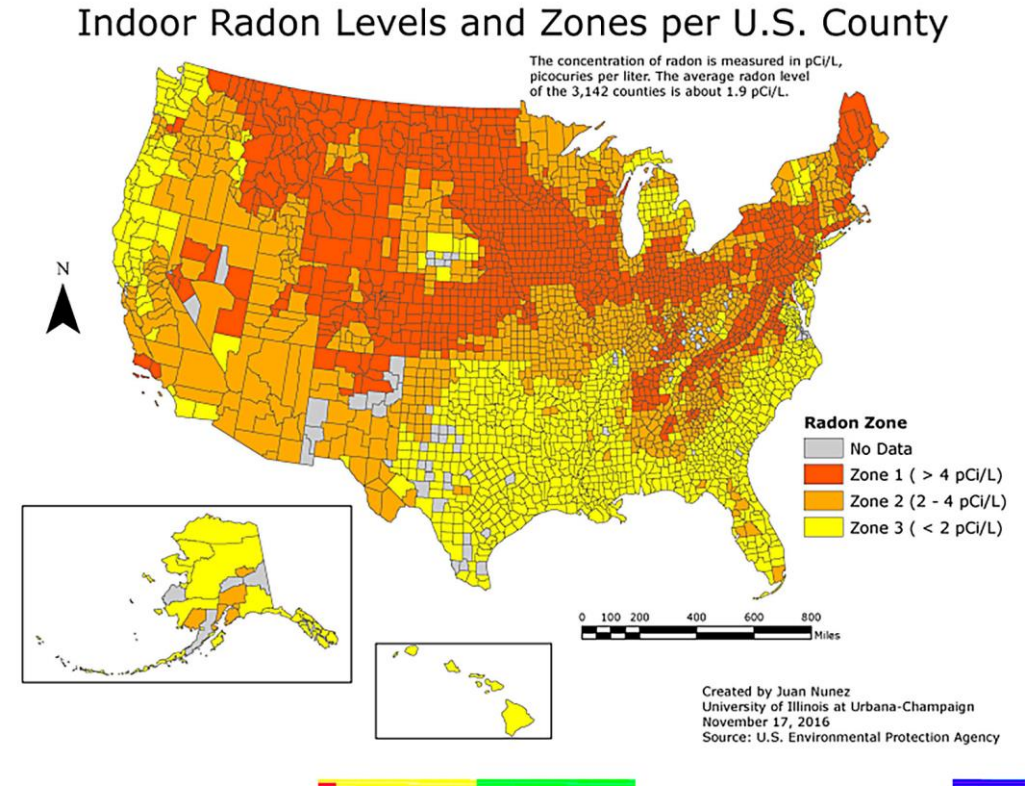



# Radon measurements technologies

- A first set of detectors which are commercially available are active detectors
  - A large variety of instruments for various applications
  - For low to high activity concentration: some Bq·m<sup>3</sup> to MBq·m<sup>3</sup>
  - Different type of sensors: semiconductor such as silicon, ionisation chamber, scintillation flask, inorganic scintillators...

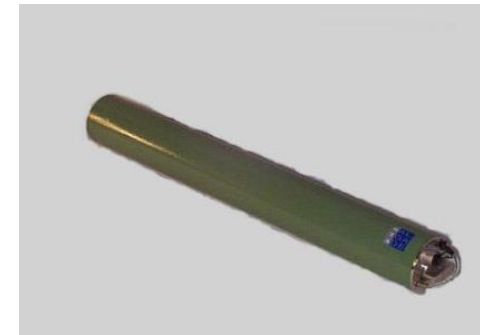

# Radon measurements technologies

- Active detector can be old but working well and some are very modern with wireless connexion and data acquisition on web server...
- However the price is high
  - Not acceptable for public for a simple identification of radon risk
- Passive detectors: cheaper, not precise but good for radon risk identification

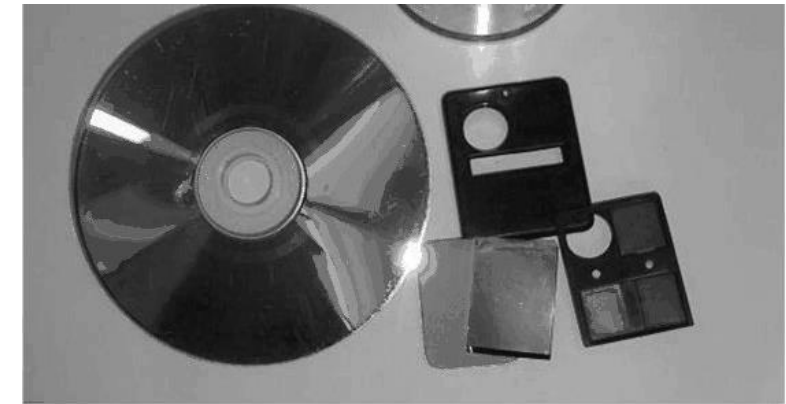

Based on solid-state nuclear track detector (SSNTD)

Based compact disc for retrospective radon measurement  
Dimitrova I., Pressyanov D., Georgiev S., Yankov P., Logistic of surveys of retrospective radon concentrations by home stored CDs/DVDs. Radiat. Prot. Dosim. 145, 300–304 (2011)

# Radon measurements technologies

- All these techniques need calibration for the different radon isotopes
- Several aspects must be taken into account
  - Detection efficiency of the device to be calibrated
  - Linearity of the device, volume activity range dependency
  - Time response
  - Response with mixed radon/thoron atmosphere
  - Dependence of the response on temperature, pressure and humidity conditions...
- In order to assess properly these aspects, radon activity or activity concentration standards have to be developed
- In this webinar we will focus on standards developed for radon metrology and calibration technique that can be used



# 2 Primary standards for radon

First one from NIST – emanation liquid source of  $^{226}\text{Ra}$

# Uranium-238 decay chain

- $^{222}\text{Rn}$  is coming from  $^{238}\text{U}$  with direct father as  $^{226}\text{Ra}$  (half-life ~1600 y)
- $^{222}\text{Rn}$  is an alpha emitter that decays into the alpha and beta emitting isotopes of lead, bismuth and polonium
- $^{222}\text{Rn}$  reaches equilibrium with  $^{214}\text{Po}$  within 4 h and generally we can consider only the following nuclide for measurement (main branch):
  - $^{222}\text{Rn}$  ( $\alpha$ ),  $^{218}\text{Po}$  ( $\alpha$ ),  $^{214}\text{Pb}$  ( $\beta$ ),  $^{214}\text{Bi}$  ( $\beta$ ) and  $^{214}\text{Po}$  ( $\alpha$ ) and of course many gamma emissions
  - $^{210}\text{Po}$  is often a problem for radon measurement as it is a long half-life alpha emitter just in the region of radon and that contaminates the detector

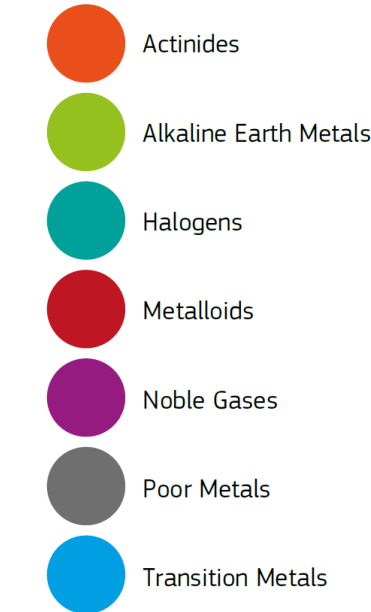
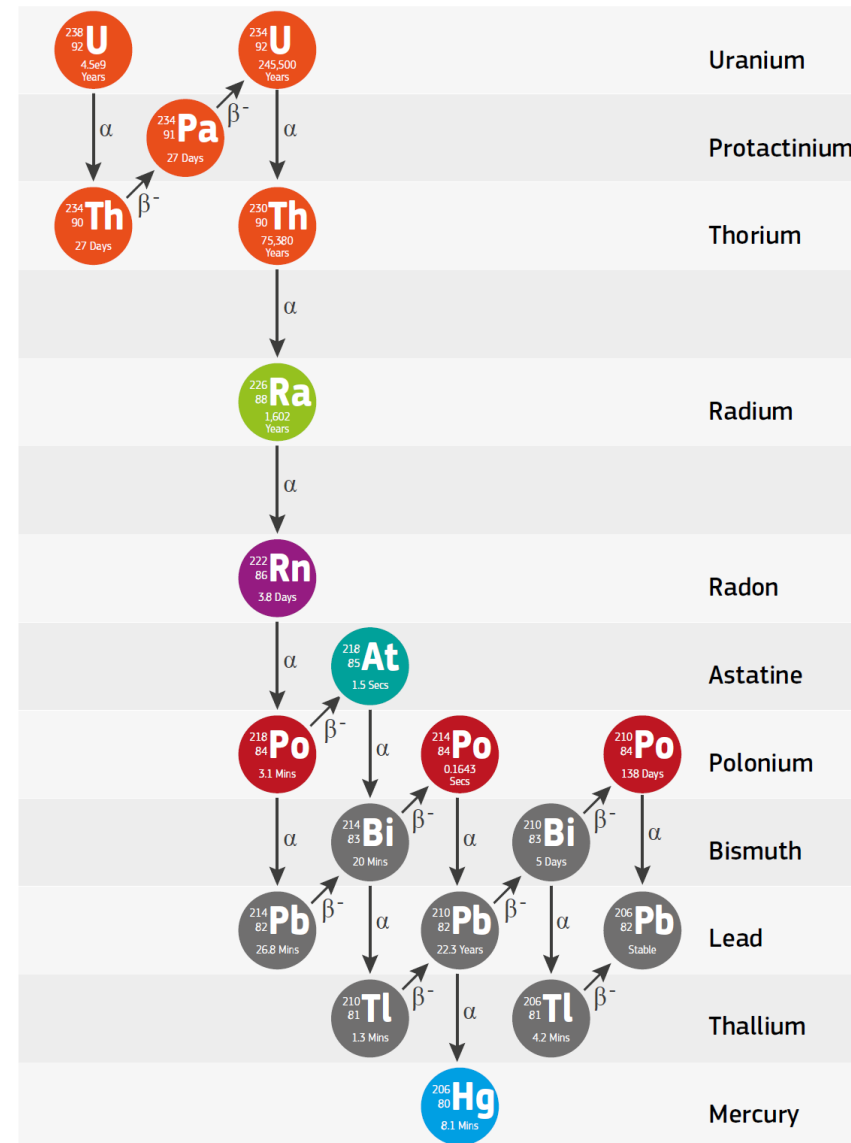

@JRC

# Radon standard – the first technique from NIST

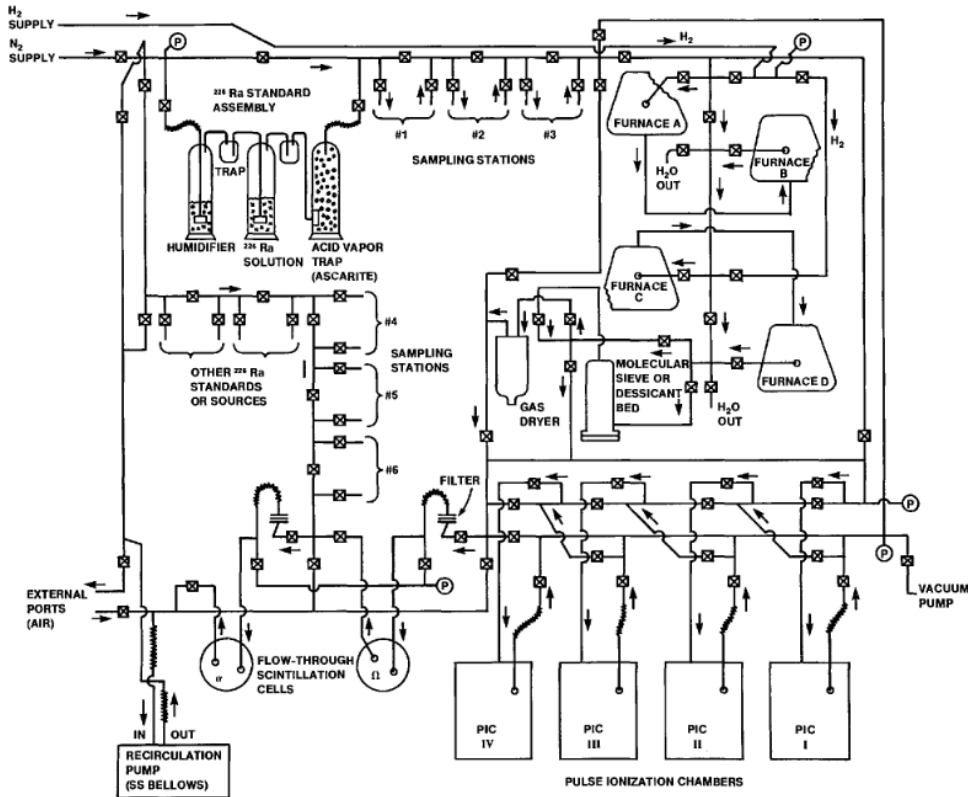

A simplified schematic of the NIST primary radon measurement system illustrating its major components and principle of operation.  
 R Collé, et. al., The NIST primary Radon-222 measurement system (1990) J. Res. Natl. Inst. Stand. Technol. 95, 155

- The first radon standard was developed at NIST in 1990
- The radon production was based on a  $^{226}\text{Ra}$  standard solution to generate known quantity of  $^{222}\text{Rn}$
- The generated activity was checked by using pulsed ionization chamber

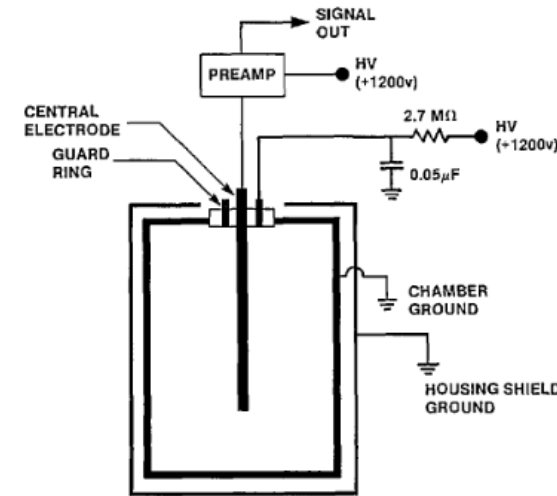

# Radon standard – the first technique from NIST

- One of the difficulty of this system was the complex process due to  $^{226}\text{Ra}$  solution handling
- This system requires the trapping of acid vapors from the radium solution
- A purification system was also needed to remove the water:
  - Furnace at  $600^\circ\text{C}$
  - Quartz tube with reduced copper gauze
- The generated activity was checked by using pulsed ionization chamber and it is « destroyed » in vent
- The calibration process of radon was then using the  $^{226}\text{Ra}$  solution with known emanation

## STANDARD / SAMPLING MANIFOLD

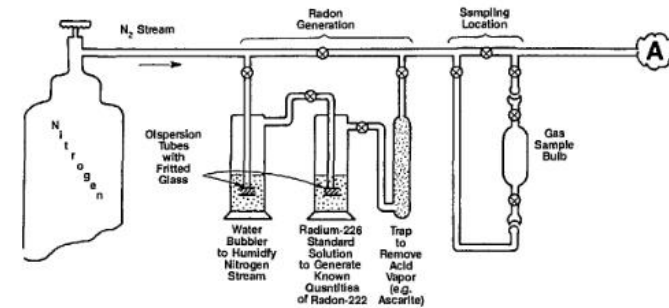

## PURIFICATION SYSTEM

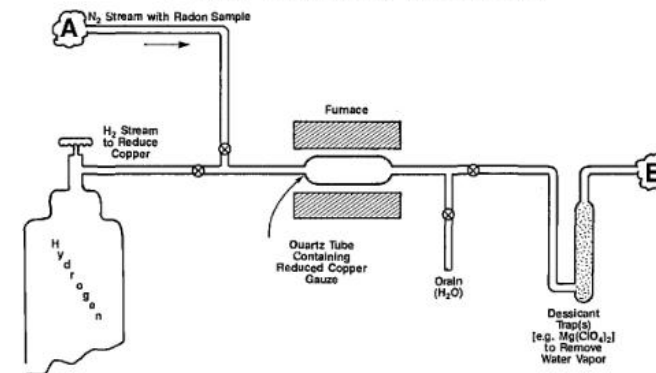

## CHAMBER & COUNTING SYSTEM

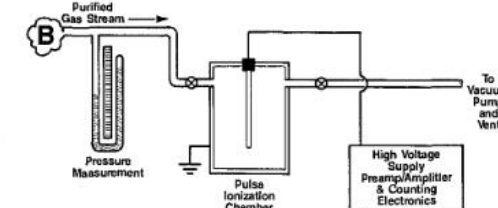

J. Res. Natl. Inst. Stand. Technol. 95, 155 (1990)



# 3 ■ Primary standards for radon

Second one from CEA/LNHB – direct measurement of radon standard and transfer



# Primary radon standard with direct measurement

- The original method for radon primary standard was developed in 1995 at LNHB
  - J.L. Picolo, Nuclear Instruments and Methods in Physics. Res. A 369 (1996), 452–457
- Use alpha spectrometry and defined solid angle DSA method to perform radon primary standard
  - Radon emits alpha radiations
  - Radon half-life is long enough to produce standard
  - Radon is a gas but the DSA method requires a solid source
- Prototype of the method in 1995, upgraded in 2012, the one presented here
  - B. Sabot, et al., Applied Radiation and Isotopes 118 (2016) 167-174

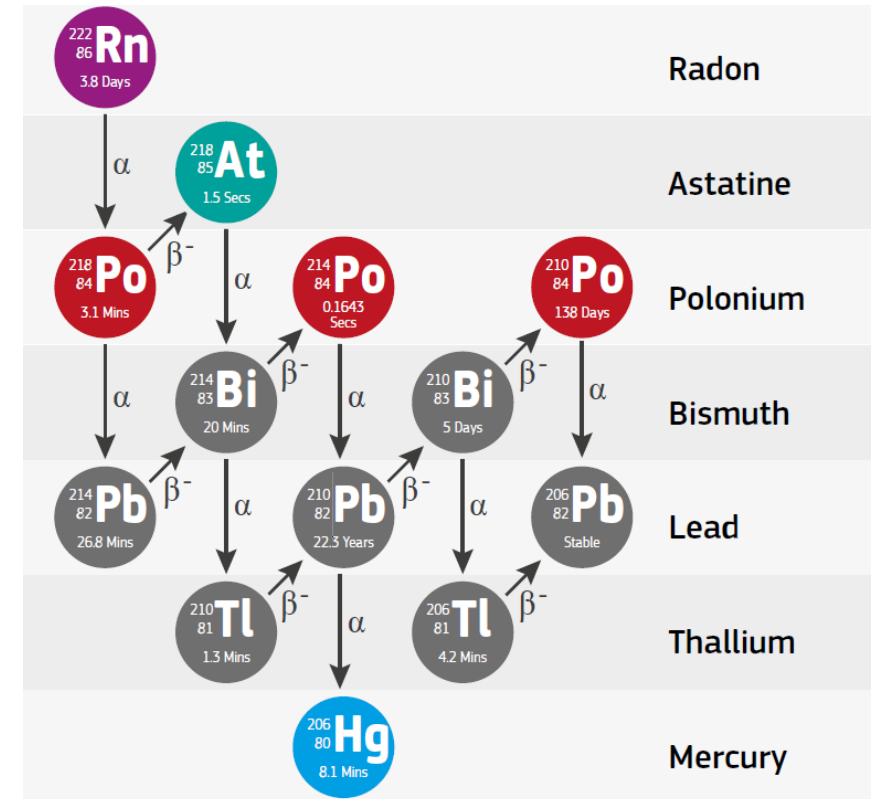

# Defined solid angle method (DSA)

- The emission of alpha particles is isotropic, assuming that:
  - the alpha particles passing through the collimator are counted
  - every alpha particle reaching the detector is counted
  - The detection efficiency of the measuring system is simply equal to the geometry factor  $G$

$$G = \frac{\Omega_{eff}}{4\pi} \text{ where } \Omega_{eff} \text{ is the solid angle}$$

- The activity of the measured source is then given by:

$$A = \frac{\text{counting rate}}{G}$$

- Well known technique for primary measurement of alpha sources
  - S. Pommé, (2015) Metrologia 52 S73

→ Requires a solid source of radon!!

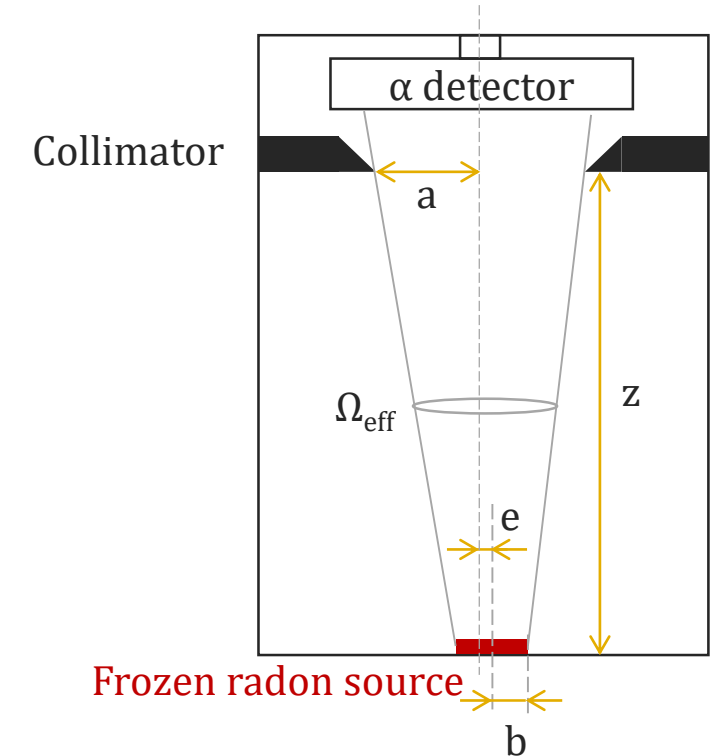

# The setup – Part 1: radon production

- The measurement system is divided in 3 parts all under vacuum

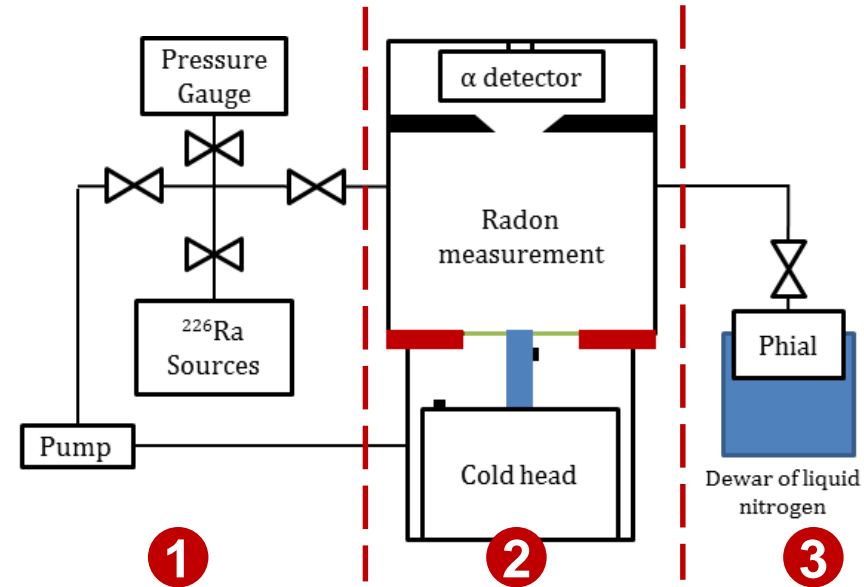
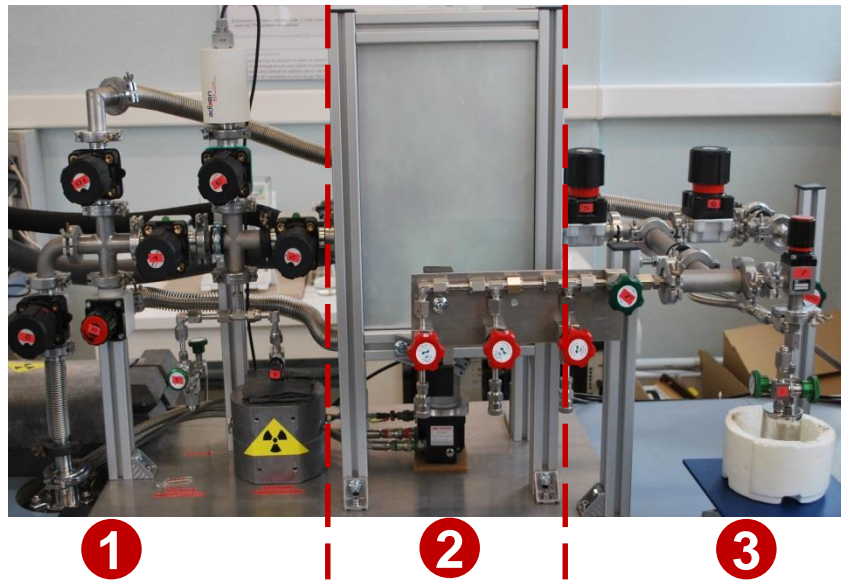

- $^{222}\text{Rn}$  produced by a solid  $^{226}\text{Ra}$  source (512 kBq and 3.6 MBq in our case)
- Control of the pressure; system under vacuum ( $10^{-6}$  hPa), Vacuum pump line
  - After the vacuum is reached on the solid source, the desired activity is obtained by waiting the decay of  $^{226}\text{Ra}$  and radon production (maximum is obtained within ~20 days)

# The setup – Part 2: the measurement chamber

- The key to this system is to be able to freeze the radon at the surface of a metal cold spot
- This is what we call the "cold finger" which makes the device special
  - It is made of stainless steel disc soldered on a nickel rod
  - The nickel rod is connected to a cold head (can reach down to 40 K)
  - The edges of the stainless steel disc are connected to a copper disc heated to 293.15 K
- All the chamber is under vacuum, the cold head and the measurement chamber are separated by the stainless steel disc

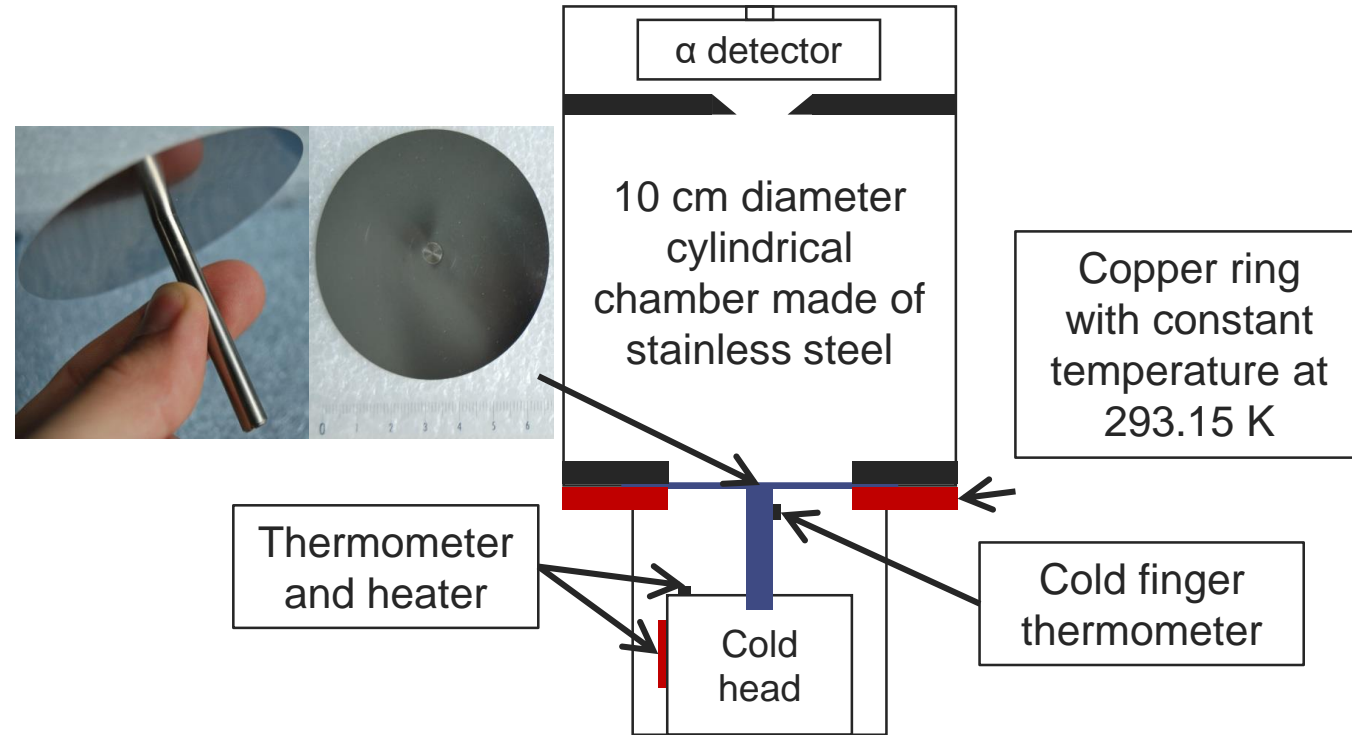

# The setup – Part 2: the measurement chamber

- The key is to freeze the radon at the cold finger surface
  - With the literature it has been possible to extract an idea of the temperature at which radon solidifies in a vacuum
  - Below 100 K it is possible to have solid radon under our pressure conditions (best  $10^{-6}$  hPa)

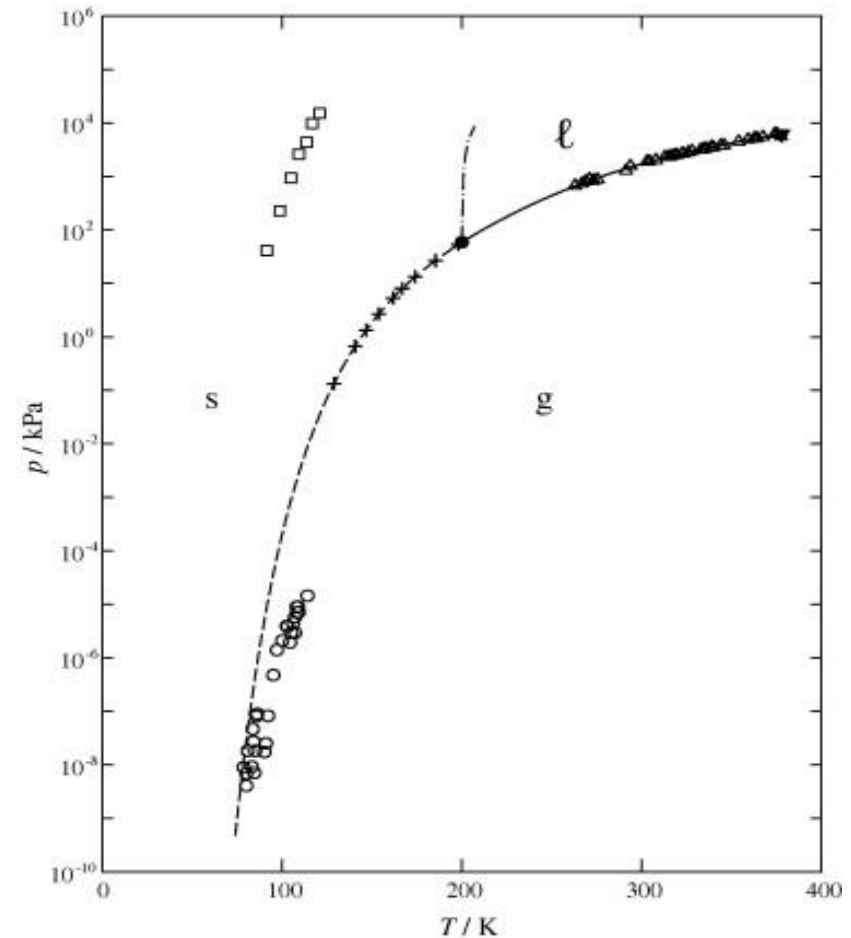

Phase diagram of radon, (A.G.M. Ferreira, 2007)

# The setup – Part 2: the measurement chamber

- With material properties and multiphysics finite element simulation tools we can simulate the thermal behavior of the cold finger and optimise its operating temperature
  - Too low is not good as we may have a larger source
  - Too high we may have gaseous radon
- The compromise was found at 80 K

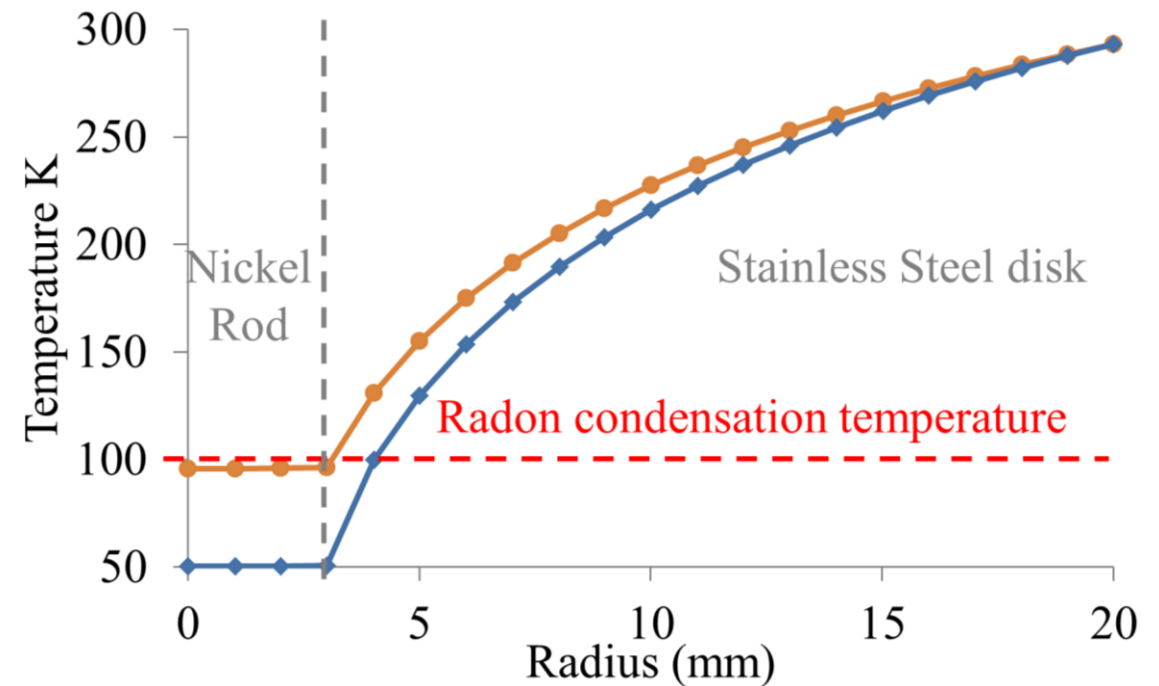
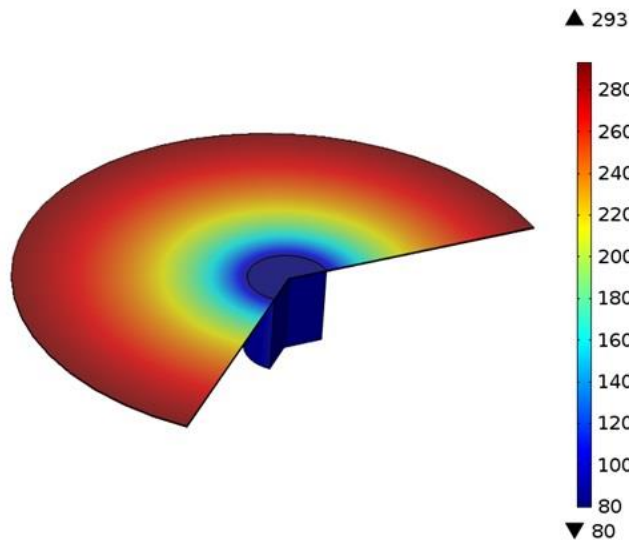

# The setup – Part 2: the measurement chamber

- From this simulation we can deduce the estimate radius of the solid source (here 3.23 (13) mm)
  - This radius can also be measured with imaging plate
- The radius uncertainty contribution is reduced by maximizing the distance between the source and the collimator
- This distance will change with thermal deformation
  - Expected deformations are estimate with multiphysics simulation in order to find the best way to link the cold finger to the cold head generator: to use a copper braid to release the stresses (results 20  $\mu\text{m}$  distance variation)

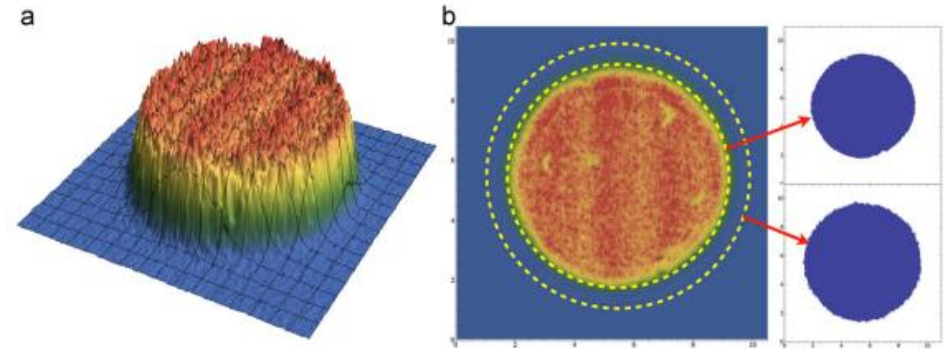

Radon deposition on the tip of the cold finger,  
(Kim et al. 2012 Applied radiation and isotopes 70 pp 1934-1939)

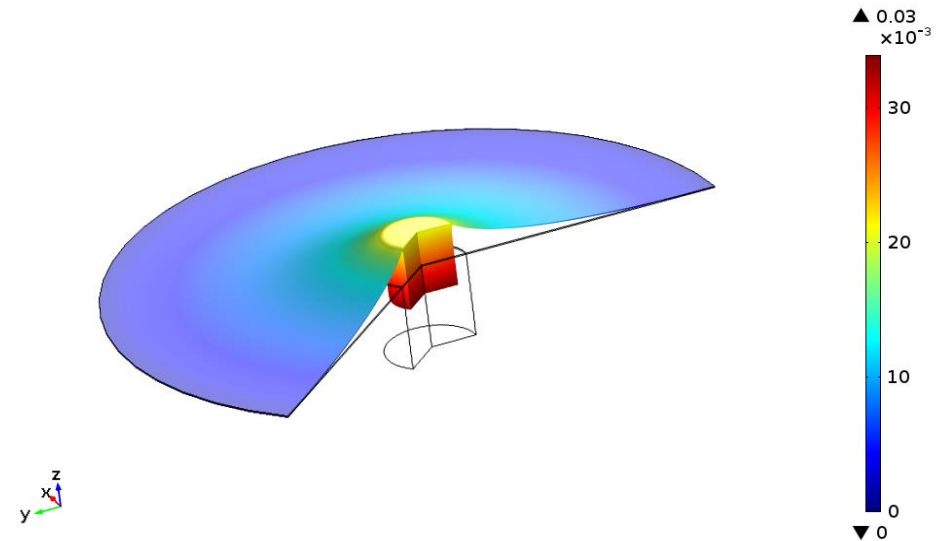

# The setup – Part 2: the measurement chamber

- We can then obtain the solid angle of our system
  - $z = 100.12$  (14) mm; its uncertainty includes the contributions of the length measurement, the imperfect flatness of collimator and collimator support, and the cold finger deformation which has been evaluated by Comsol Multiphysics simulation;
  - $a = 9.0277$  (11) mm; its uncertainty includes the contributions of the length measurement and shape defects;
  - $b = 3.23$  (13) mm; the effect of source radius variation on the geometry factor  $G$  can be calculated. For example, a variation of 1 mm of the source radius involves a variation of  $G$  of 0.05%. The high  $z$  value minimizes this effect;
  - $e < 1$  mm. Taking  $e = 1$  mm instead of 0 mm leads to a variation of  $G$  of 0.015%; since  $e$  is much smaller than 1 mm, this parameter is negligible.
- $G = 2.019 \cdot 10^{-3}$  with a relative standard uncertainty of 0.28%.

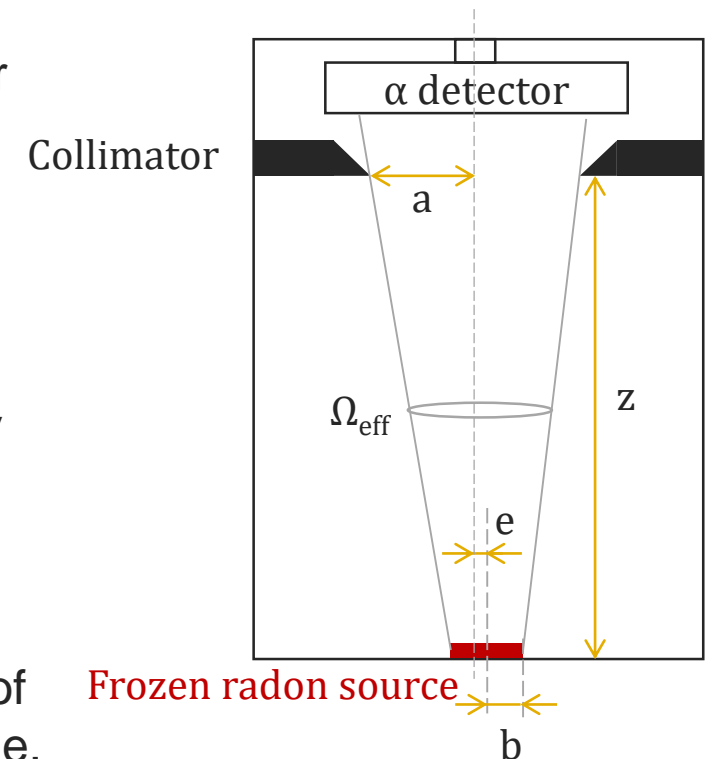



# The setup – Part 2: the measurement chamber

- But how can we be sure that radon is frozen, what if we have a problem ? Thanks to the physics that help us in this case !
  - The system here provide a very thin source which is composed of  $^{222}\text{Rn}$  atoms and some other remaining gas from the vacuum chamber: it provides very good spectrum without big left tail as other alpha sources
  - This spectrum quality allows us to differentiate solid radon from radon gas visually on the spectrum

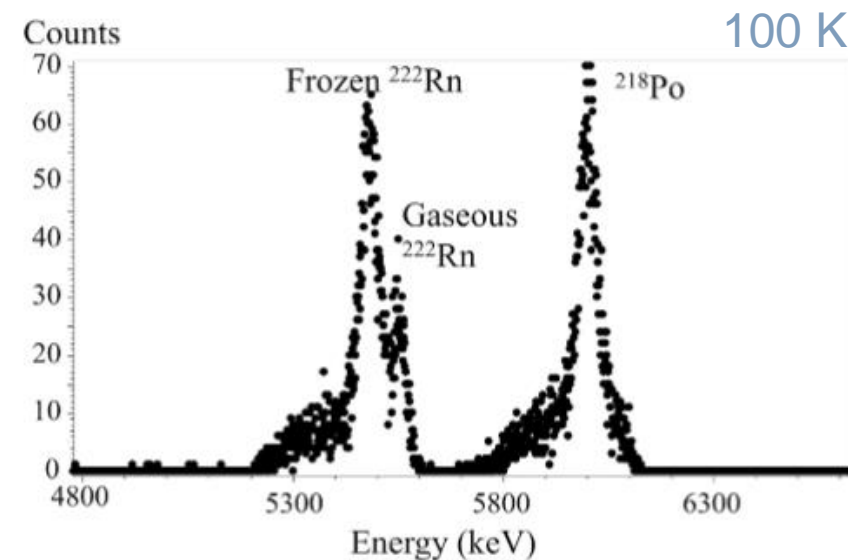
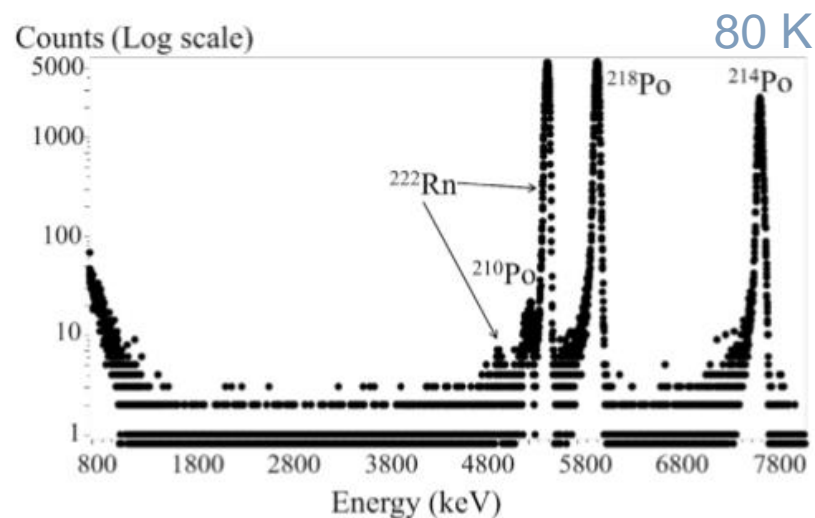

# The setup – Part 3: transfert of the $^{222}\text{Rn}$ primary standard

- The standard can be transferred into a glass or metal container using liquid nitrogen bath
- Activity of the primary standard 100 Bq up to 4 MBq with a relative standard uncertainty of 0.3% (ISO 17025 - COFRAC)
- Can be used by any other laboratory for calibration; just a vial sent in a package

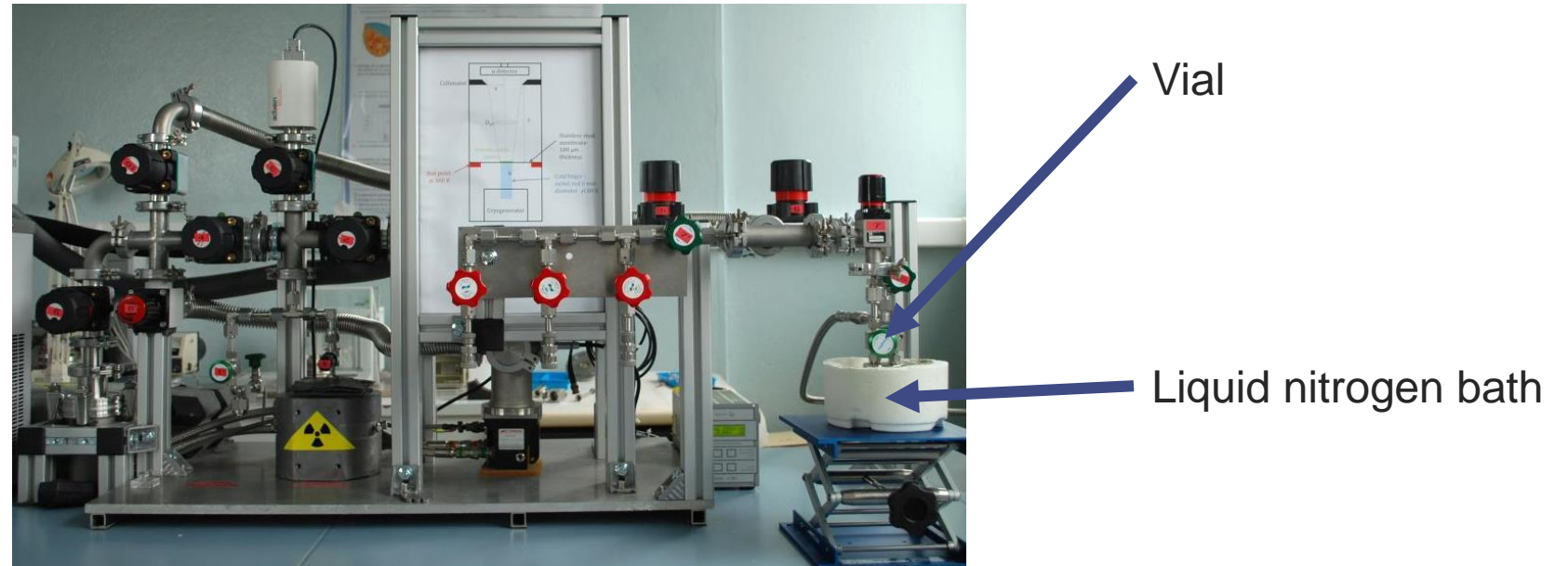

# The setup – Part 3: transfert of the $^{222}\text{Rn}$ primary standard

- The system presents a good linearity, there is no loses of radon during the transfer that can be totally done into a vial within 30 min as shown by a very good reproducibility of the measurements
- The standard can be done within half a day and sent immediately
- One limitation: with time the cold finger is contaminated with  $^{210}\text{Po}$  changing the detection limit, it can't be cleaned, however it can be changed
- Different International comparisons were performed with other national metrology institutes (CCRI-II: China, Korea, Italy, Switzerland, PTB, Romania, ...)  
→ Useful radon standard that can be sent all over the world thanks to radon half-life

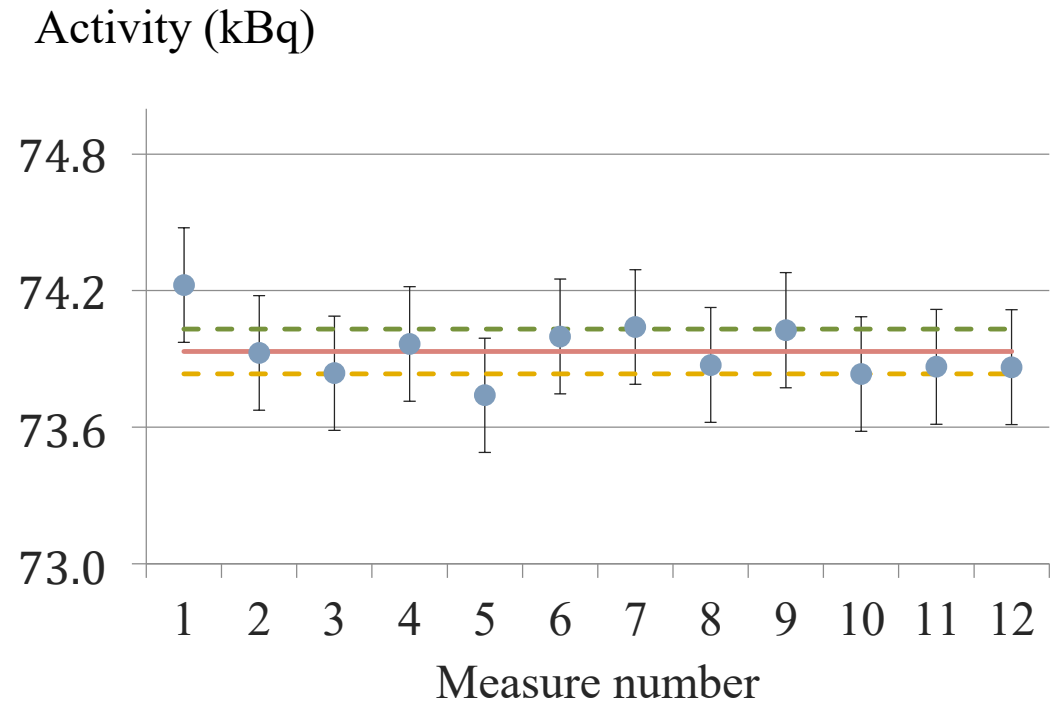

# Radon primary standard in the world

- This DSA technique with frozen source of radon can be easily implemented in other National Metrology Institut (NMI) like it has been done with nice collaboration with other colleagues





# 4. SIR for $^{222}\text{Rn}$ and international traceability

# International Reference System, SIR

- The international measurement system for radionuclide metrology relies on primary standards realized at national metrology institutes or designated institutes.
- The BIPM offers services to demonstrate equivalence of these primary standards. The services are easy to use and reduce the need for complex large-scale comparison exercises
- The SIR is using an ionization chamber; in the case of radon, we can transfer into a glass vial provided by BIPM a standard of radon gas. However this is not applicable to radon due to significant effect of carrier gas, glass wall thickness, sealed point...
  - S. Pierre, et al, Bias in the measurement of radon gas using ionization chambers: Application to SIR, (2018) Applied Radiation and Isotopes, Volume 134, Pages 13-17

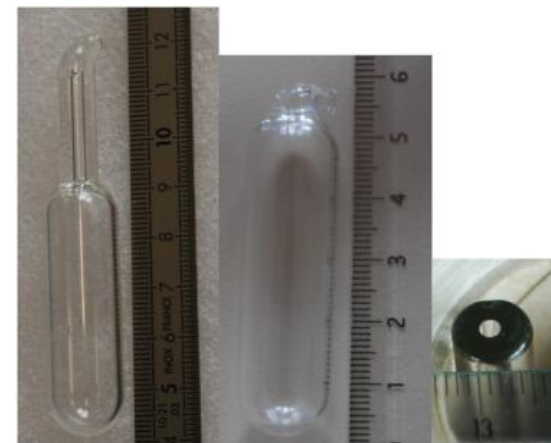
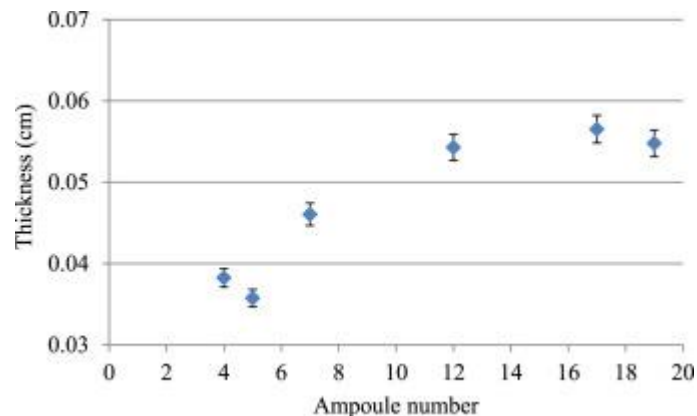

# International with many comparisons

- The only remaining solution was different international comparisons with a specific methodology involving the production of many radon samples from the same source sent to other NMI:
  - S. Pierre, P. Cassette, B. Sabot, C. Fréchou, A. Antohe, C. Barna, P. Blahušiak, F. Cardellini, R. Dersch, A. Honig, F. Juget, M. Krivošík, A. Luca, F. J. Maringer, F. Mertes, S. Röttger, M. Sahagia, J. Slučiak, M. Stietka, L. Szűcs, C. Teodorescu, (2021) International comparison of activity measurements of radon 222, EURAMET Project n°1475 – EURAMET.RI(II)-S8.Rn-222, Metrologia 2021 58 Tech. Suppl. 06015
- Or smaller comparison like between NIM (China), IRA-METAS (Switzerland) and LNHB (France):
  - S. Pierre, F. Juget, J. Liang, P. Cassette, C. Fréchou, B. Sabot, International comparison of activity measurements of radon 222, CCRI(II)-S14-Rn-222
  - In this comparison we have seen that it is possible to transport the same sample between different laboratories but that this implies a slight cumulative loss of 0.6% of the activity after 4 measurements

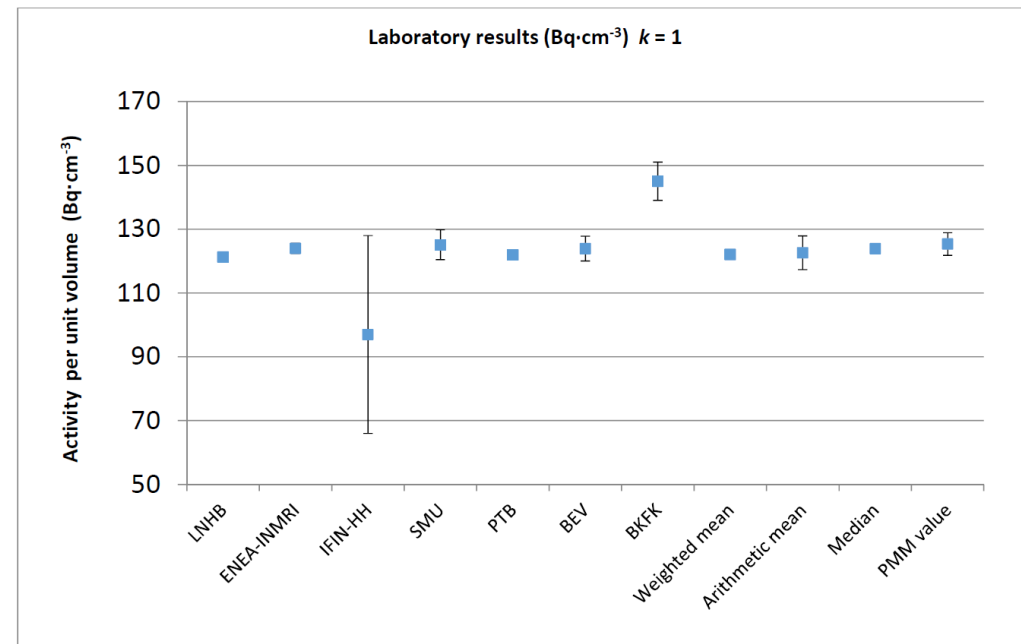



# 5 ■ Calibration with radon

Primary calibration



# Calibration of radon sensors

- The calibration of radon measurement instruments requires a specifically dedicated gas bench and therefore the complexity will depend on the objectives sought



B. Sabot, et al. Experimental facility for the production of reference atmosphere of radioactive gases (Rn, Xe, Kr, and H isotopes), (2020), Applied Radiation and Isotope 155

# Calibration with primary standard – method

## General method

- Radon gas decaying method
  - Create a reference atmosphere (IEC 61577)
  - The instrument to be calibrated is placed in an airtight volume (the volume is  $V_{ch}$ )
  - At a time  $t_0$ , the  $^{222}\text{Rn}$  is injected
  - $^{222}\text{Rn}$  volume activity decay in the volume according to decay of radon

$$A_v(t) = \frac{A(t_0)e^{-\lambda t}}{V_{ch}}$$

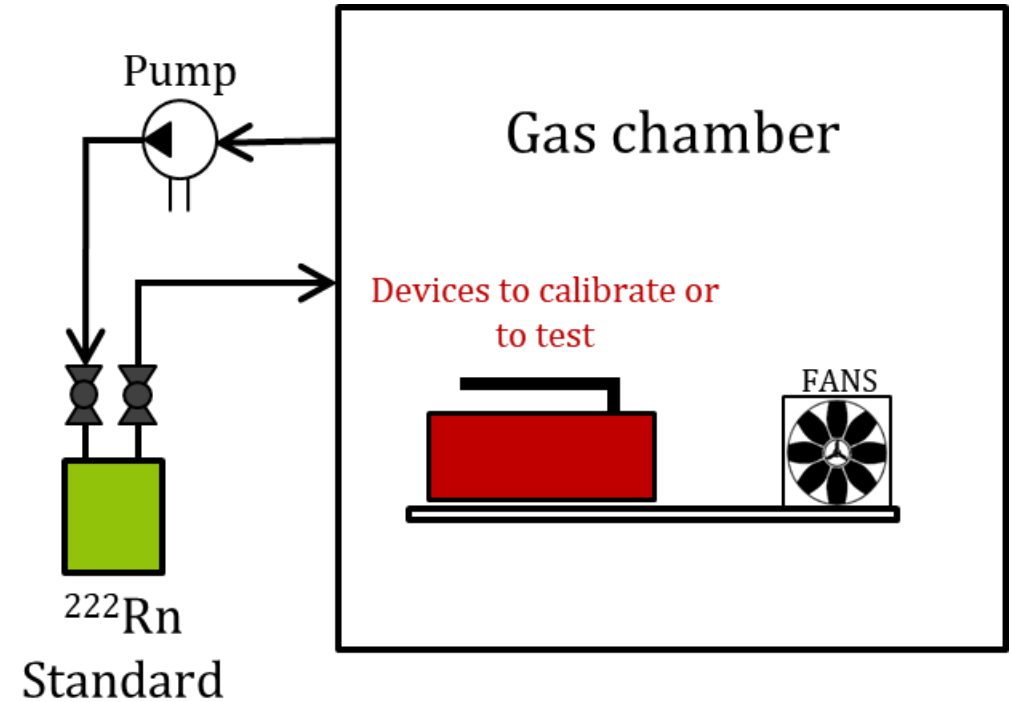

# Calibration with primary standard – method

Volume measurement technique under vacuum

- $V_{ref}$  is filled with nitrogen at  $P_{ref}$  and  $T_{ref}$ , the rest of free volume is under vacuum.
- We open  $V_{ref}$  valve and we have new measurements  $(P_1, T_1)$ :

$$\frac{P_{ref} V_{ref}}{T_{ref}} = \frac{P_1 V_1}{T_1}$$

- As  $V_2 = V_1 + V_{ch}$ , we do the same procedure than before and we obtain:

$$V_{ch} = \left( \frac{T_2}{P_2} - \frac{T_1}{P_1} \right) \frac{P_{ref} V_{ref}}{T_{ref}}$$

- With associated uncertainty
- It can also be done without vacuum with a 2 times larger uncertainty

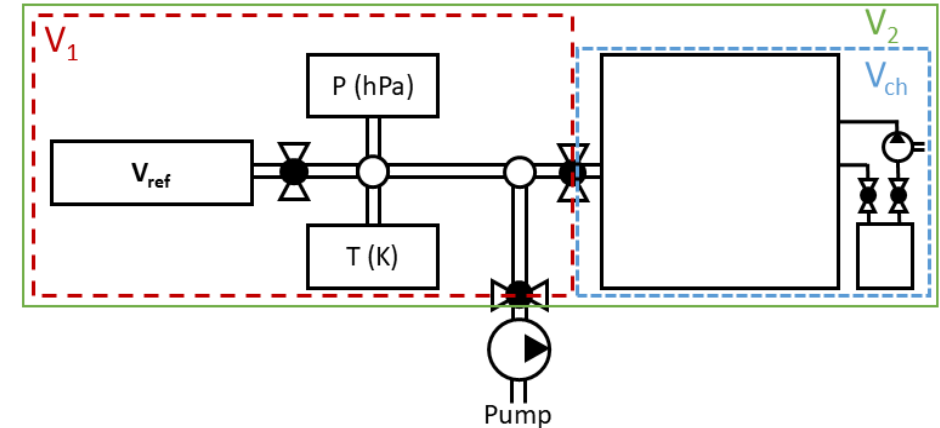

Typical uncertainty budget for a volume measurement at CEA/LNHB

Quantity	Measured value with uncertainty	Contribution
$P_{ref}$	1 987.65 (5) hPa	0.02
$V_{ref}$	2 223.6 (1) cm <sup>3</sup>	0.09
$T_{ref}$	294.19 (10) K	4.78
$P_1$	1 854.57 (5) hPa	0.01
$T_1$	294.32 (10) K	0.01
$P_2$	34.68 (5) hPa	90.07
$T_2$	293.9 (10) K	5.02
$V_{ch}$	124.93 · 10 <sup>3</sup> (19) cm <sup>3</sup>	

# Calibration with primary standard – method

- Compare the expected true value to the instrument results
  - Make sure we match the start time of the measurement instrument, and that time is not drifting with the exposure duration
  - The measurements of the instrument are not instantaneous; to compare the results to the expected true value a reference activity concentration, one needs to take into account the duration,  $\theta$ , of this measurement:

$$A_{v_{ref}}(t) = A(t) \frac{1 - e^{-\lambda\theta}}{\lambda\theta}$$

- For a given time  $t$  and a duration  $\theta$ , the reference radon volume activity is:

$$A_{instrument}(t) = A_{measurement} - background$$

- And we can compare results:

$$R_{instrument} = \frac{A_{instrument}}{A_{v_{ref}}}$$

# Calibration with primary standard – example

- Example of raw data obtained with two kind of devices in BACCARA at IRSN and a primary standard from CEA/LNHB

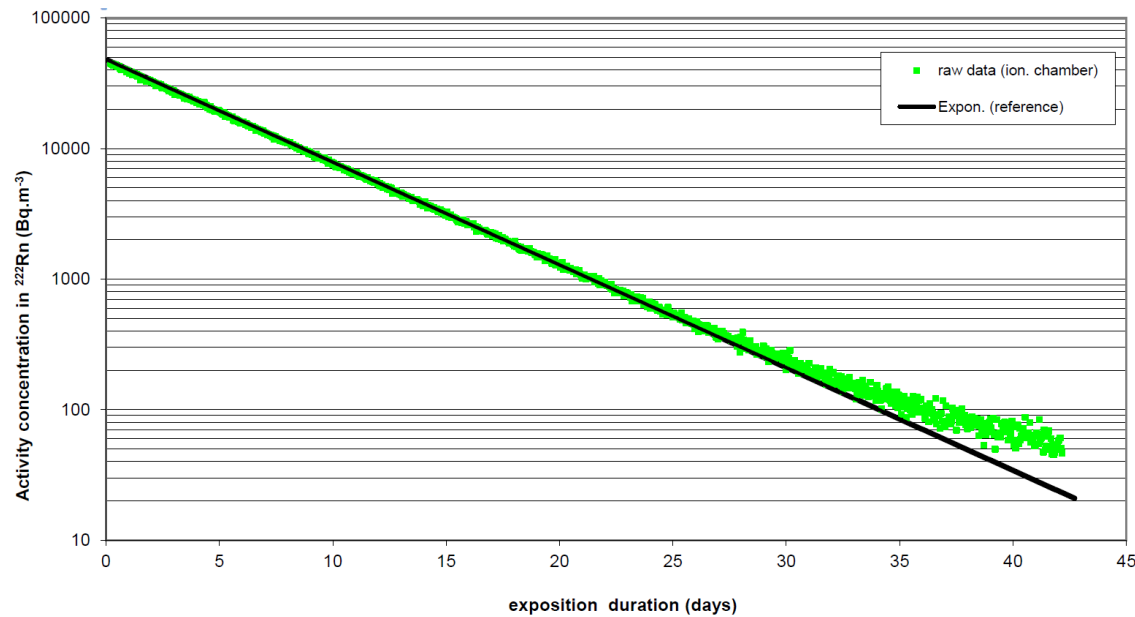

Impact of background with pulsed ion chamber

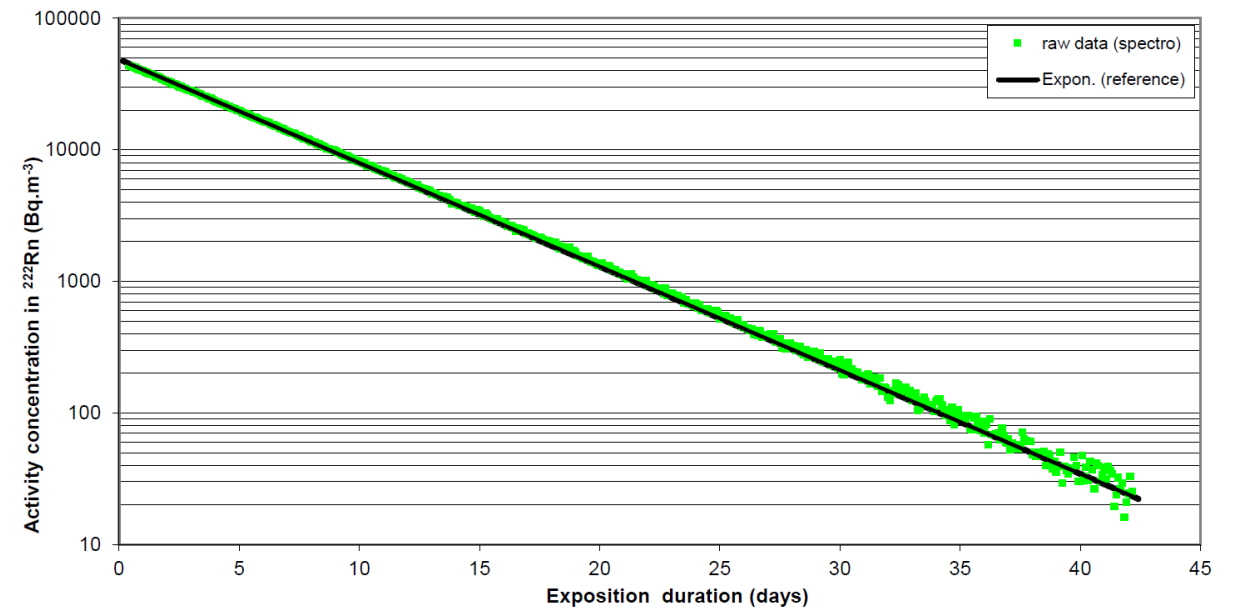

Lower background with spectrometry

# Calibration with primary standard – example

- Example of calculated R with data from BACCARA and radon standard sample

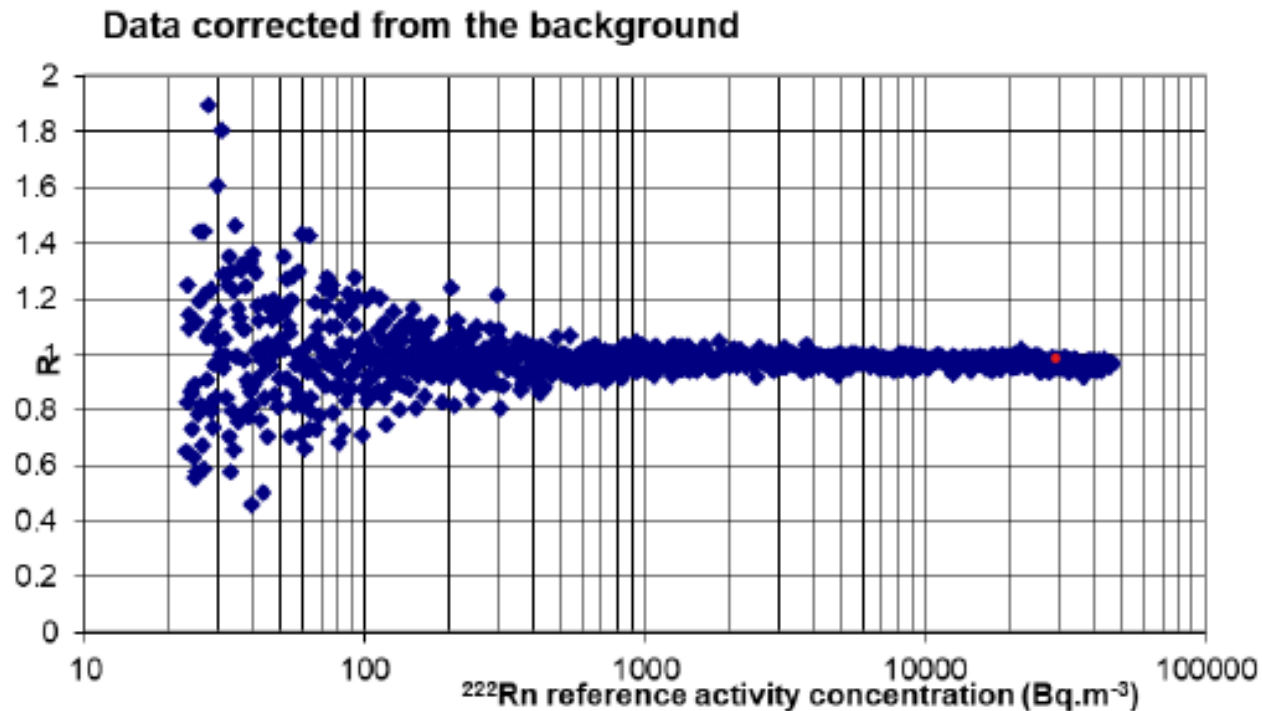

# Calibration with primary standard – reference device

- You might want to be able to calibrate a large variety of instruments for various applications: environment, radiation protection, in building, in workplaces, in soil...
- The range of commercial radon instruments can vary over five or six orders of magnitude: from some  $\text{Bq}\cdot\text{m}^{-3}$  to some  $\text{MBq}\cdot\text{m}^{-3}$
- The choice of reference instrument is difficult and must have:
  - a high sensitivity,
  - a measurement uncertainty lower than the instrument to be calibrated (better sensitivity, better reproducibility of the results...)
  - a linear response with activity concentration over the entire range (or different instruments for different range)
  - a low background
- At the end the best will be to design your own device that you could easily clean for contamination as example of update in case of linearity problem...



# 6 ■ Calibration with radon

Secondary calibration



# Calibration with secondary standard – method

- The basic components and modules consist of
  - a radon chamber or volume where instruments can be placed,
  - $^{226}\text{Ra}$  emanation sources, a carrier and dilution gas (air),
  - a fan,
  - an exhaust pipe,
  - a radon reference instrument traceable to radon primary standard.
- Principle : one (or several) constant and stable  $^{222}\text{Rn}$  activity concentration are established

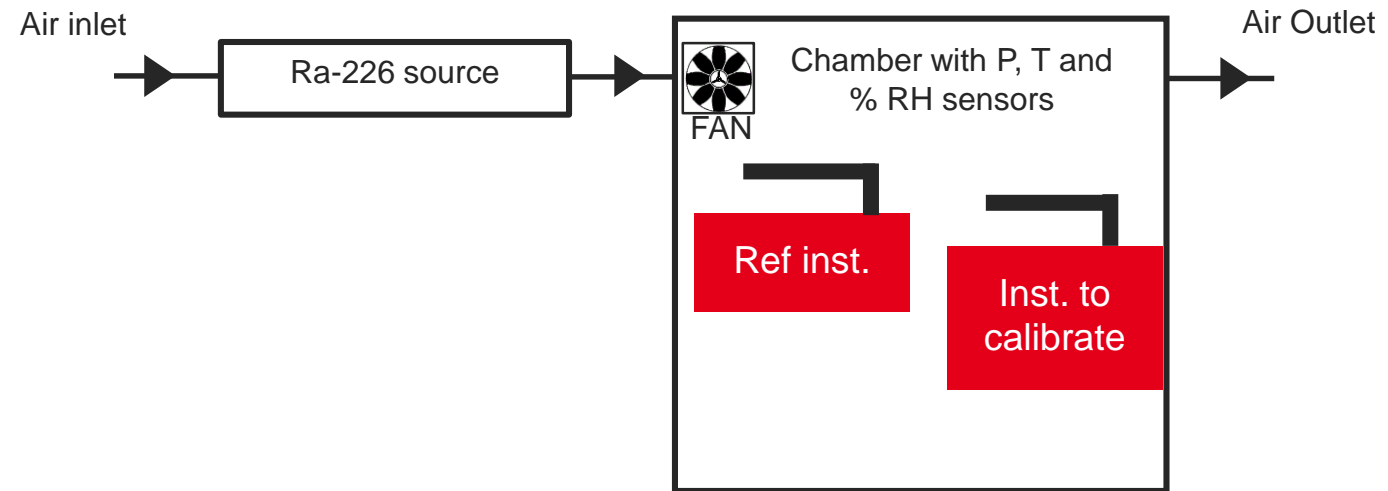

# Calibration with secondary standard – device example

Example at CEA/LNHB: Diagram of the setup; (a) Part is corresponding to the different pipes, filters, dryer, humidifier, radioactive gases production or standardized bottles connected together in order to produce clean and radioactive air. (c) Part corresponding to the 125 L chamber with fans, sensors and possible connections. (d) Part corresponding to the 42 L chamber with fans sensors and possible connections.

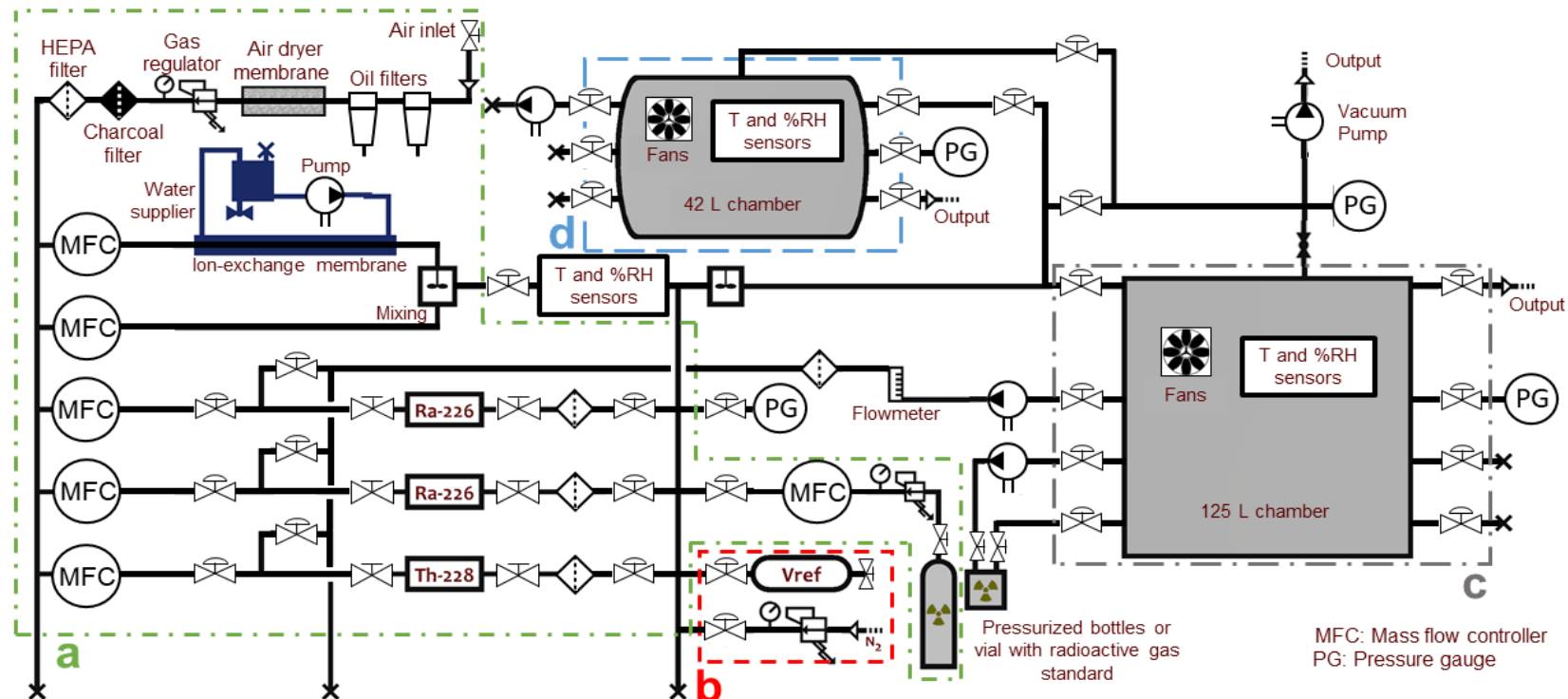

# Calibration with secondary standard – important points

- Stability of the radon concentration inside the vessel should be as good as possible (constant emanation source, beware of some flow rate controllers, radon conc. in the dilution air)
- Homogeneity inside the volume shall be investigated (one or several fans, locations of gas inlet and outlet ...)
  - Simulation or measurements can help to check this point
- Such atmosphere productions are very suitable to study humidity or temperature influence on the instruments
- How many levels of activity concentration ?
  - Depends on the apparatus to be calibrated it is thus important to know the device to calibrate by using the manual when there is one (sensitivity, linearity, time response, ...)
  - Depends also on your chamber capabilities

# Calibration with secondary standard – principle

- The reference  $^{222}\text{Rn}$  activity concentration is determined taking into account the calibration of the reference instruments

$$A_{ref} = \frac{A_{ref. inst.} - background_{ref. inst.}}{R_{ref. inst.}}$$

- Preferably the measured activity is done by the average of multiple points while the activity concentration is stable:
  - Wait for instrument time response, and gather a maximum of counting stat.

- The activity of the instrument to be calibrated is also measured:

$$A_{inst.} = I_{inst.} - background_{inst.}$$

- The comparison is then

$$R_{instrument} = \frac{A_{inst.}}{A_{ref}}$$

# Calibration with secondary standard – comparison

- A reference instrument can travel over different countries for comparison
  - Each facility calibrates the same instrument
  - Comparison of the calibration results
- Previous comparison were organized by PTB, [Röttger et al., 2005, 2006]
- In the framework of the Euramet MetroRADON project 2017-2020 different comparison where performed
  - An alphaGUARD was circulated between facilities
  - Reference atmosphere at 200, 300, 400, 1 000 and 6 000 Bq·m<sup>-3</sup>
  - for more information see <http://metroradon.eu/>

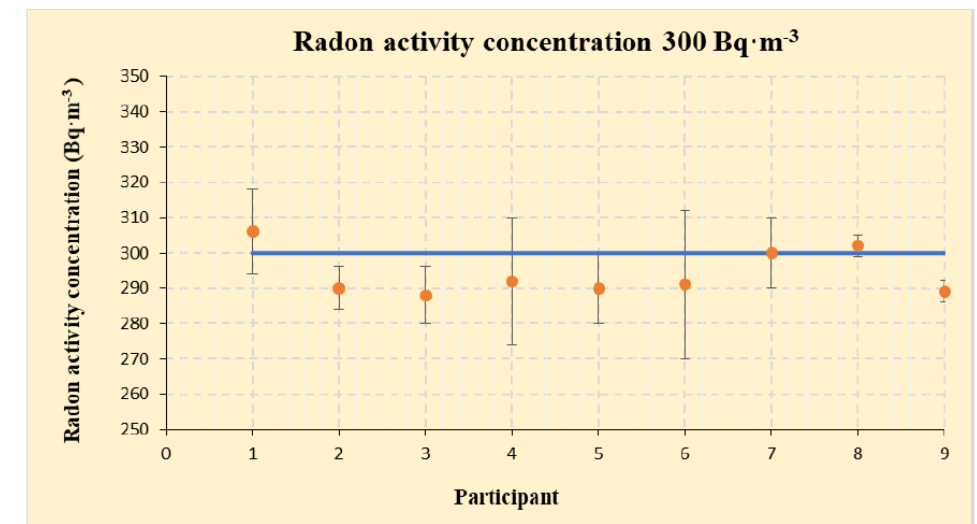
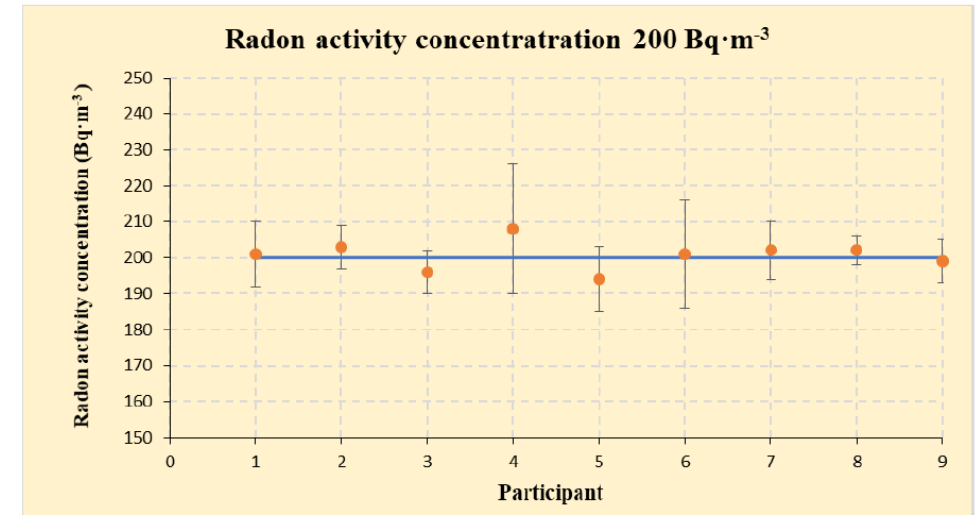



# 7 ■ Primary standards for thoron

Emanation source; PTB

# Thorium-232 decay chain

- $^{220}\text{Rn}$  is coming from  $^{232}\text{Th}$  that has a very long half-life
- $^{228}\text{Th}$  is the closest long half-life nuclide to produce solid source that produce  $^{220}\text{Rn}$
- $^{220}\text{Rn}$  is an alpha emitter that decays into the alpha and beta emitting isotopes of lead, bismuth and polonium same as  $^{222}\text{Rn}$
- Its half-life is very short 55.8 s and thus previously presented technique can't be used for standardization

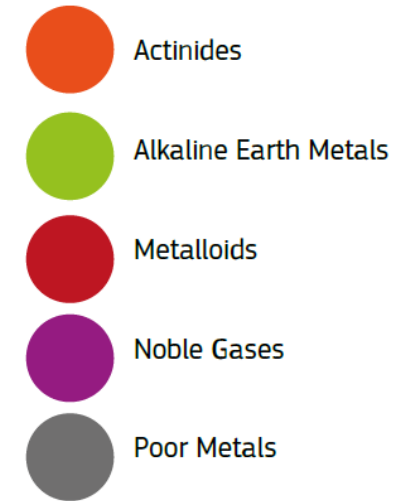
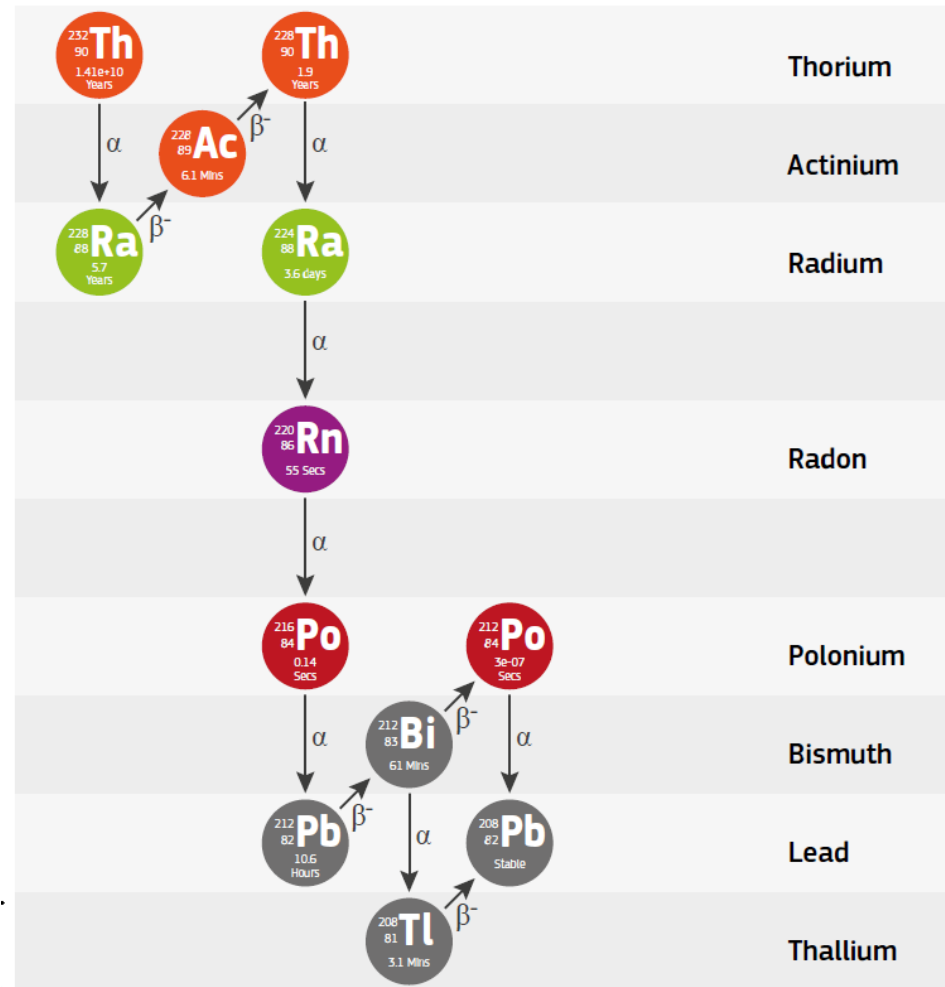

@JRC

# First standard developed at PTB in 2014

- Concept base on a thin source of  $^{228}\text{Th}$  and a calibrated HPGe detector
- This technique use an indirect measurement of the  $^{220}\text{Rn}$  father and daughter to deduce the emanation rate of  $^{220}\text{Rn}$  from a thin plan source

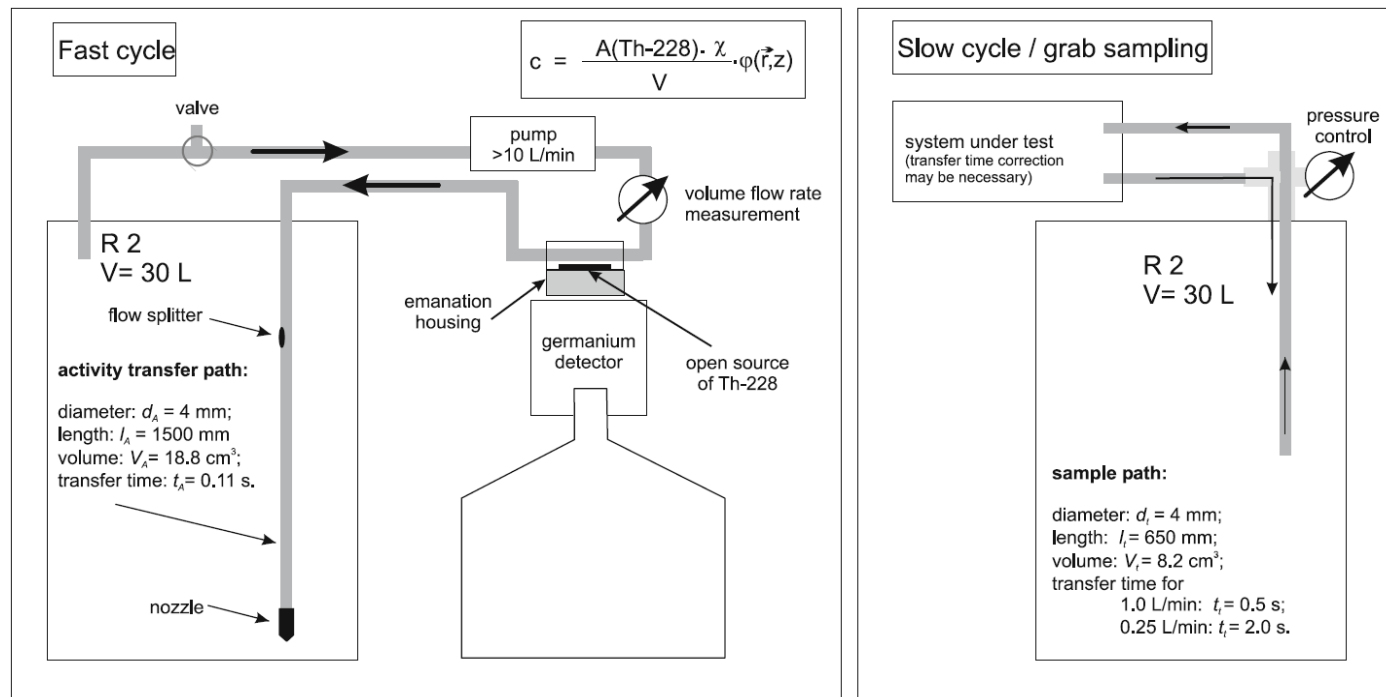

Röttger, et al., 2014



# Calculation method

- The thoron volume activity is determined using the following formula:

$$C_{Tn} = \frac{A_{228Th} \chi}{V} \varphi(\vec{r}, z)$$

- $\varphi(\vec{r}, z)$  is the activity distribution inside the vessel ideally equal to 1

$$\chi = \frac{A_{220Rn}}{A_{228Th}} = 1 - \frac{R_2 A_{212Pb}}{R_1 A_{224Ra}}$$

- $R_1$  and  $R_2$  represent the correction factors due to the activity of the recoil atoms of  $^{224}Ra$  and  $^{212}Pb$ , respectively, deposited outside the plane source

$$\chi = 1 - \frac{\dot{N}_m(^{212}Pb) - \dot{N}_{bg2}(^{212}Pb)}{\dot{N}_m(^{224}Ra) - \dot{N}_{bg2}(^{224}Ra)} \times \frac{p_\gamma(^{224}Ra)}{p_\gamma(^{212}Pb)}$$

Where  $N_m$  are the counting rate in each gamma peak and  $N_{bg}$  the corresponding background with  $p_\gamma$  the emission intensity

# Calculation method and results

- A second approach is used to perform the same kind of calculation but without gamma intensity as input

$$\chi = 1 - \left( \frac{R_2 \dot{N}_k(^{224}\text{Ra}) - \dot{N}_{bg1}(^{224}\text{Ra})}{\dot{N}_k(^{212}\text{Pb}) - \dot{N}_{bg1}(^{212}\text{Pb})} \right) / \left( \frac{R_1 \dot{N}_m(^{224}\text{Ra}) - \dot{N}_{bg2}(^{224}\text{Ra})}{\dot{N}_m(^{212}\text{Pb}) - \dot{N}_{bg2}(^{212}\text{Pb})} \right)$$

- This technique allowed them to determine  $\chi = 0.405$  (14) for their source with dry air.
- The volume activity in  $^{220}\text{Rn}$  is thus measured with a relative standard uncertainty of 3%.
- The largest uncertainty component on the volume activity in the system is related to the homogeneity of the thoron in the volume
- However, this  $\chi$  value is very dependant on humidity and temperature as we demonstrated in the framework of MetroRadon project by comparison tentative between PTB and CEA/LNHB thoron standard



# 8 ■ Primary standards for thoron

Direct measurement; CEA/LNHB

# Principle of reference thoron atmosphere production

- The atmosphere is created using a solid source of  $^{228}\text{Th}$  with stable emanation rate, mixing and different concentration are produced using a constant flow rate circulation in the solid source

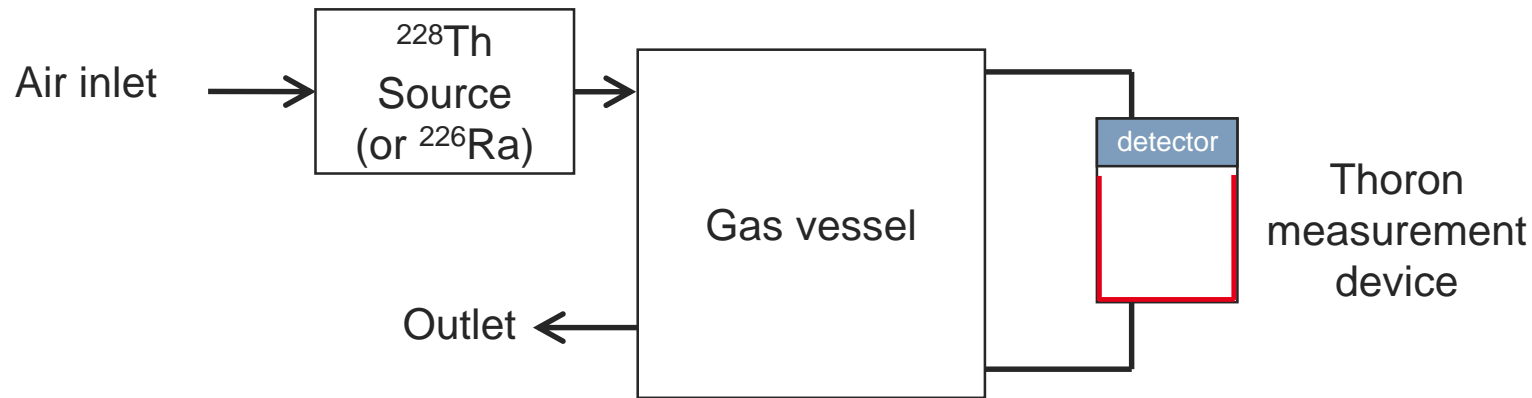

- Creation of a measuring device to ensure the metrological traceability of the  $^{220}\text{Rn}$  atmosphere:
  - Volume using an alpha detector whose detection efficiency is evaluated by Monte Carlo method
  - Allows radon measurement to validate performance calculations
  - Allows identification of the presence of both radon isotopes
  - Transportable device for connection to a chamber producing a thoron reference atmosphere

# Principle of the measuring device

- A filter at the inlet of the volume: it eliminates all the descendants produced upstream of the device
- Measurement volume consisting of a large area alpha detector, a small volume and a high flow rate:
  - Limits the energy loss of alphas in the air Identical
  - Distribution and detection efficiency of radon and thoron

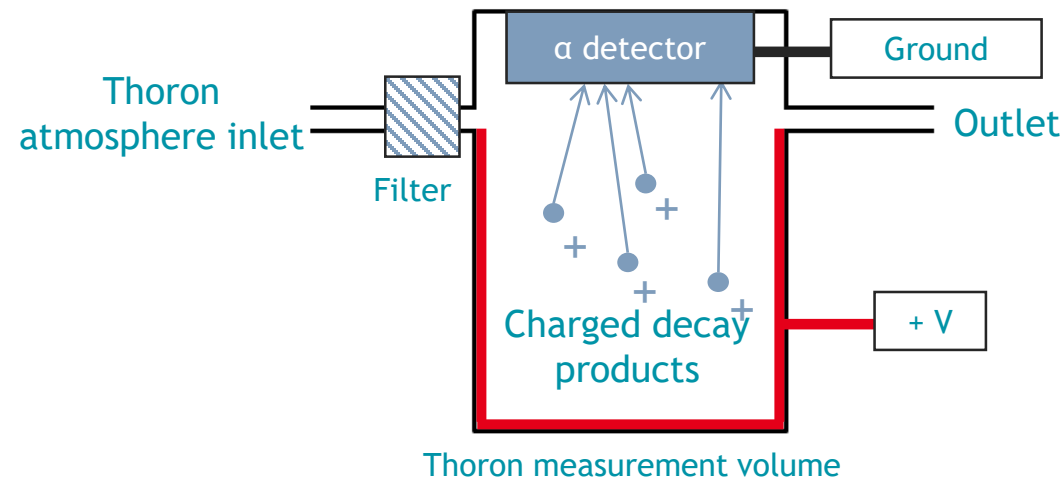

- Electric field strong enough to capture charged progeny produced in the volume:
  - Ion drift velocity much higher than fluid velocity
  - Minimise the residence time of the progeny in the volume to avoid neutralisation

# Development of the measuring device

- Monte Carlo (MCNPX): detection efficiency calculation and transport of alpha particles in matter
- Comsol Multiphysics: fluid transport, electric field and charged particle transport

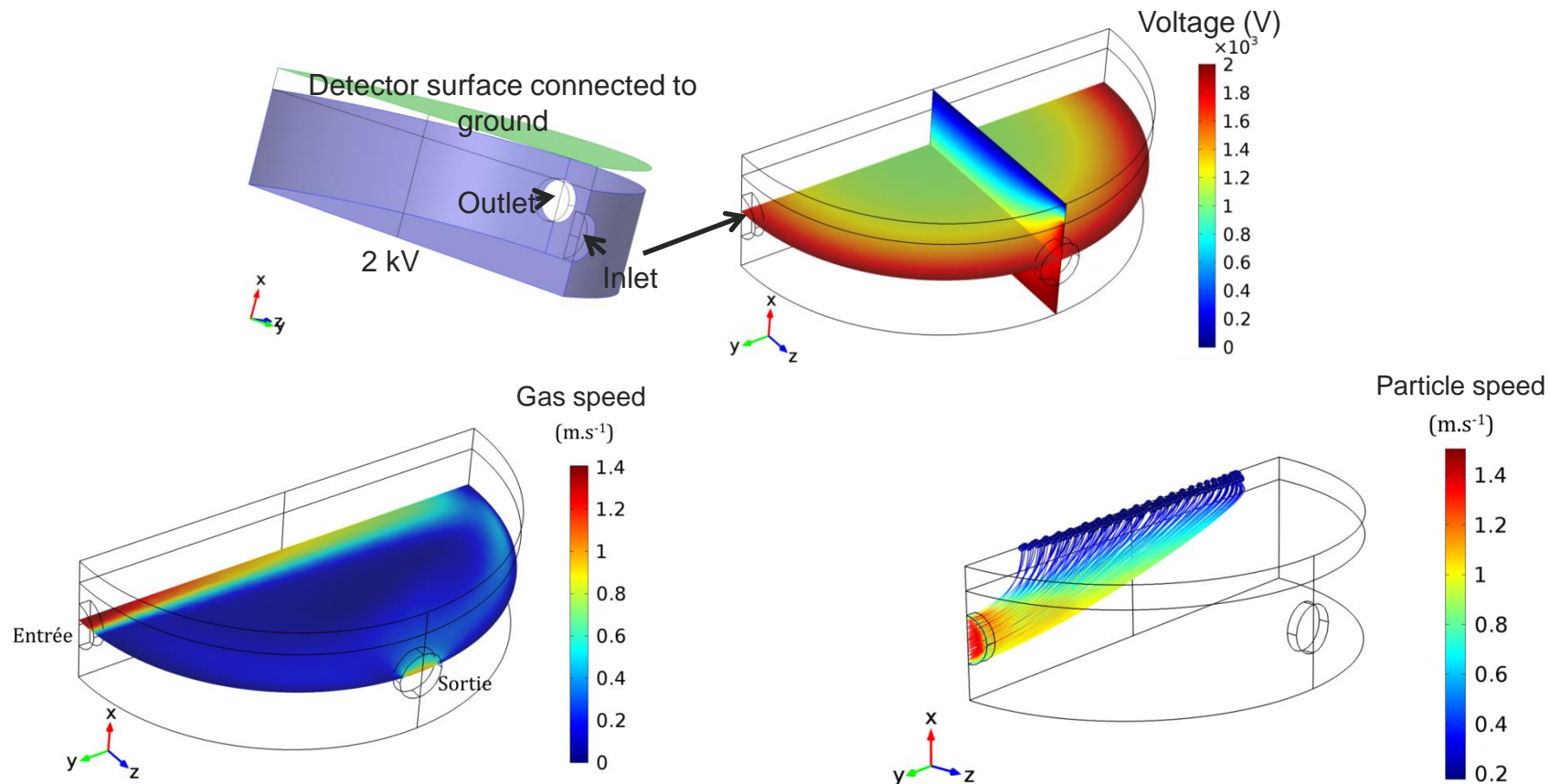

# Measurement device

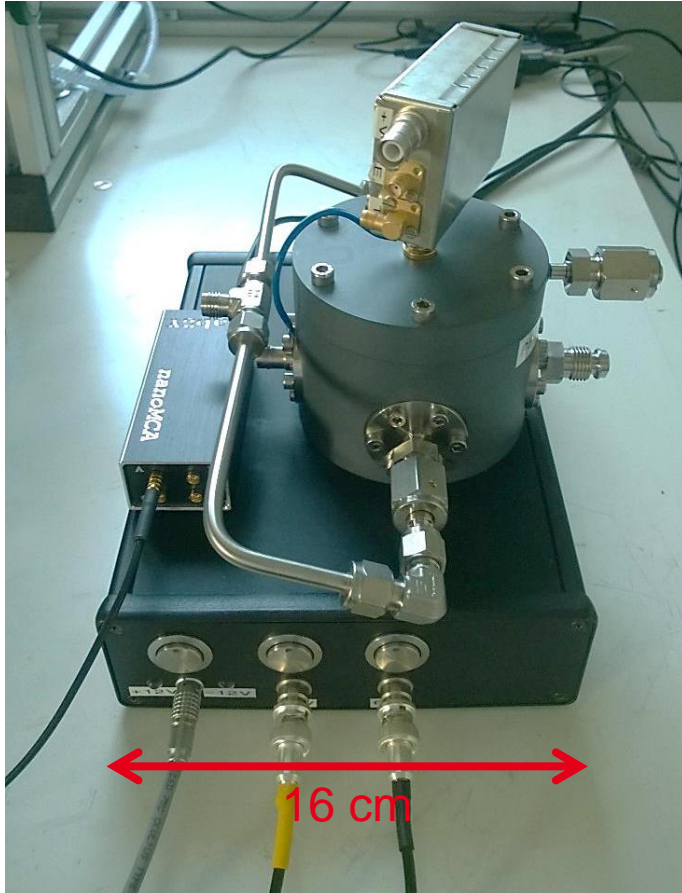

- Backpackable device (tested while flying to Rome)
- Pre-amplifier adapted to the specificities of the silicon detector to optimise the resolution
- Filtered power supplies to minimise electronic noise
- LabZY nanoMCA: a compact, high performance multi-channel analyser with open source code allowing its integration into acquisition software developed under LabVIEW
- Corresponding publications:
  - B. Sabot, et al., Radiation Protection Dosimetry (2015), doi:10.1093/rpd/ncv221
  - B, Sabot, thesis: Etalonnage des instruments de mesure de l'activité volumique du thoron ( $^{220}\text{Rn}$ ) dans l'air <https://www.theses.fr/2015SACLS122.pdf>
  - B. Sabot, et al., Applied Radiation and Isotopes (2015), <http://dx.doi.org/10.1016/j.apradiso.2015.11.055>

# Validation of the system with radon primary standard

- Estimation of the peak area of  $^{218}\text{Po}$  and  $^{214}\text{Po}$  to remove their contributions to the  $^{222}\text{Rn}$  peak (Colegram software)

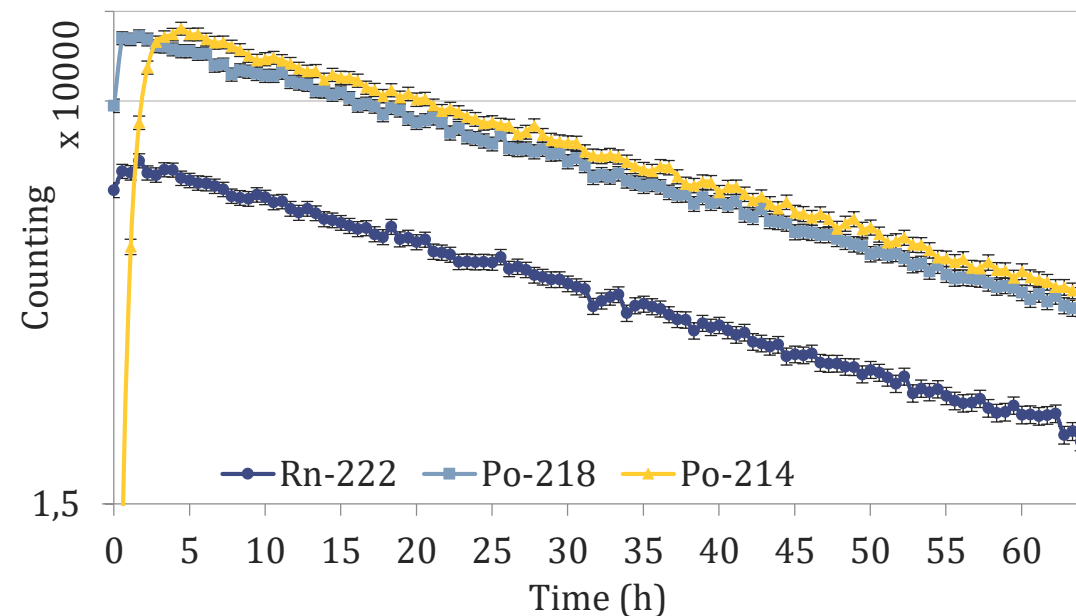
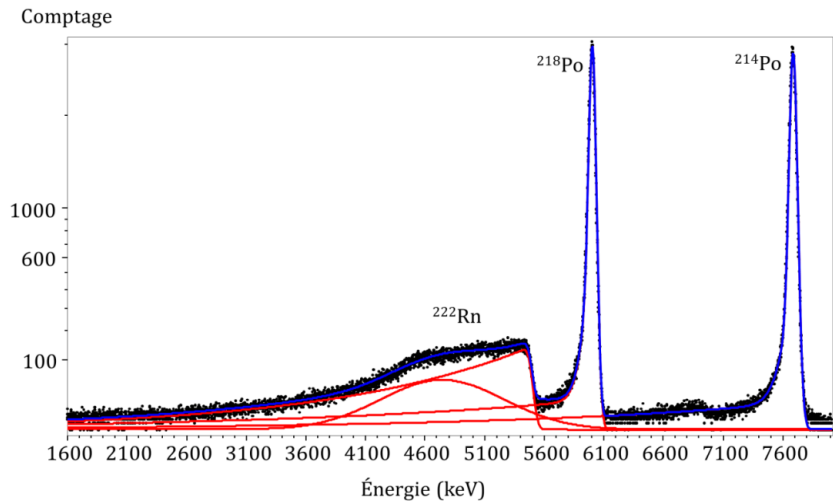

Trailing characteristics of the  $^{218}\text{Po}$  peak obtained with the  $^{214}\text{Po}$  peak

- The detection efficiency of the  $^{222}\text{Rn}$  peak obtained experimentally is 32.0 (2) %, the efficiency obtained by MCNPX calculation is 31.86 (3) %
- Experimental results consistent with simulations: this yield will be the same for the  $^{220}\text{Rn}$  peak



# Application of the system to the measurement of thoron

- Similar characteristics to  $^{222}\text{Rn}$  spectrum
  - All radionuclides are identifiable
  - The  $^{220}\text{Rn}$  alpha peak is disturbed by the presence of  $^{212}\text{Bi}$

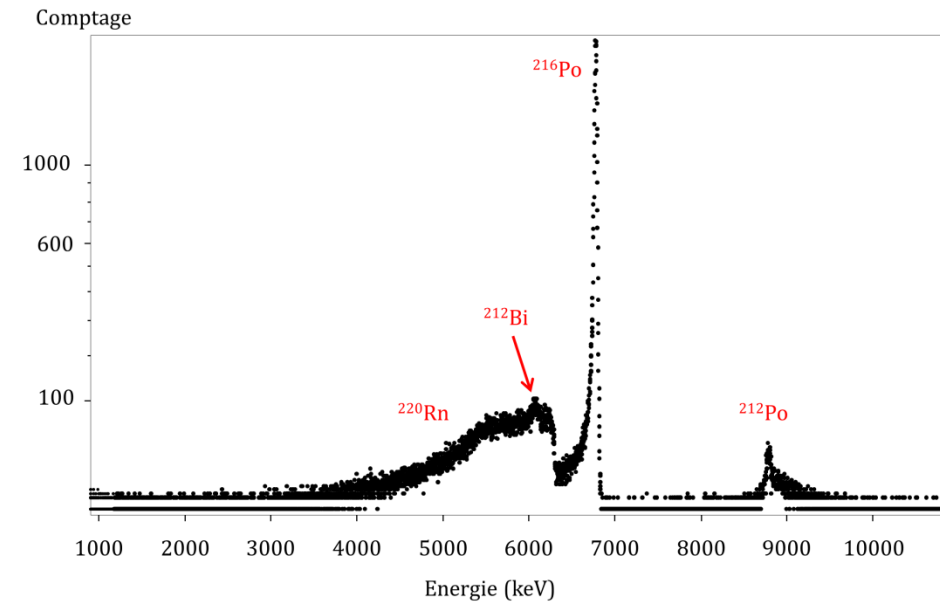
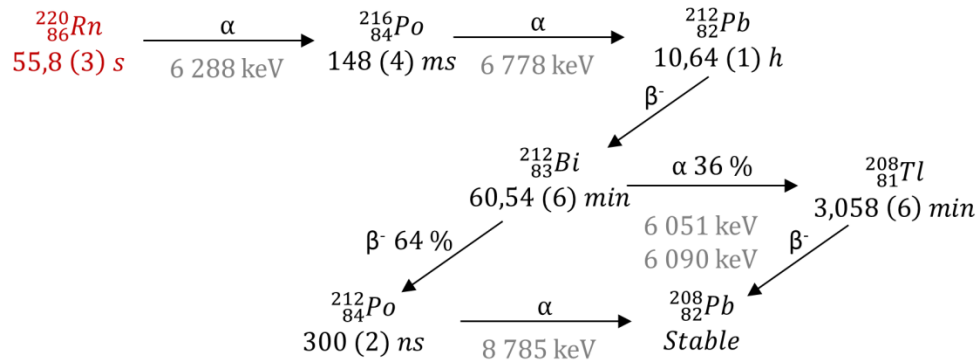

- $^{212}\text{Po}$  and  $^{212}\text{Bi}$  are instantly in secular equilibrium:
  - Using the  $^{212}\text{Po}$  peak to deduce the  $^{212}\text{Bi}$  supply in the  $^{220}\text{Rn}$  region of interest
  - It must be verified that the equilibrium is respected in the measurement system

# Experimental verification of branching ratio

- After a long exposure to a thoron atmosphere, the measurement volume is flushed with clean dry air
  - A spectrum is obtained
- The experimental results based on the count ratio of the two peaks give:

$$\frac{\alpha(^{212}\text{Bi})}{\alpha(^{212}\text{Po})} = 0.561 (7)$$

- Result that can be compared to nuclear data:

$$\frac{\alpha(^{212}\text{Bi})}{\alpha(^{212}\text{Po})} = \frac{\alpha(^{212}\text{Bi})}{\beta(^{212}\text{Bi})} = \frac{35.91}{64.09} = 0.560 (3)$$

- The results are in good agreement, it is possible to use the  $^{212}\text{Po}$  peak and the branching ratio to deduce the count related to the  $^{212}\text{Bi}$  peak

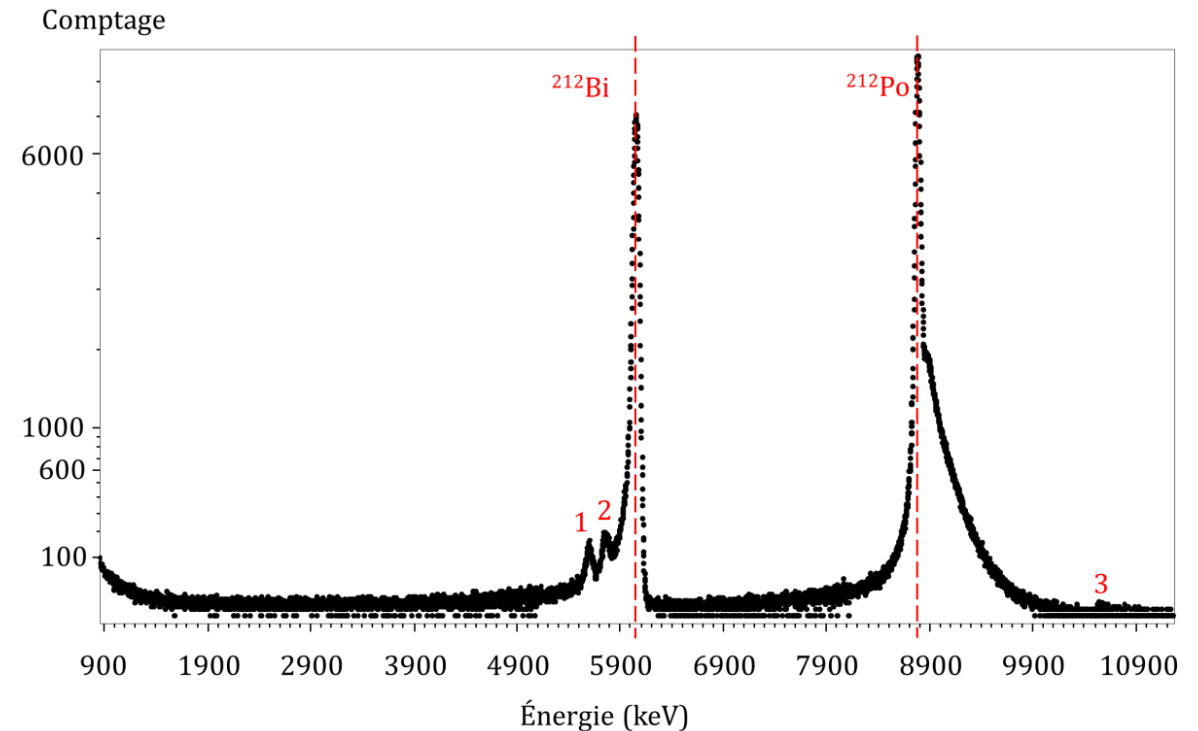

# Studies of the Parameters influencing the measurement

- As for radon, relative humidity, pressure and temperature have no impact on the measurement as it is designed so and it was verified between 3% RH to 94% RH, 18°C and 24°C and for a pressure between 900 hPa and 1 050 hPa
- In contrast to radon, due to the very short half-life of thoron, the flow rate can have an influence on the measurement: in the measurement system the flow rate must be higher than 0.8 L·min<sup>-1</sup>

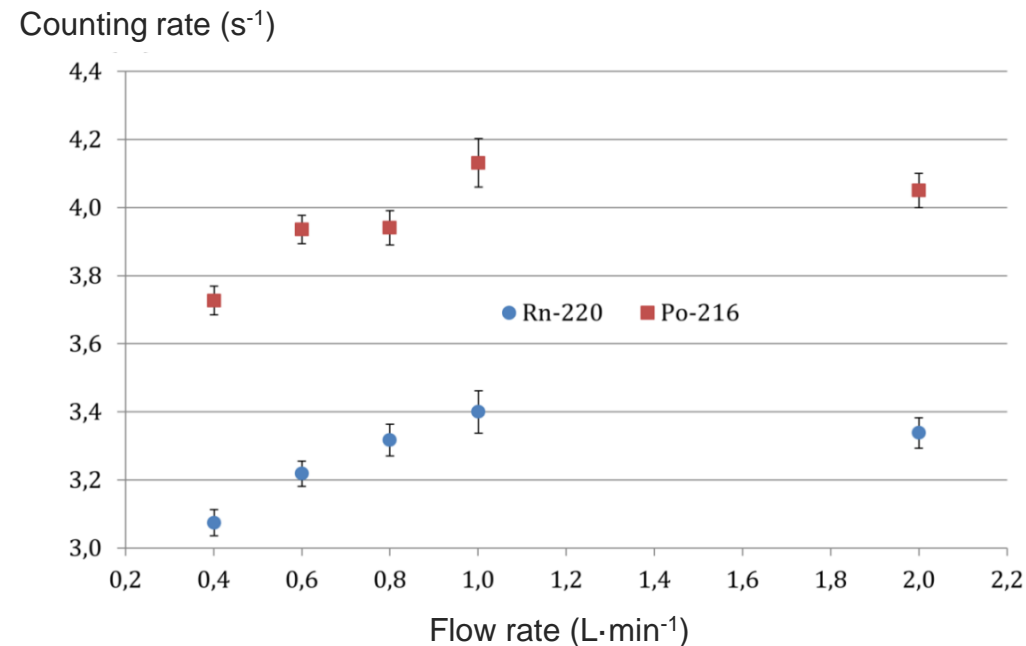

# Activity concentration calculation

- The developed system can be used to measure activity concentration of thoron for a stable atmosphere either with  $^{220}\text{Rn}$  peak or  $^{216}\text{Po}$  peak

$$A_{V\ 220\text{Rn}} = \frac{N_{220\text{Rn} + 212\text{Bi}} - N_{212\text{Po}} \frac{\alpha(^{212}\text{Bi})}{\beta(^{212}\text{Bi})}}{t_m V_{\text{det}} R_d 220\text{Rn} e^{\left(-\lambda_{220\text{Rn}} \frac{V_t}{Q}\right)}}$$

	Value	Relative standard uncertainty (%)	Contribution (%)
$N_{220\text{Rn} + 212\text{Bi}}$	68 783 (271)	0.4	27.6
$N_{212\text{Po}}$	42 289 (206)	0.5	5.1
$\frac{\alpha(^{212}\text{Bi})}{\beta(^{212}\text{Bi})}$	0,560 (6)	0.1	24.5
$t_m$	3 003 (1) s	0.03	0.1
$V_{\text{det}}$	12.444 (40) · 10 <sup>-6</sup> m <sup>3</sup>	0.3	8.0
$R_d 220\text{Rn}$	0,320 (2)	0.6	30.4
$\lambda_{220\text{Rn}}$	12.42 (7) · 10 <sup>-3</sup> s <sup>-1</sup>	0.5	0.0
$V_t$	2,5 (3) · 10 <sup>-5</sup> m <sup>3</sup>	12	3.9
$Q$	1.667 (2) · 10 <sup>-5</sup> m <sup>3</sup> ·s <sup>-1</sup>	0.1	0.0
$A_{V\ 220\text{Rn}}$	3,843 (43) MBq·m <sup>-3</sup>	1	

$$A_{V\ 220\text{Rn}} = \frac{N_{216\text{Po}}}{t_m V_{\text{det}} R_d 216\text{Po} e^{\left(-\lambda_{220\text{Rn}} \frac{V_t}{Q}\right)}}$$

	Value	Relative standard uncertainty (%)	Contribution (%)
$N_{216\text{Po}}$	65 978 (257)	0.4	3.0
$t_m$	3 003 (1) s	0.03	0.0
$V_{\text{det}}$	12,444 (40) · 10 <sup>-6</sup> m <sup>3</sup>	0.3	2.1
$R_d 216\text{Po}$	0,465 (10)	2.1	93.7
$\lambda_{220\text{Rn}}$	12,42 (7) · 10 <sup>-3</sup> s <sup>-1</sup>	0.5	0.0
$V_t$	2,5 (3) · 10 <sup>-5</sup> m <sup>3</sup>	12	1.0
$Q$	1,667 (2) · 10 <sup>-5</sup> m <sup>3</sup> ·s <sup>-1</sup>	0.1	0.0
$A_{V\ 220\text{Rn}}$	3,865 (86) MBq·m <sup>-3</sup>	2.2	

# Use of the system for calibration

- Thoron presents a major problem: its very short half-life makes it difficult to produce a homogeneous atmosphere.
- Several solutions are possible:
  - Simulate the inhomogeneity using an accurate model (fan position optimisation)
  - Measure the inhomogeneity using an adapted technique (technique tested with silica aerogel)
    - K. Mitev et. al. Methods for the experimental study of  $^{220}\text{Rn}$  homogeneity in calibration chambers, (2020), Appl. Radiat. Isot. 165, [10.1016/j.apradiso.2020.109259](https://doi.org/10.1016/j.apradiso.2020.109259)
  - Make the reference measurement as close as possible to the sampling point of the device to be calibrated (preferred technique)

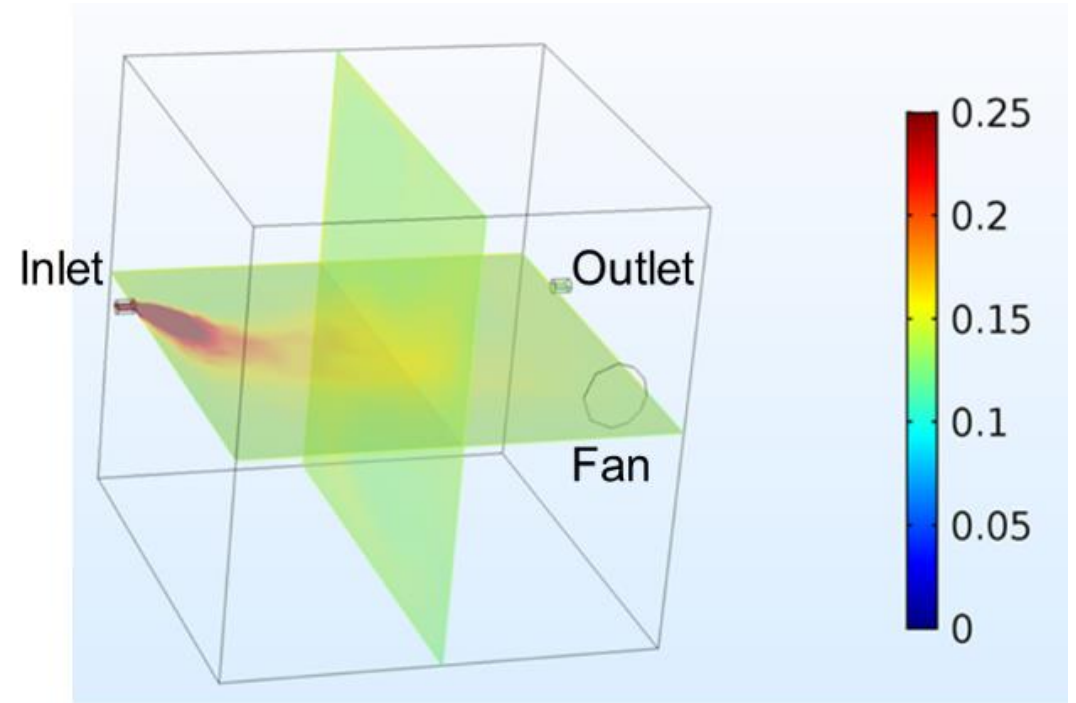
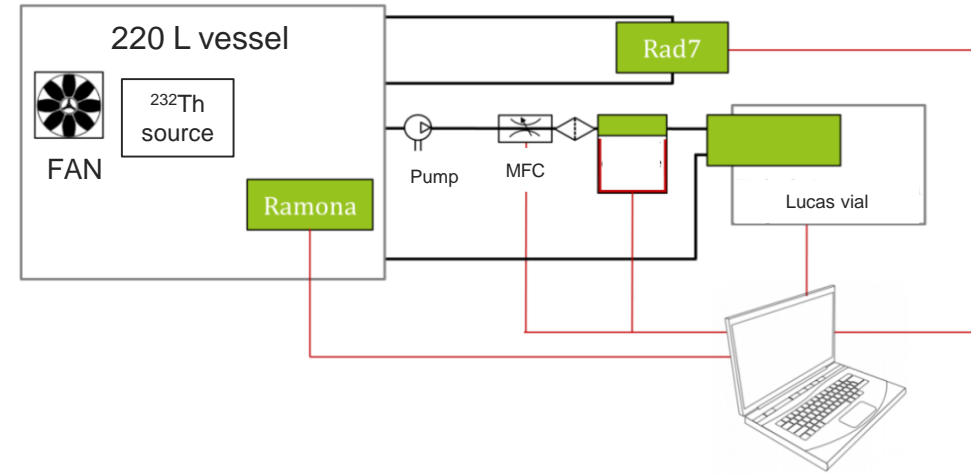

Image in the gas bench of the LNHB

# Validation and comparisons

- One comparison was performed at ENEA in Italy:
  - Thoron production using a  $^{232}\text{Th}$  source in a closed volume
  - Comparison of thoron measurement with the reference method under development at ENEA



Device	Mesure 1	Mesure 2
Thoron measurement device	22.2 (4) kBq·m <sup>-3</sup>	22.0 (3) kBq·m <sup>-3</sup>
Lucas - ENEA	22.1 (8) kBq·m <sup>-3</sup>	21.7 (8) kBq·m <sup>-3</sup>

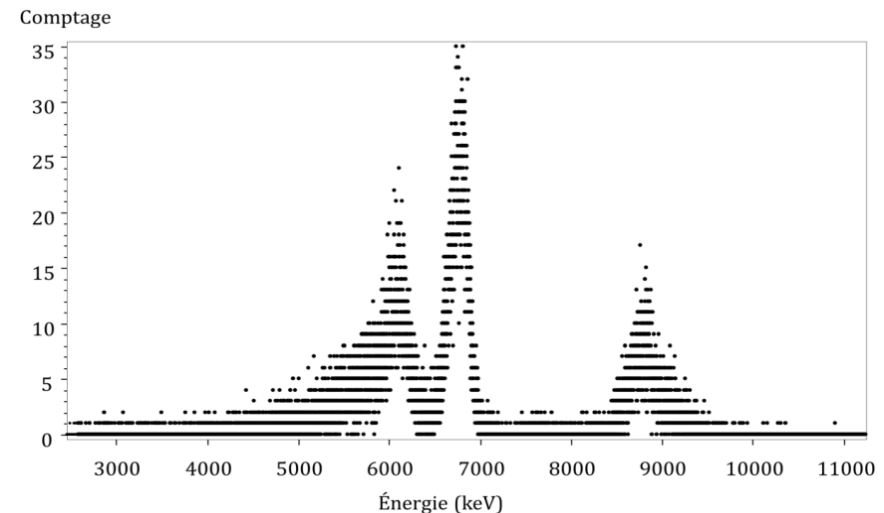



# 9 ■ Radon measurements and considerations

Studies of interest of different European projects

# General observations to take into account

- The calibration of radon detector is important but primary calibration is not always necessary, secondary calibration is far enough for on site measurement
- It is always mandatory to verify the response linearity of instruments (some saturate and give 0 while you have high concentration)
- The background may have a great influence especially due to the decay scheme of radon where some have a long half-life and contaminate detector:
  - The only way to keep a low background is to place your instrument in clean atmosphere when it is not used
  - Instruments with alpha spectrometry can be useful to reduce background influence
- Many instruments have been developed only for radon and do not take into account the presence of thoron, it is necessary at least to estimate this component and reduce it;
  - this was one of the objective of MetroRADON project, results are available on website:  
<http://metroradon.eu/>





# 10. Unusual example of the use of radon standards

# Radon on Mars ?

- This work was started by the thesis of Pierre Yves Meslin in 2008: “Radon, a geophysical tracer of the Martian environment: study of its transport, first evidence and development of instrumentation for its measurement”
- The idea was to use the data from silicon detector on RAD detector from Curiosity to measure radon on Mars and study radon transport on Mars
- Calibration of the RAD copy with radon in 7 mbar of CO<sub>2</sub> in 2016 in BACCARA at IRSN with radon primary standard from CEA/LNHB
  - This is the reason why radioactive gas chamber can work under low pressure at CEA/LNHB

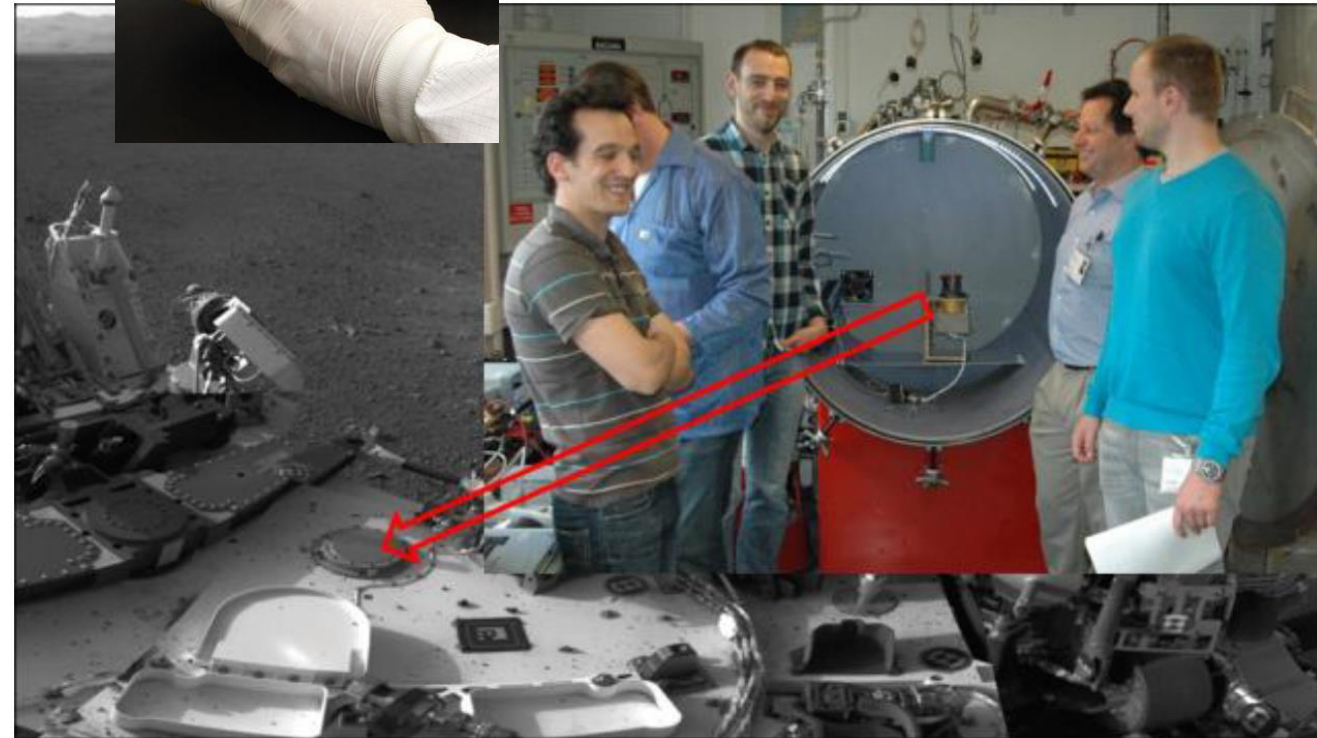

# Radon on the Moon ?

- In a very good vacuum and without atmosphere radon transport is challenging to study
- DORN instrument is planned to be launched with Cheng'E 6 mission from China that will bring moon samples (2024)
- There is a need to understand transport of radon in Moon regolith:
  - methods adaptation and development are undergoing to use primary standard for such studies
  - expected first results later this year !

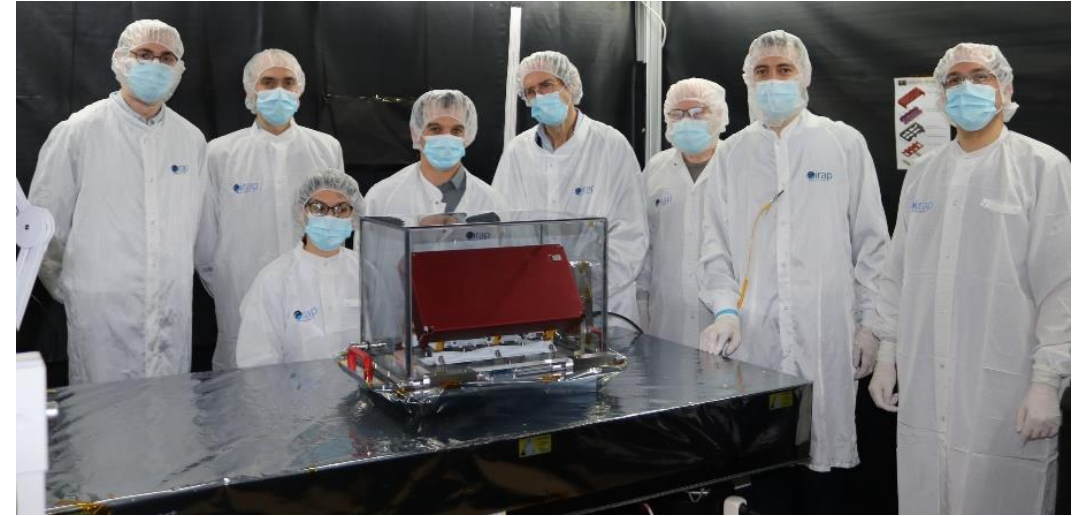

# Radon from a diamond ?

- Some people are using  $^{226}\text{Ra}$  to turn white diamond into green diamond and increase (a lot) their value
- Direct alpha spectrometry may not be possible on such piece or radium may have diffused inside the diamond
- The frozen DSA system can be used to trap the radon produced by the diamond and perform a precise and certified measurement to know if the diamond is modified or not

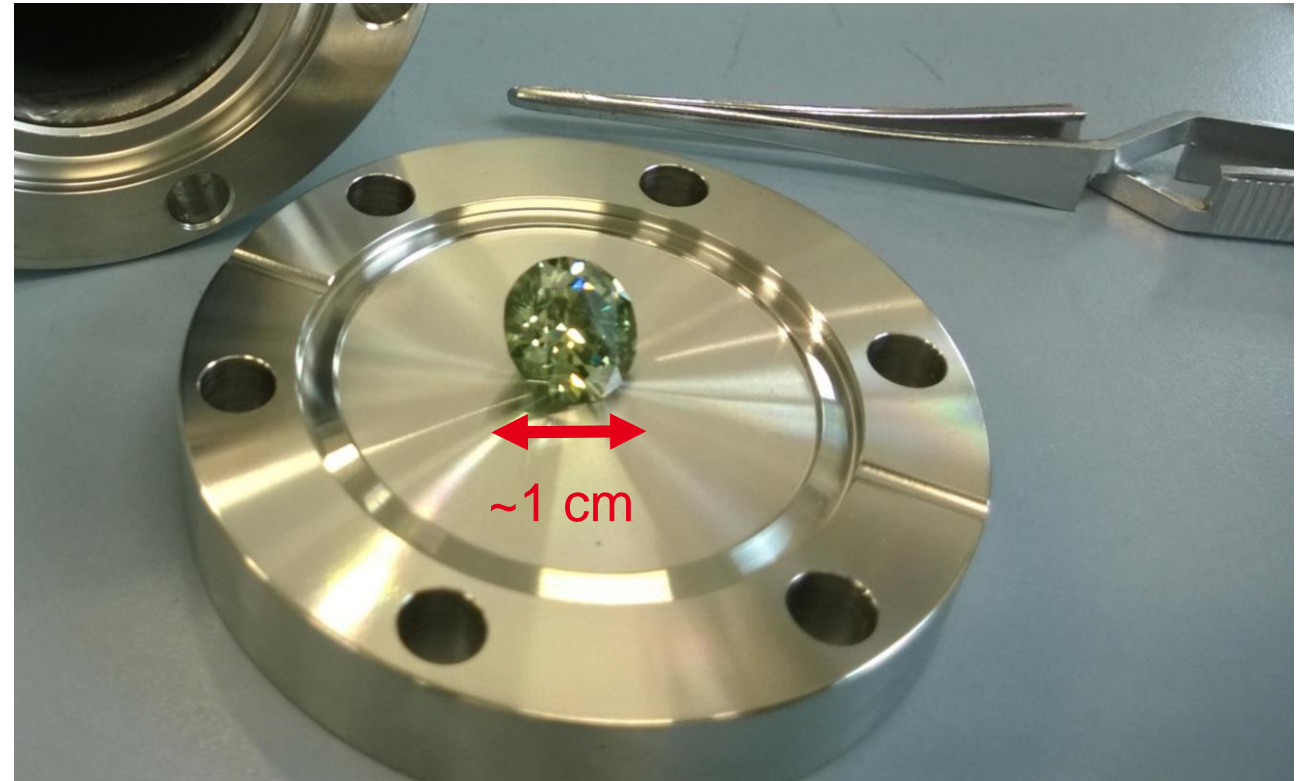



# 11 ■ Summary

# Summary

- Some standard for radon and thoron were presented
- Radon standards are used in many countries and some effort were done in order to implement international traceability
- They can be adapted to calibrate commercial devices
- Thoron is not so developed in the world without any official international traceability
- Thoron and radon can have a mixed contribution for some device measurement it is important to consider this aspect during measurement and know how device respond
- Linearity is one of the key aspect of device measurements as it can be important to simplify calibration also
- Some complementary development are necessary and undergoing for radon metrology at CEA/LNHB;
  - time response measurement of commercial device (technique already investigated and can be applied using the thoron measurement device)
  - radon-in-water standard (we found the technique it should be published this year)
  - Adsorption and desorption of radon from various materials (undergoing with DORN project)
- Long term work should bring standard for radon decay products which are in fact the real problem in term of dose !

# Credits

Much of the work presented here has been partly funded by the French National Metrology Laboratory, LNE. The developments were also performed in the framework of European projects with other national metrology institut such as MetroNORM, MetroRADON and they continue in the framework of other projects such as SPARTE (FET-OPEN: Porous scintillator for radioactive gas) and probably future European cooperation which are often fruitful in terms of development of new standards.



This is a presentation of some of the work on radon metrology and standard development but cannot reflect the whole work on radon isotope standard design around the world.

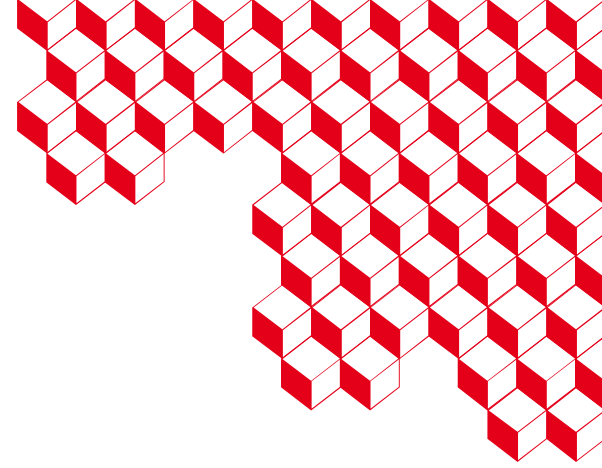

**Thank you**

[benoit.sabot@cea.fr](mailto:benoit.sabot@cea.fr)

Laboratoire National Henri Becquerel

CEA, Centre de Saclay