



HAL
open science

Combined XRR-GIXRF analysis at LNHB: technical and analytical developments

Yves Ménesguen, Stéphanie Melhem, E. Nolot, P. Jonnard, Marie-Christine Lépy

► **To cite this version:**

Yves Ménesguen, Stéphanie Melhem, E. Nolot, P. Jonnard, Marie-Christine Lépy. Combined XRR-GIXRF analysis at LNHB: technical and analytical developments. EXRS 2022 - European Conference on X-ray Spectrometry 2022, Jun 2022, bruges, Belgium. , 2022. cea-04142632

HAL Id: cea-04142632

<https://cea.hal.science/cea-04142632>

Submitted on 27 Jun 2023

HAL is a multi-disciplinary open access archive for the deposit and dissemination of scientific research documents, whether they are published or not. The documents may come from teaching and research institutions in France or abroad, or from public or private research centers.

L'archive ouverte pluridisciplinaire **HAL**, est destinée au dépôt et à la diffusion de documents scientifiques de niveau recherche, publiés ou non, émanant des établissements d'enseignement et de recherche français ou étrangers, des laboratoires publics ou privés.

- The **XRR** ("X-Ray Reflectivity") and **GIXRF** ("Grazing Incidence X-Ray Fluorescence") techniques make it possible to characterize the properties at the interfaces and in depth of materials deposited in very thin layers (thickness, roughness, composition, densities), CASTOR is a goniometer dedicated to these techniques.
- At LNE-LNHB we are developing the combined XRR-GIXRF analysis in a **reference-free** mode using calibrated instrumentation (SDD, photodiodes) and a user-friendly software dedicated to the complete analysis.

CASTOR goniometer

The **METROLOGIE** beamline (bending magnet) at SOLEIL has 2 branches equipped with monochromators:

- from 45 eV to 1,9 keV → "XUV", 3 VLS gratings
- from 3 keV to 35 keV → "XDURS", 2 Si(111) crystals
- Several filters and adjustable slits

CASTOR ("Chambre d'Analyse Spectrométrique en Transmission Ou en Réflexion") :

- HV chamber (10⁻⁶ hPa)
- 7 axes manipulator (2 rotations and 3 translations for the sample & 1 rotation and 1 translation for the photodiode)
- 3 axes frame
- Up to 4 photodiodes
- Spectrometer (SDD) on a translation stage
- Heating sample holder (up to 300 °C)
- dedicated LabVIEW® acquisition program (variable scanning steps, results in ASCII format)

→ Ménesguen, Y. *et al.*, X-Ray Spectrometry, 46, 303-308 (2017)

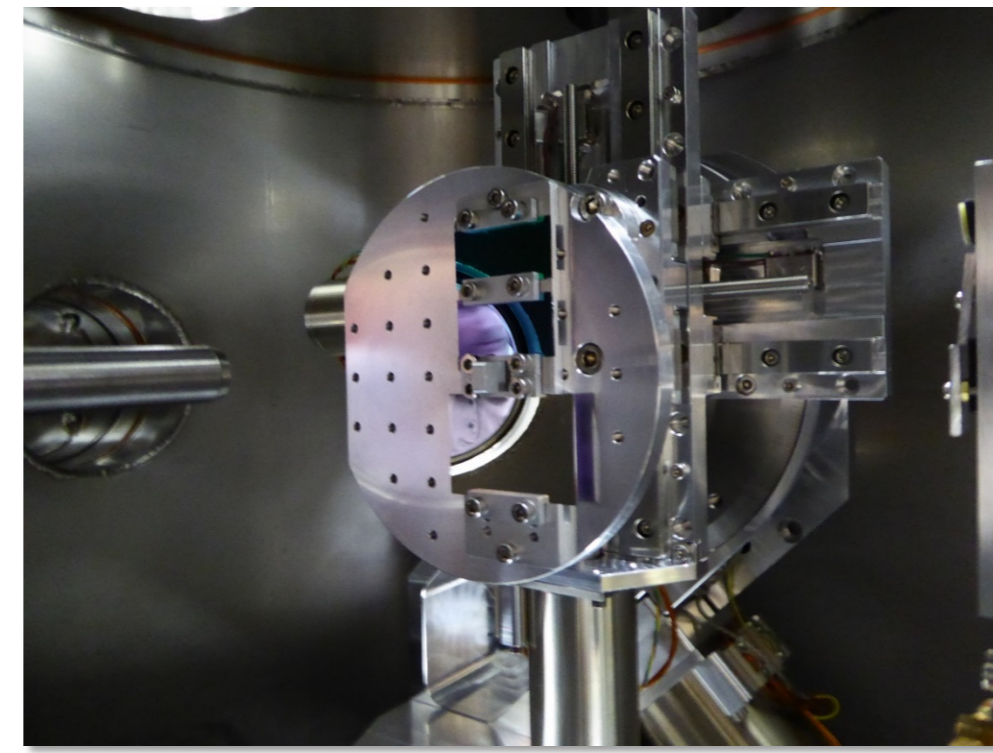

Sample holder

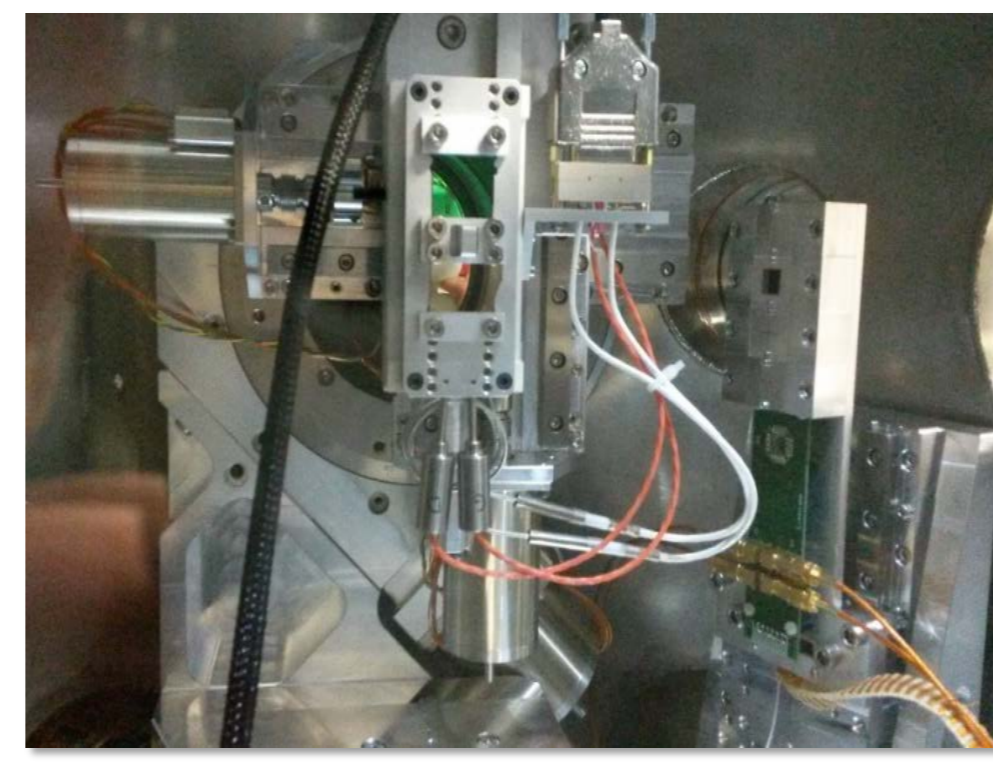

Heating sample holder

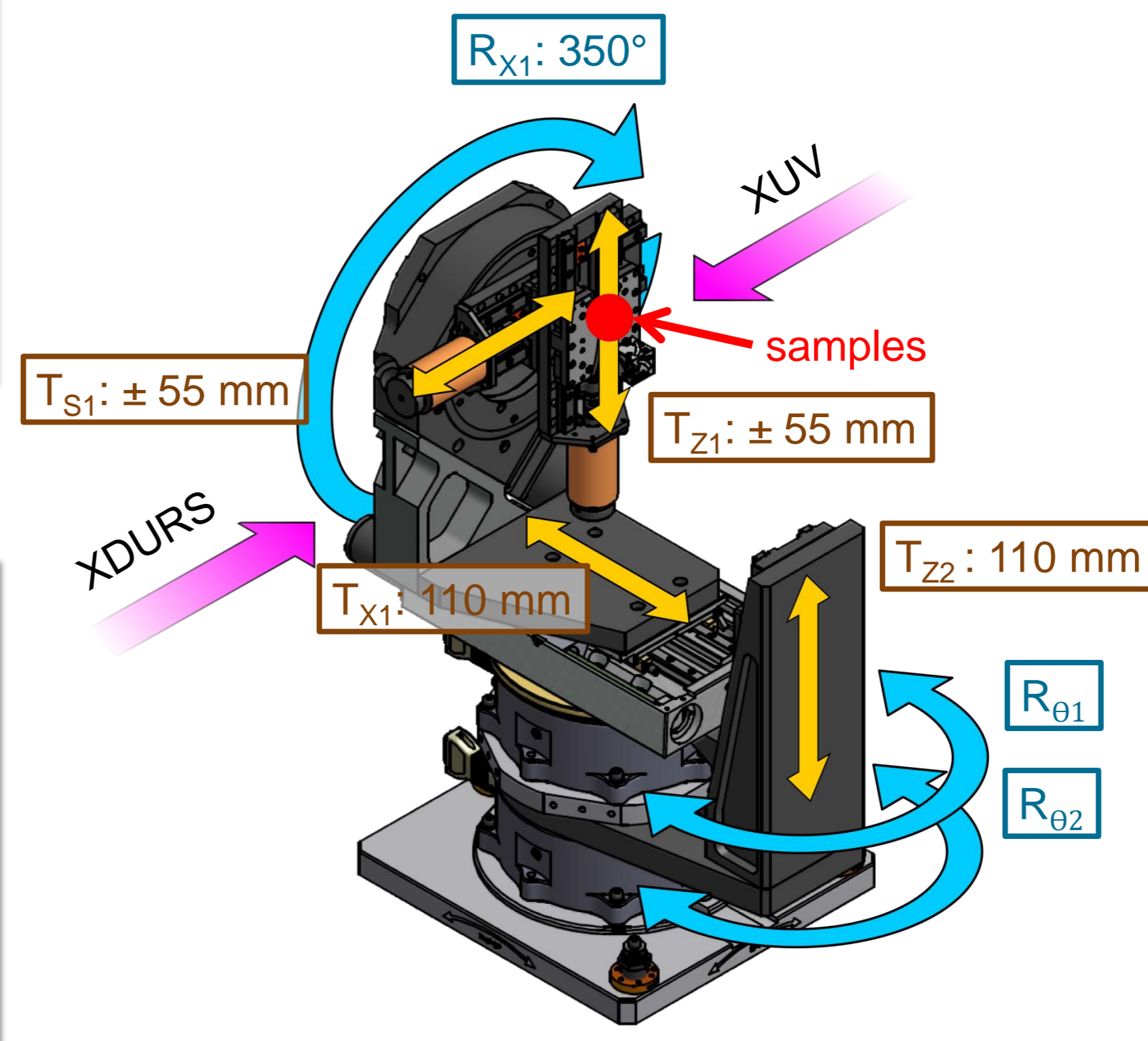

7 axes manipulator



CASTOR on XDURS

Reference-free combined XRR-GIXRF analysis with EliXir

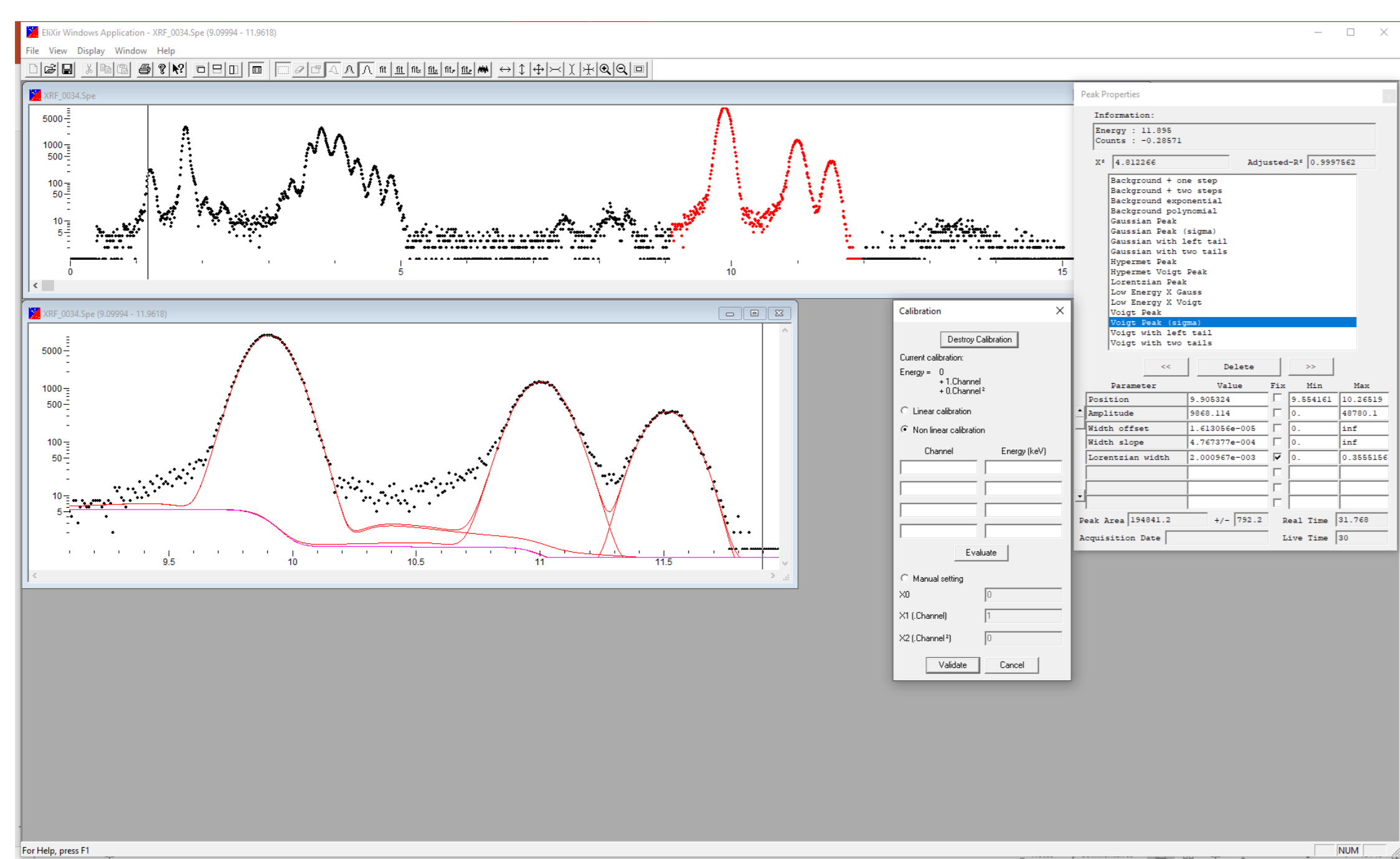

- Same XRF spectra analysis as **COLEGRAM** (Ménesguen, Y. *et al.*, Nuclear Instruments & Methods In Physics Research A, 1003, 165341 (2021))
- Atomic fundamental parameters (μ , τ , ω) (Ménesguen, Y. *et al.*, Metrologia, 53, 7-17 (2016))
- Beam geometry (Ménesguen, Y. *et al.*, Physica Status Solidi A, 2100423 (2021))

Software interface for multilayer model and optimization parameters. Includes sections for:

- Multilayer model
- Optimization parameters
- Solid angle calculation for the XRF and the XRR
- Layer definition: (thickness, roughness, density, composition)
- Excitation energy (XRR, XRF), acquisition time and flux (XRF)
- Optimization: XRR only, XRF only, both or none
- Parameters constraints
- Elements to compute the GIXRF

Examples of results

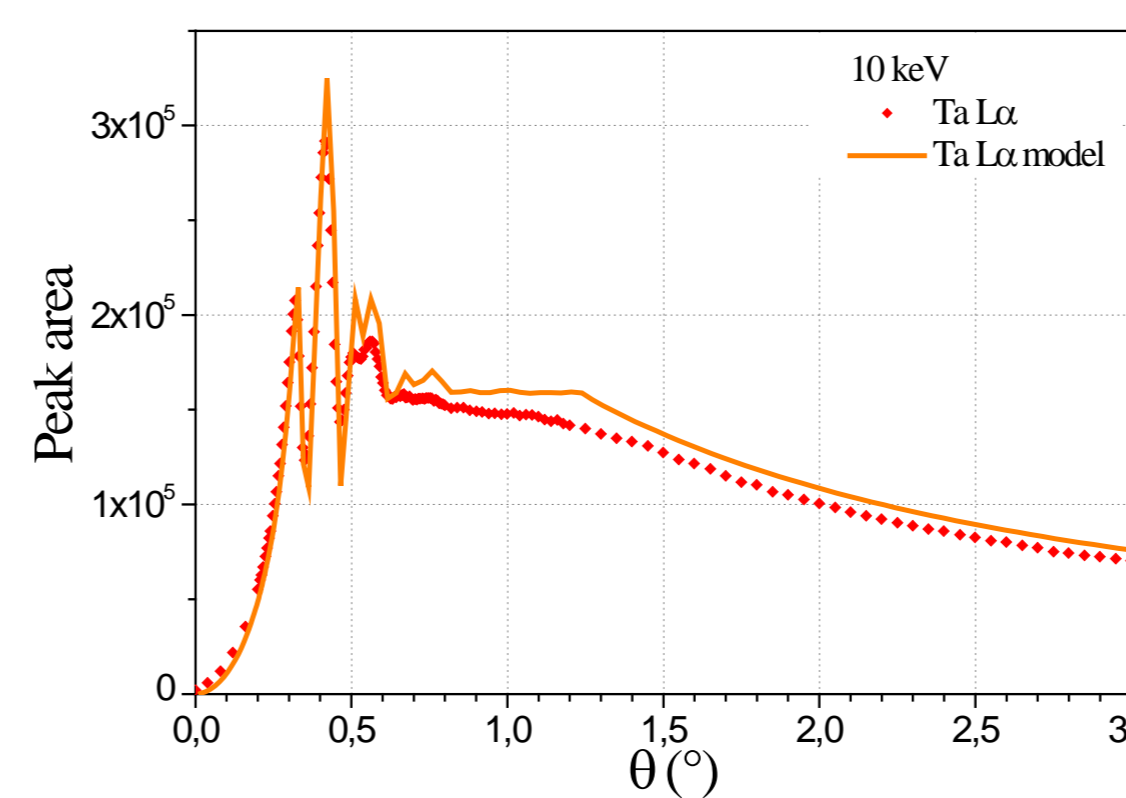
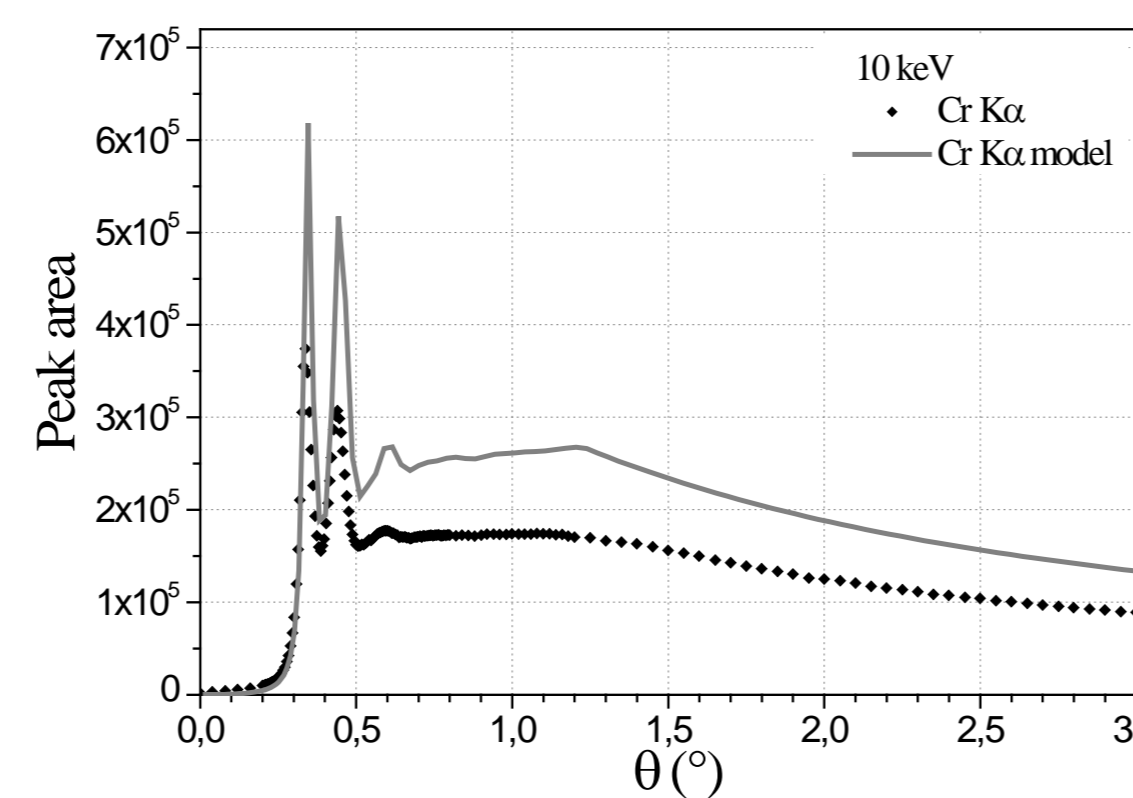
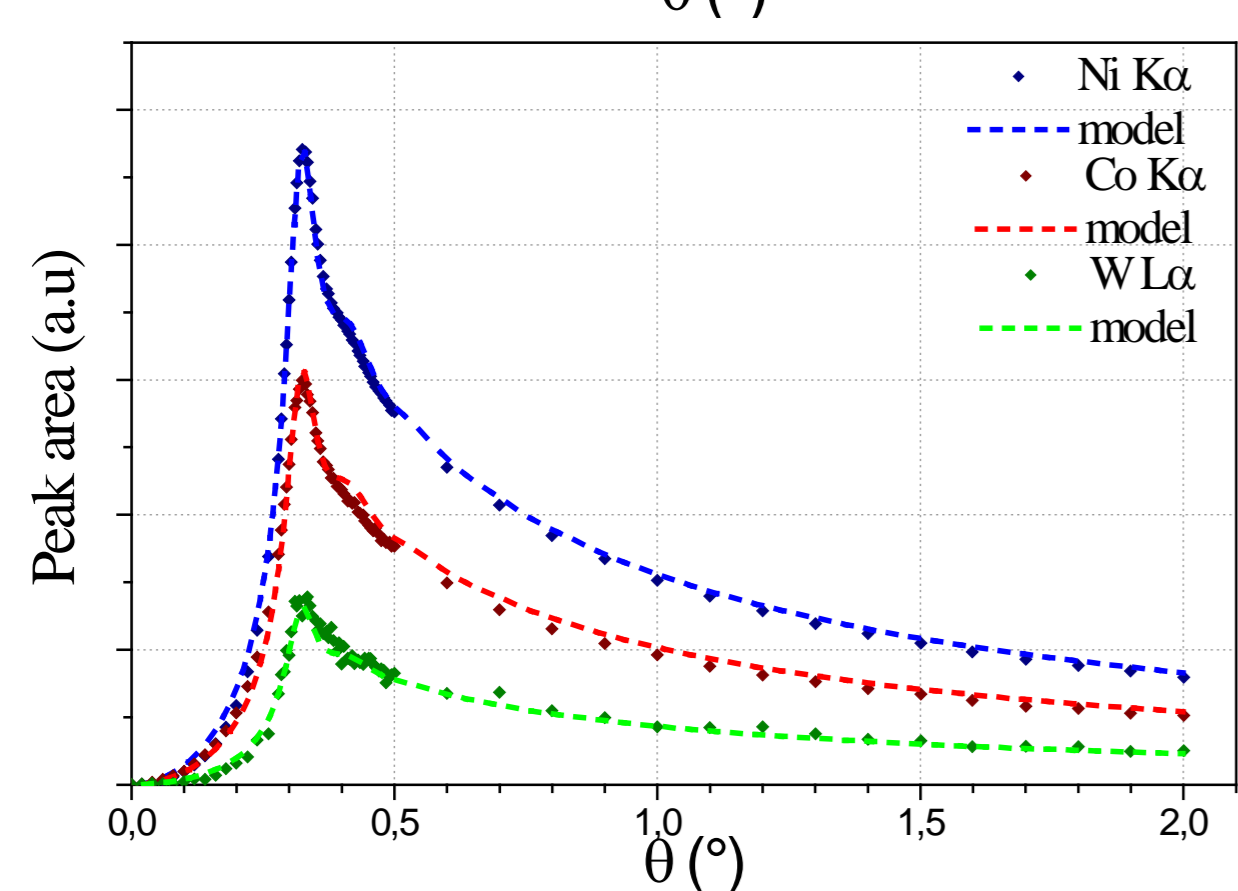
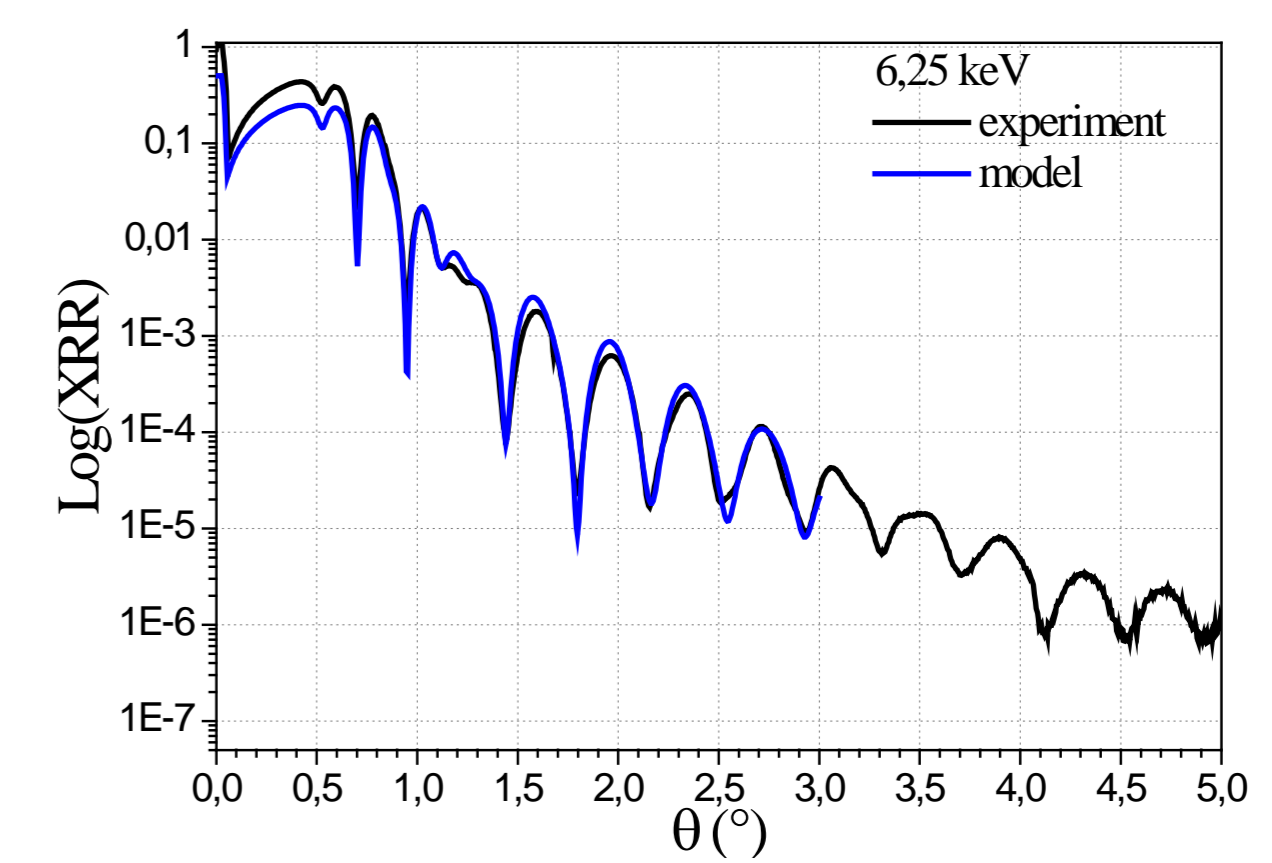
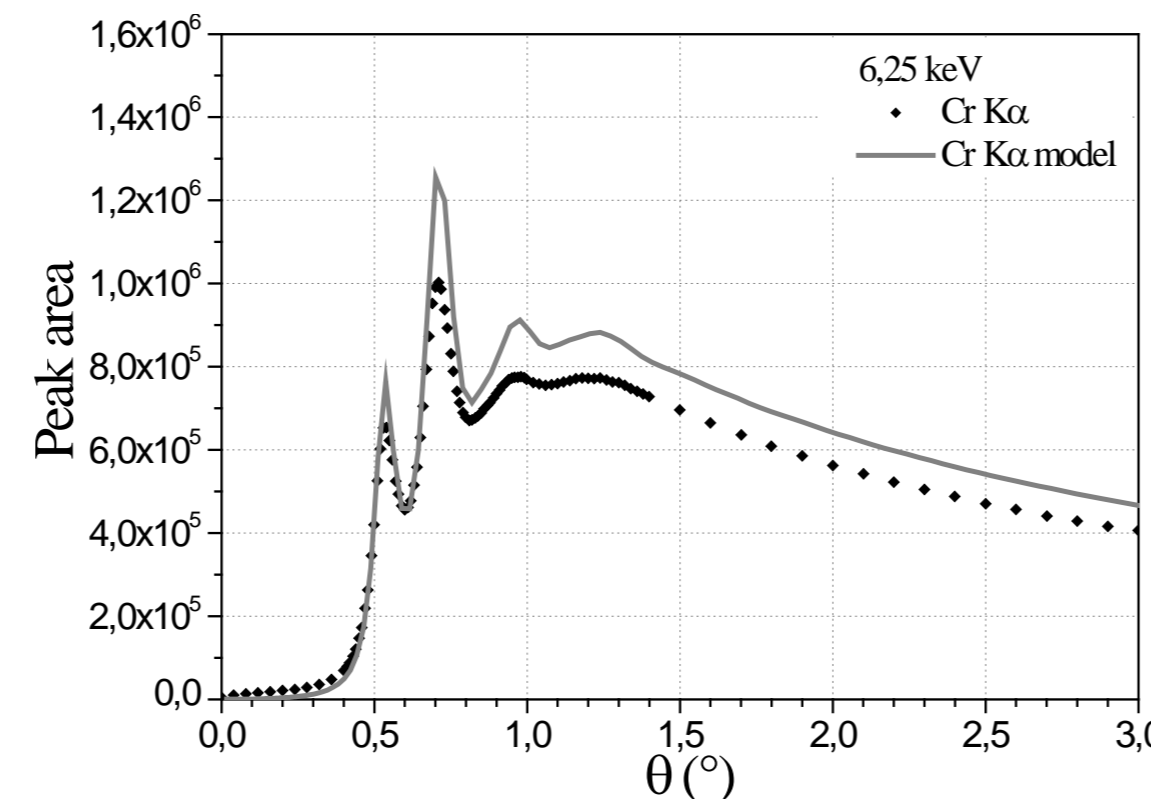
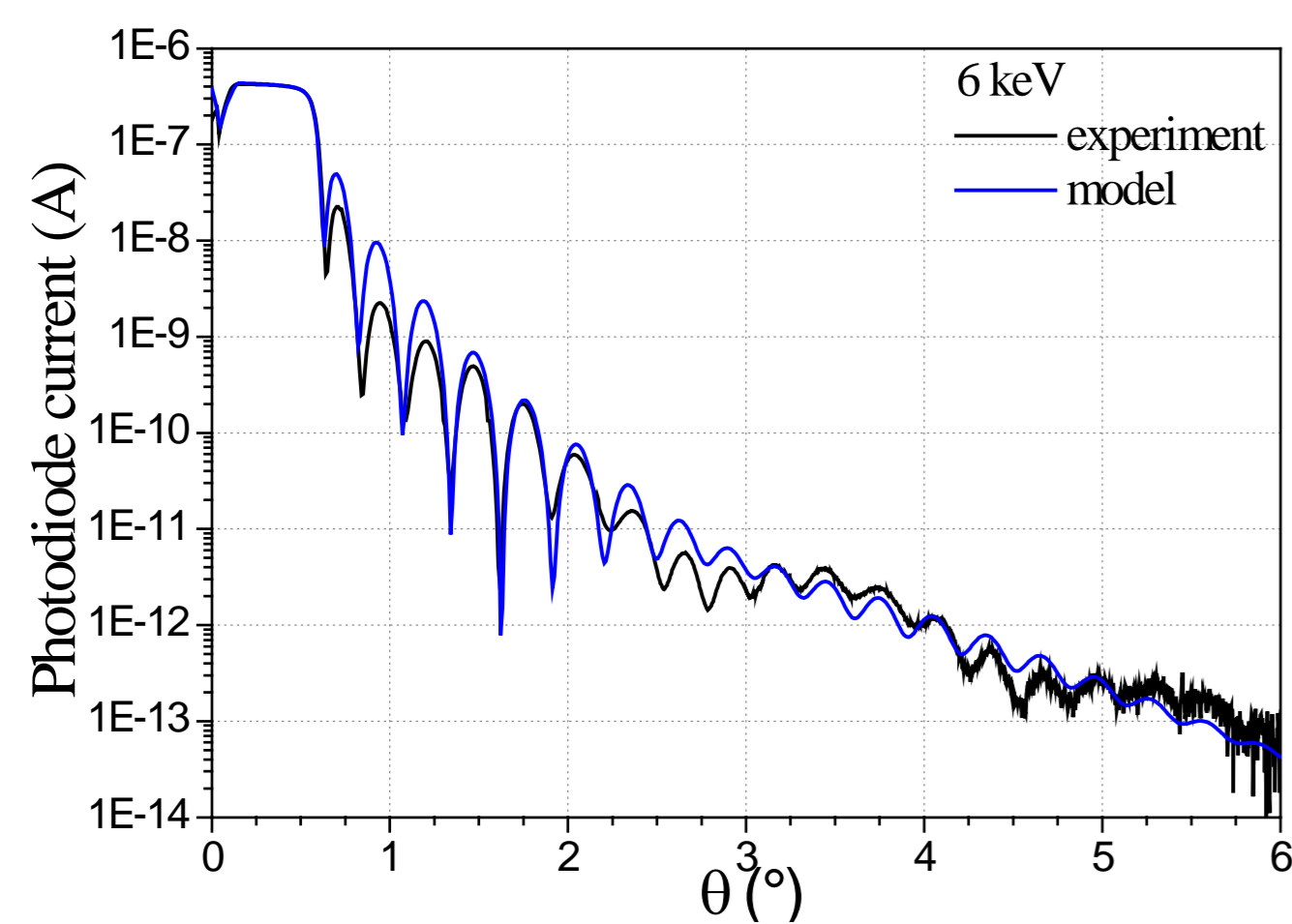

Ta ₂ O ₅	d = 1,88 nm	ρ = 6,16 g.cm ⁻³	σ = 1,11 nm
Ta	d = 3,97 nm	ρ = 16,14 g.cm ⁻³	σ = 1,12 nm
Cr	d = 13,65 nm	ρ = 7,00 g.cm ⁻³	σ = 0,94 nm
Pt	d = 13,9 nm	ρ = 21,5 g.cm ⁻³	σ = 0,53 nm
PtSi	d = 0,19 nm	ρ = 18,95 g.cm ⁻³	σ = 0,75 nm
Si Substrate			

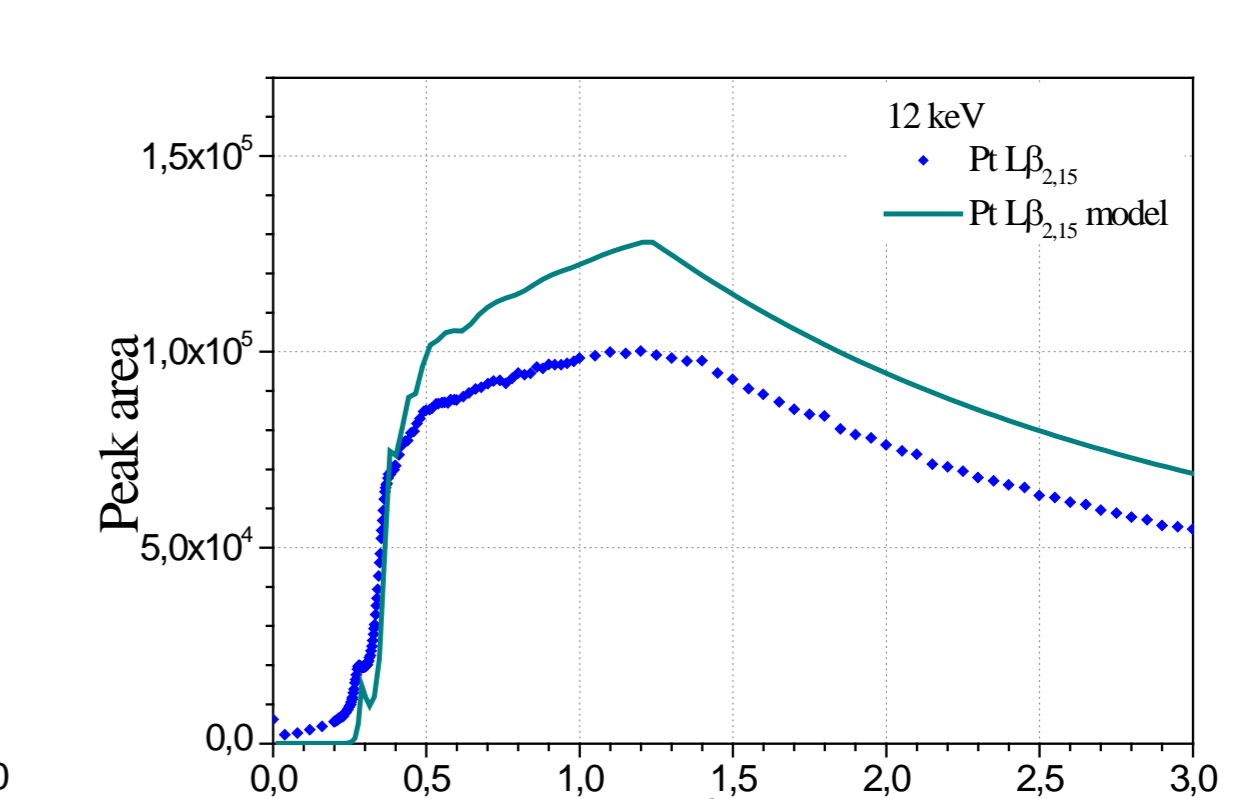
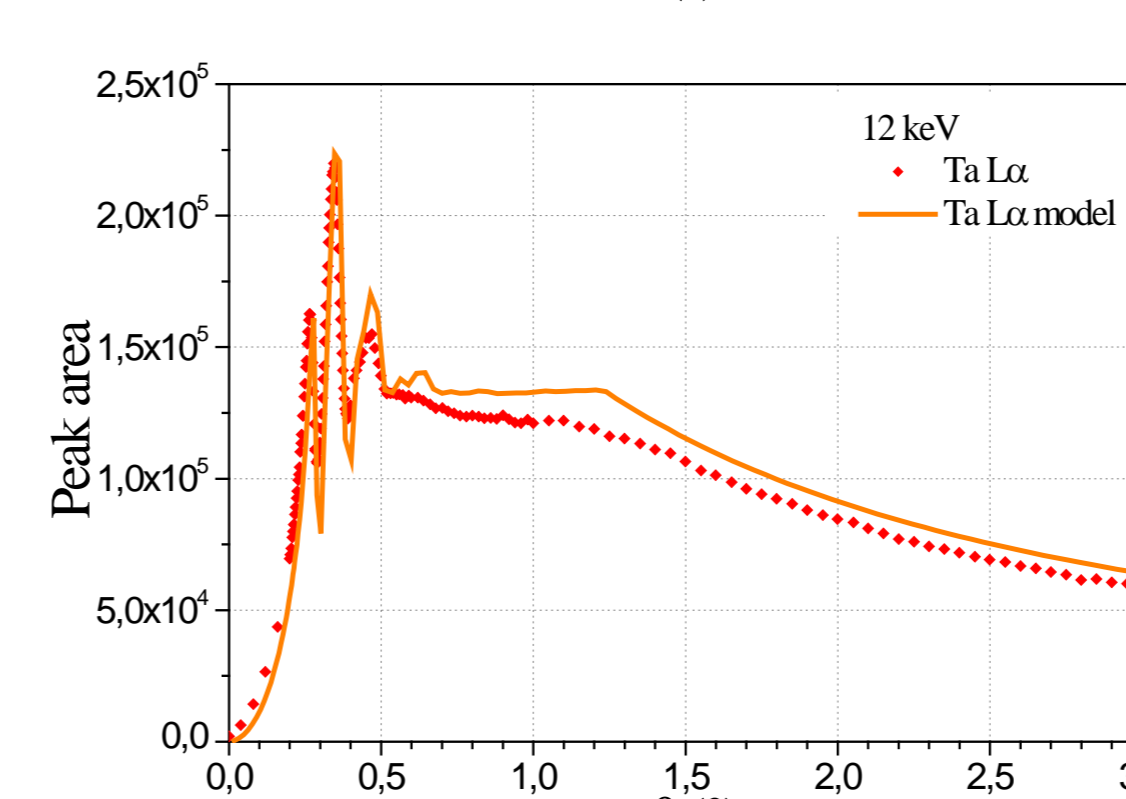
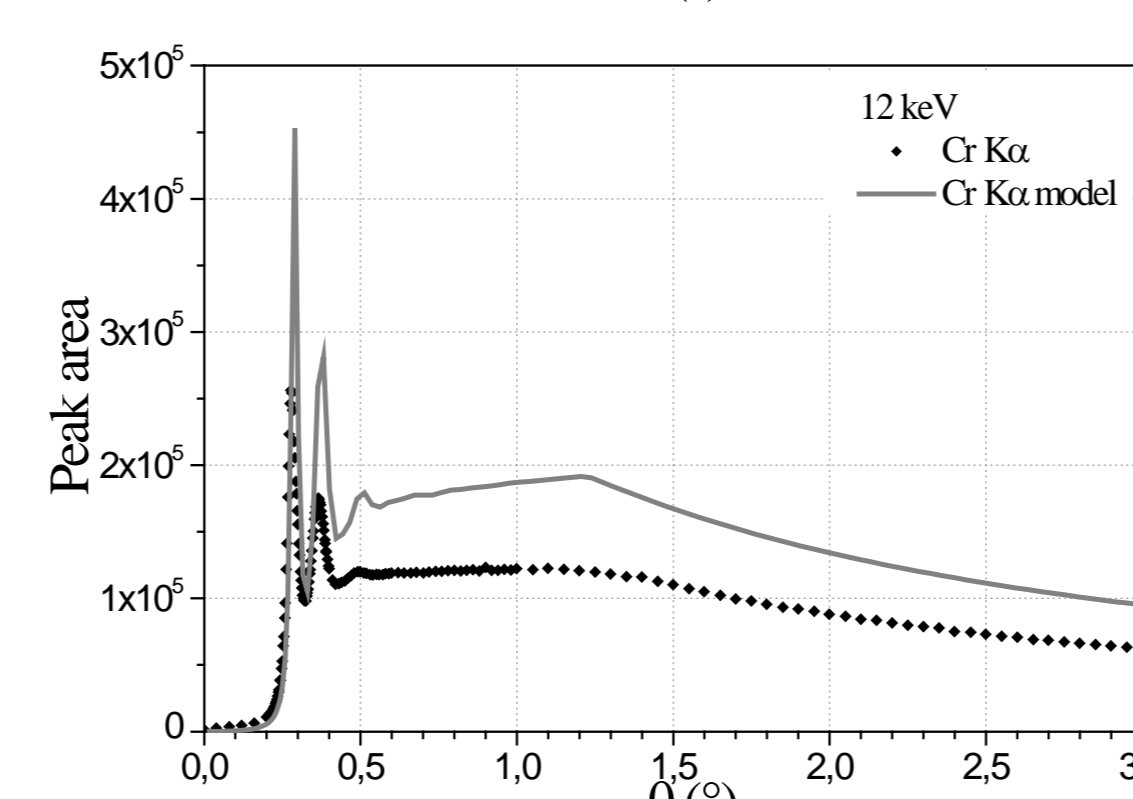

NiCo _{0,11} W _{0,01}	d = 1,02 nm	ρ = 5,76 g.cm ⁻³	σ = 0,53 nm
NiCo _{0,11} W _{0,01}	d = 17,52 nm	ρ = 8,74 g.cm ⁻³	σ = 0,47 nm
NiCo _{0,11} W _{0,01}	d = 1,15 nm	ρ = 8,12 g.cm ⁻³	σ = 0,47 nm
SiO ₂	d = 1,05 nm	ρ = 2,65 g.cm ⁻³	σ = 0,26 nm
Si Substrate			