



HAL
open science

Characterization of ductile polymers at high-strain rates. Experimental and theoretical considerations

Noëlle Billon, Laurent Maurin, Y. Germain

► **To cite this version:**

Noëlle Billon, Laurent Maurin, Y. Germain. Characterization of ductile polymers at high-strain rates. Experimental and theoretical considerations. 1st international conference on mechanics on time dependent materials, Society for experimental mechanics, Sep 1995, Ljubljana, Slovenia. cea-04107220

HAL Id: cea-04107220

<https://cea.hal.science/cea-04107220>

Submitted on 26 May 2023

HAL is a multi-disciplinary open access archive for the deposit and dissemination of scientific research documents, whether they are published or not. The documents may come from teaching and research institutions in France or abroad, or from public or private research centers.

L'archive ouverte pluridisciplinaire **HAL**, est destinée au dépôt et à la diffusion de documents scientifiques de niveau recherche, publiés ou non, émanant des établissements d'enseignement et de recherche français ou étrangers, des laboratoires publics ou privés.

1st INTERNATIONAL CONFERENCE ON MECHANICS OF TIME DEPENDENT MATERIALS

SEPTEMBER 11-13, 1995,
LJUBLJANA, SLOVENIA



UNDER THE AUSPICES
OF THE SOCIETY FOR EXPERIMENTAL MECHANICS

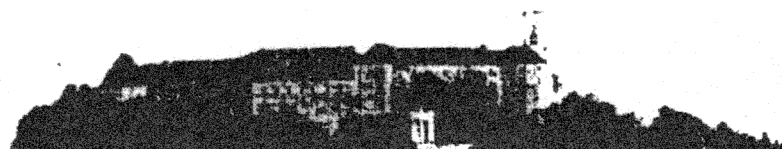

CHARACTERIZATION OF DUCTILE POLYMERS AT HIGH STRAIN-RATES. EXPERIMENTAL AND THEORETICAL CONSIDERATIONS.

N. BILLON*, L. MAURIN*, Y. GERMAIN**

* ENSMP-CEMEF, URA CNRS n° 1374, BP 207,
06904 SOPHIA-ANTIPOLIS CEDEX (FRANCE).

** ELF-ATOCHEM, CERDATO-LEM, 27 470 SERQUIGNY (FRANCE)

INTRODUCTION

Polymers are more and more often used for industrial applications where their impact resistance is of prime importance (e.g., automotive applications). For engineering design their mechanical behaviour has to be modelled with an accurate constitutive equation. As far as impact is concerned, this constitutive equation must take into account high strain-rates and multiaxial sollicitations.

Some polymers remain ductile even at high strain-rate (e.g., 100 to 1000 s⁻¹). They have to be modelled taking into account any of the phases of their deformation : viscoelastic, viscoplastic as well as strain-hardening phases.

Plastic deformation in polymers often results in a stable neck propagation. So, local measurements for strain and, consequently, "simple" loading conditions are necessary to analyze their mechanical behaviour.

In addition, plastic flow may induce heat dissipation whereas thermal conductivity of polymers is generally low. As mechanical behaviour of polymers may depend to a large extent on temperature, experimental determinations have to be performed at low strain-rates in order to avoid heating phenomenon.

Unfortunately, polymers are known to be very sensitive to strain-rates and loading conditions. Hence, usual experimental determinations are often not pertinent for high velocities and multiaxial sollicitations. So, rigorous characterizations of mechanical behaviour of polymers is only possible in an experimental range of sollicitations and velocities which are not representative for actual uses of industrial parts.

This study deals with an illustration of these difficulties in the case of a polypropylene.

EXPERIMENTAL PROCEDURE

An industrial polypropylene is used. This polymer is blended and compounded in order to improve its impact resistance. Its glass transition and melting temperature are - 1°C and + 150 °C, respectively. Samples are injection molded parts.

Tensile tests are performed on cylindrical hour-glass-shaped samples (Fig. 1a) which enable us to locate the initiation of the neck in the mid-plane (Fig 1b) of the sample, whereas stress and strain distributions remain axisymmetric (G'sell (1992)).

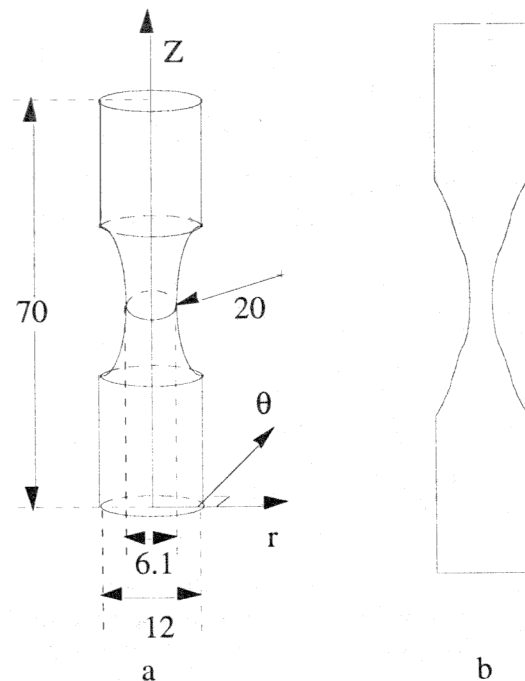

Fig 1: Shape of a tensile sample. a) Initial shape. b) Shape during tensile test when necking has occurred.

A Video-controlled tensile testing system (G'sell (1983)) enables us to determine the true strain in the sample, locally in the necking zone, during the entire test. In this device, a

video camera records the actual shape of the part of the sample where necking occurs. Local diameter, ϕ , and radius of curvature, ρ , are determined in the smallest section where the deformation is assumed to be homogeneous. True axial stress, σ_{zz} , and true axial strain-rate, $\dot{\epsilon}_{zz}$, are determined as a function of time, t :

$$\sigma_{zz} = \frac{4 F}{\pi \phi^2} \quad (1)$$

$$\dot{\epsilon}_{zz} = -\frac{2}{\phi} \frac{d\phi}{dt} \quad (2)$$

The material is assumed to be homogeneous, incompressible and isotropic. It obeys generalized von Mises' flow rule :

$$s_{ij} = \frac{2 \bar{\sigma}}{3 \dot{\bar{\epsilon}}} \dot{\epsilon}_{ij} \quad (3)$$

where s_{ij} and $\dot{\epsilon}_{ij}$ are the components of the deviatoric stress and strain-rate tensors, respectively.

$\dot{\bar{\epsilon}}$ is the equivalent strain-rate :

$$\dot{\bar{\epsilon}} = \sqrt{\frac{2}{3} \dot{\epsilon}_{ij} \cdot \dot{\epsilon}_{ij}} = \dot{\epsilon}_{zz} \quad (4)$$

The equivalent flow stress, $\bar{\sigma}$, (Bridgman (1949)) is then calculated as a function of σ_{zz} :

$$\begin{aligned} \bar{\sigma} &= \sqrt{\frac{3}{2} s_{ij} \cdot s_{ij}} \\ &= \sigma_{zz} \left[\frac{1}{\left[1 + 4 \frac{\rho}{\phi} \right] \ln \left(1 + \frac{\phi}{4\rho} \right)} \right] \quad (5) \end{aligned}$$

During the tests, the strain-rate can be maintained constant in the necking zone, up to a maximum value of 10^{-3} s^{-1} . At higher strain-rates it is measured during tests performed at constant cross-head velocities.

RESULTS FOR LOW STRAIN-RATES

This polypropylene exhibits a typical behaviour for a ductile polymer (Fig 2) with an important plastic flow and an important strain-hardening process.

The behaviour of this polymer clearly depends on strain-rate (Fig 2).

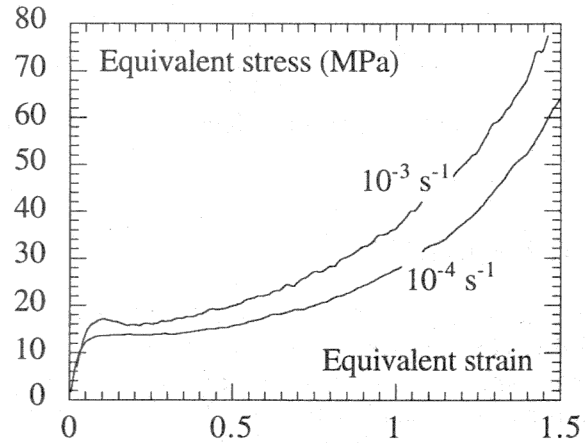

Fig 2: Experimental evolution of the equivalent stress versus the equivalent strain at 25 °C for two strain-rates : 10^{-4} and 10^{-3} s^{-1} .

This kind of behaviour is often well modelled using a phenomenological equation, first proposed by G'sell and Jonas (G'sell (1979), G'sell (1983), Duffo (1995)), including elastic deformation as well as plastic flow and stable neck propagation. :

$$\bar{\sigma} = K_p (1 - \exp(-W \bar{\epsilon})) \exp(h \bar{\epsilon}^p) \dot{\bar{\epsilon}}^m \quad (6)$$

where $\bar{\epsilon}$ is the equivalent strain also called cumulated strain :

$$\bar{\epsilon} = \int_0^t \dot{\bar{\epsilon}} dt \quad (7)$$

The term W is introduced to take into account viscoelastic deformation at the beginning of the drawing (strain lower than 0.1). K_p is a scale factor called consistency. h and p are coefficients related to strain-hardening process, whereas m characterizes a typical viscoplastic flow.

In fact, the behaviour of the polymer also largely depends on temperature (Fig 3), T . This can be taken into account using an Arrhenius equation for consistency K_p :

$$K_p = K \exp\left(\frac{a}{T}\right) \quad (8)$$

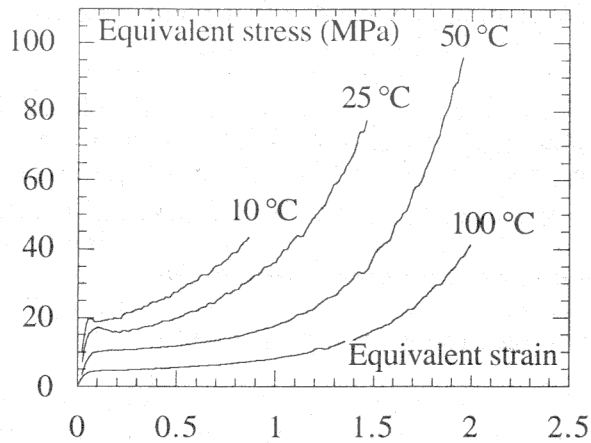

Fig 3: Experimental evolution of the equivalent stress versus the equivalent strain during drawings at different temperatures (10, 25, 50 and 100 °C). The strain-rate is 10^{-3} s^{-1} .

Rheological parameters are determined during experiments performed at constant strain-rates ranging from $3.2 \cdot 10^{-5}$ to 10^{-3} s^{-1} and temperatures ranging from 10 °C to 100 °C. Results are given in table 1.

To be rigorous it must be emphasized that the chosen thermodependence for the equivalent stress is not satisfactory: m should depend on temperature.

Despite this, coefficients written in table 1 allow to reproduce experiments performed below 60 °C with a good agreement (Fig 4) up to 10^{-3} s^{-1} .

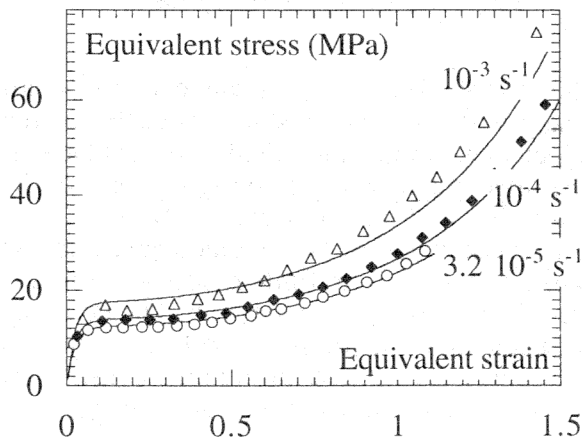

Fig 4: Evolution of the equivalent stress during tensile tests performed at 25 °C and three constant strain-rates ($3.2 \cdot 10^{-5}$, 10^{-4} and 10^{-3} s^{-1}). Comparison between experimental results (symbols) and calculations (—) using equations (6) and (8) and data given in table 1.

K MPa s ^m	a K	W	h	p	m
0.04583	1977	41	0.65	2	0.1

Table 1: Rheological parameters determined at strain-rates ranging from $3.2 \cdot 10^{-5}$ to 10^{-3} s^{-1} .

MODERATE STRAIN-RATES

Previous parameters do not allow to model a wide range of strain-rates. Let us now consider tests performed at 25 °C and at constant cross-head velocities: 0.5, 1, 2, 4, 8 and 16 mm/min. During these experiments strain-rates are not constant but can be measured in the smallest section of the sample (Fig 5) using the video-controlled tensile system. In the same manner, true stress is measured as a function of true strain. Coefficients given in table 1 do not enable to reproduce these experiments. The higher the velocity, the worse the agreement.

Taking into account experiments performed at 10^{-3} s^{-1} and four of the latter tensile tests (0.5, 1, 2 and 4 mm/min) it is possible to determine new values for m , h , p and K_p (Table 2). K is calculated assuming that a does not vary.

K MPa s ^m	a K	W	h	p	m
0.02116	1977	41	0.921	1.46	0.042

Table 2: Rheological parameters determined at constant cross-head velocities ranging from 0.5 to 4 mm/min.

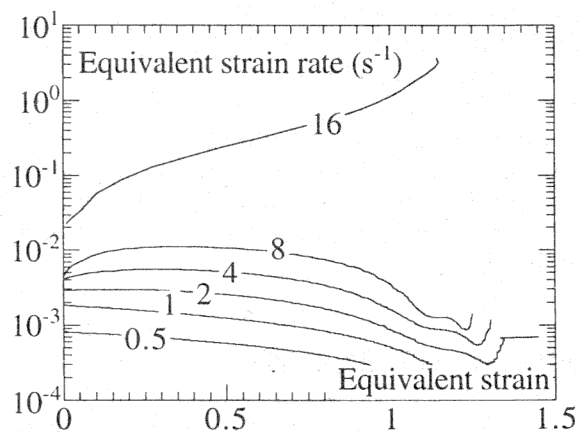

Fig 5: Equivalent strain-rate in the necking zone during tensile tests at different constant cross-head velocities (16, 8, 4, 2, 1, 0.5 mm/min).

It is then possible to reproduce experiments performed at velocities up to 8 mm/min (Fig 6).

It must be noticed that this last experiment was not taken into account to determine the parameters.

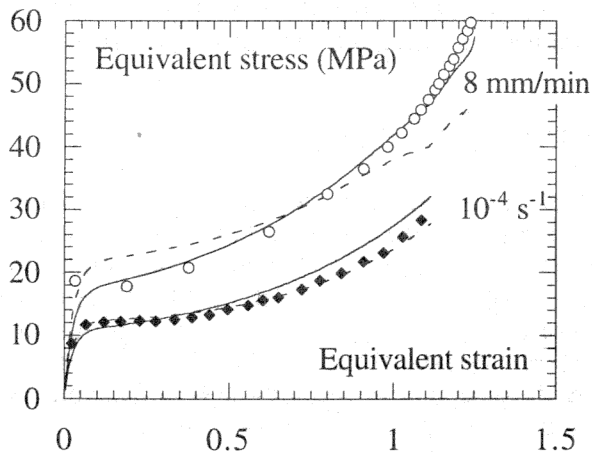

Fig 6: Evolutions of the equivalent stress versus the equivalent strain in two cases : strain-rate of 10^{-4} s^{-1} and cross-head velocity of 8 mm/min. Comparison between experiments (symbols) and calculations using data given in table 1 (- - -) and calculations using data given in table 2 (—).

At this stage we have determined two sets of rheological parameters : one which is valid at very low strain-rates (lower than 10^{-3} s^{-1} , Fig 6, 10^{-4} s^{-1}) and one which is valid at higher strain-rates (Fig 6, 8 mm/min, 10^{-2} s^{-1}).

These two sets are significantly different, especially concerning the sensitivity to strain-rate and strain (m and h and p , respectively).

The accuracy of each of these sets depends on the strain-rate (Fig 6). Constitutive equation obtained at very low strain-rates is not accurate for higher strain-rates whereas data determined at higher strain-rates could lead to a reasonable agreement at low strain-rates. In other words, low strain-rates experiments are not pertinent. Measurements should be more accurate at high strain-rates.

HIGHER STRAIN-RATES

Unfortunately, high strain-rates tensile tests lead do heat dissipation and experiments do not remain isothermal.

Let us consider now a tensile test performed at 16 mm/min. In our case (Fig 5) the strain-rate in the necking zone is higher than 10^{-2} s^{-1} . It is then necessary to take into account heat

dissipation. To achieve that point we have to use numerical simulation of the test.

The model is a finite element code developed in our laboratory to model deformation of homogeneous, incompressible thermo-viscoplastic materials (FORGE2®). The equilibrium equations are obtained by minimization of a dissipation functional, with respect to velocity. Incompressibility is enforced using a penalty method.

The temperature within the polymer is calculated taking into account energy dissipation, thermal conductivity of the polymer as well as thermal exchanges with metallic clamping devices and surrounding air. Conservation of energy assumes a Fourier conduction and involves three new physical parameters : d , the density, C_p , the heat capacity and k , the thermal conductivity of the polymer which are given in table 3. Exchanges with the air involve both convection and radiation phenomena. When the polymer is in contact with metallic tools conduction is taken into account. Both the air and the metal are supposed to be isothermal. A Galerkin method is used to calculate temperatures in the polymer.

d kg m^{-3}	C_p $\text{J kg}^{-1} \text{K}^{-1}$	k $\text{W m}^{-1} \text{K}^{-1}$
820	2380	0.2

Table 3: Parameters used to calculate the evolution of the temperature during mechanical tests.

The calculations are performed using small steady-like deformation steps. At each step the velocity and temperature fields are calculated as described above. So, the configuration and the velocity field are known at time t . The configuration at time $t+\Delta t$ is calculated using an explicit scheme. The finite element method is used for the space discretization. The coupling between the mechanical and the thermal problems is performed through the consistency dependence on temperature (Equation (8)).

Calculations show that, during a tensile test performed at 16 mm/min, the temperature in the necking zone of the sample may increase up to 35 °C. As shown in figure 3, this evolution may induce significant modifications in the behaviour of the material and must be taken into account. On the other hand, m was found to remain constant between 25 °C and 35 °C.

As a consequence, we only consider the evolution of the consistency K_p in our calculations.

At a cross-head velocity of 16 mm/min, calculated stresses are in good agreement with experiments provided that calculations use parameters given in table 2, that is, parameters which were determined at moderate strain-rates.

Despite this, it remains difficult to reproduce correctly tensile experiments at higher strain-rates. This was already pointed out with other polymers such as polycarbonate or polyamide 12 (Schang (1995)). Constitutive equation determined at low strain-rates does not allow to reproduce tensile tests performed at high strain-rates. This is particularly true in that case since a set of constant parameters does not enable to model the behaviour over a range of strain-rates wider than three decades

Seemingly, this is partly due to the fact that equation (6) is not totally accurate for polymers. But this equation remains a good approximation provided that its parameters have been correctly determined.

The above considerations demonstrate that accurate measurements should be performed at strain-rates as high as possible. Unfortunately, experiments are no more isothermal above 0.01 s^{-1} and elaborate inverse methods should be developed in order to determine rheological parameters.

APPLICATION TO IMPACT

Multiaxial impact test is used here as a way to promote high strain-rate multiaxial loading conditions.

This test consists in the drop of a hemispherical striker on a circular plaque held by a clamping force. The diameters of the striker and the plaque are 2 and 6 cm, respectively. The plaque is held on 1 cm all around its circumference. So, the deformation occurs in a 4 cm diameter circular zone of polymer. The sample is maintained between two scratched metallic parts. The upper one is firmly screwed on the other to ensure the clamping. The polymer is a two millimeters thick injection-molded plaque. The strength on the striker is measured as a function of time, using a piezoelectrical device.

It was already pointed out that friction between the striker and the polymer is of prime importance (Maurer (1989), Billon (1992)). This phenomenon may modify the location of the deformation and the evolution of the strength during impact. Consequently, we have considered impacts where the striker has been lubricated in order to minimize friction effects.

As a first step, tests are performed at low impact velocities (e.g., 0.27 mm/s). In that case, the calculated strain-rate is about 0.02 s^{-1} that is, a value which would correspond to a tensile test at a velocity higher than 8 mm/min but lower than 16 mm/min (Fig 5).

It is possible, using FORGE2[®], to model this test (Billon (1992)). The beginning of the evolution of the strength during impact is rather well modelled using data given in tables 1 and 2. Parameters determined at higher strain-rates seem to be more accurate. Nevertheless, both these two calculations are not accurate at high displacement. In fact, as already observed (Schang (1995)), due to the difference in the loading geometry, microstructural evolutions of the polymer are very different during impact and during drawing. This results in an important difference in the strain-hardening process. Consequently, strain-hardening factors, h and p , as determined during uniaxial tensile tests, over-estimate hardening during impact. They have to be lowered.

Better agreement is obtained using data given in table 4 (Fig 7).

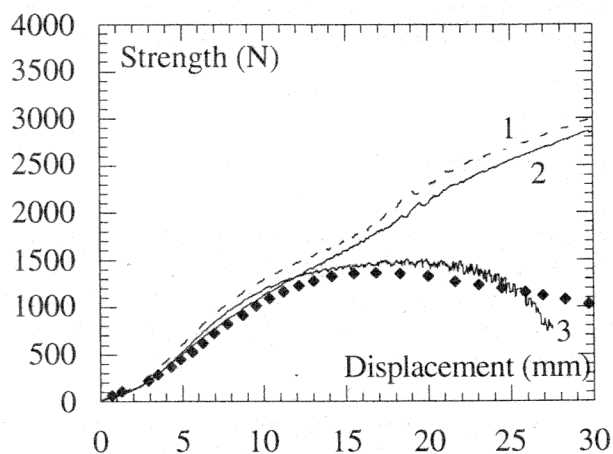

Fig 7: Evolution of the strength versus the displacement during an impact at 0.27 mm/min. Comparison between experimental results (symbols) and calculations (—) using data given in table 1 (1), table 2 (2) and table 4 (3).

These conclusions remain true for impact at higher impact velocity (e.g., 2300 mm/s, that is, approximately 200 s^{-1}) (Fig 8) :

- * low strain-rate parameters are inaccurate,
- * higher strain-rate parameters are more pertinent but inaccurate at high deformation,
- * strain-hardening factor must be decreased in order to fit experiment,
- * data given in table 4 lead to a good agreement with experiment.

K MPa s ^m	a K	W	h	p	m
0.0359	1977	29	0.65 - 0.15 $\bar{\epsilon}$	2	0.06

Table 4: Rheological parameters determined during an impact at 0.27 mm/min .

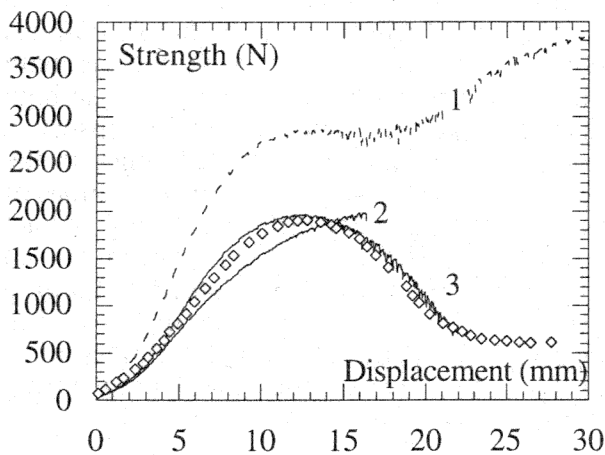

Fig 8: Evolution of the strength versus the displacement during an impact at 2300 mm/min. Comparison between experimental results (symbols) and calculations (—) using data given in table 1 (1), table 2 (2) and table 4 (3).

CONCLUSION

Characterizations of the mechanical behaviour of polymers performed at low strain-rates are inaccurate to model impact properties because of the strain-rate and the strain-hardening effects.

The chosen constitutive equation seems to be partly inaccurate. Nevertheless, it remains a good approximation provided that its parameters are determined in conditions close to the actual sollicitation.

The use of measurements performed at drawing velocities as high as possible seems to be more

accurate to determine rheological parameters. However, measurements must still be performed at a rate lower than 0.01 s^{-1} due to heat dissipation. This value remains far from actual strain-rates observed during an impact. Inverse methods should be developed in order to use experiments at higher strain-rates.

The main problem remains the microstructural evolutions in the polymer which are very sensitive to the loading conditions and which may induce significantly different strain-hardening processes.

Nevertheless, using low velocity impact it is possible to modify rheological parameters in order to get a better agreement with experiment.

This modification is validated with high speed tests (e.g., modelling of an impact at 2300 mm/min using data obtained during an impact at 0.27 mm/min). To achieve this point, numerical simulation of impact test is used.

So, by combining numerical simulations and experiments it is possible to get accurate rheological parameters for impact.

This kind of determination may be long and tedious. Inverse methods should be also useful in that field.

REFERENCES

- Billon N., Haudin J.M. (1992). Proc. Int. Conf. NUMIFORM (Sophia-Antipolis), 335.
- Bridgman P. W. (1949). Trans. Amer. Soc. Metals, 32: 553.
- Duffo P., Monasse B., Haudin J. M., G'Sell C., Dahoun A. (1995). J. Mater. Sci., 30 :701.
- G'Sell C., Hiver J.M., Dahoun A., Souahi A. (1992). J. Mater. Sci., 27: 5031.
- G'Sell C., Jonas J. J. (1979). J. Mater. Sci., 14 : 583
- G'Sell C., Aly-Helal N. A., Jonas J. J. (1983). J. Mater. Sci., 18: 1731.
- Maurer G., von Berstorff B., Richter R., Breuer H. (1989). Kunststoffe, 79 : 1317.
- Schang O., Muracciole J.M., Fernagut F., Billon N. (1995). Polym. Eng. Sci. to appear