



**HAL**  
open science

## Development of instrumentation for eddy current in-situ monitoring of Laser Powder Bed Fusion

N. Sergeeva-Chollet, K. Perlin, M. Pellat

► **To cite this version:**

N. Sergeeva-Chollet, K. Perlin, M. Pellat. Development of instrumentation for eddy current in-situ monitoring of Laser Powder Bed Fusion. *Welding in the World*, 2023, 67, pp.1105-1112. 10.1007/s40194-022-01456-5 . cea-04089789

**HAL Id: cea-04089789**

**<https://cea.hal.science/cea-04089789v1>**

Submitted on 15 Nov 2023

**HAL** is a multi-disciplinary open access archive for the deposit and dissemination of scientific research documents, whether they are published or not. The documents may come from teaching and research institutions in France or abroad, or from public or private research centers.

L'archive ouverte pluridisciplinaire **HAL**, est destinée au dépôt et à la diffusion de documents scientifiques de niveau recherche, publiés ou non, émanant des établissements d'enseignement et de recherche français ou étrangers, des laboratoires publics ou privés.

# Development of instrumentation for eddy current in-situ monitoring of Laser Powder Bed Fusion

N.Sergeeva-Chollet<sup>1</sup>, K. Perlin<sup>1</sup>, M. Pellat<sup>2</sup>

<sup>1</sup> Université Paris-Saclay, CEA, List, F-91120, Palaiseau, France

<sup>2</sup> Université Grenoble Alpes, DTNM, LITEN, CEA, F-38000, Grenoble, France

Corresponding author: [natalia.sergeeva-chollet@cea.fr](mailto:natalia.sergeeva-chollet@cea.fr) ORCID: 0000-0001-9640-2626

## Abstract

The Laser power bed fusion (L-PBF) additive manufacturing process is commonly used for fabrication of complex metal parts. To ensure the parts' quality, monitoring of the manufacturing process by an instrument operating continuously during the manufacturing process should be carried out. The existing industrial solutions are limited in the sense that they are restricted to the detection of anomalies within machine state parameters or in the surface layers of the part under construction. Eddy current testing is a promising non-destructive testing method that could be applied for the layer-by-layer inspection of fused material during part fabrication. This inspection enables to follow the defects evaluation not only on the surface of the last fused layer but at the scale of the several fused layers. An eddy current sensor has been developed and adapted to perform measurements in a L-PBF machine during the manufacturing phase (in-situ). The performance and potential of the technique in terms of robust integration in the machine and defects evaluation have been studied. The obtained results allowed to evaluate the detection limits according to the width and the height of the defects during the manufacturing of the part. The influence of the powder presence around the fused area has also been studied.

## Keywords

in-situ monitoring, L-PBF, non-destructive testing, Eddy current

## 1 Introduction

The Laser power bed fusion (L-PBF) additive manufacturing process is commonly used for fabrication of complex metal parts for different applications like aeronautics or medical application for example [1,2]. The metal parts are produced by fusing the metal powder layer by layer with a laser beam saving the quality of base material. Thus, it enables the fabrication of complex geometry pieces. The quality of parts in terms of their mechanical properties could be influenced by the presence of different types of defects due to slight difference of the fabrication process (temperature, local change of powder properties, speed, laser intensity changing). At the end of the fabrication process, the quality of final parts is controlled by non-destructive testing in order to verify their integrity. If the defects upper acceptance barrier is found during this quality control, the part should be rejected. In order to have the possibility to repair immediately after the defect detection or to change the fabrication process parameters to ensure the parts' quality, monitoring of the manufacturing process should be carried out. The existing solutions (thermography, laser diode, pyrometer) are limited in the sense that they are restricted to the detection of anomalies within machine state parameters or in the surface layers of the part under construction [3, 4, 5].

Eddy current testing (ET) is a promising non-destructive testing method that could be applied for the layer-by-layer inspection of fused material during part fabrication. This inspection is non-contact and enables to follow the defects evaluation not only on the surface of the last fused layer but at the scale of the several fused layers. Previous studies have shown the possibility of the application of this technique with commercially available sensors [6, 7]. Also the evaluation

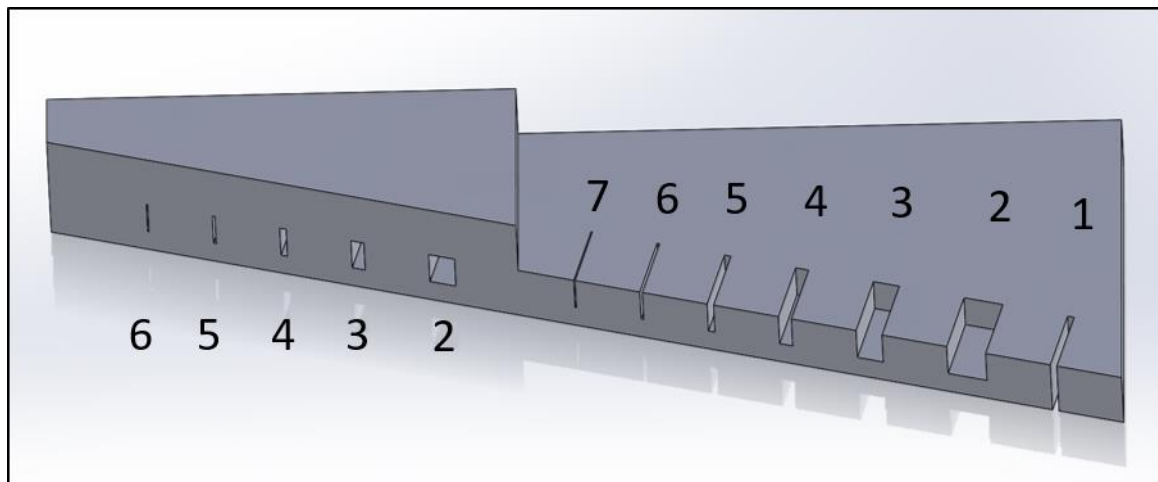
of the method has been made for the in-situ estimation of relative density of the manufactured parts [8]. Eddy current (EC) sensors based on magnetoresistive sensors have been developed and evaluated on artificially introduced defects in L-PBF manufactured sample [9].

In this study an eddy current sensor has been developed and adapted to perform measurements in a L-PBF machine during the manufacturing phase (in-situ). The performance and potential of the technique in terms of robust integration in the machine and defects layer-by-layer evaluation have been studied. The obtained results allowed to evaluate the detection limits according to the width and the height of the defects during the manufacturing of the part. The influence of the powder presence around the fused area has also been studied.

## 2 Methods and discussion

### 2.1 Process and materials

Computer aided design (CAD) of the part with different notches has been designed for evaluation of defects detectability during part fabrication. A part with long defects with different widths has been designed in order to assure that the sensor could pass at the defect area. The detection limits according to the width and height of defects has been aimed for evaluation. The part dimensions are 80 x 40 x 5 mm (10 mm) (length x width x height of the first step (height of second step)). The part has been manufactured using AlSi7Mg powder provided by Toyal FS271 M in L-PBF Farsoon machine using CAD file. Main process parameters are as follows : laser power = 200 W, scan speed = 1000 mm/s, hatch = 0,17  $\mu$ m, layer thickness = 30  $\mu$ m. The part has been fabricated onto build plate. The part design with two steps and different defect is shown in **Fig. 1**, here the half cut of part is presented for better visualization of defects inside the part. The defects description is presented in Table 1. The defects are characterized by their length, width and height.



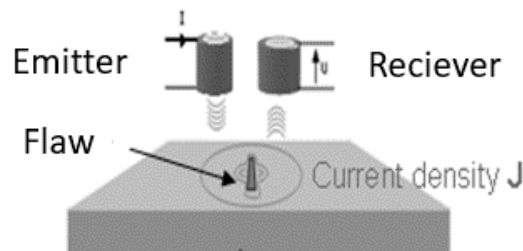
**Fig. 1** Cut of CAD of fabricated part

**Table 1** Defects description

Defect	Length (mm)	Width (mm)	Height (mm)
1	10	0.5	5
2	10	3	3
3	10	2	3
4	10	1	3
5	10	0.5	3
6	10	0.2	3
7	10	0.1	3

## 2.2 Eddy current principle

Eddy current testing (ECT) is widespread, ensuring sub-jacent or surface-breaking defects detection. This technique consists in creating, in conductive materials, currents induced by a variable magnetic field with the help of sensor. Eddy current sensor is composed of emitter and receiver, which are winding coils in general. The emitter is excited with alternative current with predefined frequency and amplitude which will create variable in time electromagnetic field. This field induces eddy currents in conducting part under test. Perturbation of Eddy current distribution due to the presence of defect, inhomogeneity or change in geometry, modifies the magnitude of the reaction field. This modification will be detected by receiver. This principle of ECT is illustrated in **Fig. 2**.

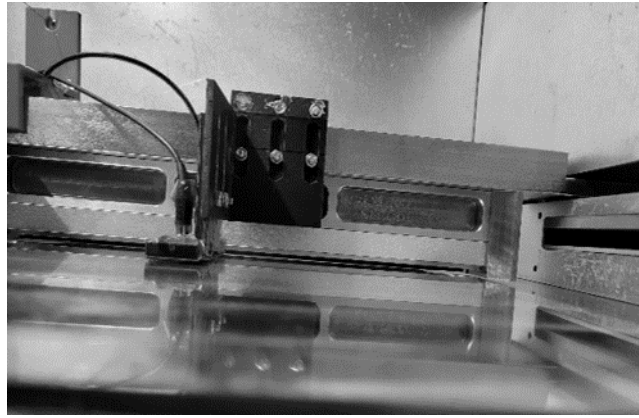


**Fig. 2** Eddy current testing principle

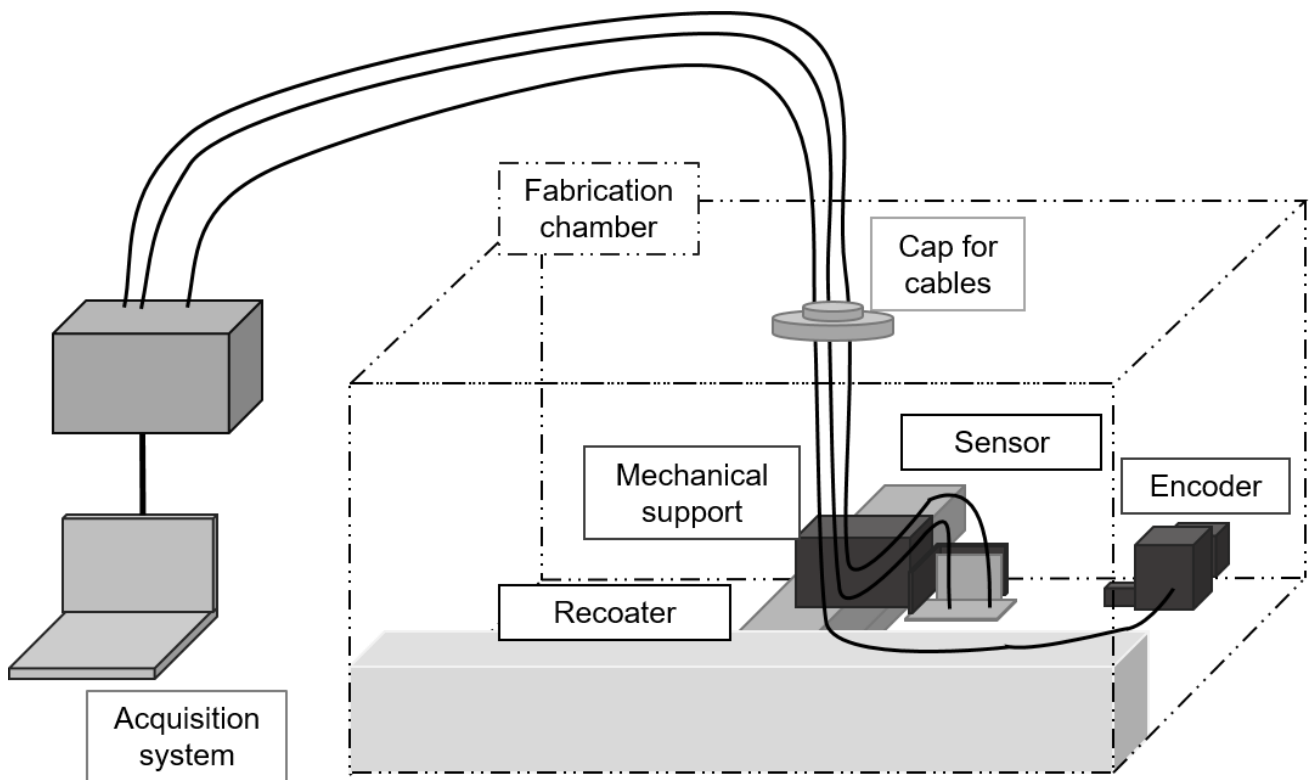
## 2.4 Measurement equipment

The selected sensor is composed of two coils of diameter of 3 mm with overlap and operates in emitter/receiver separated mode. This mode means that one coil is used for excitation and another one for the reception of the signal from the part under test. Frequency choice  $f = 1$  MHz is made in order to concentrate eddy currents on the surface of the part under test and to have less sensitivity to non-fused metallic powder around the part during manufacturing. Standard acquisition EC system of Eddyfi [10] has been used for the in-situ measurements.

The sensor has been mounted on the recoater using developed mechanical support (**Fig. 3**). The measurements are realized after laser fusion on the way back of the recoater. Wire encoder has been installed in the fabrication chamber. It has been connected to acquisition system in order to map the signal from the sensor and its position during acquisitions. Due to developed mechanical support, the constant lift-off of  $0.3\mu\text{m}$  has been obtained. The cables were passed in a hole in the machine with specially developed and adapted cap to ensure hermeticity of the fabrication chamber. Installation principle is illustrated in **Fig. 4**.



**Fig. 3** Mechanical support for EC sensor fixation on recoater of Farsoon machine



**Fig. 4** Installation of EC system for in-situ monitoring

### 3. Results and discussion

#### 3.1. Powder influence

To study the powder influence on the measurements of the part under manufacturing, the described above set-up has been used. The excitation frequency is  $f = 1 \text{ MHz}$ . The applied voltage is  $V = 8 \text{ V}$ . First, the signal from the built plate and powder in powder feeder has been measured (**Fig. 5**). The difference between two zones is observed, that corresponds to the sensitivity of the sensor to the metal part. The first layers of powder of the height of  $30\mu\text{m}$  have been deposited and fused. Then the signal after deposition of 10 layers of the manufacturing part has been measured on the whole way of recoater, i.e. built plate covered by non-fused powder, fused part and powder feeder. **Fig. 6** shows the ECT data with the presence of powder on the built plate, fused part under manufacturing and powder feeder. The dashed contoured part corresponds to the fused part. In the same figure the zoomed area without the signal from powder feeder is shown. The

dashed contoured part also indicates the fused area. It is observed that there is always the difference between the signal signature from the powder tray and from the built plate covered by powder. However, no influence of the close presence of metal powder to the fused part is observed starting from 10 fused layers. The extremities of the part under fabrication are well distinguished.

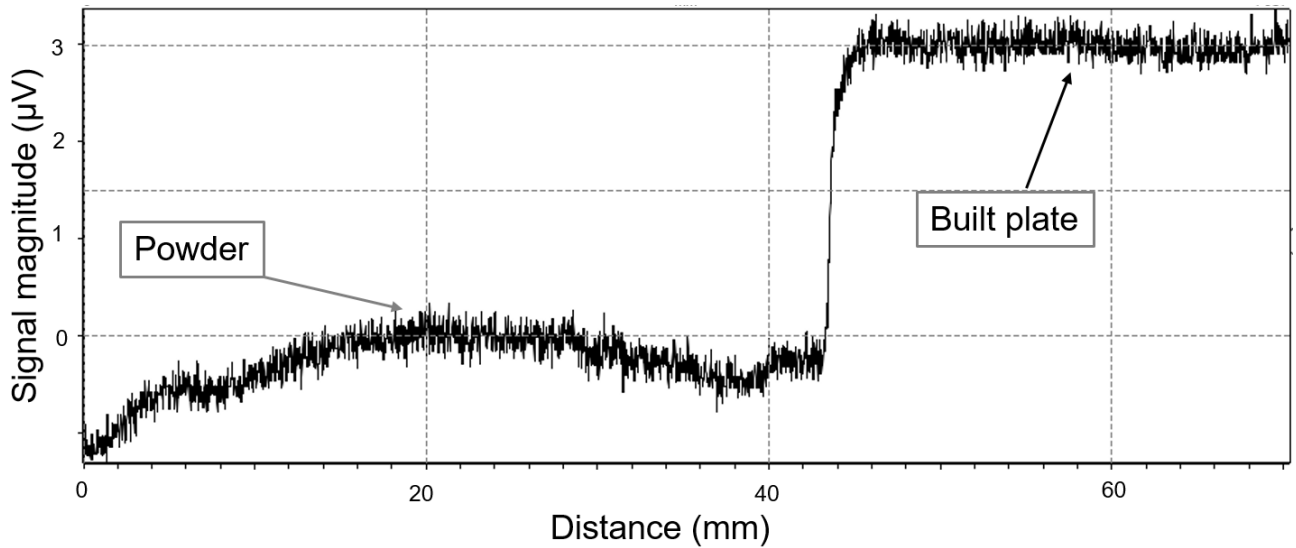


Fig. 5 Experimental results obtained with EC sensor, EC signal from built plate and powder feeder

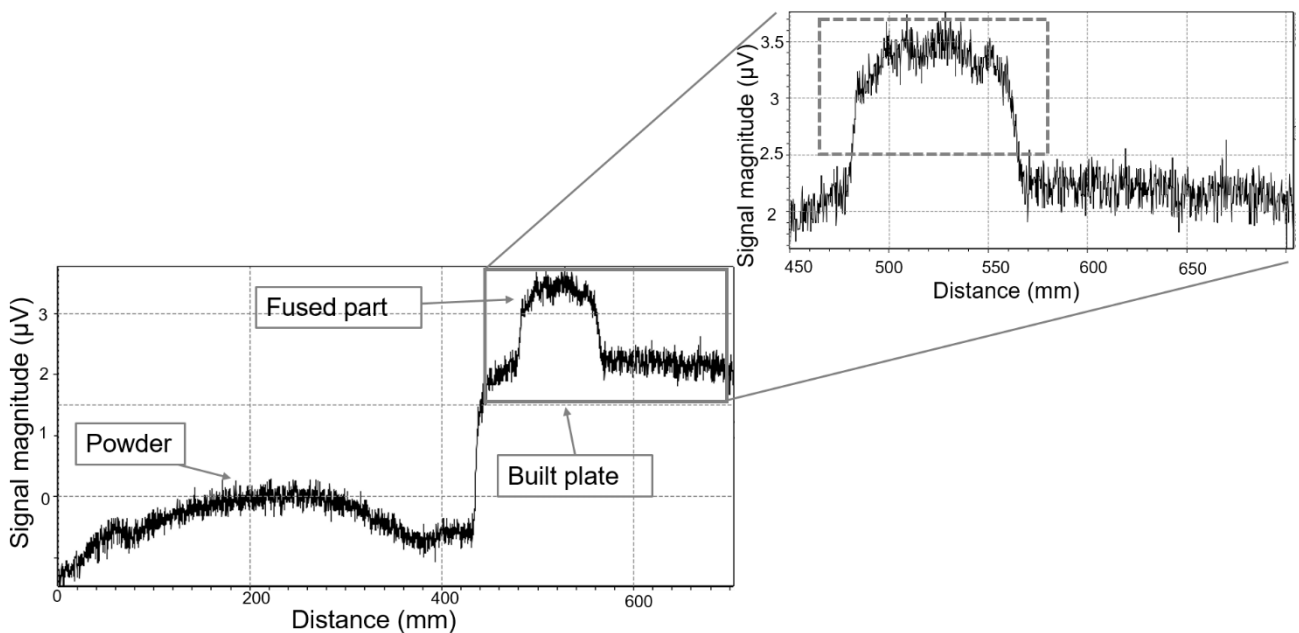
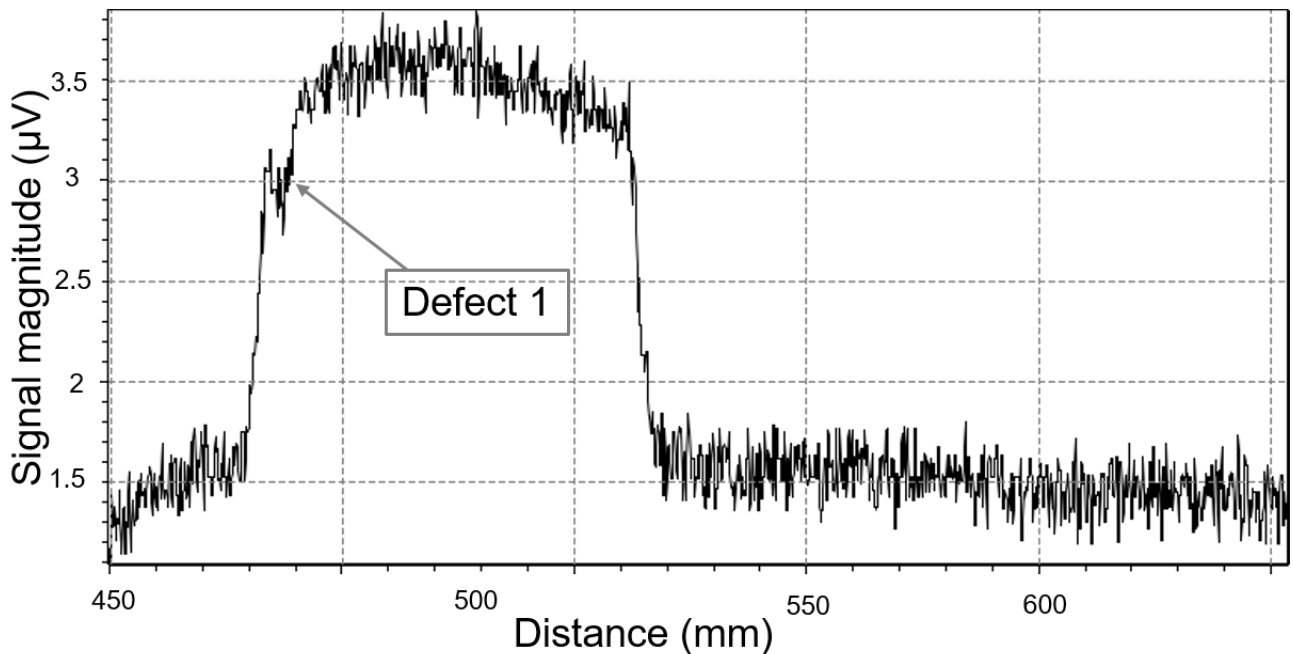


Fig. 6 Experimental results obtained with EC sensor, EC signal from built plate, fused area and powder feeder after 10 layers fusion

### 3.2 Defects detection

For the defects detection the measurements have been continued with the same parameters for the sensor. The acquisitions has been realized after deposition of each 5 layers on the way back of the recoater. The results have been registered and analysed in Civa software [11]. The defect 1 has the height of 5 mm, equal to the height of the first step of

the part. After deposition and fusion of 10 powder layers this defect is not detected, however during the acquisition after 15 deposited and fused layers it is clearly observed despite the roughness of the part surface (**Fig. 7**).

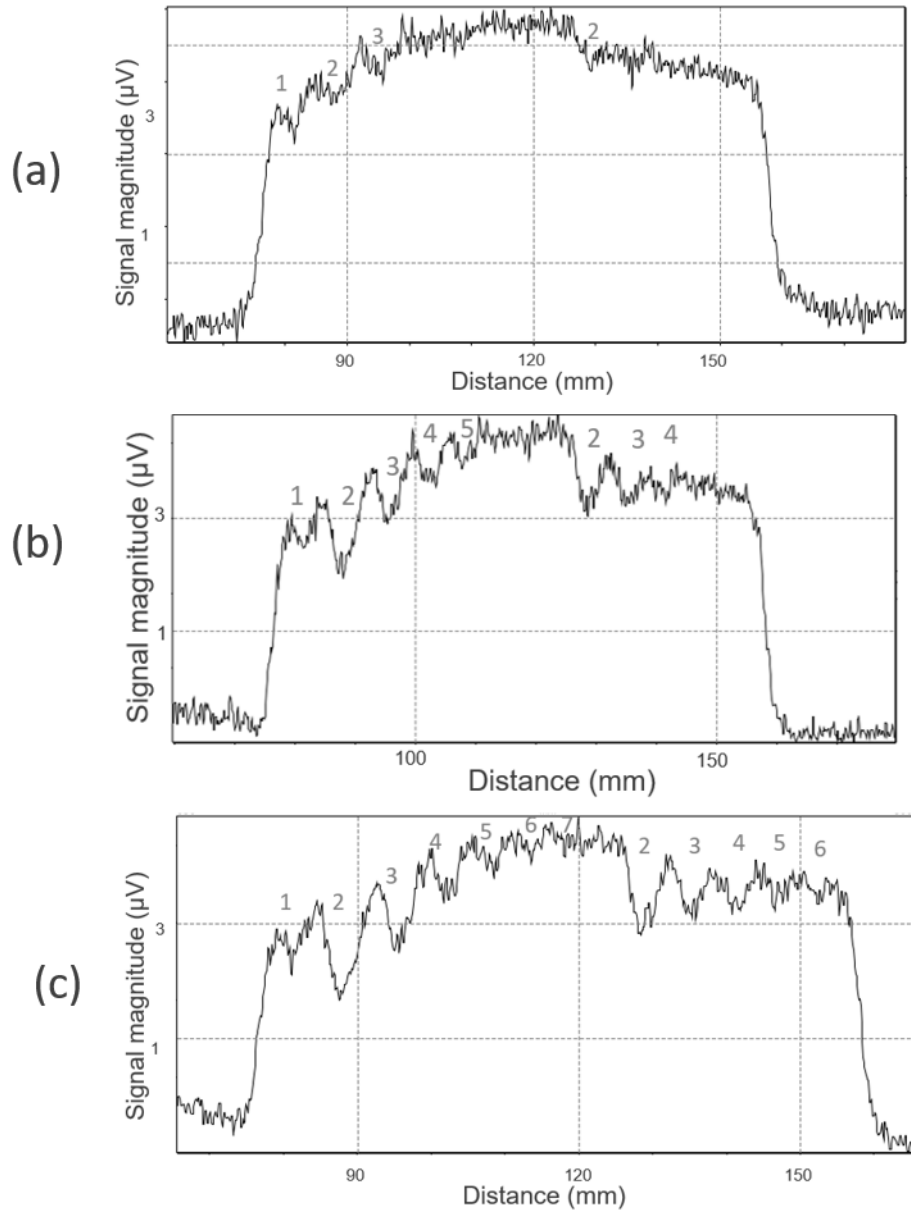


**Fig. 7** EC signal after 15 powder layers deposition and fusion, detection of defect with the width of 0.5 mm in the part under manufacturing

ECT acquisitions are made after each 5 deposited layers. The defects formation should start at layer 67, this number of deposited layers corresponds to the part height of 2.0 mm. From this height the defects should occurred in the fabricated part according to CAD file. The measurements have been realized at this layer and then after deposition and fusion of every 5<sup>th</sup> layer. The detectability according to defects' width and height during the fabrication of the part is evaluated. At layer 72, i.e. at the height of 2.16 mm of the fabricated part, the defects 2 and 3 of the width of 3 mm and 2 mm and the height of  $\sim 160\mu\text{m}$  for this number of fused layers are detected in addition to the defect of the width of 0.5 mm with the height of the fused part (**Fig. 8** (a)). Starting from layer 77, defect 4 with the width of 1 mm could be distinguished.

The defect 4 of the width of 1 mm and defect 5 with the width of 0.5 mm can be detected starting from 87 deposited layers, corresponding to the part height of 2.6 mm (**Fig. 8** (b)). This height corresponds to the defect height of  $\sim 0.6$  mm.

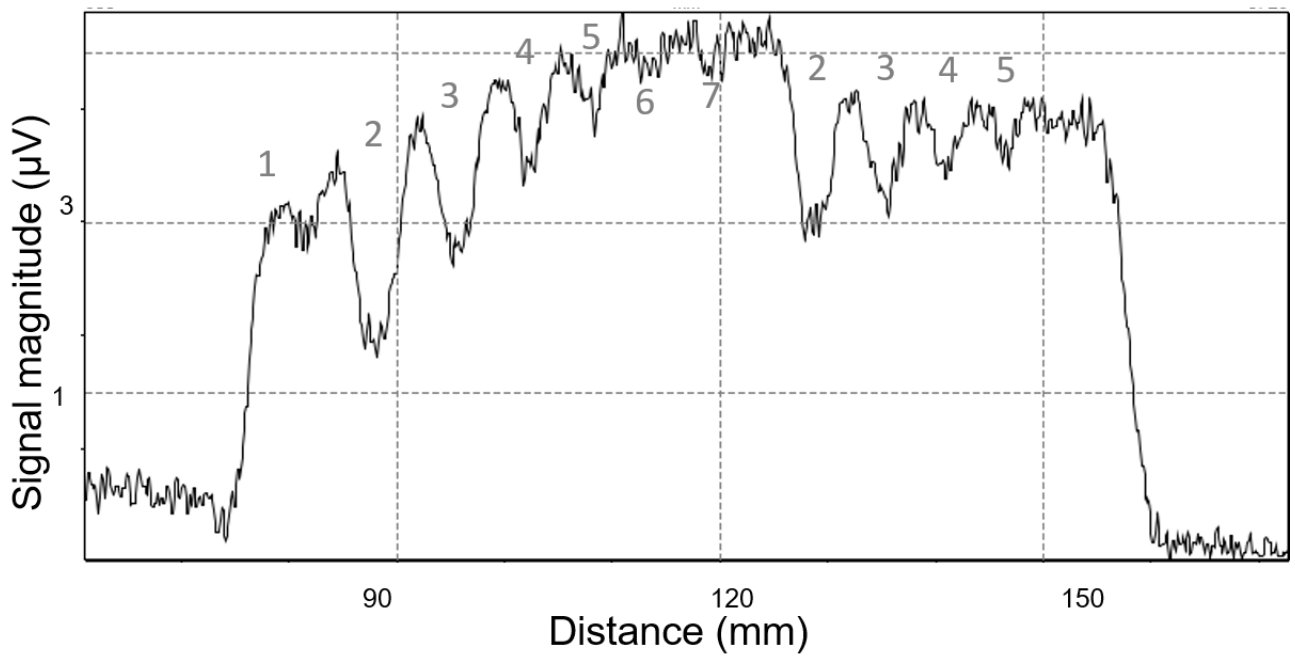
Starting from layer 97, part height of 2.9 mm, all defects are detected (**Fig. 8** (c)). Defect 7 of the width of 0.1mm is in the limits of detection for this height. It is observed that the magnitude of the signal from the defects with more important height and width is higher as in specimen from solid materials, thus the influence of the powder inside the defects on the detectability is not very important.



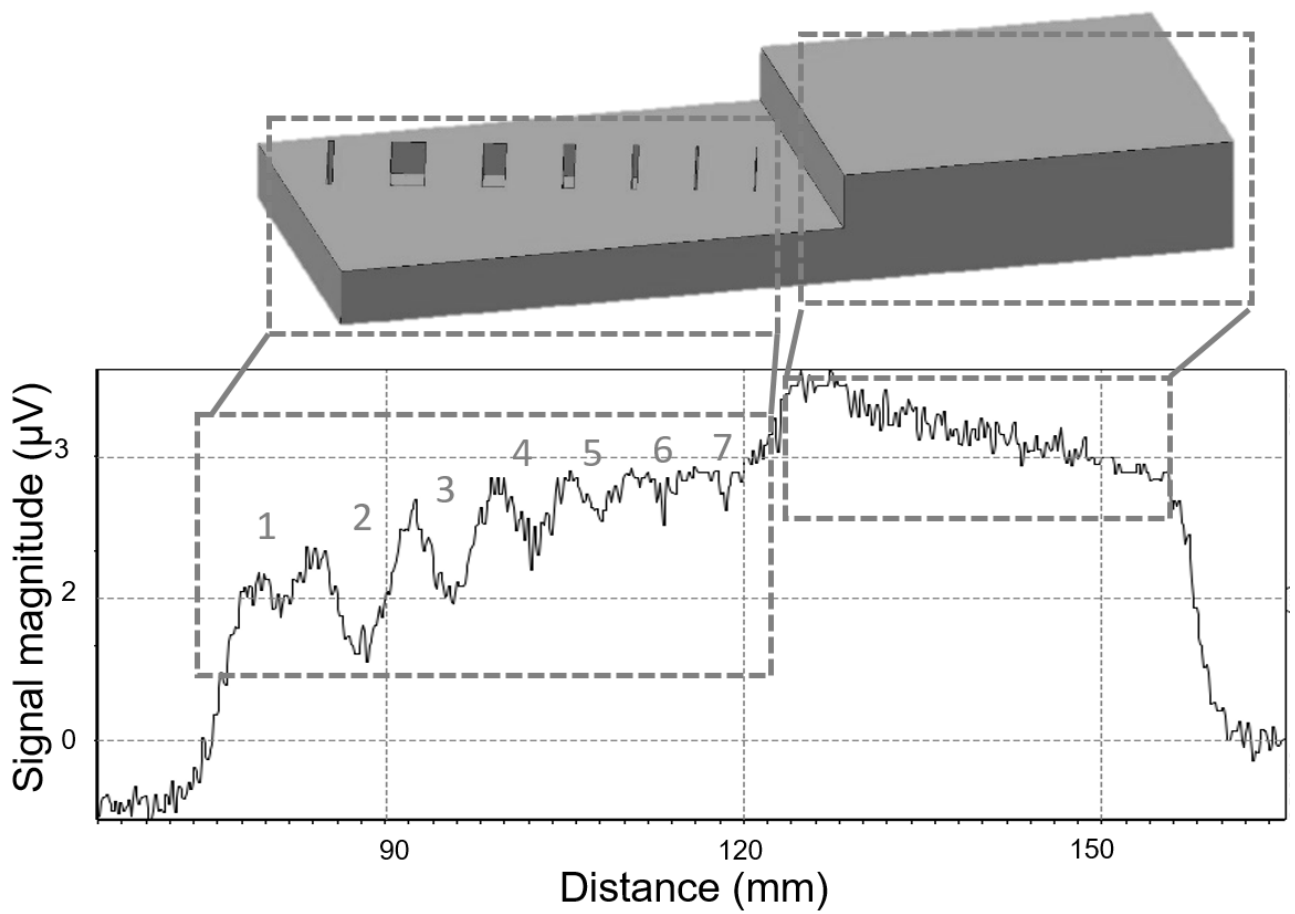
**Fig. 8** EC signal (a) after 72 powder layers deposition and fusion, detection of defects 1, 2 and 3 with the width of 0.5 mm, 3 mm and 2 mm (b) after 87 powder layers deposition and fusion, detection of defects 1, 2, 3, 4 and 5 with the width of 0.5 mm, 3 mm and 2 mm, 1 mm and 0.5 mm (c) after 97 powder layers deposition and fusion, detection of all defects 1, 2, 3, 4, 5, 6 and 7 with the width of 0.5 mm, 3 mm and 2 mm, 1 mm, 0.5 mm, 0.2 mm and 0.1mm in the part under manufacturing.

After the manufacturing of the first step of the part, one supplementary layer has been deposited, thus one layer of fused powder is situated above the defects in the area of the second step. All defects are still detected (**Fig. 9**). Nevertheless, after deposition and fusion of 5 next layers no indication of the defects in the area of the second step has been observed. The excitation frequency of 1 MHz is not sufficiently low for the detection of defects situated at 180 µm below the surface in the fused area. However, the defects covered with the non-fused powder are still detected (**Fig. 10**).





**Fig. 9** EC signal from the part after manufacturing after first step fusion and deposition and fusion of 1 layer of the second step of the part (165 layers).



**Fig. 10** EC signal from the part after manufacturing after first step fusion and deposition and fusion of 6 layers of the second step of the part (170 layers).

### 3.3. Discussion

This study has demonstrated that there is no influence of the powder around the part under manufacturing on the ET measurements because of the lower conductivity than the fused area at chosen excitation frequency for the EC sensor. The same conclusion was found in the study of Ehlers et al. with the EC sensors based on magnetoresistive sensors [9]

Surface breaking defects with the width of the order of 100 $\mu$ m can be detected. Thus, developed EC sensor can be considered as a good candidate for the detection of the real defects that might occur during L-PBF manufacturing, as the defects, like porosity or lack of fusion; dimensions are of the same order. The width of the defects could slightly vary from layer to layer because of the machine functioning, thus the estimation the width of defects can be different at different moments of fabrication.

Detectability of defects is shown in Table 2. The formation of defects has been followed during the fabrication of part, thus it is possible to study starting from which minimal height the defects can be detected. This information is obtained from the analysis of number of deposited layers. Defect 1 and Defect 5 have the same width but they are detected from different height. This is because Defect 1 is the through-fault, whereas Defect 5 is open to surface defect, which formation is started after fabrication of first 2 mm of the part.

Table 2 Detectable defects with their minimal height

Defect	Length (mm)	Width (mm)	Detection height (mm)
1	10	0.5	0.45
2	10	3	0.16
3	10	2	0.16
4	10	1	0.6
5	10	0.5	0.6
6	10	0.2	0.9
7	10	0.1	0.9

In order to obtain the information about the position of defect in the manufactured part and to define its length the cartography of the fused area could be realized with the EC array sensor. This will increase the complexity of electronics and signal interpretation. This solution is not studied as the aim of this work is to demonstrate the feasibility of the EC sensor design for the in-situ monitoring.

## 4 Conclusions

During this study the possibility of in-situ monitoring with eddy current probe fixed on the recoater has been evaluated. The part made from AlSi7Mg has been manufactured with the defects defined in CAD design of the part. Non fused powder used for L-PBF process around the fused area does not have influence to the in-situ monitoring. We did not observe degradation of signal-to-noise ratio.

The study has shown that in-situ monitoring of the part is able to detect defects of the order of 0.1 mm (width). Nevertheless, the height of the defects plays also an important role in detectability. The defects of width of 3mm and 2 mm were detected from heights larger than 0.16 mm whereas thinner defects of 0.5 mm were detected from heights larger than 0.6 mm

A key point to improve the in-situ monitoring by ECT is the development of array sensor with sufficient spatial resolution and with optimised step between the elements in order to cover the surface of the manufactured part without reducing the scan velocity.

## References

1. Wohlers T, Campbell R I; Diegel O, Huff R. Kowen, J, Wohlers report 2020: 3D printing and additive manufacturing state of the industry, Wohlers Associates: Fort Collins, CO, USA, 2020.
2. Singamneni, S.; Lv, Y.; Hewitt, A.; Chalk, R.; Thomas, W.; Jordison, D. (2019) Additive manufacturing for the aircraft industry: A review, J. Aeronaut. Aerospace Eng. 8 (1), 215 <https://doi.org/10.35248/2168-9792.19.8.215>
3. Everton S, Hirsch M, Stravroulakis P, Leach R et Clare A (2016) Review of in-situ process monitoring and in-situ metrology for metal additive manufacturing. Materials & Design, 95 : 431-445. <https://doi.org/10.1016/j.matdes.2016.01.099>
4. Mohr, G.; Altenburg, S.J.; Ulbricht, A.; Heinrich, P.; Baum, D.; Maierhofer, C.; Hilgenberg, K. (2020) In-situ defect detection in laserpowder bed fusion by using thermography and optical tomography—comparison to computed tomography. Metals, 10, 103. <https://doi.org/10.3390/met10010103>
5. Mitchell, J.A.; Ivanoff, T.A.; Dagel, D.; Madison, J.D.; Jared, B. (2020) Linking pyrometry to porosity in additively manufactured metals. Addit. Manuf. 31, 100946. <https://doi.org/10.1016/j.addma.2019.100946>
6. Todorov, E.; Boulware, P.; Gaah, K. (2018) Demonstration of array eddy current technology for real-time monitoring of laser powder bed fusion additive manufacturing process. Proc. SPIE, 10599, 1059913. <https://doi.org/10.1117/12.2297511>
7. Todorov, E.I. Non-destructive Evaluation of Additive Manufacturing Components. U.S. Patent US 2018/0266993 A1, 20 September 2018
8. Spurek, M.A.; Luong, V.H.; Spierings, A.B.; Lany, M.; Santi, G.; Revaz, B.; Wegener, K. (2021) Relative density measurement of PBF-manufactured 316L and AlSi10Mg samples via eddy current testing. Metals , 11, 1376. <https://doi.org/10.3390/met11091376>
9. Ehlers, H.; Pelkner, M.; Thewes, R. (2020) Heterodyne eddy current testing using magnetoresistive sensors for additive manufacturing purposes. IEEE Sens. J., 20,11: 5793-5800. <https://doi.org/10.1109/JSEN.2020.2973547>
10. <https://eddyfi.com>
11. [www.extende.com](http://www.extende.com)

## Statements and declarations

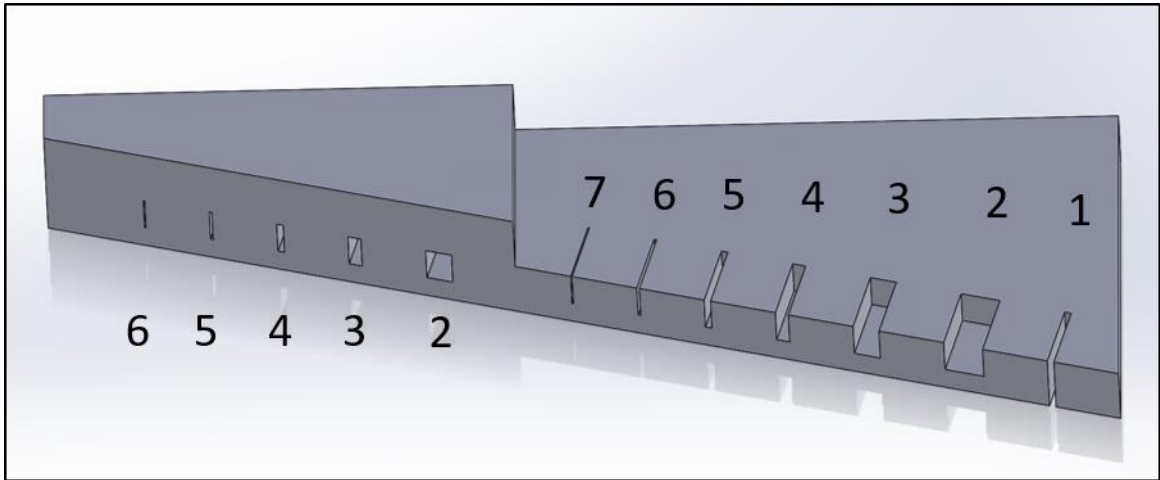
**Author contribution** All authors contributed to the study. N.Sergeeva-Chollet: conceptualization, investigation, methodology, experimentation, analysis. K.Perlin: part design, mechanical support development, experimentation. M.Pellat: conceptualization, experimentation. The first draft was written by N.Sergeeva-Chollet.

**Funding** The current work is funded by CEA

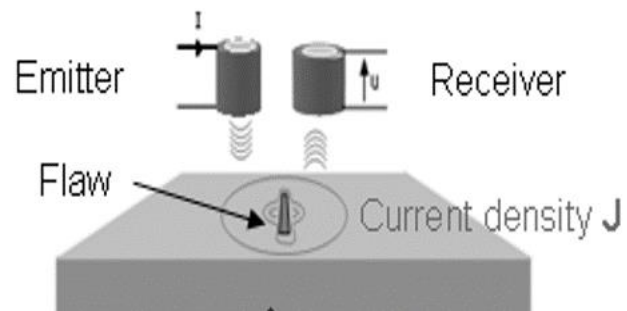
**Conflict of interest** The authors declare no competing interests

## List of figures

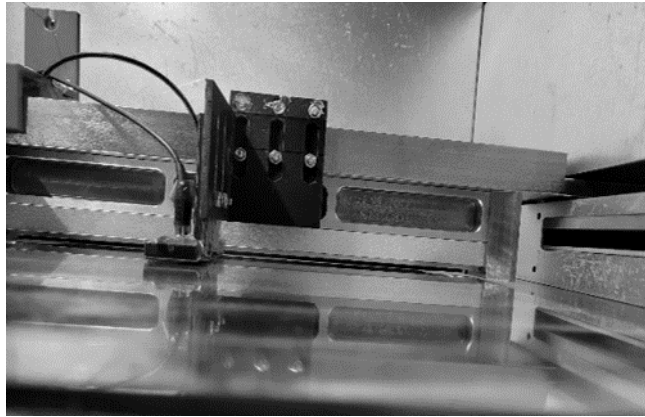
<b>Fig. 1</b> CAD of fabricated part.....	12
<b>Fig. 2</b> Eddy current testing principle .....	13
<b>Fig. 3</b> Mechanical support for EC sensor fixation on recoater of Farsoon machine .....	14
<b>Fig. 4</b> Installation of EC system for in-situ monitoring .....	15
<b>Fig. 5</b> Experimental results obtained with EC sensor, EC signal from built plate and powder feeder .....	16
<b>Fig. 6</b> Experimental results obtained with EC sensor, EC signal from built plate, fused area and powder feeder after 10 layers fusion.....	17
<b>Fig. 7</b> EC signal after 15 powder layers deposition and fusion, detection of defect with the width of 0.5 mm in the part under manufacturing .....	18
<b>Fig. 8</b> EC signal (a) after 72 powder layers deposition and fusion, detection of defects 1, 2 and 3 with the width of 0.5 mm, 3 mm and 2 mm (b) after 87 powder layers deposition and fusion, detection of defects 1, 2, 3, 4 and 5 with the width of 0.5 mm, 3 mm and 2 mm, 1 mm and 0.5 mm (c) after 97 powder layers deposition and fusion, detection of all defects 1, 2, 3, 4, 5, 6 and 7 with the width of 0.5 mm, 3 mm and 2 mm, 1 mm, 0.5 mm, 0.2 mm and 0.1mm in the part under manufacturing. ....	19
<b>Fig. 9</b> EC signal from the part after manufacturing after first step fusion and deposition and fusion of 1 layer of the second step of the part (165 layers). ....	20
<b>Fig. 10</b> EC signal from the part after manufacturing after first step fusion and deposition and fusion of 6 layers of the second step of the part (170 layers). ....	21



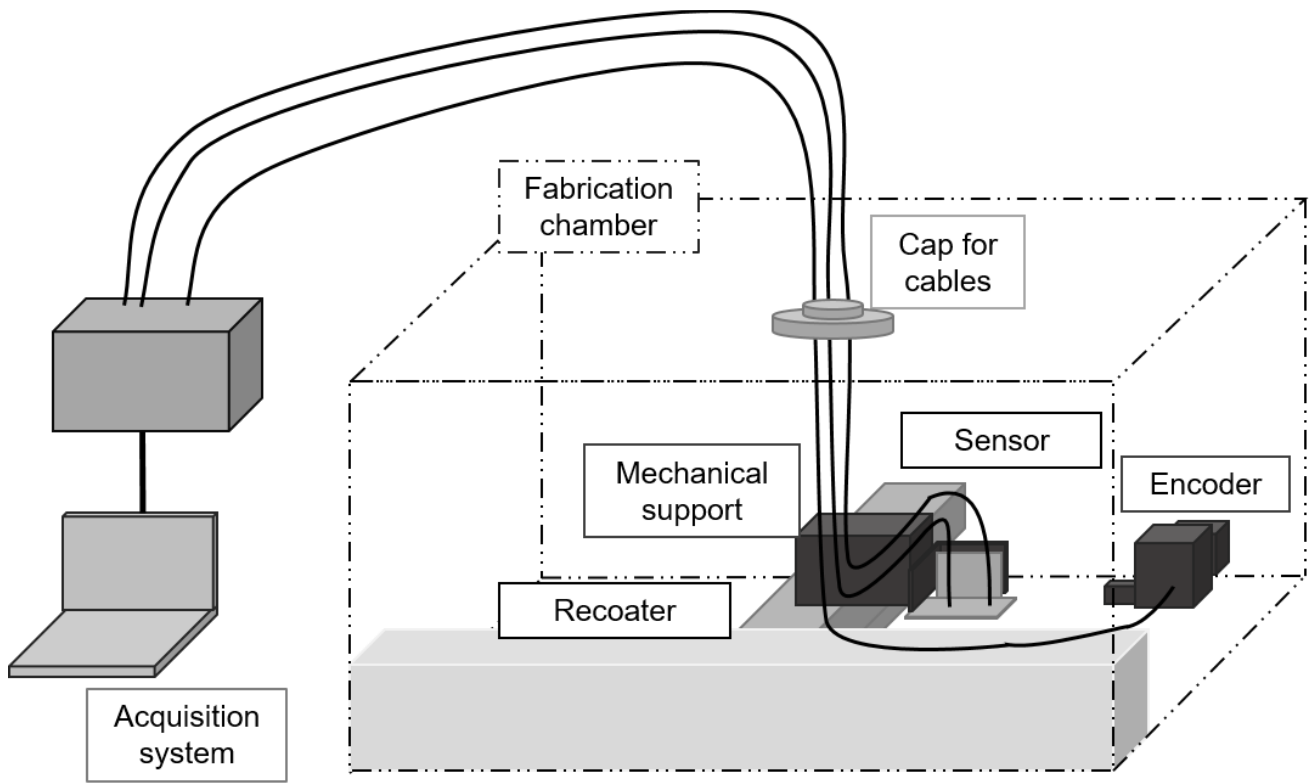
**Fig. 1** CAD of fabricated part



**Fig. 2** Eddy current testing principle

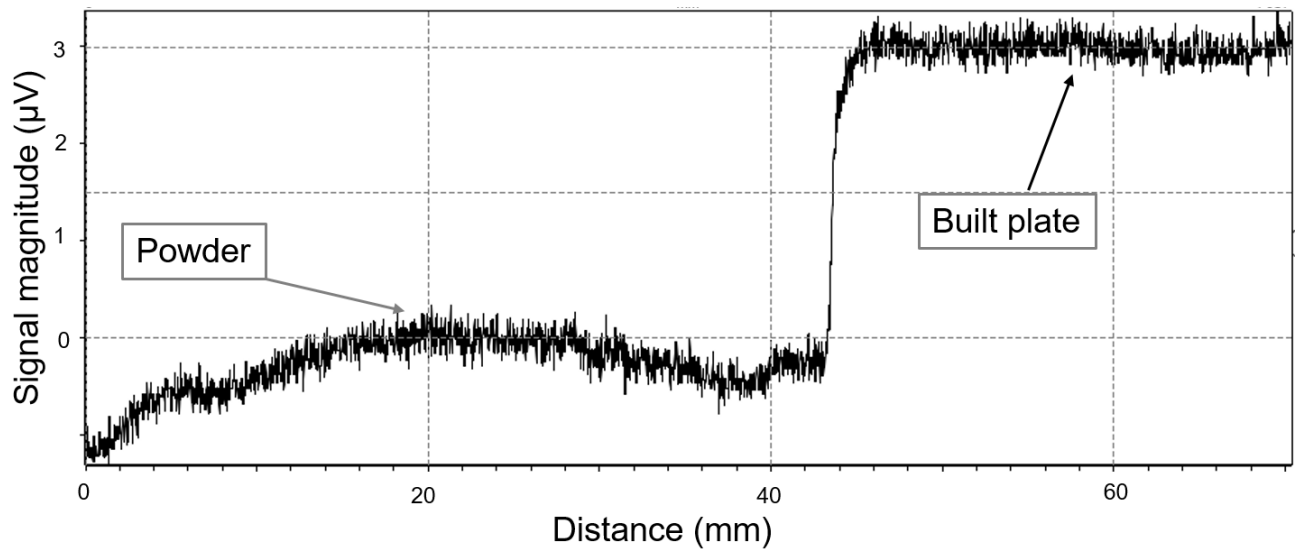


**Fig. 3** Mechanical support for EC sensor fixation on recoater of Farsoon machine

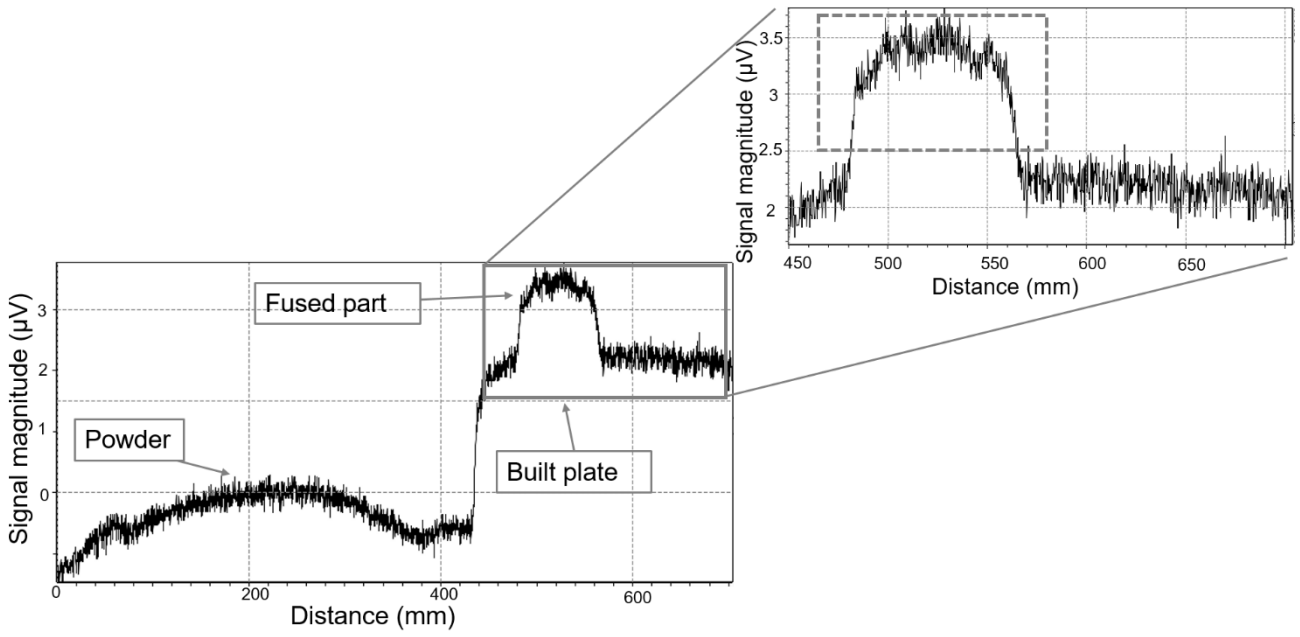


**Fig.4** Installation of EC system for in-situ monitoring

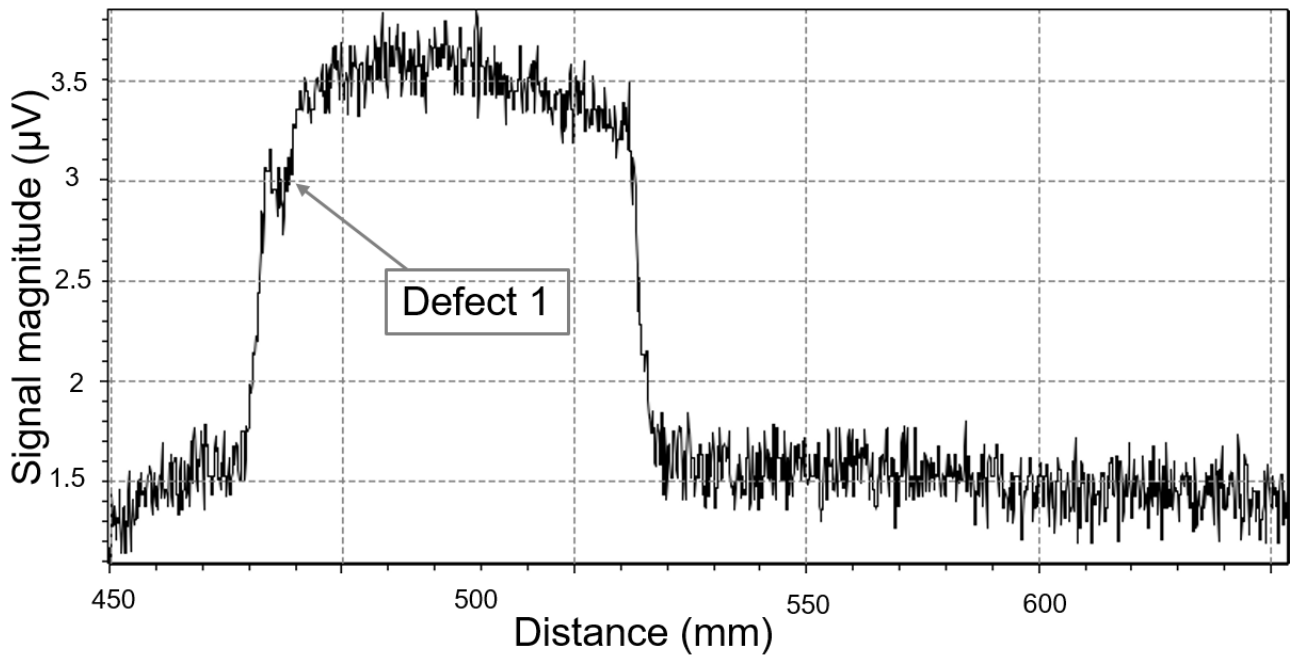




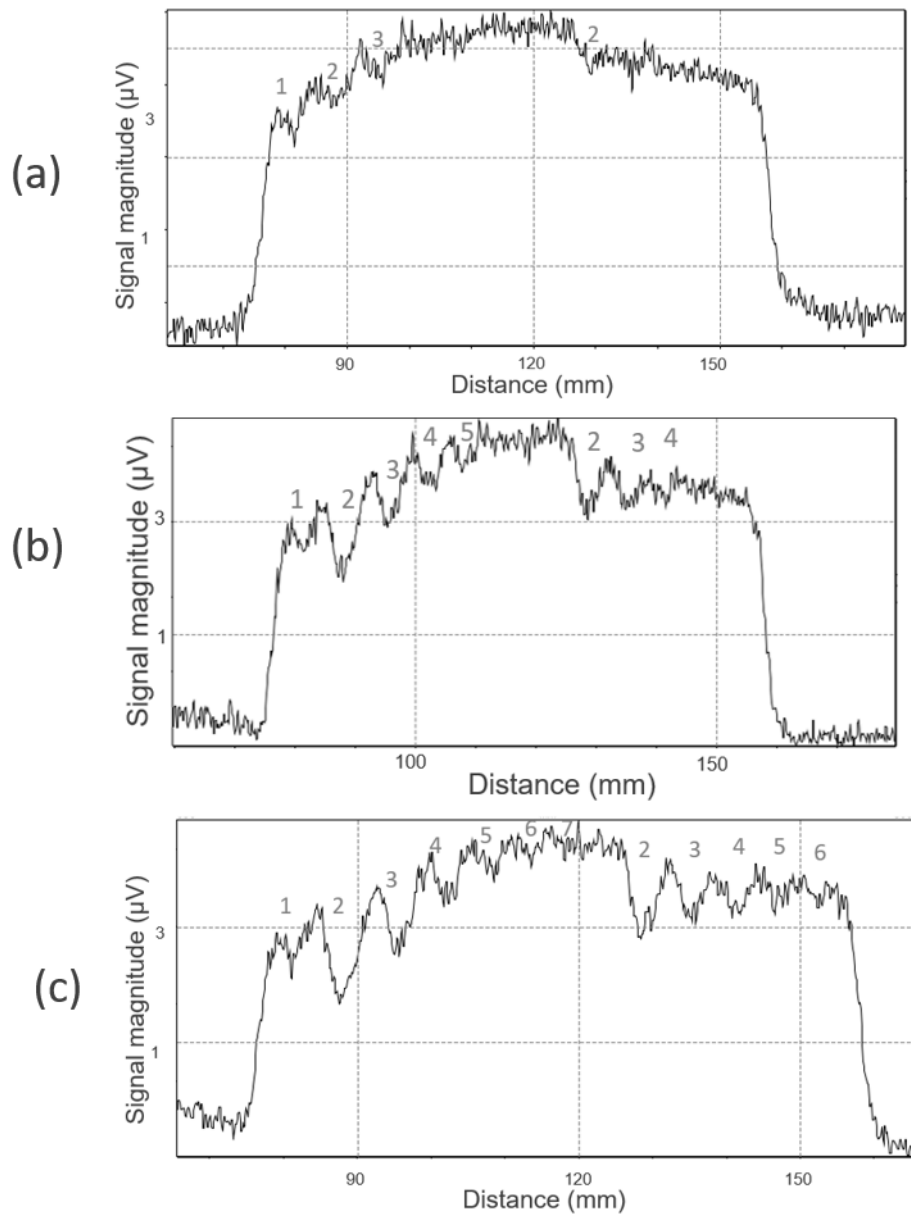
**Fig. 5** Experimental results obtained with EC sensor, EC signal from built plate and powder feeder



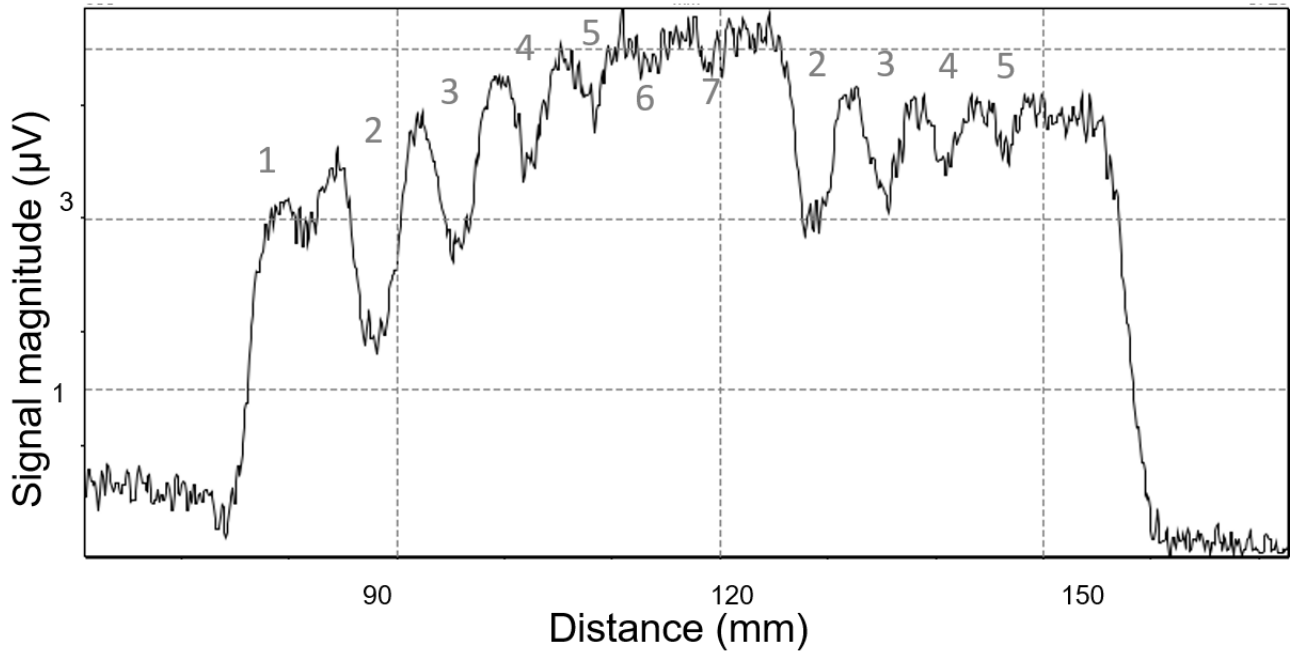
**Fig. 6** Experimental results obtained with EC sensor, EC signal from built plate, fused area and powder feeder after 10 layers fusion



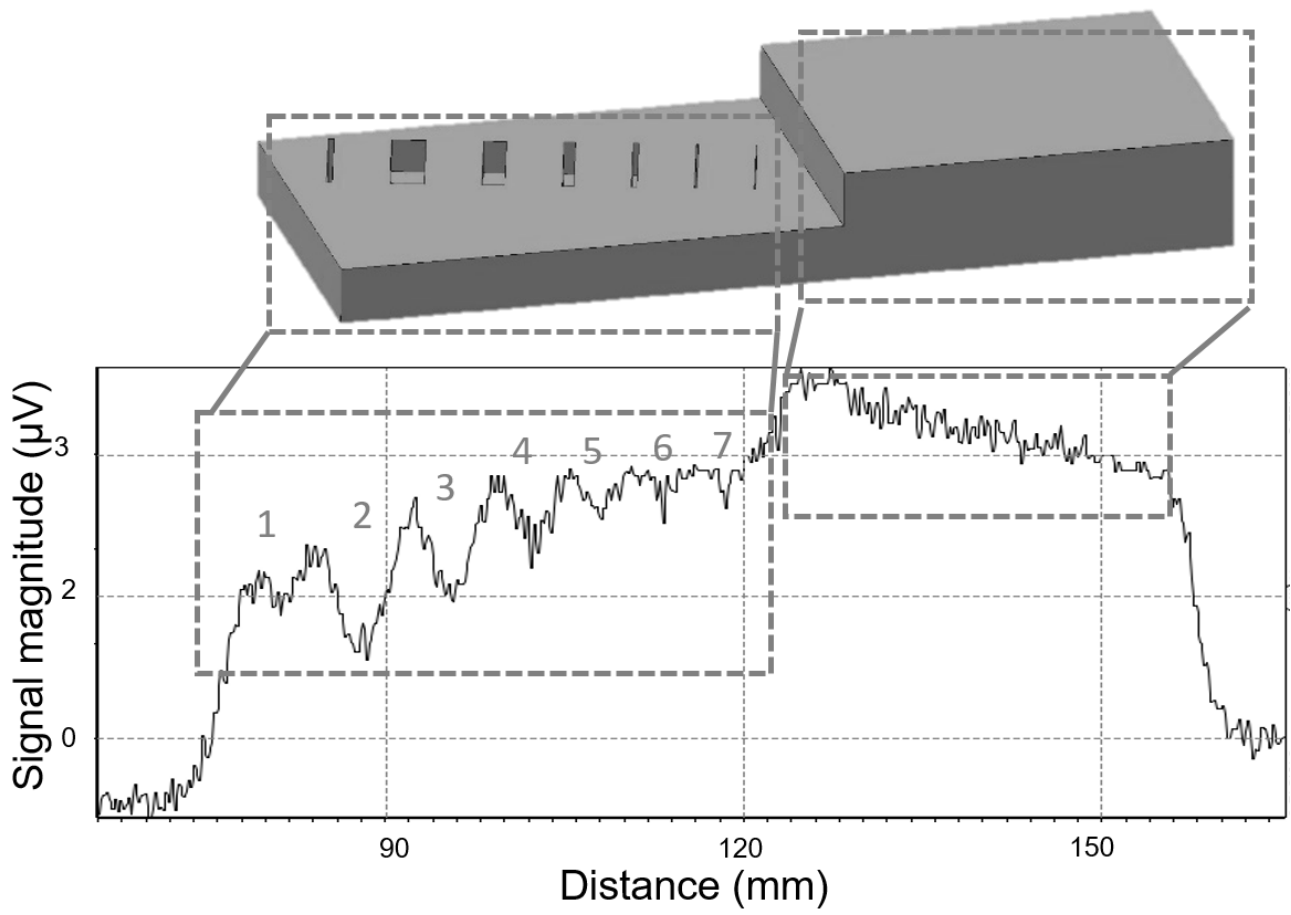
**Fig. 7** EC signal after 15 powder layers deposition and fusion, detection of defect with the width of 0.5 mm in the part under manufacturing



**Fig. 8** EC signal (a) after 72 powder layers deposition and fusion, detection of defects 1, 2 and 3 with the width of 0.5 mm, 3 mm and 2 mm (b) after 87 powder layers deposition and fusion, detection of defects 1, 2, 3, 4 and 5 with the width of 0.5 mm, 3 mm and 2 mm, 1 mm and 0.5 mm (c) after 97 powder layers deposition and fusion, detection of all defects 1, 2, 3, 4, 5, 6 and 7 with the width of 0.5 mm, 3 mm and 2 mm, 1 mm, 0.5 mm, 0.2 mm and 0.1mm in the part under manufacturing.



**Fig. 9** EC signal from the part after manufacturing after first step fusion and deposition and fusion of 1 layer of the second step of the part (165 layers).



**Fig. 10** EC signal from the part after manufacturing after first step fusion and deposition and fusion of 6 layers of the second step of the part (170 layers).