



HAL
open science

Study of the performance and time response of the RadonEye Plus2 continuous radon monitor

Ivelina Dimitrova, Strahil Georgiev, Krasimir Mitev, Vladislav Todorov, Chavdar Dutsov, Benoit Sabot

► **To cite this version:**

Ivelina Dimitrova, Strahil Georgiev, Krasimir Mitev, Vladislav Todorov, Chavdar Dutsov, et al.. Study of the performance and time response of the RadonEye Plus2 continuous radon monitor. *Measurement*, 2023, 207, pp.112409. 10.1016/j.measurement.2022.112409 . cea-03889498

HAL Id: cea-03889498

<https://cea.hal.science/cea-03889498v1>

Submitted on 8 Dec 2022

HAL is a multi-disciplinary open access archive for the deposit and dissemination of scientific research documents, whether they are published or not. The documents may come from teaching and research institutions in France or abroad, or from public or private research centers.

L'archive ouverte pluridisciplinaire **HAL**, est destinée au dépôt et à la diffusion de documents scientifiques de niveau recherche, publiés ou non, émanant des établissements d'enseignement et de recherche français ou étrangers, des laboratoires publics ou privés.



Distributed under a Creative Commons Attribution 4.0 International License



Study of the performance and time response of the RadonEye Plus2 continuous radon monitor

Ivelina Dimitrova^a, Strahil Georgiev^{a,*}, Krasimir Mitev^a, Vladislav Todorov^a,
Chavdar Dutsov^{a,b}, Benoit Sabot^c

^a Sofia University "St Kliment Ohridski", Faculty of Physics, 5 James Bourchier Blvd., Sofia, 1164, Bulgaria

^b Paul Scherrer Institute, Villigen PSI, 5232, Switzerland

^c Université Paris-Saclay, CEA, LIST, Laboratoire National Henri Becquerel (LNE-LNHB), Palaiseau, F-91120, France

ARTICLE INFO

Keywords:

Continuous radon monitors
Radon variations
Response time
RadonEye Plus2 monitor
Indoor radon

ABSTRACT

The availability of affordable continuous radon monitors opens new opportunities for studying the temporal variations of indoor radon and for more precise exposure estimates based on the actual hours spent in homes and workplaces. These new applications require tests of the monitors characteristics, including their response time. A study of a promising electronic radon monitor with high sensitivity, the RadonEye Plus2, was conducted. It was found that it has excellent linearity up to 3500 Bq/m³. A slight deviation from linearity within 12% was observed in the range 3500–7000 Bq/m³. The reproducibility of measurements with 36 different RadonEye monitors was within 7%, estimated in the range of linearity.

A dedicated procedure for time response characterization was developed based on exposure to rectangular activity concentration pulses (spikes). It was applied to the RadonEye and three other commercial monitors. The determined characteristic response times of the RadonEye monitor are about 40 min for reaching 50% of the plateau of a rectangular pulse and 90 min for reaching 90%. They are somewhat higher than the corresponding response times of the AlphaE monitor, which are 20 and 60 min, respectively. The response times of the RAD7 monitor in sniff mode are about 3 min for reaching 50% of the plateau and 10 min for reaching 90%. The AlphaGUARD monitor in flow-through mode has the fastest response — it reaches 95% of the plateau in less than 2 min. The monitor AlphaGUARD PQ2000 Pro Rn/Tn is therefore recommended for follow-up of the activity concentration in time response studies of other monitors. It is demonstrated that by exposure to spikes the response function of a monitor can be obtained and used to model its response to variable concentrations.

Overall, the RadonEye's response is sufficiently fast to follow radon variations even in buildings with active ventilation. This sensitive monitor is suitable for homes and workplaces and can be helpful in the installation and investigation of radon mitigation systems and in studies of the indoor radon dynamics.

1. Introduction

Since indoor radon exposure is the leading cause for lung cancer in non-smokers [1], radon concentration is among the most important indoor air quality factors. In the last years, various affordable radon monitors were developed, which makes possible the continuous follow up of radon in homes and workplaces. This opens new opportunities for studying the dynamics of indoor radon and for more precise estimates of the radon exposure based on the actual hours spent in a building.

A serious challenge is the estimation of the exposure in workplaces with part-time operation. These workplaces might have passive or active ventilation systems that often reduce the concentration of radon while the building is in use [2]. In such buildings it is typical for radon

concentration to drop rapidly when the ventilation is switched on and to grow fast when the ventilation is switched off [2,3] and the changes could be 2–3 orders of magnitude. The time needed for such changes is of the order of tens of minutes [2–4]. There are also cases in which the radon concentration during working hours is higher than the average radon concentration [5]. Therefore, the long-term measurements by passive detectors in workplaces could bias the estimate of the workers radon exposure. The problem could be addressed by continuous measurements by active monitors as long as their time-response is fast enough to follow the changes in the concentration.

In addition, continuous radon monitors could advance studies on the temporal variations of indoor radon. They could offer more insight

* Corresponding author.

E-mail address: strahilg@phys.uni-sofia.bg (S. Georgiev).

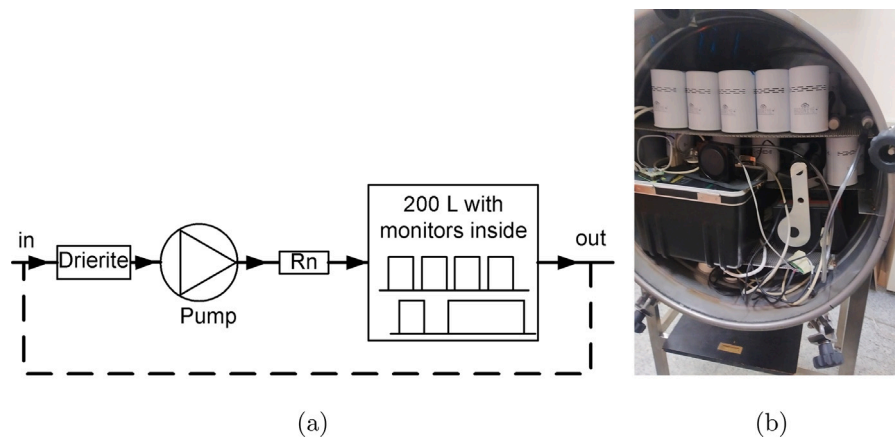

Fig. 1. (a) Scheme of the exposure system used for the study of the linearity and reproducibility of the RadonEyes. (b) A picture of the monitors arranged in the 200 L vessel.

on the applicability of seasonal correction factors to estimates of the annual average radon concentration based on measurements with a shorter duration. This is an important question, since the typical duration of radon measurements is three to six months [4,6]. It rarely reaches an year, which is considered a long waiting time for the occupants to discover whether they are at high risk. Continuous radon monitors could further facilitate studies on the correlation between indoor radon concentration and environmental factors. Such studies have up to now been conducted by passive radon detectors [7,8] that average the concentration over several months or in a limited number of buildings [9] due to the high cost of continuous radon monitors.

Furthermore, sensitive continuous monitors could be useful in buildings that have undergone or are in the process of undergoing radon mitigation. They can assess the effect of passive measures or follow the performance of active anti-radon installations. The potential for widespread use of electronic radon monitors is also enhanced by their ability to communicate with smart devices. In the future, this could be used to actually improve the indoor air quality by controlling ventilation or radon mitigation systems.

The above applications of the continuous radon monitors require dedicated studies of their characteristics. In addition to the tests common for radon detectors, studies on the time response of the monitors should be included. The time response is crucial for deriving information from the signal dynamics and for estimation of the exposure in given intervals. The current work is a study of the RadonEye Plus2 electronic radon monitor [10]. Along with the monitor's linearity and measurement reproducibility, its time response was studied by a newly developed methodology. The methodology is presented and the time response characteristics of RadonEye Plus2 are compared to these of three other commonly used commercial monitors.

2. Materials and methods

The RadonEye Plus2 [10] is a small radon detector based on a pulsed ionization chamber. It can connect to smart phones via WiFi and report radon measurements every 10 min. The reported value is a running average of the last 60 min [10] and does not include uncertainty. Its measurement range is from 7 to 9435 Bq/m³ and its sensitivity is 0.5 cpm/pCi/L (0.014cpm/Bq/m³) as provided by the producer [10]. The detector is sensitive to all the alpha particles emitted by radon and its progeny [11]. The high sensitivity and affordable price of the RadonEye Plus2 makes it very appropriate for indoor measurement campaigns. The declared accuracy and reproducibility of RadonEye Plus2 are both <10%. A study of the influence of thoron (²²⁰Rn with half-life of 55.8(3) s [12]) on radon monitors has shown that RadonEye Plus2 is sensitive to thoron [13,14]. Although, this may be a drawback in rare cases in which thoron is present in the environment, it indicates that

the diffusion of radon gas inside the detector's chamber is relatively fast. The fast diffusion is a prerequisite for a fast response time of the monitor.

Thirty six RadonEye Plus2 monitors (or in short RadonEye(s)) were exposed to different activity concentrations of radon. During the exposures the commercial radon monitor AlphaGUARD PQ2000 Pro Rn/Tn [15] was used as a reference monitor. For the time response studies a dedicated detector system with a very fast response, the PIPS system presented in Section 2.3, was used to follow the radon concentration. The time response of RadonEye is compared to that of the AlphaGUARD, RAD7 [16] and AlphaE [17] monitors.

2.1. Study of the linearity and reproducibility

The RadonEyes were exposed in several sessions to different radon concentrations in the range from 150 Bq/m³ to 7000 Bq/m³. The exposures were carried out in a 200 L radon chamber with the setup shown in Fig. 1. This setup allows control of the activity concentration inside the chamber by connecting the system in open-loop and adjusting the flow-rate of air through the source by the pump flow-rate [18].

The AlphaGUARD and the RAD7 monitors were exposed together with the RadonEyes. They were set to report values every 10 min like the RadonEyes. The exposure at each activity continued for at least 12 h (up to 2–3 days for the lower values). The series of measurements at a given activity concentration were used to estimate the average and the standard deviation for each monitor.

The average values for each RadonEye were plotted versus the values estimated by the AlphaGUARD and the RAD7 monitors. The plots were used to study the linearity of the RadonEyes' response in the range 150–7000 Bq/m³. The AlphaGUARD and RAD7 have a much higher upper limit [15,16] and are known to be linear in this range. In Section 3 it is demonstrated that the RadonEye monitors have some non-linearity in the studied range, but linearity can be assumed up to 3500 Bq/m³.

For the range in which linearity of the RadonEyes can be assumed a correction factor to the reference monitor was estimated for each RadonEye. The correction factor R was defined as:

$$R_i = C_{A,ref} / C_{A,i}, \quad (1)$$

where $C_{A,ref}$ is the activity concentration by the reference monitor and $C_{A,i}$ is the one by the i th studied RadonEye. The standard deviation of the values of R for the 36 RadonEyes was used to estimate the reproducibility.

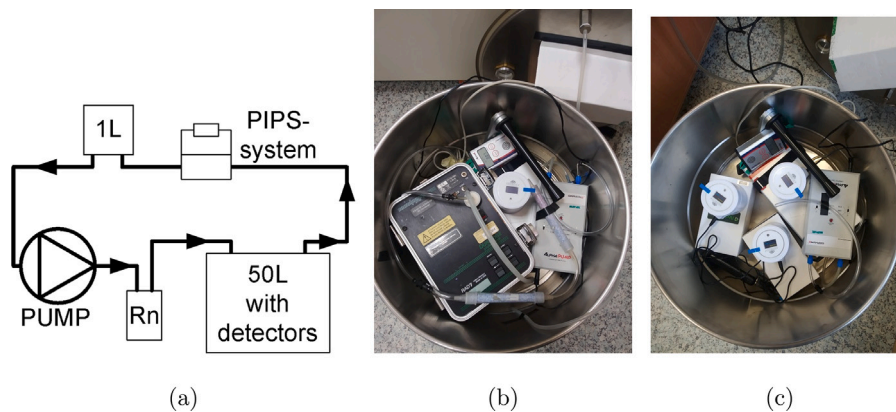

Fig. 2. (a) Scheme of the exposure system used for the time-response study. The photos show the arrangement of the detectors during the exposure at (b) high and (c) low activity concentration.

2.2. Study of the time-response

The studies of the time response of radon monitors require an exposure system in which rapid changes of the radon activity concentration with a characteristic time of a minute or less can be created. It is also necessary to follow the activity inside the system with a reference measurement system with a fast response. In order to satisfy the first condition, we used a smaller exposure chamber with a volume of 50 l (the standard exposure chamber of the AlphaGUARD set). The activity needed for the exposure was prepared in a small volume drexel (about 180 ml). The exposure setup used in this study is shown in Fig. 2. It was a closed-loop system with a pump that provides 2 l/min airflow in the system. At the end of the exposure, the system is opened to quickly flush radon.

To follow the activity concentration a system with a very fast response — the “PIPS-system” developed at Laboratoire National Henri Becquerel (CEA/LNHB) was used. However, it is not sensitive enough to make fast measurements of concentrations of a few kBq/m³, i.e. in the range in which RadonEyes operate. That is why, the PIPs-system was used to test whether the activity in the exposure system can be changed quickly and to study the response of the monitors AlphaGUARD, RAD7 and AlphaE. Since the AlphaGUARD proved to have a fast response, it was further used to follow the activity changes in the system at activity concentrations in the range for which RadonEye response is linear (below 3500 Bq/m³).

The study involved two different exposure sessions at two different ranges of activity concentrations:

- First session with activity concentrations reaching 300–400 kBq/m³ followed by the PIPs-system. The monitors AlphaGuard, RAD7 and AlphaE were exposed and their time response was studied (Fig. 2(b)). The monitors were placed in the exposure chamber and the PIPs-system was connected to the outlet of the exposure chamber. In this range one short spike (16 min duration) and three long spikes (1 h duration) were created. The single-measurement durations of each detector in these four experiments are presented in Table 1.
- Second session with activity concentrations reaching 2.5–3 kBq/m³ followed by the AlphaGUARD monitor (Fig. 2(c)). The time response of the RadonEyes was studied. In this range one short spike (20 min duration), two long spikes (1 h and 3 h duration) and one step-like changing concentration (3 steps, 1.5 h each) were created.

The response of the monitors that allow active sampling (the PIPs-system, AlphaGUARD and RAD7) was studied in flow-through mode and the response of the rest (AlphaE and RadonEye) in diffusion mode. The RAD7 was used in sniff mode, in which it analyzes only the

Table 1

Duration of the consecutive single measurements of the continuous monitors in the study of their response time at high radon concentration. Flow-through sampling by pump was used for all except the AlphaE, for which only diffusion sampling is possible.

	Short spike	Long spike, 1 h duration		
	15 min duration	No 1	No 2	No 3
PIPS-system	1 min	2 min	2 min	2 min
AlphaGUARD	1 min	1 min	1 min	10 min
RAD7 (sniff mode)	2 min	5 min	5 min	5 min
AlphaE	5 min	5 min	5 min	5 min

peak of ²¹⁸Po and has a faster response time. The in-built fan of the chamber was switched-on in all exposures. This fan faces directly the exposure volume and could speed up radon entry in the volume of the passive-sampling monitors. Therefore, it was screened by a cardboard which redirected the initial airflow of the fan towards the walls of the exposure chamber. Because of the small volume of the chamber, only 3 RadonEyes were used in this study.

2.3. The PIPS-system

For the time response studies the “PIPS-system” was used [19–21]. It is a modified version of the French reference thoron detector, developed at Laboratoire National Henri Becquerel (CEA/LNHB) and has a very fast response, which makes it suitable for observing rapid activity changes.

The PIPs-system is schematically shown in Fig. 3(a). An external pump ensures the flow of the measured air through the lower chamber of the PIPs-system. The lower and the upper chamber are separated by a metallic mesh and two mixed cellulose ester membrane filters with pore size of 0.3 μm and total thickness of about 300 μm. The filters stop the radon and thoron progeny and let both radon and thoron diffuse freely from the lower in the upper chamber [22]. When radon and/or thoron decay their progenies are collected at the surface of the PIPs detector by the electrostatic field between the detector’s surface and the metalized walls of the upper chamber and the metallic mesh. The PIPs-detector registers the alpha-particles and its signal is further processed by a nanoMCA (a combined real-time digital pulse processor and a digital multichannel analyzer by [23]). An example of the alpha-particles energy spectrum of radon and its progeny obtained with this system is shown in Fig. 3(b). The radon progeny, deposited on the PIPs-detector surface form discrete peaks, while the alpha-particles of radon (homogeneously spread in the upper chamber) form a continuum.

Up to now the PIPs-system was calibrated for radon measurements by the alpha-particles of the radon progeny [21], which limits the time-response of the system to a typical time of 10–15 min determined by

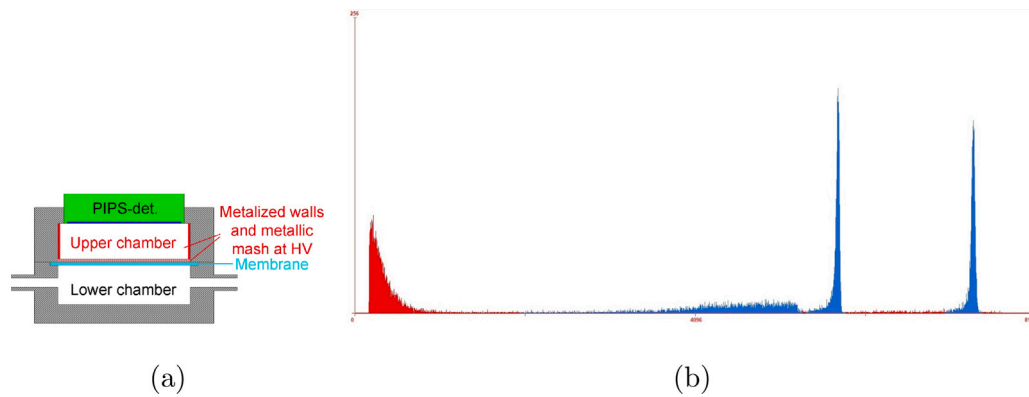

Fig. 3. (a) Scheme of the PIPS-system. (b) An alpha-spectrum of ^{222}Rn (the marked continuum) and its short-lived progeny ^{218}Po (the left peak) and ^{214}Po (the right peak) acquired with the PIPS-system. The regions of interest (ROIs) are marked in blue.

the build-up of ^{218}Po (half-life of 3.094(6) min [24]). For the purposes of the present study, the PIPS-system was calibrated for radon measurements by the alpha-particles of radon – i.e. the radon continuum in the alpha-particle spectrum Fig. 3(b). To estimate the efficiency of the PIPS-system data from a previous study [21] was used. The estimated efficiency for the alpha-particles of radon was $\epsilon = 0.329(17)$. This efficiency is in very good agreement with the radon measurement efficiency $\epsilon = 0.320(2)$ of the French reference thoron detector, as it is also calibrated for radon measurements, performed in the same way by [20].

3. Results and discussion

3.1. Linearity and reproducibility of the RadonEyes

The values measured by the AlphaGUARD/RAD7 were plotted versus the values measured by each of the RadonEyes (see the example in Fig. 4). Linear fitting of the data was carried out and the r-squared and chi-squared values of the fits were estimated. In the estimate of the chi-squared value only the uncertainties of the AlphaGUARD or RAD7 measurements were included. They were estimated by propagation of the uncertainties of the series of 10-min measurements. The uncertainties of the RadonEyes values were much smaller, since they only included the standard deviation of the series of measurements.

For all RadonEyes excellent correlations with r-squared values above 0.98 were observed with the values estimated by the AlphaGUARD and RAD7 for the range below 3500 Bq/m^3 (as measured by the reference monitor). The fits passed through the origin within the uncertainty. The correlation was still very good when the whole range of activities (150–7000 Bq/m^3) was included, but a trend of the RadonEyes to underestimate the higher values became visible and all linear fits passed below the origin (see Fig. 5). The linear fits in the whole range were characterized with much higher chi-squared values and lower p-values (the probability not to reject the fit) than those for the range below 3500 Bq/m^3 . This tendency for non-linearity was observed for all studied RadonEyes with respect to both the AlphaGUARD and the RAD7. Non-linearity in the signal of RadonEye Plus2 monitors has already been noted by [5]. A possible reason for the non-linearity is deadtime in the signal processing of the RadonEye monitors, although no data on it is provided by the producer.

For each RadonEye monitor the correction factor R_0 to the reference monitor AlphaGUARD, defined by Eq. (1) in the region below 3500 Bq/m^3 , was estimated by the angular coefficient of the linear fit (see Fig. 4). The values of R_0 for each of the 36 studied RadonEye monitors are shown in Fig. 6. It can be seen that most of the studied RadonEyes overestimate the radon activity concentration, since a higher R corresponds to a lower reported value C_A . For 23 of the 36 studied RadonEyes the value of R_0 differs from 1 by more

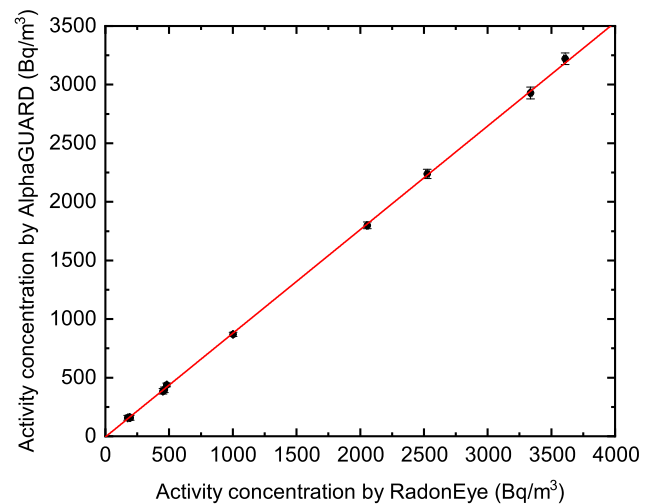

Fig. 4. Radon activity concentration measured by the AlphaGUARD and one of the RadonEye monitors in the exposures below 3500 Bq/m^3 . The line marks linear fit of the data with angular coefficient $a = 0.8841(51)$ and free parameter $b = -5.7(56)$. The r-squared value of the fit is 0.9998 and the p-value of the chi-squared test is 0.9615.

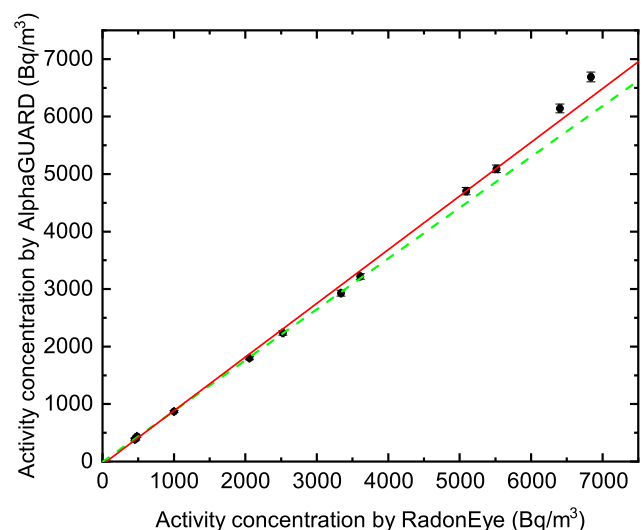

Fig. 5. Radon activity concentration measured by the AlphaGUARD and one of the RadonEye monitors in all conducted exposures. The solid line marks linear fit of the data with angular coefficient $a = 0.9333(14)$ and free parameter $b = -50(27)$. The r-squared value of the fit is 0.9963 and the p-value of the chi-squared test is $5.92 \cdot 10^{-8}$. The dashed line marks the fit for the data below 3500 Bq/m^3 , shown in Fig. 4.

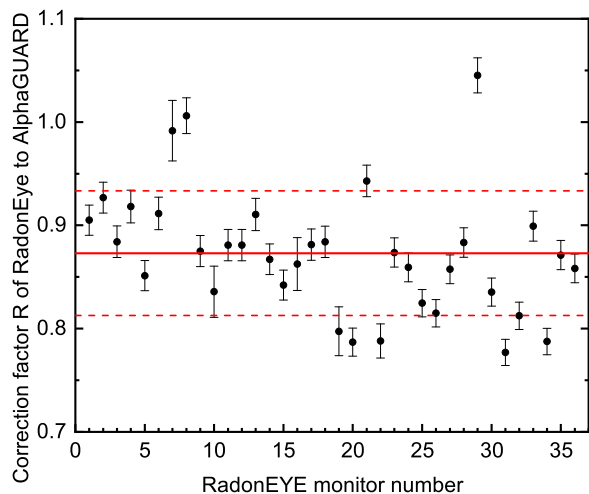

Fig. 6. Correction factor R for all studied RadonEyes to the referent activity by the AlphaGUARD in the range below 3500 Bq/m³. The error bars are at the level of 1σ . The solid line marks the average and the dashed lines the borders of the 1σ interval.

than 10% (the accuracy declared by the producer). Therefore, when radon measurements with uncertainty less than 20% are required, the RadonEye should be individually calibrated. The average value of the correction factor R_0 with respect to the AlphaGUARD monitor is 0.873 with a standard deviation of 0.060 (6.9%). The standard deviation was used as an estimate of the reproducibility of RadonEye measurements.

In order to describe the non-linearity, the ratio R was estimated for each RadonEye at each different exposure activity. The value of R was plotted versus the activity concentration $C_{A,ref}$ estimated by the reference monitor (see Fig. 7). Fits with two empirical functions were attempted: quadratic function $f_1(C_{A,ref}) = aC_{A,ref}^2 + b$ and exponential function $f_2(C_{A,ref}) = b \exp(dC_{A,ref})$, where a , b and d are free parameters and b should be close to R_0 . For almost all monitors the fits with the quadratic function had lower chi-squared value than the fits with the exponential function. The fits of $R(C_{A,ref})$ allow to estimate the referent value based on the value reported by the detector in the range of non-linearity. Using the fits for all RadonEyes the ratio $\frac{R_0}{R}$ at 7000 Bq/m³ was estimated at 0.88(16), where the uncertainty accounts for the standard deviation in the batch of studied detectors. It follows that after the individual correction factors R_0 are applied to the values reported by the RadonEyes at 7000 Bq/m³, the activity concentration would on average be underestimated by 12%. However, for a non-calibrated RadonEye the value of R_0 is unknown and the bias for a reported value of 7000 Bq/m³ could be higher.

Overall, the RadonEye monitors proved excellent linearity in the range below 3500 Bq/m³ in which radon concentrations in the majority of buildings lie. For a RadonEye monitor that is not individually calibrated it is recommended to expand the calibration uncertainty (10% declared by the producer) by additional 7% to account for the reproducibility.

3.2. Response time

The radon activity concentrations measured by the detectors in two of the four exposures at high activity concentrations are shown in Fig. 8. Results, similar to these in Fig. 8(b) were obtained from the other two one-hour spikes at high activity concentration (not shown).

The results from the direct radon measurements of the PIPS-system (by the continuum of ²²²Rn) show that rectangular activity pulses (spikes) are successfully created in the exposure chamber. The transient time to reach 100% of the activity concentration at the beginning and to lower the activity concentration down to “zero” at the end of the exposure is about 1–2 min. This is fast enough to study the monitors’

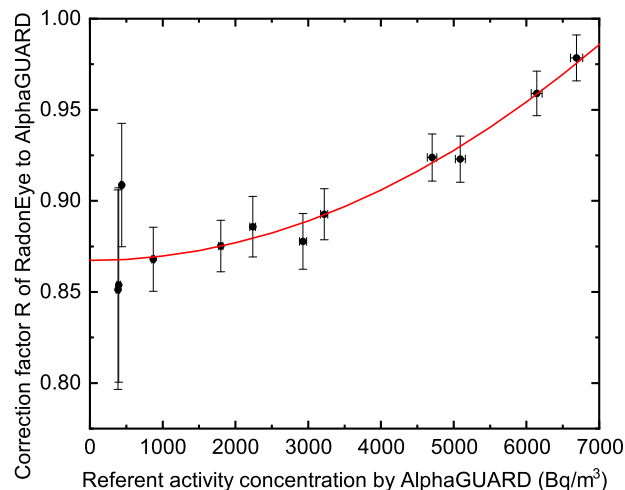

Fig. 7. Correction factor R for one of the RadonEye monitors as a function of the referent activity concentration measured by the AlphaGUARD. The solid line marks fit of the data with the function $f_1 = ax^2 + b$ with $a = 2.42(15) \cdot 10^{-9}$ and $b = 0.8673(38)$. The p -value of the chi-squared test is 0.989.

Table 2

Response times of the studied monitors. T_{50} , T_{90} and T_{95} are the characteristic times in which the signal reaches respectively 50%, 90% and 95%, of the equilibrium value after a step-like increase from zero. The same times apply to a step-like decrease to zero. Where applicable the monitor’s settings are given in brackets.

Monitor	T_{50} , [min]	T_{90} , [min]	T_{95} , [min]
PIPS-system (²²² Rn-continuum)	Reference, $T_{95} \ll 1$ min		
AlphaGUARD (1 min. flow-through)	–	–	1–2
PIPS-system (²¹⁸ Po-peak)	3	10	15
RAD7 (sniff mode)	3	10	15
AlphaE (5 min.)	20	60	80
RadonEye	40	90	120

response. Additionally, this allows to create very short spikes that are suitable to study the response-function of the monitors (see the next section). The response time of the studied monitors is quantified in terms of the characteristic times T_{50} , T_{90} and T_{95} for the monitor’s signal to reach respectively 50%, 90% and 95% of its equilibrium activity after a step-like increase from zero. The results show that the characteristic times for decrease of the signal to zero are similar. The characteristic response times of the studied detectors are given in Table 2. In the case of the AlphaGUARD the response time is obtained empirically due to its fast response. For all other monitors the characteristic times are obtained both empirically and by exponential fitting of the detectors’ data and the two approaches give similar values.

The experimental results show that the response time of the AlphaGUARD is about 1–2 min — its readings seem to be coherent after the first 1 or 2 one-minute measurements (see Fig. 8). This proves that the AlphaGUARD is suitable for the follow up of such fast changes, including rectangular activity pulses. It should be noted that for monitors with active sampling, their response time is influenced by the “refresh” time τ_r of the active volume of the monitor. This is the characteristic time for reaching equilibrium between the activity concentration C_{in} in the monitor’s active volume and the ambient activity concentration C_{out} : $C_{in} = C_{out} \exp(-t/\tau_r)$. The refresh time could be estimated as:

$$\tau_r = V/Q, \quad (2)$$

where Q is the air flow-rate through the active volume V . For the AlphaGUARD ($V = 0.56$ l and $Q = 1$ l/min) this time is $\tau_r = 0.56$ min.

It was also observed that when the AlphaGUARD makes 1-min measurements it overestimates the activity concentration in the first few measurements (see Fig. 8(b)). This was also observed in the second one-hour spike when it was running in 1-min mode, but not in the

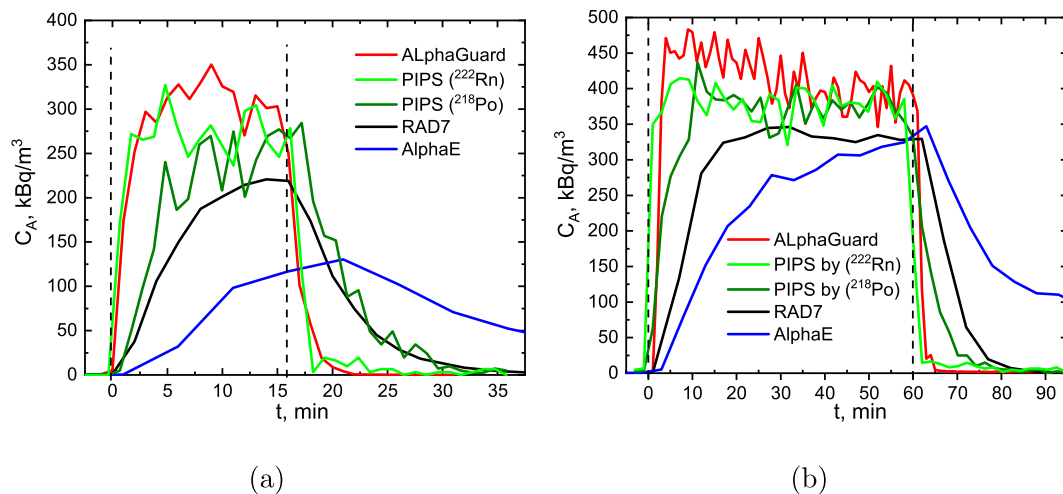

Fig. 8. Monitors' measurements during (a) the 16-min exposure and (b) the first 1-h exposure at high radon concentration. The vertical dashed lines mark the beginning and the end of the exposure (the spike).

third one-hour spike when the AlphaGUARD was running in 10-min mode. Thus, one should analyze the immediate 1-min AlphaGUARD measurements with care.

To measure radon, the RAD7 monitor performs alpha-spectrometric measurements of the short-lived progeny of radon. For faster response it analyzes only the signal from ^{218}Po (sniff mode). Therefore, the response time of RAD7 is limited by the build-up of ^{218}Po in its active volume, when the activity concentration rises and by the decay of ^{218}Po , when the activity goes down. The half-life of ^{218}Po is 3.094(6) min [24] and the refresh time of the RAD7 chamber is $\tau_r = 0.75$ min ($V = 0.75$ l and $Q = 1$ l/min), so the typical response time of RAD7 is expected to be 10–15 min. This expectation is confirmed by the analysis of the results shown in Fig. 8. It is also seen in Fig. 8 that the measurements made by the PIPS-system have similar behavior when the ^{218}Po peak is used for analysis.

The AlphaE monitor is sensitive to all alpha-particles of radon and its progeny, which determines its complex and relatively slow (compared to the AlphaGUARD and RAD7) response. In Fig. 8(b) it is seen that in both cases (activity grow-up and drop-down) there are two components in the response of AlphaE: a fast component, which is due to the alpha-particles of ^{222}Rn and ^{218}Po , and a slow component — due to ^{214}Po . This causes bias in the AlphaE initial measurements that fades with time. It fades fully for about 3 h — the time needed for radon and its short-lived progeny to reach equilibrium. However, due to the fast component, the signal reaches 50% of the equilibrium concentration in 20 min and 90% — in 60 min. Practically the same response times are observed when the activity concentration goes down. This time-response is sufficient for monitoring the radon variations even in buildings with part-time operation and active ventilation. However, due to its low sensitivity of 3 cph at 100 Bq/m^3 [17], the AlphaE is not very suitable for follow-up of the dynamics of indoor radon.

The results from the low activity concentration spikes are shown in Fig. 9. In these exposures the AlphaGUARD is used as a reference monitor. The 1-min measurements of the AlphaGUARD (Figs. 9(a) and 9(b)) confirm that the rectangular spikes are successfully created. Due to the poor counting statistics of the AlphaE, its measurements are only demonstrated in Fig. 9(c) and are not included in the further analysis.

According to its producer, the RadonEye is sensitive to all the alpha-particles of radon and its short-lived progeny [11]. Therefore, similarly to the AlphaE, the RadonEye has a response with a fast and a slow component, clearly seen in Fig. 9(c). The observed timing of the RadonEye response is also similar to that of the AlphaE: when the activity rises, it takes about 3 h to reach equilibrium between radon and its short-lived progeny and to measure radon correctly. It takes 40 min to reach 50%

of the equilibrium activity concentration and about 90 min to reach 90%. Very close response times were observed at decreasing activity concentration. These values are in agreement with the values reported by [5], who observed that an hour after injection of radon activity, the RadonEye recorded $(79 \pm 3)\%$ of the true radon concentration and after two hours $(96 \pm 4)\%$. The results show that RadonEye monitors could be successfully used for monitoring of the diurnal radon variations even in workplaces with part-time operation. The time response is also sufficiently fast to follow the variations of radon associated with changes in the environmental conditions. Notably, the RadonEyes have a slightly longer response time compared to AlphaE, which could be explained by the in-built smoothing algorithms of the RadonEye: it is stated that the values reported by the device are a 1-h moving average [11]. This online measurement processing could explain two more things that are seen in Fig. 9: 1. The measurements are smoothed near the points of rapid drop of activity and 2. The reaction of the RadonEyes is shifted (delayed) by 10 min.

3.3. Study of the response function

For detectors with relatively slow response time, it is worth to study their response function F_R . The activity concentration measured by the monitors C_m is, in fact, a convolution of the response function F_R and the real activity concentration C_r :

$$C_m = F_R * C_r = \int_{-\infty}^{\infty} F_R(\tau) C_r(t - \tau) d\tau, \quad (3)$$

where t and τ are time variables. The knowledge of the response function could facilitate the analysis of the measurements and the assessment of the time-limits of the monitor. Moreover, the response function could be used to deconvolute the signal $C_m(t)$ and restore the real activity concentration $C_r(t)$.

The response function of a radon monitor could be obtained by exposing it to a short pulse of radon concentration. The pulse duration should be: 1. Shorter than the typical time of the radon variations to be studied and 2. Comparable to the single measurement duration of the detector. In this sense, the short spikes (with duration 15–20 min) described in the previous section are very suitable for such study. On the other hand, the RadonEye and the AlphaE monitors could perform consecutive measurements with a single measurement duration much shorter than their response time, which ensures a detailed follow up of their response. This makes these two monitors very suitable to study the feasibility of such an approach: 1. To obtain the response function of the detector by a short spike and 2. Use it to model the response of the detector. To study this approach, the experiments described above were used:

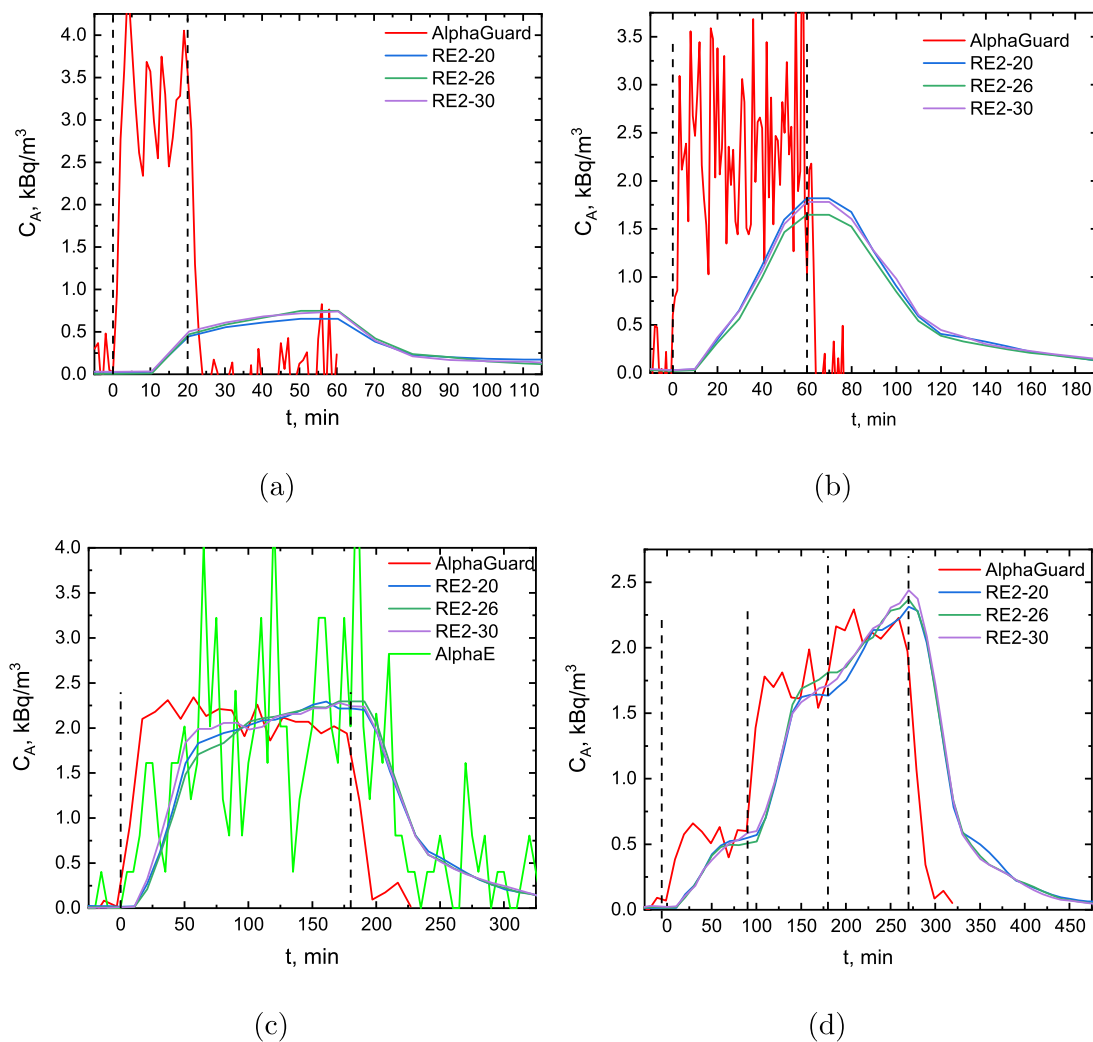

Fig. 9. RadonEyes and AlphaGUARD measurements during (a) the 20-min exposure, (b) the 1-h exposure, (c) the 3-h exposure and (d) the 3×1.5 h exposure at lower radon concentration. The vertical dashed lines mark the beginning and the end of the exposure and the changes in the activity concentration in the 3×1.5 h exposure.

1. The response functions F_R of the RadonEyes (see Fig. 9(a)) and the AlphaE (see Fig. 8(a)) are obtained from the exposures with the short spikes. An example is shown in Fig. 10(a).
2. The activity concentration C_r during the longer exposures was modeled by a rectangular or a step-like function. For that purpose, the average activity concentrations measured by the reference monitor AlphaGUARD were used as shown in Fig. 10(b).
3. Eq. (3) in the form of a sum is used to convolute F_R and C_r in order to obtain the response C_m of the monitors and to compare it with the real measurements of the monitors (see Figs. 10(c) and 10(d)).

The good agreement between the modeled response and the detectors measurements proves the feasibility of the approach. Thus, short spikes could be used to obtain the response function of the monitors and to model and predict their response.

4. Conclusions

The monitor RadonEye Plus2 was studied in respect to its application for continuous indoor radon monitoring with accent on follow-up of sharp variations. The linearity of the response and the reproducibility were studied by exposure of 36 RadonEye monitors to radon activity concentrations in the range 150–7000 Bq/m³. All RadonEyes showed

excellent linearity up to 3500 Bq/m³. A slight deviation from linearity within 12% was observed in the range 3500–7000 Bq/m³. The reproducibility of measurements by different RadonEyes in the range of linearity was within 7%.

In order to assess the applicability of the RadonEyes for follow-up of fast activity changes, their time response was studied and compared to that of other radon monitors. A dedicated procedure was developed based on exposure of the monitors to rectangular activity concentration pulses (spikes). It was demonstrated that an exposure system with a 50 l chamber and a small volume radon source connected in closed loop is suitable for creating such spikes. It was also shown that the monitor AlphaGUARD PQ2000 Pro Rn/Tn has a very fast response which makes it suitable for follow-up of the activity concentration in time response studies of other monitors. Additionally, an approach to obtain the response function of a monitor by exposing it to short radon spikes was developed. It is demonstrated that the response function could be used to model and predict the response of monitors with response times of the order of tens of minutes.

The determined characteristic response times of the RadonEye monitor are about 40 min for reaching 50% of the plateau of a rectangular pulse and 90 min for reaching 90%. They are somewhat higher than the corresponding response times of the AlphaE monitor, which are 20 and 60 min respectively. However, the sensitivity of the AlphaE is insufficient to follow changes in the radon activity concentration even at the level of a few kBq/m³. The response times of the RAD7

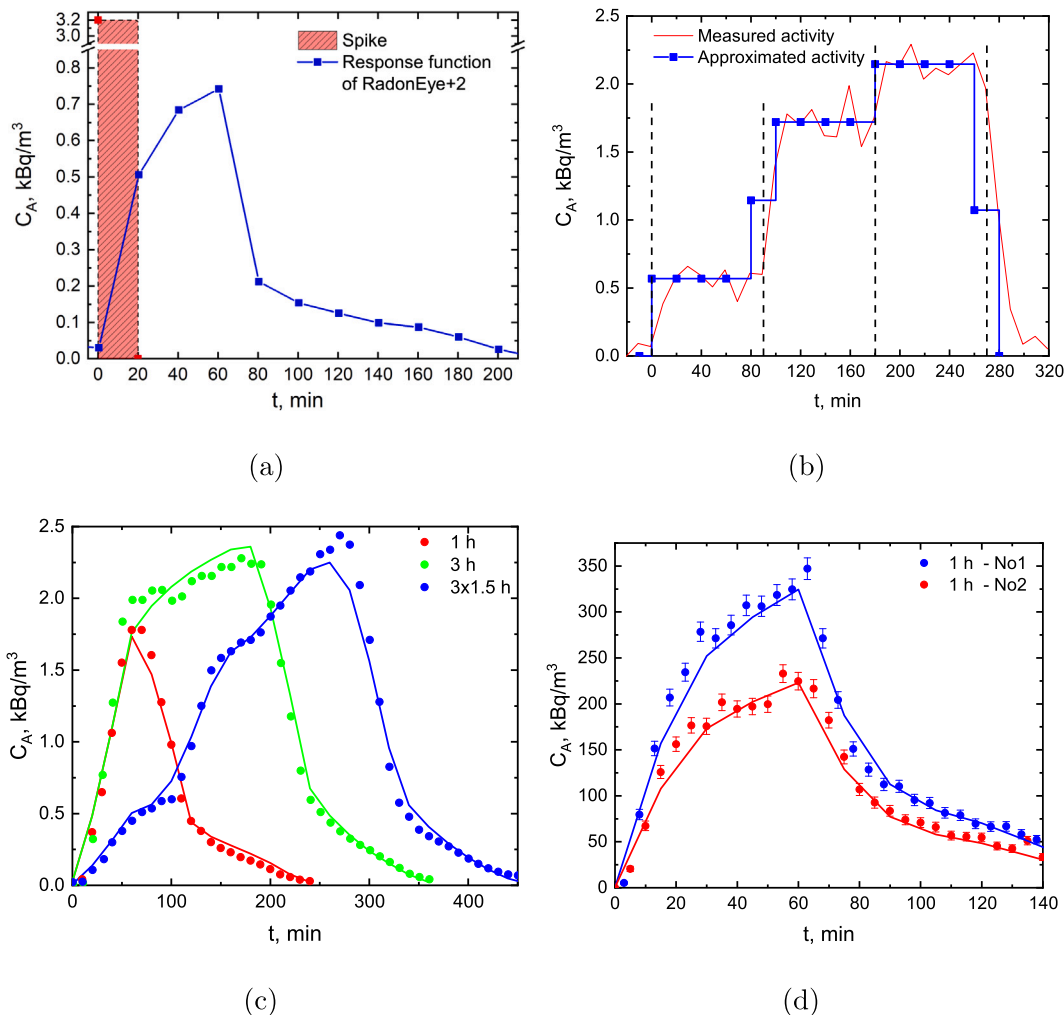

Fig. 10. (a) The response function F_R (blue) of a RadonEye yielded by the short activity spike (red). (b) The activity concentration measured by the AlphaGUARD (red) during the long exposures is modeled with the averaged activity concentration C_r (blue). The convolution of F_R and C_r gives the expected response of the monitor (Eq. (3)) – the blue solid line in (c) is the convolution of F_R and C_r , shown in (a) and (b). The expected response (solid lines) of a RadonEye (c) and an AlphaE monitor (d) are compared with their readings (the points) during the exposures.

monitor in sniff mode are much shorter — about 3 min for reaching 50% of the plateau of a rectangular pulse and 10 min for reaching 90%. The response of the AlphaGUARD monitor in flow-through mode is even faster — it reaches 95% of the plateau in less than 2 min. The differences of the response times of the monitors are attributed to the different isotopes (among radon and its progeny) used for signal formation and the different signal processing algorithms.

Overall, the RadonEye monitor seems useful for studies of indoor radon dynamics and estimation of the radon exposure based on the actual hours spent in a building. Its time response is sufficiently fast to follow radon variations even in buildings with active ventilation. It is linear in the range below 3500 Bq/m³ in which radon concentrations in the great majority of buildings are found. It demonstrates reasonable accuracy and reproducibility. Its affordable price makes it appropriate for measurement campaigns in dwellings and workplaces. Due to its high sensitivity, RadonEye can be useful in the process of radon mitigation or in the assessment of anti-radon systems.

The presented methodology can be applied to study other active monitors for continuous radon measurements. The developed procedure for characterization of the time response is applicable to a great variety of monitors. Such characterization allows to uncover the full potential of continuous monitors for new and evolving applications like estimation of the radon exposure in buildings with part-time operation, active radon mitigation through smart solutions and investigation of the nature and causes for indoor radon variations.

CRediT authorship contribution statement

Ivelina Dimitrova: Methodology, Formal analysis, Investigation, Data curation, Writing – original draft, Writing – review & editing, Project administration, Funding acquisition. **Strahil Georgiev:** Conceptualization, Methodology, Formal analysis, Investigation, Writing – original draft, Writing – review & editing, Visualization. **Krasimir Mitev:** Conceptualization, Methodology, Formal analysis, Investigation, Writing – review & editing. **Vladislav Todorov:** Investigation, Data curation, Writing – review & editing. **Chavdar Dutssov:** Investigation, Writing – review & editing. **Benoit Sabot:** Investigation, Resources, Writing – review & editing.

Declaration of competing interest

The authors declare that they have no known competing financial interests or personal relationships that could have appeared to influence the work reported in this paper.

Data availability

Data will be made available on request.

Acknowledgment

This research is funded by the Bulgarian National Science Fund under project SPIRAD, contact KP-06-H48/3 from 26.11.2020.

References

- [1] WHO, WHO Handbook on Indoor Radon: A Public Health Perspective, World Health Organization, ISBN: 978-92-4-154767-3, 2009, URL <https://www.who.int/publications/i/item/9789241547673>.
- [2] J. Rydock, A. Næss-Rolstad, J. Brunzell, Diurnal variations in radon concentrations in a school and office: implications for determining radon exposure in day-use buildings, *Atmos. Environ.* 35 (2001) 2921–2926, [http://dx.doi.org/10.1016/S1352-2310\(00\)00515-X](http://dx.doi.org/10.1016/S1352-2310(00)00515-X).
- [3] G. Venoso, A. Iacoponi, G. Pratesi, M. Guazzini, L. Boccini, E. Corbani, S. Bucci, F. Leonardi, R. Trevisi, M. Ampollini, S. Antignani, M. Caprio, C. Carpentieri, C. Di Carlo, F. Bochicchio, Impact of temporal variability of radon concentration in workplaces on the actual radon exposure during working hours, *Sci. Rep.* 11 (2021) 16984, <http://dx.doi.org/10.1038/s41598-021-96207-9>.
- [4] C. Groves-Kirkby, A. Denman, R. Crockett, P. Phillips, A. Woolridge, G. Gillmore, Time-integrating radon gas measurements in domestic premises: comparison of short-, medium- and long-term exposures, *J. Environ. Radioact.* 86 (2006) 92–109, <http://dx.doi.org/10.1016/j.jenvrad.2005.07.008>.
- [5] T. Turtiainen, K. Kojo, J.-P. Laine, O. Holmgren, P. Kurttio, Improving the assessment of occupational exposure to radon in above-ground workplaces, *Radiat. Prot. Dosim.* 196 (1–2) (2021) 44–52, <http://dx.doi.org/10.1093/rpd/ncab127>.
- [6] H. Baysson, S. Billon, D. Laurier, A. Rogel, M. Tirmarche, Seasonal correction factors for estimation radon exposure in dwellings in France, *Radiat. Prot. Dosim.* 104 (3) (2003) 245–252, <http://dx.doi.org/10.1093/oxfordjournals.rpd.a006188>.
- [7] Z. Daraktchieva, New correction factors based on seasonal variability of outdoor temperature for estimating annual radon concentrations in UK, *Radiat. Prot. Dosim.* 175 (1) (2017) 65–74, <http://dx.doi.org/10.1093/rpd/ncw270>.
- [8] J. Park, C.M. Lee, H.Y. Lee, D.R. Kang, Estimation of seasonal correction factors for indoor radon concentrations in Korea, *Int. J. Environ. Res. Public Health* 15 (10) (2018) 2251, <http://dx.doi.org/10.3390/ijerph15102251>.
- [9] J.C. Miles, Temporal variation of radon levels in houses and implications for radon measurement strategies, *Radiat. Prot. Dosim.* 93 (4) (2001) 369–376, <http://dx.doi.org/10.1093/oxfordjournals.rpd.a006449>.
- [10] RadonFTLab, Device operational manual [RD200], 2022, Online; accessed 07-Jun-2022. URL <http://radonftlab.com/download/>.
- [11] RadonFTLab, Radon eye RD200 & RD200M, smart radon detector & module, datasheet v1.4, 2022, Online; accessed 07-Jun-2022. URL http://radonftlab.com/wp-content/uploads/2015/data_sheet/datasheet_RD200_v1.4_eng.pdf.
- [12] M.-M. Bé, V. Chisté, C. Dulieu, E. Browne, V. Chechev, N. Kuzmenko, R. Helmer, A. Nichols, E. Schönfeld, R. Dersch, Monographie BIPM-5: Table of Radionuclides, Vol. 2, Bureau International des Poids et Mesures, France, ISBN: 92-822-2207-1, 2004, URL <https://www.bipm.org/en/publications/monographies>.
- [13] MetroRADON, Metrology for radon monitoring (EMPIR 16ENV10), 2022, Online; accessed 07-Jun-2022. URL <http://metroradon.eu/>.
- [14] T. Turtiainen, K. Mitev, R. Dehqanzada, O. Holmgren, S. Georgiev, Testing of thoron cross-interference of continuous radon measuring instruments, *J. Eur. Radon Assoc.* 3 (2022) <http://dx.doi.org/10.35815/radon.v3.7694>.
- [15] Saphymo, AlphaGUARD – User manual, 2022, Online; accessed 07-Jun-2022. URL https://www.bertin-instruments.com/wp-content/uploads/secured-file/ALGU_Manual_2012-08_E.pdf.
- [16] Durrage, RAD7 – User manual, 2022, Online; accessed 07-Jun-2022. URL <https://durrige.com/support/product-manuals/>.
- [17] Saphymo, AlphaE – User manual, 2022, Online; accessed 07-Jun-2022. URL https://www.bertin-instruments.com/wp-content/uploads/secured-file/AlphaE_Manual_E-2014-03.pdf.
- [18] D. Pressyanov, K. Mitev, S. Georgiev, I. Dimitrova, J. Kolev, Laboratory facility to create reference radon + thoron atmosphere under dynamic exposure conditions, *J. Environ. Radioact.* 166 (2017) 181–187, <http://dx.doi.org/10.1016/j.jenvrad.2016.03.018>.
- [19] B. Sabot, Calibration of Thoron Activity Concentration Monitors (Ph.D. thesis), Gif-sur-Yvette, France, 2015, URL <https://tel.archives-ouvertes.fr/tel-01253649>.
- [20] B. Sabot, S. Pierre, N. Michielsen, S. Bondiguel, P. Cassette, A new thoron atmosphere reference measurement system, *Appl. Radiat. Isot.* 109 (2016) 205–209, <http://dx.doi.org/10.1016/j.apradiso.2015.11.055>.
- [21] K. Mitev, S. Georgiev, B. Sabot, Approaches for reduction of the temperature bias on radon detectors packed in anti-thoron polymer membranes, *Appl. Radiat. Isot.* 177 (2021) 109915, <http://dx.doi.org/10.1016/j.apradiso.2021.109915>.
- [22] K. Mitev, P. Cassette, D. Pressyanov, S. Georgiev, C. Dutsov, N. Michielsen, B. Sabot, Methods for the experimental study of ²²⁰Rn homogeneity in calibration chambers, *Appl. Radiat. Isot.* 165 (2020) 109259, <http://dx.doi.org/10.1016/j.apradiso.2020.109259>.
- [23] Yantel, nanoMCA, product information, 2022, Online; accessed 07-Jun-2022. URL <https://www.yantel.com/products/nanomca/>.
- [24] M.-M. Bé, V. Chisté, C. Dulieu, E. Browne, V. Chechev, N. Kuzmenko, F. Kondev, A. Luca, M. Galán, A. Pearce, X. Huang, Monographie BIPM-5: Table of Radionuclides, Vol. 4, Bureau International des Poids et Mesures, France, ISBN: 92-822-2230-6, 2008, URL <https://www.bipm.org/en/publications/monographies>.