



**HAL**  
open science

## **SXR measurement and associated inversion: a crucial tool for controlling fusion performances**

Didier Mazon, Alexandre Jardin, Colette Damien, Geert Verdoolaege, T. Wang, Philippe Malard, M. Walsh, M. Scholz, K. Krol

### ► **To cite this version:**

Didier Mazon, Alexandre Jardin, Colette Damien, Geert Verdoolaege, T. Wang, et al.. SXR measurement and associated inversion: a crucial tool for controlling fusion performances. ICFDT6 - 6th International Conference Frontiers in Diagnostic technologies, Oct 2022, Frascati, Italy. cea-03863082

**HAL Id: cea-03863082**

**<https://cea.hal.science/cea-03863082v1>**

Submitted on 21 Nov 2022

**HAL** is a multi-disciplinary open access archive for the deposit and dissemination of scientific research documents, whether they are published or not. The documents may come from teaching and research institutions in France or abroad, or from public or private research centers.

L'archive ouverte pluridisciplinaire **HAL**, est destinée au dépôt et à la diffusion de documents scientifiques de niveau recherche, publiés ou non, émanant des établissements d'enseignement et de recherche français ou étrangers, des laboratoires publics ou privés.

# 6th International Conference Frontiers in Diagnostic Technologies (ICFDT6) 19-21.10.2022, Frascati



**SXR measurement and associated  
inversion: a crucial tool for  
controlling fusion performances**

DE LA RECHERCHE À L'INDUSTRIE

**D. Mazon , A. Jardin, Y. Peysson, D. Colette, T. Wang, G. Verdoolaege, P.  
Malard, M. Walsh, M. Scholz, K. Krol**

Didier Mazon



- ❑ Challenges in tokamak: high T, neutrons, gammas...
- ❑ Most common SXR detectors today: **semiconductor diodes**,
- BUT**: ITER, DEMO → too high heat / neutron flux in D-T phase,
- ❑ Neutron resilient technologies essential for ITER [Hu 2017]
- Foreseen techno.: GEM [Mazon 2015], LVIC [Colette 2020], ...

### Semiconductor based detectors:

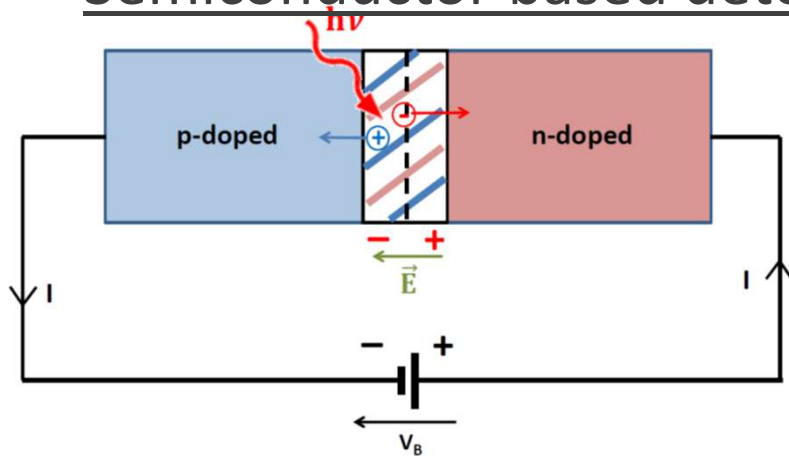

### Gaseous detectors:

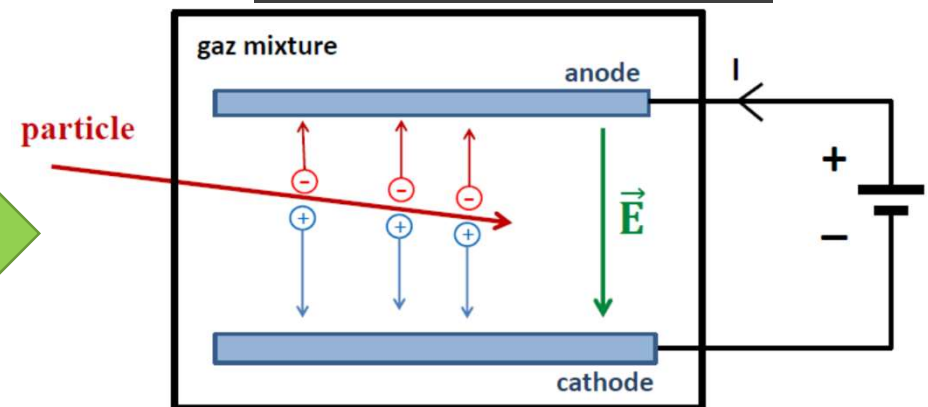

### ❑ GEM-based SXR diagnostic of WEST:

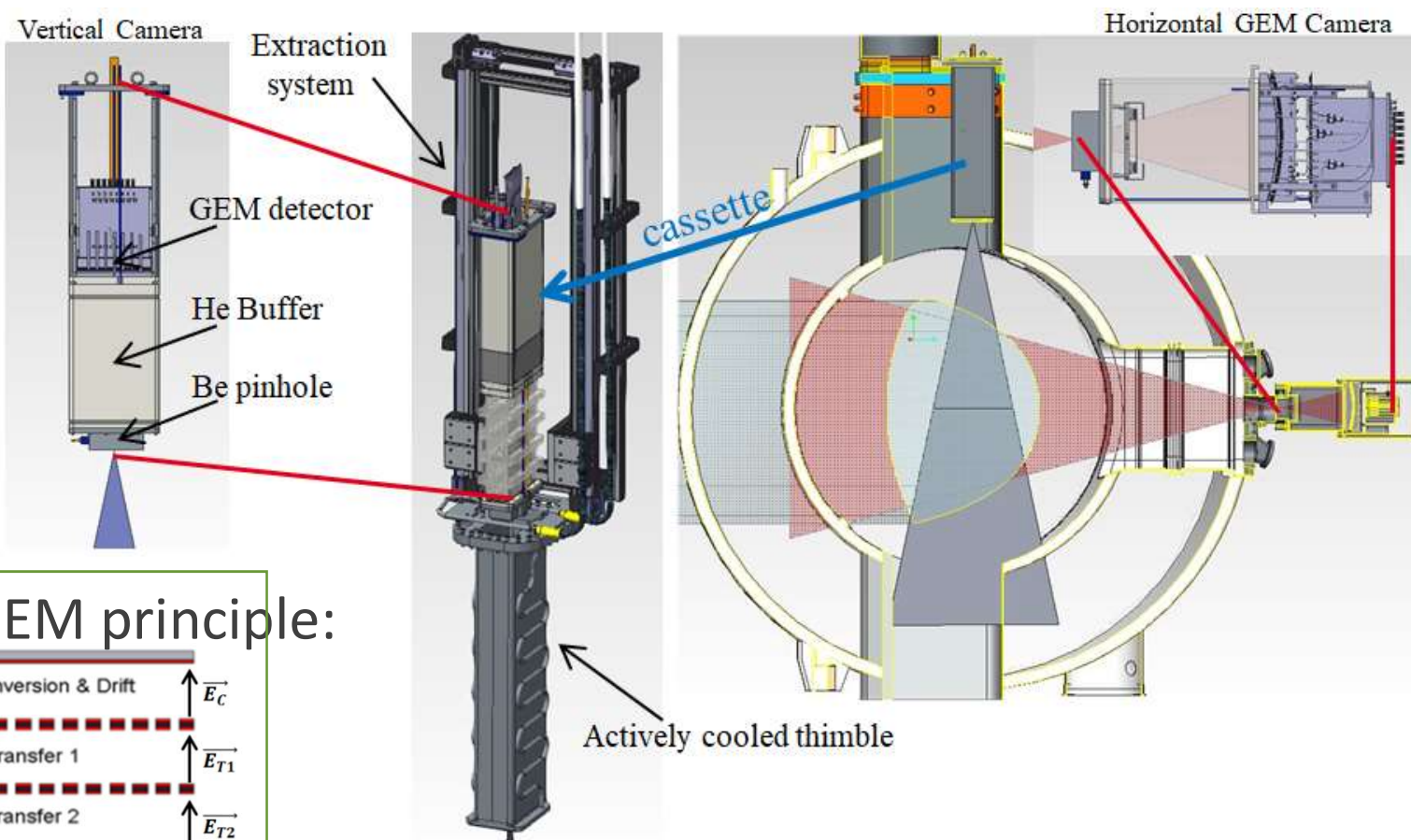

### Triple-GEM principle:

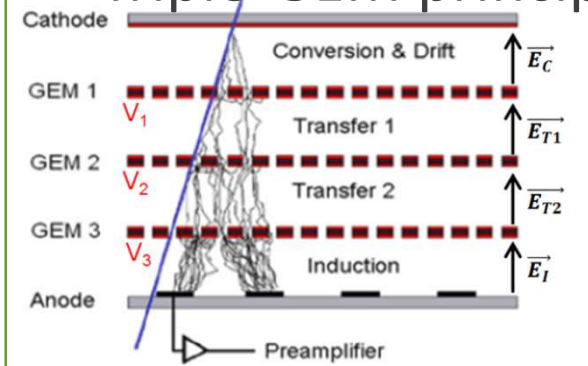

[D. Mazon et al., JINST 2017]

## LVIC concept proposed in [Gott 2009]:

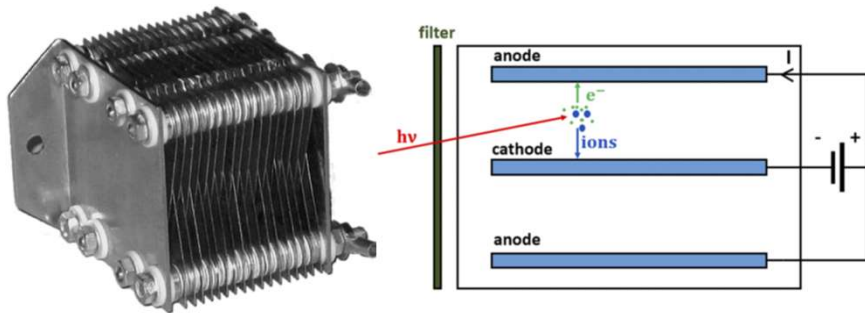

[Y.V. Gott, M.M. Stepanenko, Instrum Exp Tech 52, 260-264 (2009)]

## Modeled line-integrated SXR spectrum

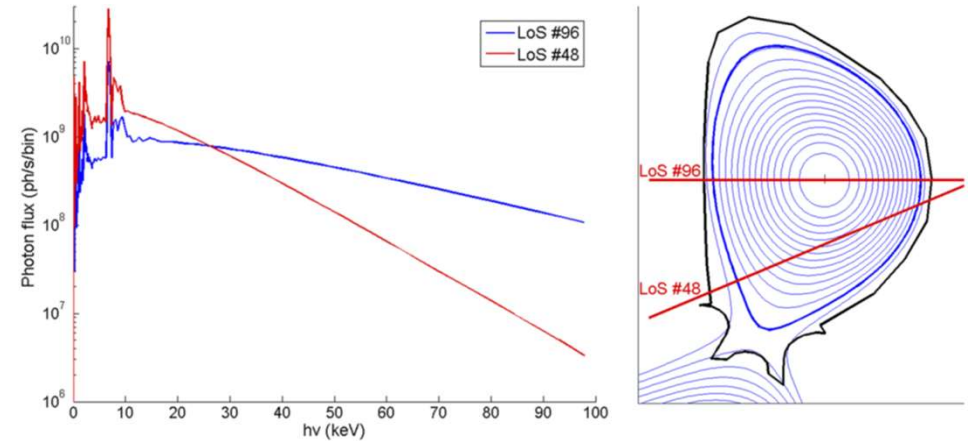

## ITER SXR radial cameras [Colette 2020]

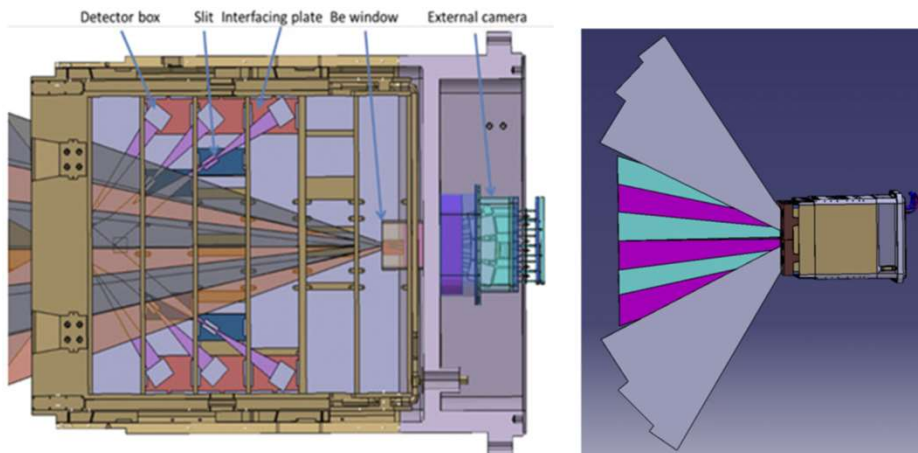

## X-ray tomographic reconstruction ( $W.m^{-3}$ )

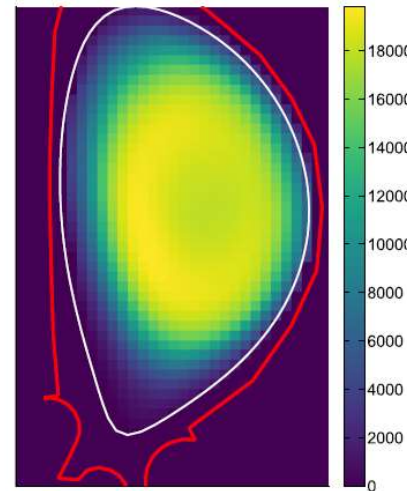

## Reconstruction relative error (%)

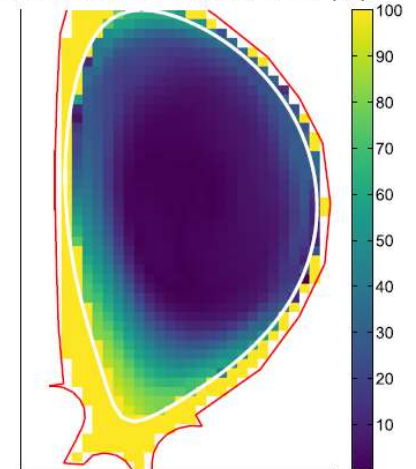

[D. Colette, D. Mazon et al, Rev. Sci. Instrum. 91, 073504 (2020)]

□ LVIC prototype tests in lab:

Experimental setup for SXR generation and measurements

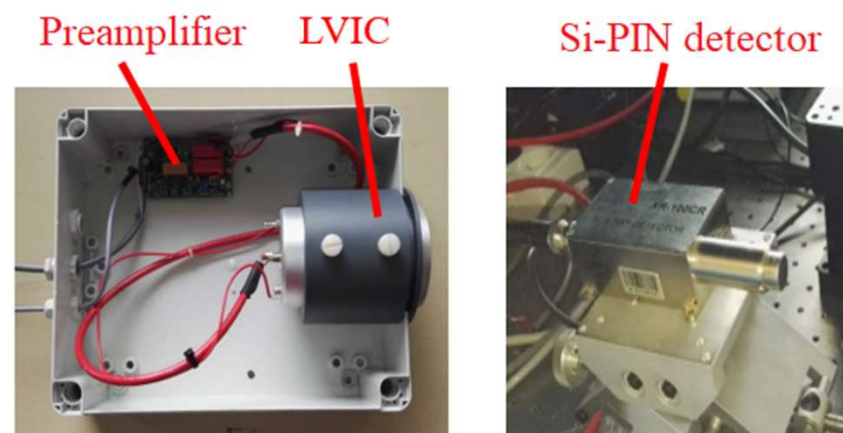
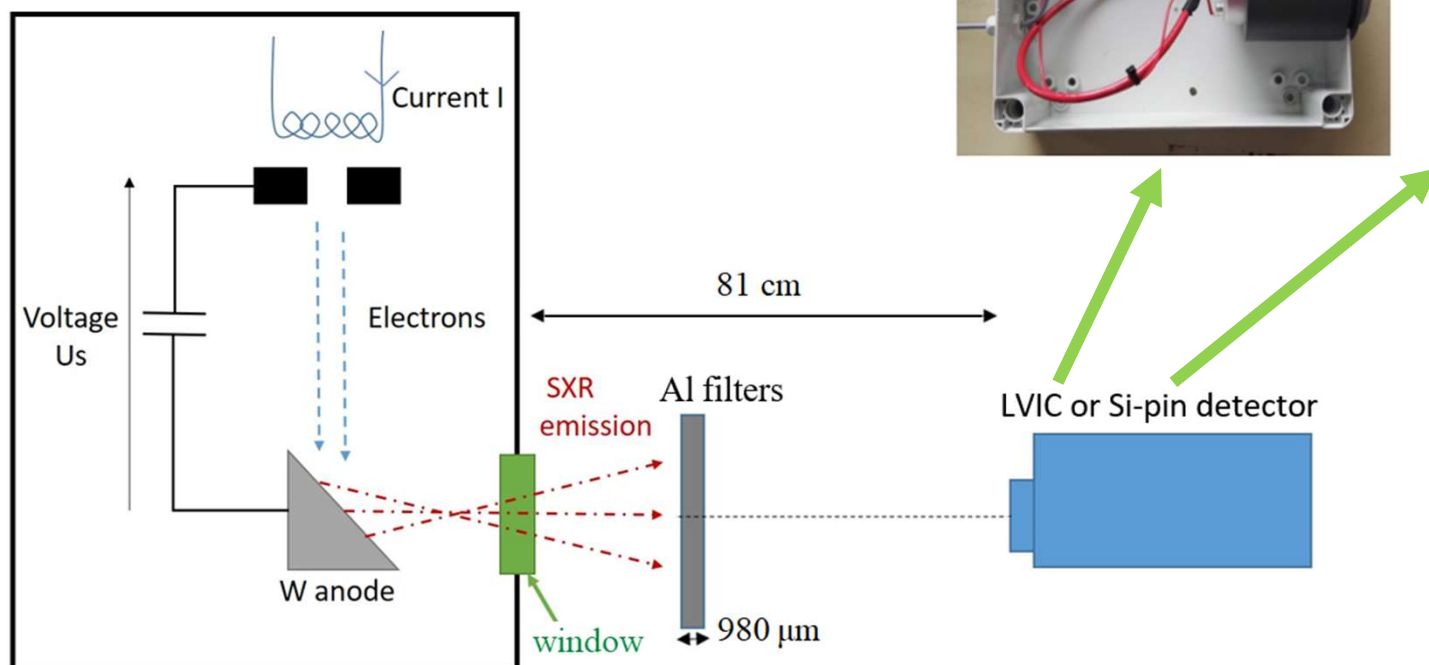

[D. Mazon et al., accepted to RSI (2022)]

### Estimated incident spectrum on the LVIC entrance window (after air + Al filters)

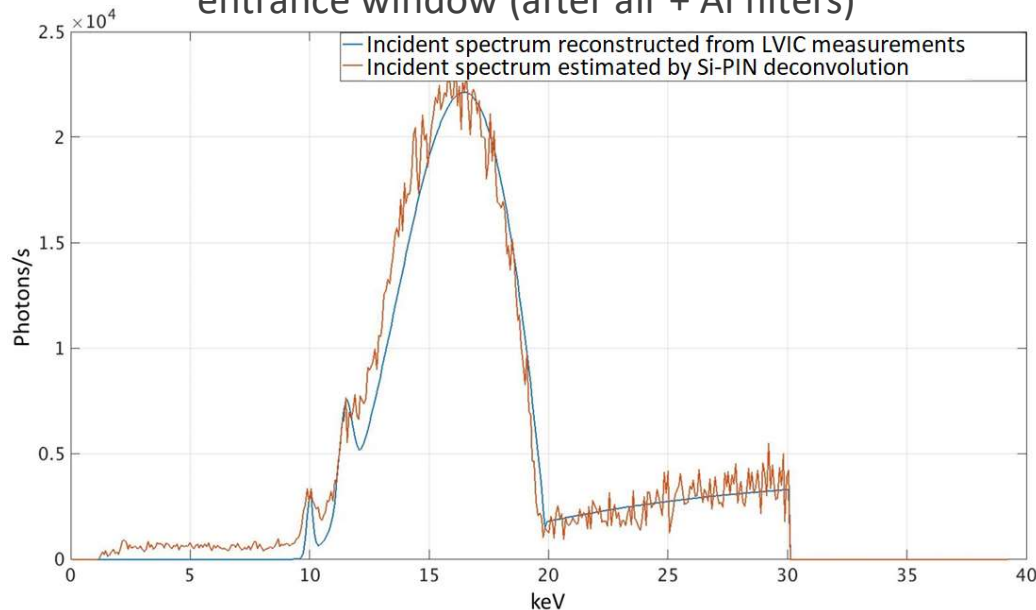

- Assumption on the incident SXR spectrum:

$$\phi(h\nu) = X_1 e^{-\frac{(h\nu - h\nu_1)^2}{2\sigma_1^2}} + X_2 e^{-\frac{(h\nu - h\nu_2)^2}{2\sigma_2^2}} + X_3 - X_4 h\nu$$

$$h\nu_1 = 09.96 \text{ keV (W L}\beta \text{ line),}$$

$$h\nu_2 = 11.42 \text{ keV (W L}\gamma \text{)}$$

Iterative optimization procedure with least-square minimization

$$\{X_i\}_{i=1..5} = \arg \min \|I_{meas} - I_{synt}(\phi(X))\|$$

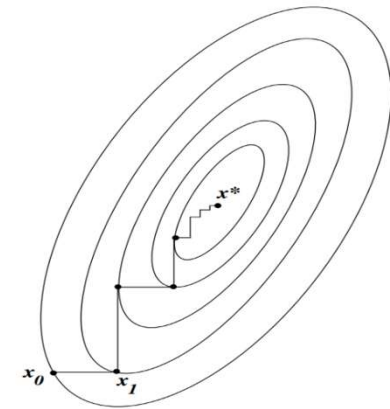

### Experimental results – model validation

Al filter width ( $\mu\text{m}$ )	Measured voltage (mV)	Simulated voltage (mV)	Relative error (%)
969	7.36	7.71	4.5
0	191.22	203.29	5.9

[D. Mazon et al., accepted to RSI (2022)]

- Soft X-rays (SXR) in the energy range 0.1 keV – 20 keV can provide valuable information, through 2D tomography, on:

- Impurity transport,
- Magnetohydrodynamic (MHD) activity, (e.g. sawtooth crash in ASDEX-U)
- Magnetic equilibrium.  
(plasma positioning)

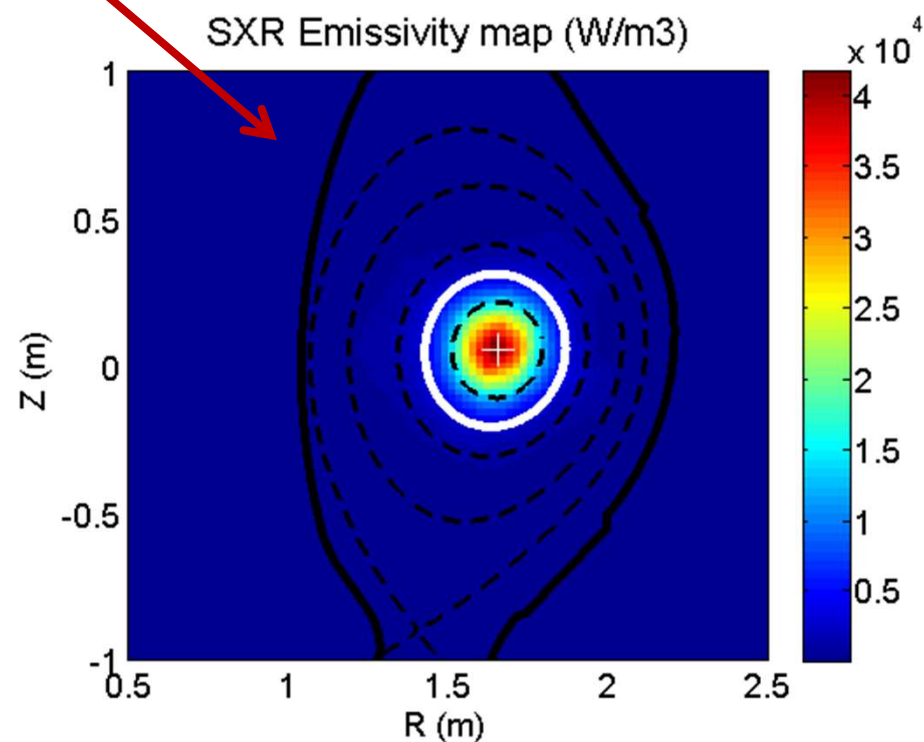
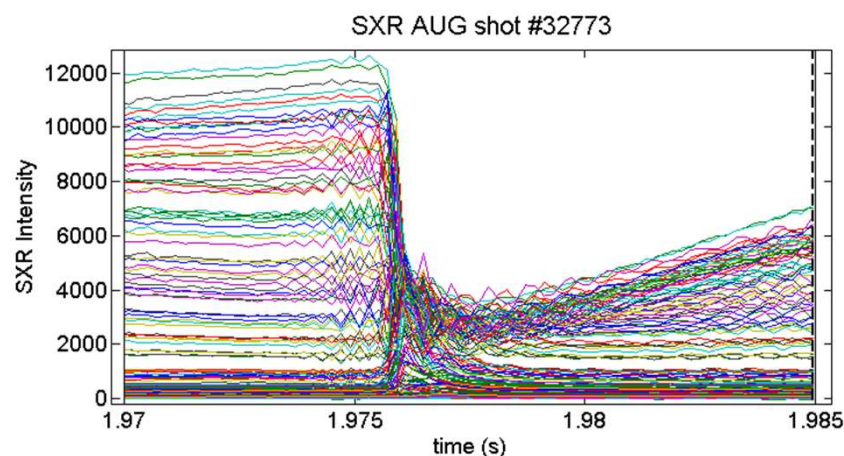



- Impurity force balance equation on a magnetic flux surface:

$$\frac{m_z n_z \omega^2}{2} \nabla_{\parallel} R^2 + Z n_z e \nabla_{\parallel} \Phi + T_z \nabla_{\parallel} n_z = R_{z,\parallel}$$

inertia (centrifugal)
electrostatic
pressure
friction

[Reinke PPPL Seminar 2015]

Neutral Beam Injection (NBI):

Ion Cyclotron Resonance Heating (ICRH)

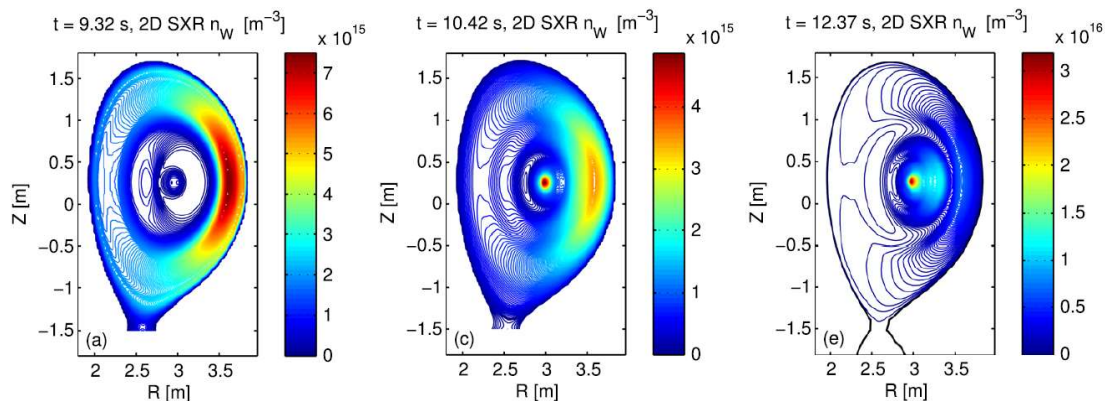

W 2D density distribution evolution with 17 MW of NBI (JET #83351)

[C. Angioni et al., PoP 2015]

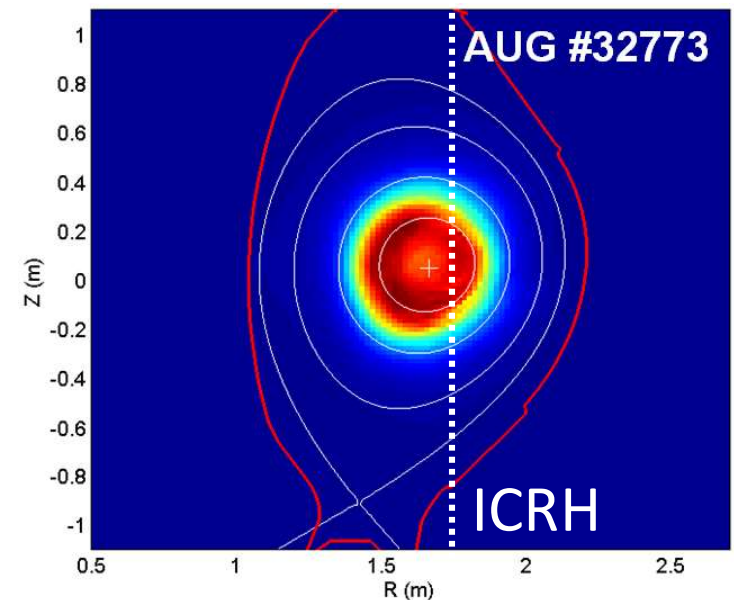

❑ Radiated power of impurities:  $P_{rad,Z} = n_e^2 c_Z L_Z(T_e)$

electron density ( $m^{-3}$ )

Impurity concentration

Cooling factor of Z ( $W.m^3$ )

electron temperature (keV)

❑ Impurity radiation increases with atomic number Z (high-Z):

Dominant radiation processes:

- **Bremsstrahlung**  
(free-free)
- **Radiative recombination**  
(free-bound)
- **Line radiation**  
(bound-bound)

**Soft X-ray range**  
**[0.1 keV – 20 keV]**

Cooling factor  $L_Z(T_e)$  of different elements

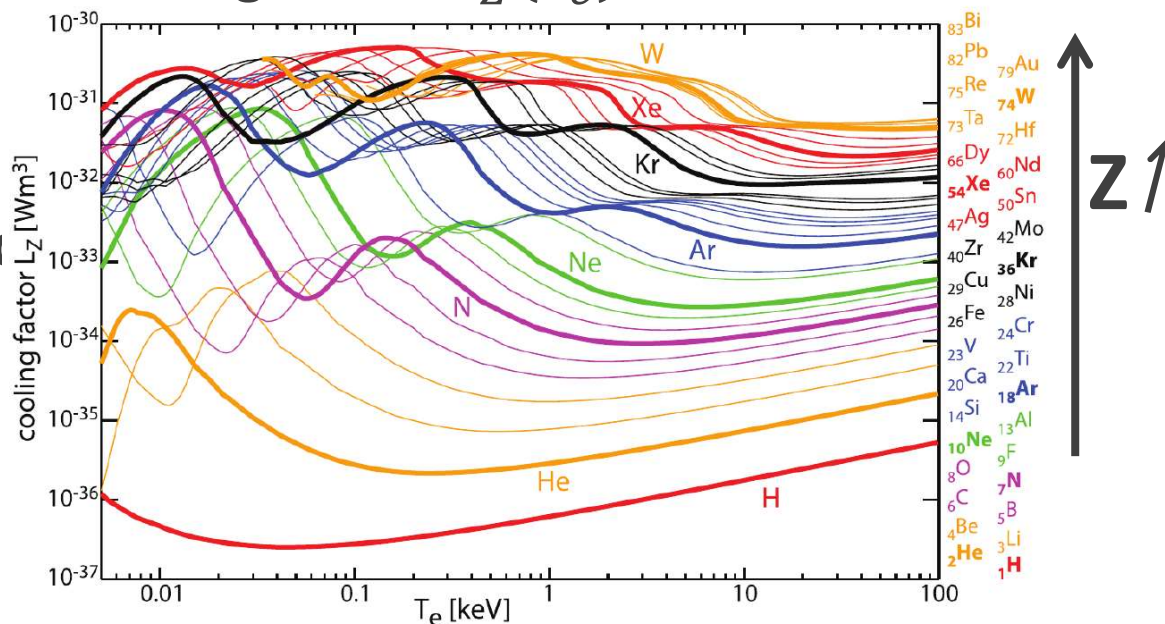

[Puetterich NF 2019]

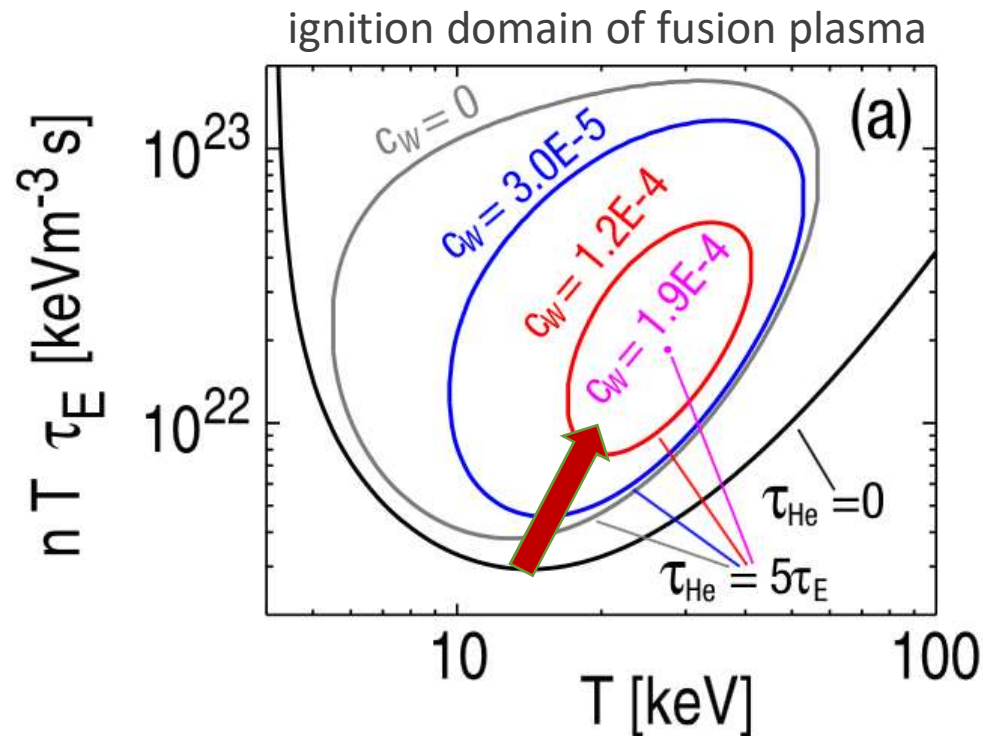

$T$  [keV] – plasma temperature

$n$  [ $1/m^3$ ] – plasma density

$\tau_E$  [s] – energy confinement time

$\tau_{He}$  – Helium confinement time

$c_W$  – impurity concentration (W)

[T. Putterich et al., Nuclear Fusion 50 (2), 025012 (2010)]

□ A concentration  $f_W < 0.01\%$  is a requirement for a fusion reactor

→ Diagnostic tools and actuators to control the tungsten core concentration are required!

- Reconstruction of the plasma 2D emissivity from line-integrated measurements, through 2D tomography → **ill-posed problem**

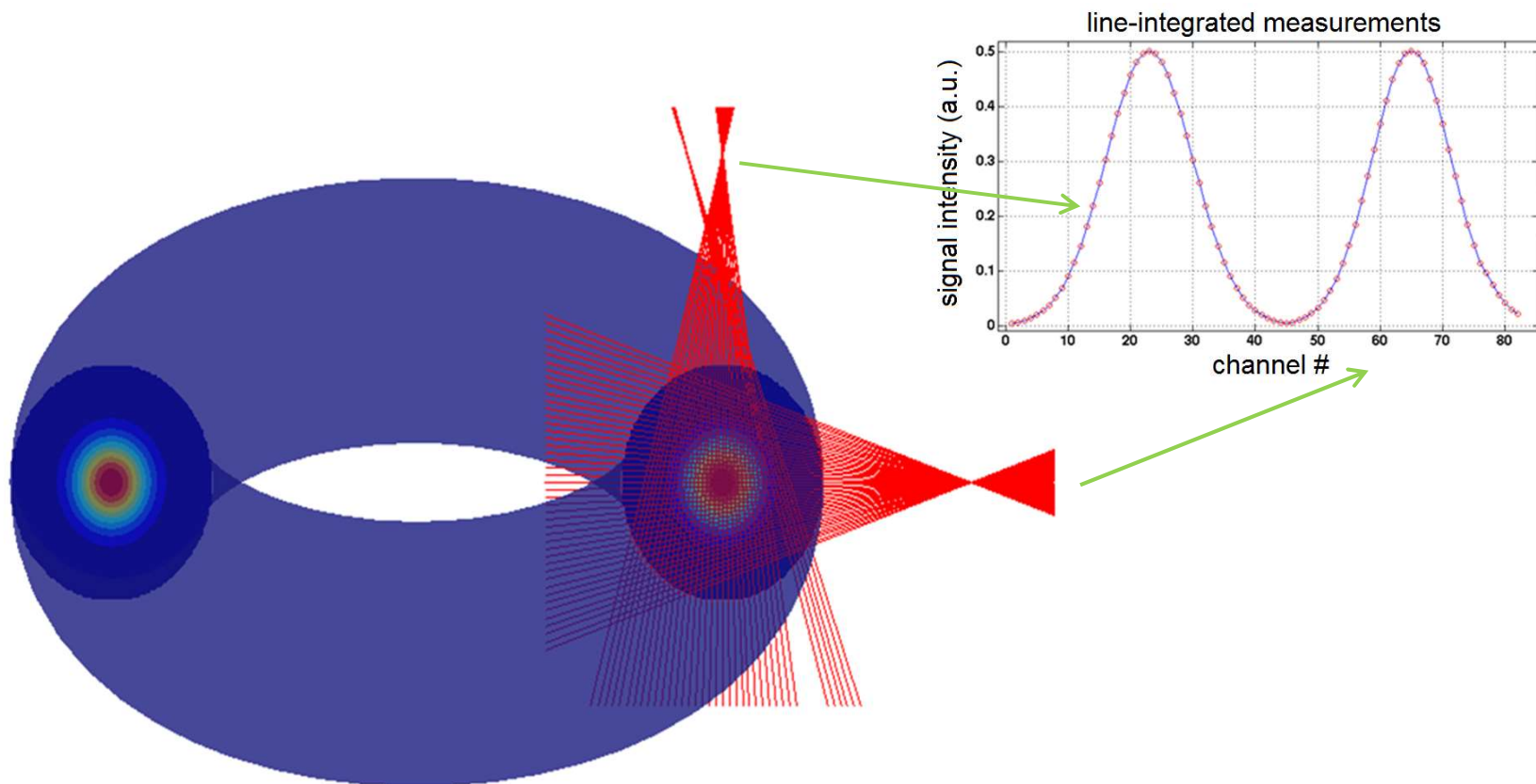

Example: Tore Supra SXR diagnostic



*Andrej Tikhonov*

$$\mathbf{m} = \mathbf{T} \cdot \boldsymbol{\varepsilon} + \tilde{\mathbf{m}}$$

measurements vector

Transfer matrix

2D emissivity

noise

□ Inversion problem: minimization of a functional:

$$\boldsymbol{\varepsilon}_{rec} = \arg \min_{\boldsymbol{\varepsilon}} (\chi^2(\boldsymbol{\varepsilon}) + \lambda \cdot \mathbf{R})$$

- Reconstruction error:  $\chi^2(\boldsymbol{\varepsilon}) = \|\mathbf{m} - \mathbf{T} \cdot \boldsymbol{\varepsilon}\|^2$
- Regularization term:  $\mathbf{R} = {}^t\boldsymbol{\varepsilon} \cdot \mathbf{H} \cdot \boldsymbol{\varepsilon}$
- Regularization param.:  $\lambda$

→ Solution:  $\boldsymbol{\varepsilon}_{rec} = (\mathbf{T} \cdot \mathbf{T} + \lambda \mathbf{H})^{-1} \cdot \mathbf{T} \cdot \mathbf{m}$

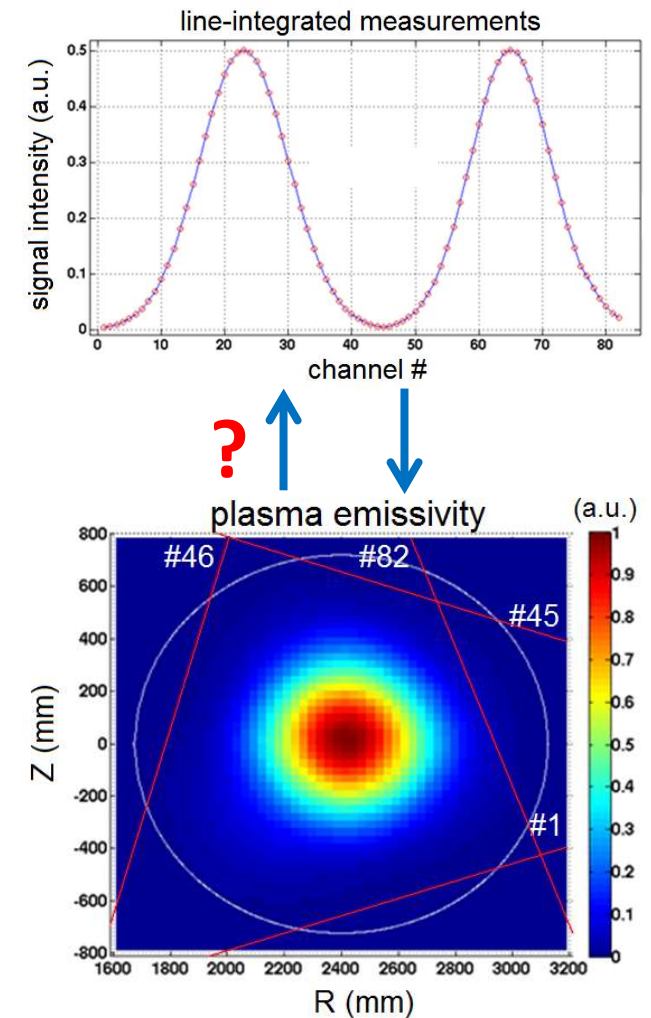

- $\lambda$  acts as a trade-off between smoothing of the solution and fitting of the SXR measurements:

$$\varepsilon_0 = \arg \min_{\varepsilon} (\chi^2(\varepsilon) + \lambda \cdot R(\varepsilon))$$

- For example: L-curve, discrepancy principle

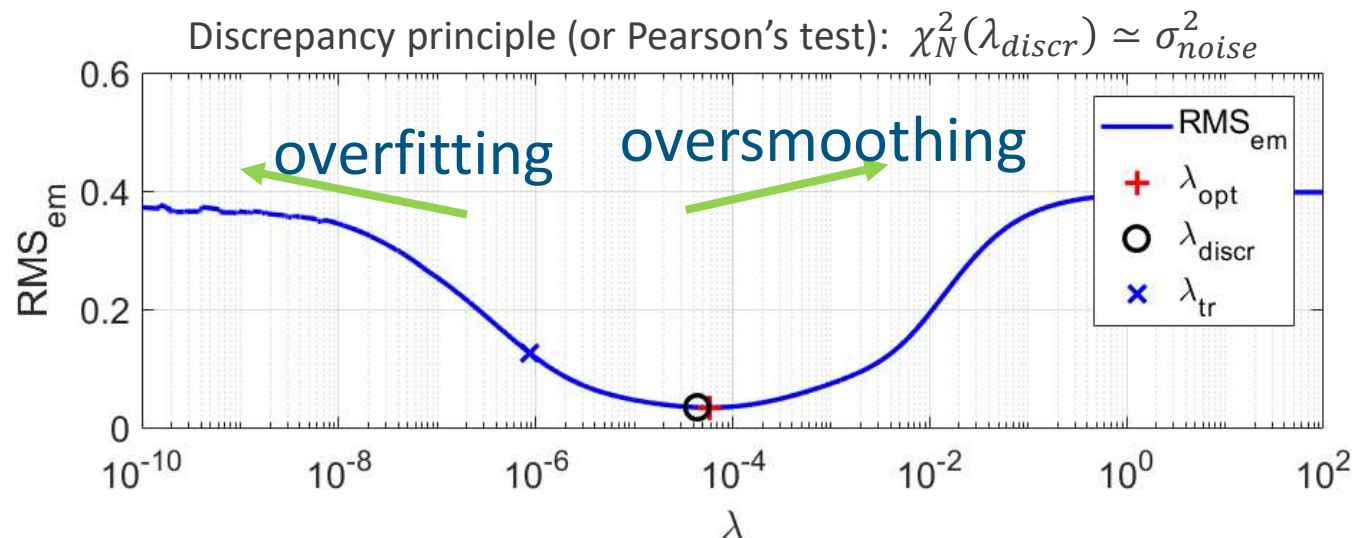
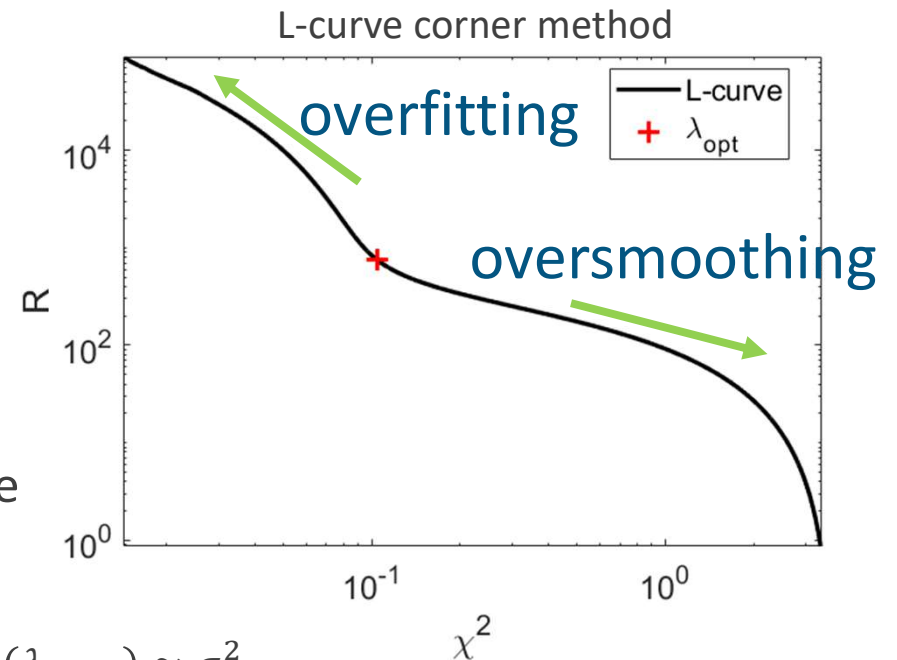

- Anisotropic regularization (with magnetic equilibrium) is introduced for the WEST configuration:

$$\mathbf{H}_{\text{MFI}} = (1 - \tau) {}^t\nabla_{\parallel} \cdot \mathbf{W} \cdot \nabla_{\parallel} + \tau {}^t\nabla_{\perp} \cdot \mathbf{W} \cdot \nabla_{\perp}$$

anisotropy factor:  $0 < \tau < 0.5$

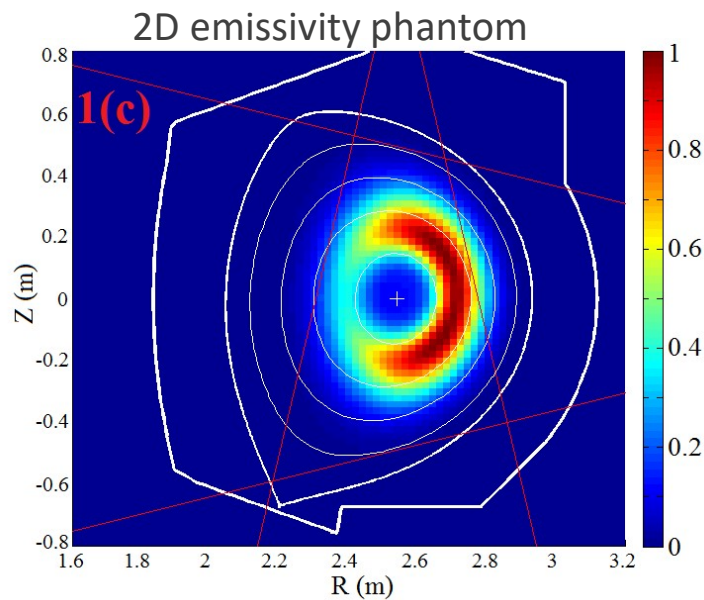

[Jardin et al, JINST 2016]

+ magnetic  
equilibrium

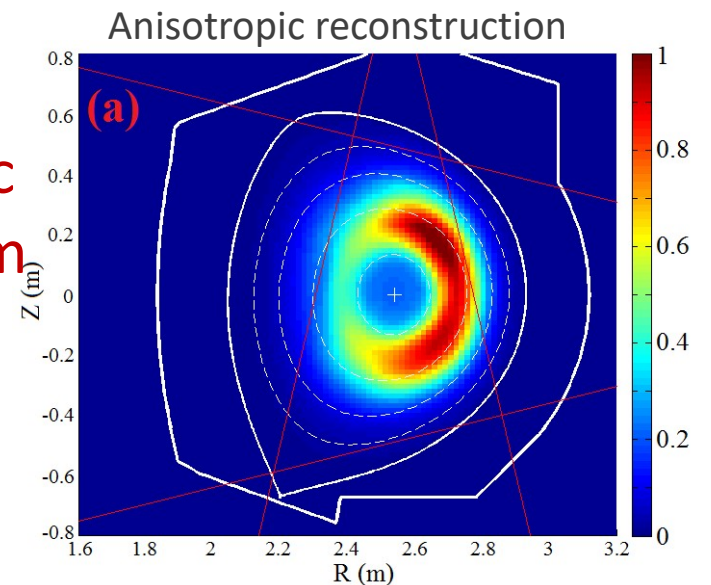
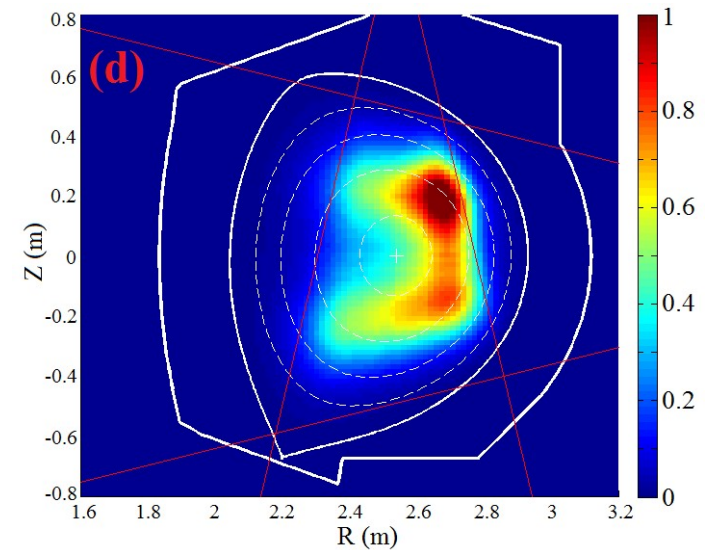

## □ Control of W concentration?

- Reduce W sources (erosion)
- Higher pumping rate
- Avoid strong W poloidal asymmetries
- Central ECRH (pump-out effect)
- Shape plasma profiles: peaked  $T_e$  (temperature screening)
- Trigger mitigating/flushing MHD: sawteeth (core), ELMs (edge)...

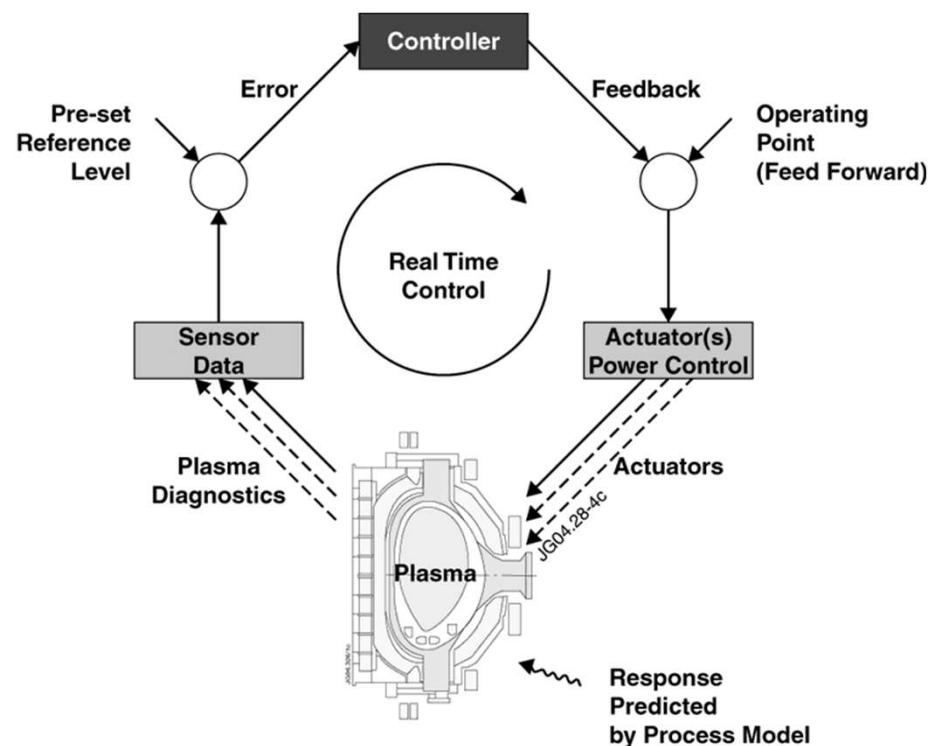

→ Possibility of real-time X-ray tomography?



- ❑ Issue of traditional Tikhonov approach: computing time  $> 0.01 - 10$  s
- ❑ Fast tomography for real-time control  $< 0.1$  ms  $\rightarrow$  **Neural networks**  
Neural Network: successive neuron layers connecting inputs and outputs.  
Neuron biases and weights are iteratively adjusted by training from a dataset.

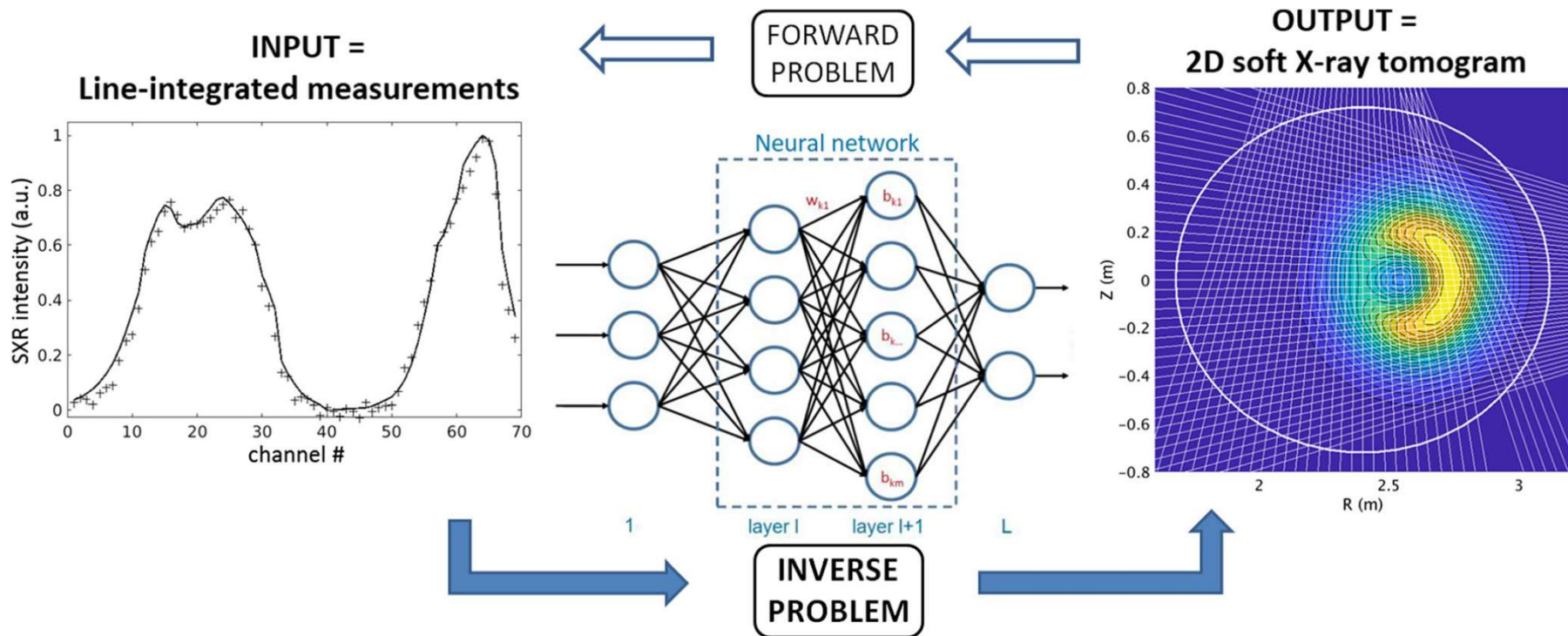

[A. Jardin (D. Mazon) et al., Neural networks: from image recognition to tokamak plasma tomography, 2019 *Laser and Particle Beams* 1–5]

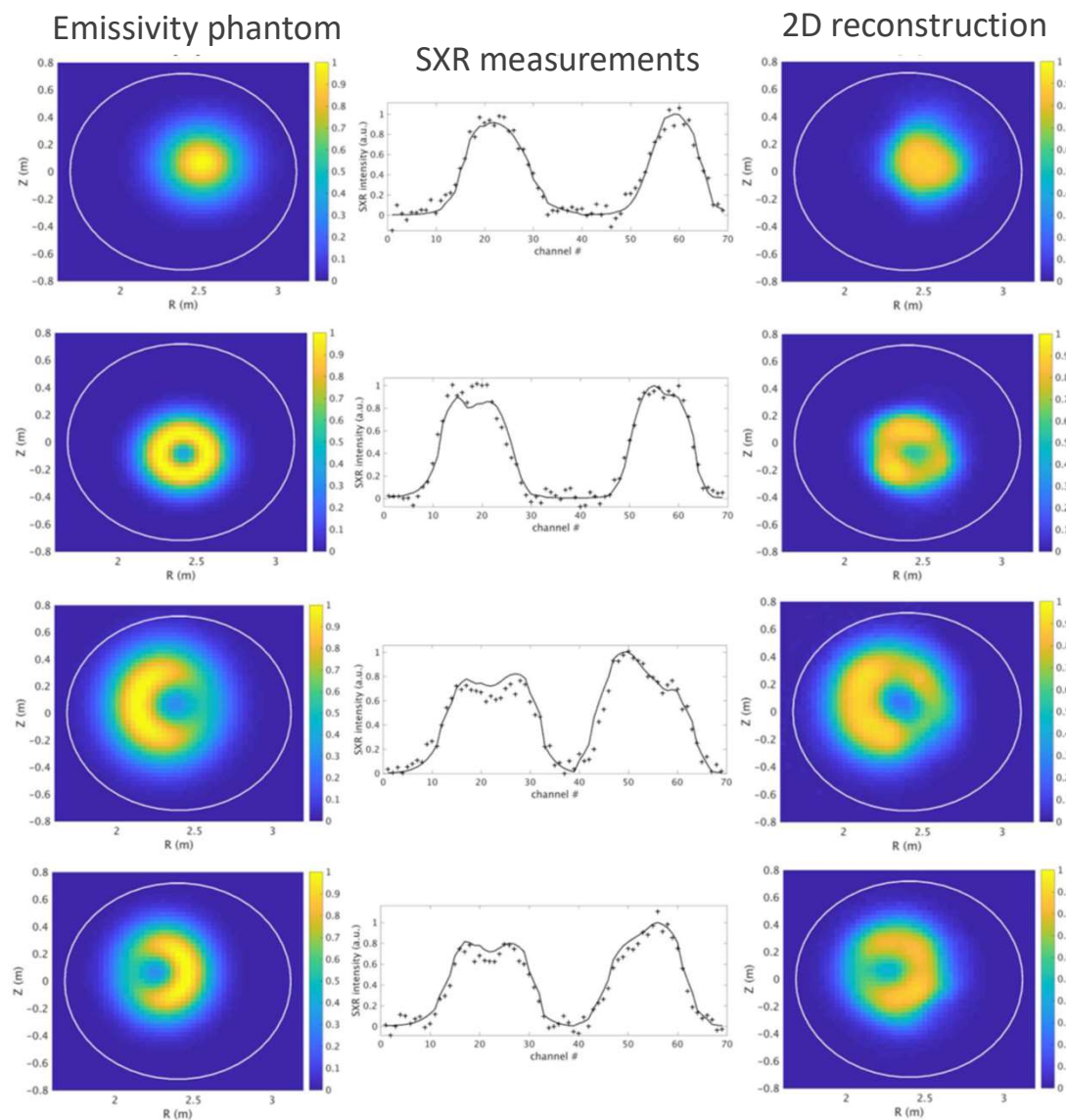

- Large training database to optimize the network parameters  $(\vec{w}, b)$
- Minimization of a Cost Function (MSE) with stochastic gradient-descent method:

$$C(\vec{w}, b) = \frac{1}{2n} \sum_x [y(x) - a(x, \vec{w}, b)]^2$$

desired output
output from the network

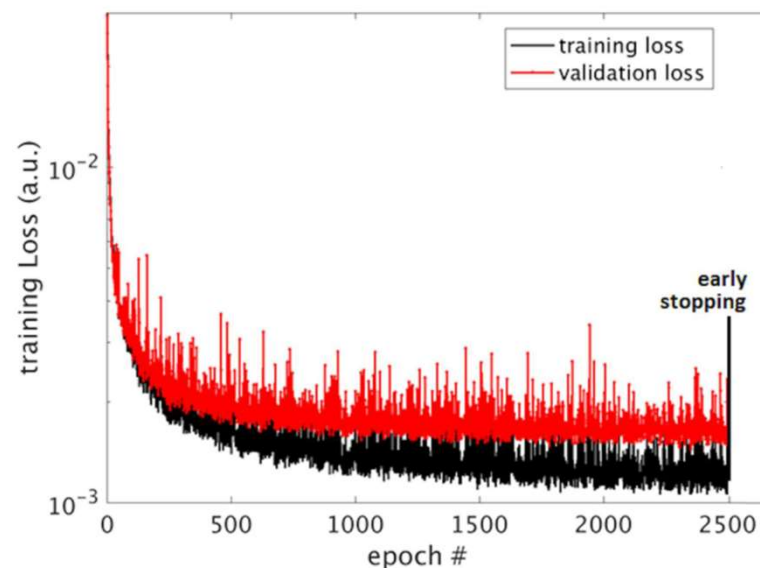

□ Controlled injection of tungsten impurities in Tore Supra:

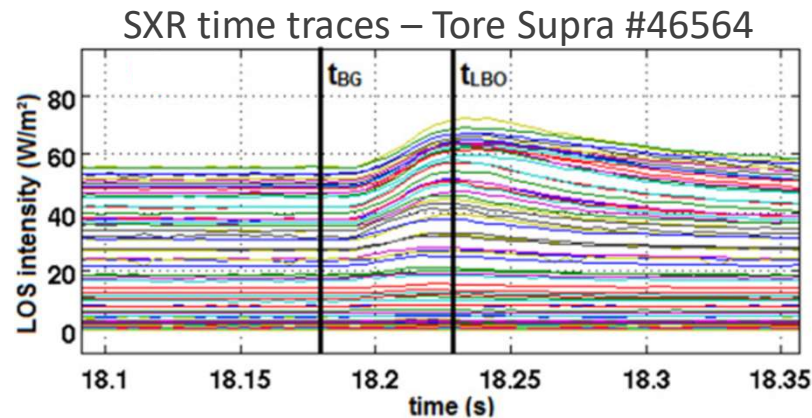

[A. Jardin (D. Mazon) et al, Acta  
Phys. Pol. A, 138 (2020) 626-631]

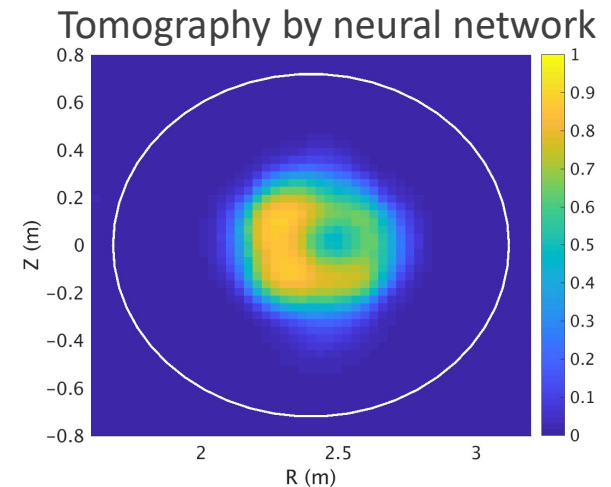
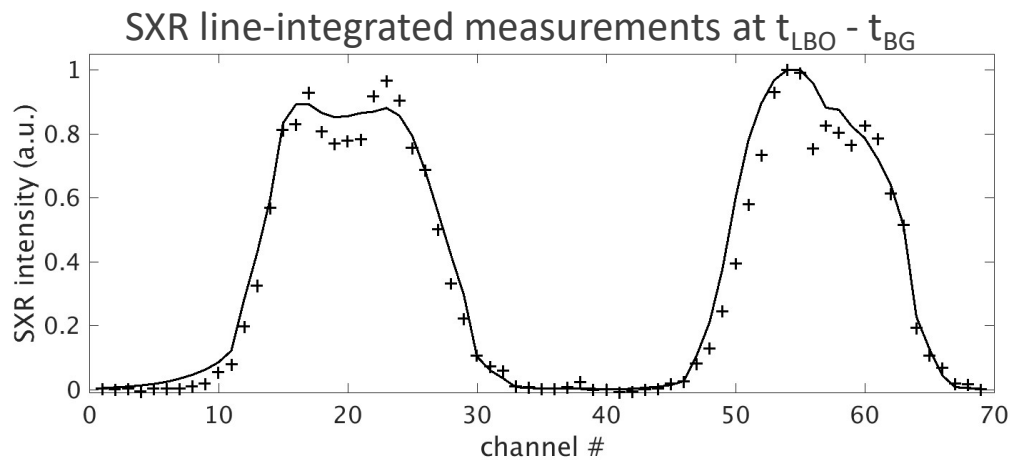

→ Consistent with traditional Tikhonov method but fast enough for real-time control ( $< 0.1$  ms)

Posterior information:

- What is the probability distribution of the emissivity, given the measurements?
- What is the most likely emissivity, given the measurements, and how certain are we?



Prior information:

- What are the possible emissivity fields before taking measurements?



$$p(\textit{emissivity} | \textit{measurement}) \sim p(\textit{measurement} | \textit{emissivity}) p(\textit{emissivity})$$



Likelihood forward model:

- Suppose we would know the emissivity field, to what measurements would it lead?

*T. Wang, D. Mazon, J. Svensson, D. Li, A. Jardin and G. Verdoolaeye. Gaussian Process tomography for soft X-ray spectroscopy at WEST without equilibrium information. Rev Sci Instrum. 2018 Jun. 89(6).*

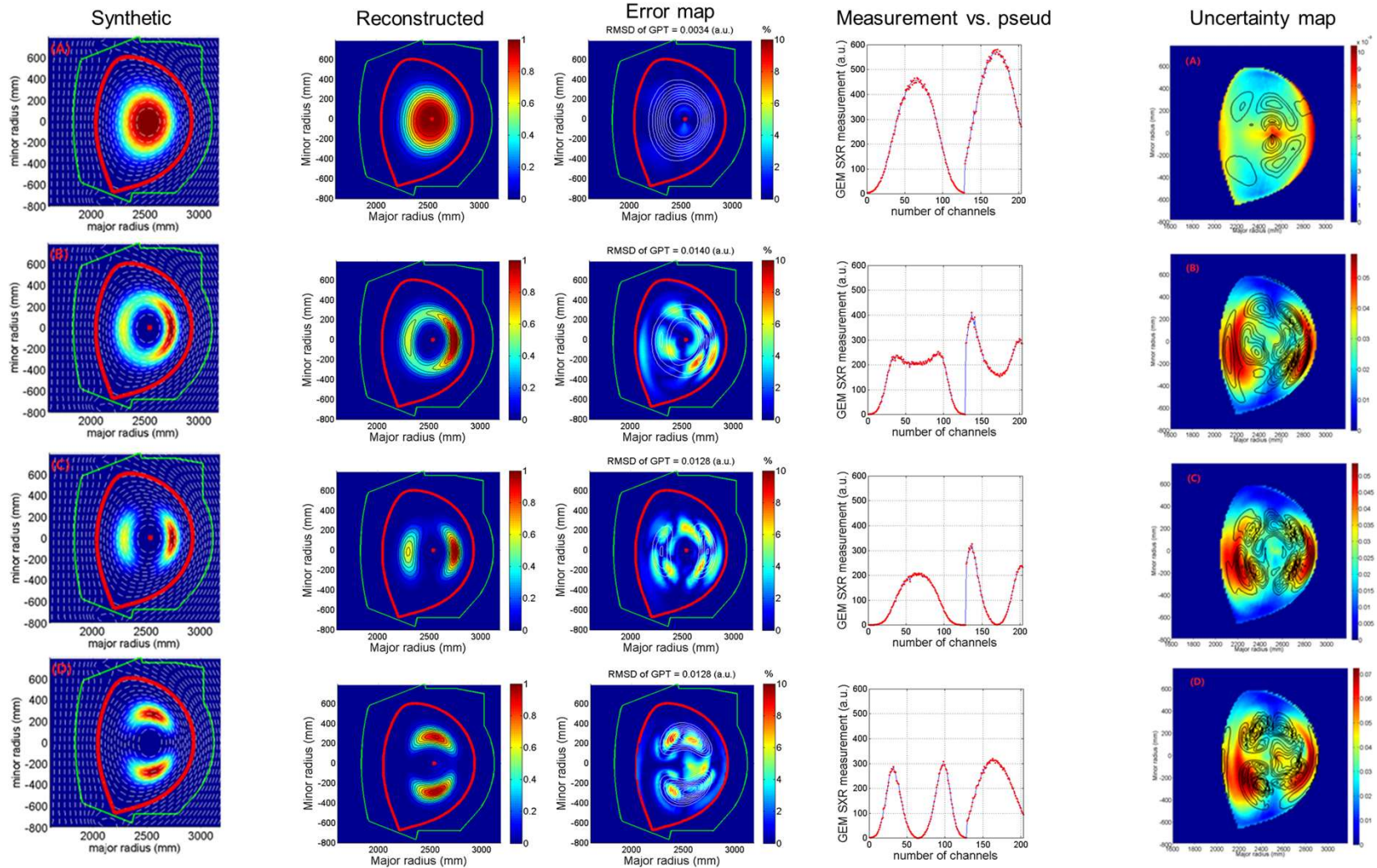

T. Wang, D. Mazon, J. Svensson, D. Li, A. Jardin and G. Verdoolaeg. *Gaussian Process tomography for soft X-ray spectroscopy at WEST without equilibrium information.* *Rev Sci Instrum.* 2018 Jun. 89(6).

- ▶ some recent applications on Tore Supra / WEST (e.g. tomography example, interaction with fast electrons, HXR/SXR integrated approach...)

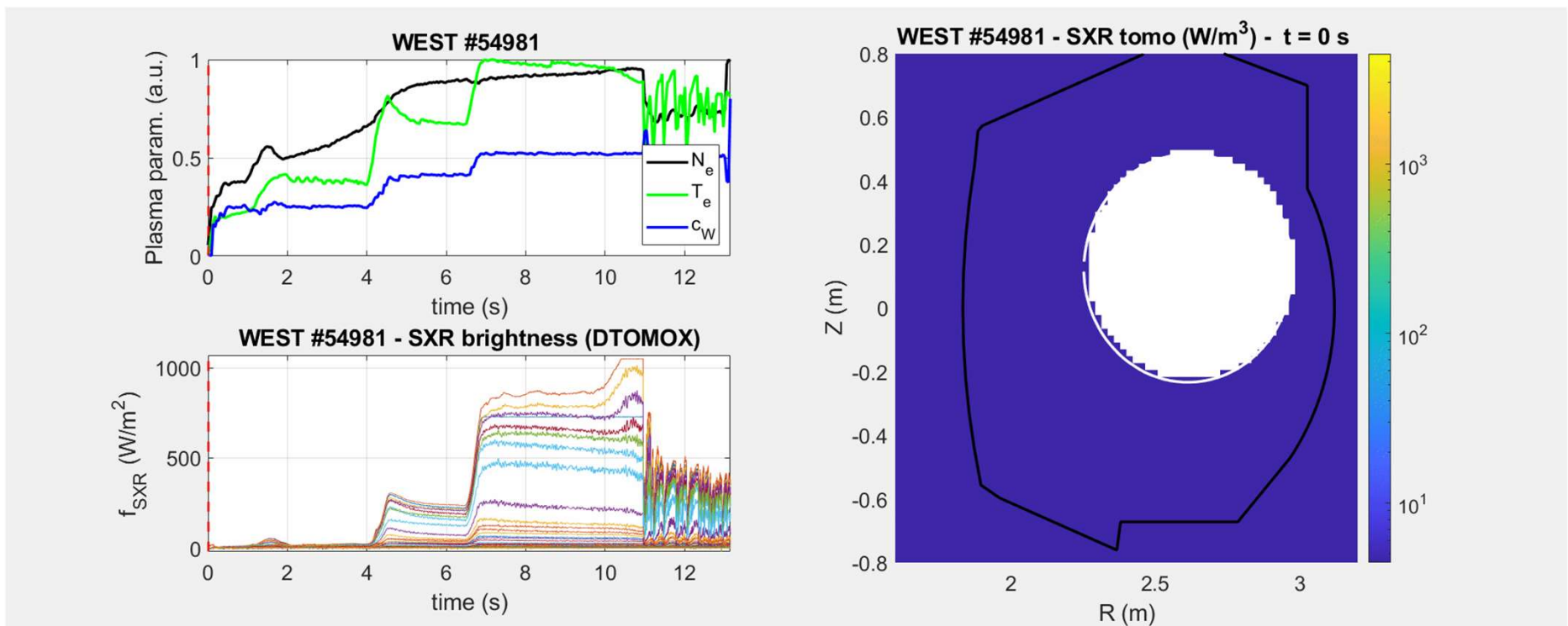

[D. Mazon et al, JINST 17 C01073 (2022)]

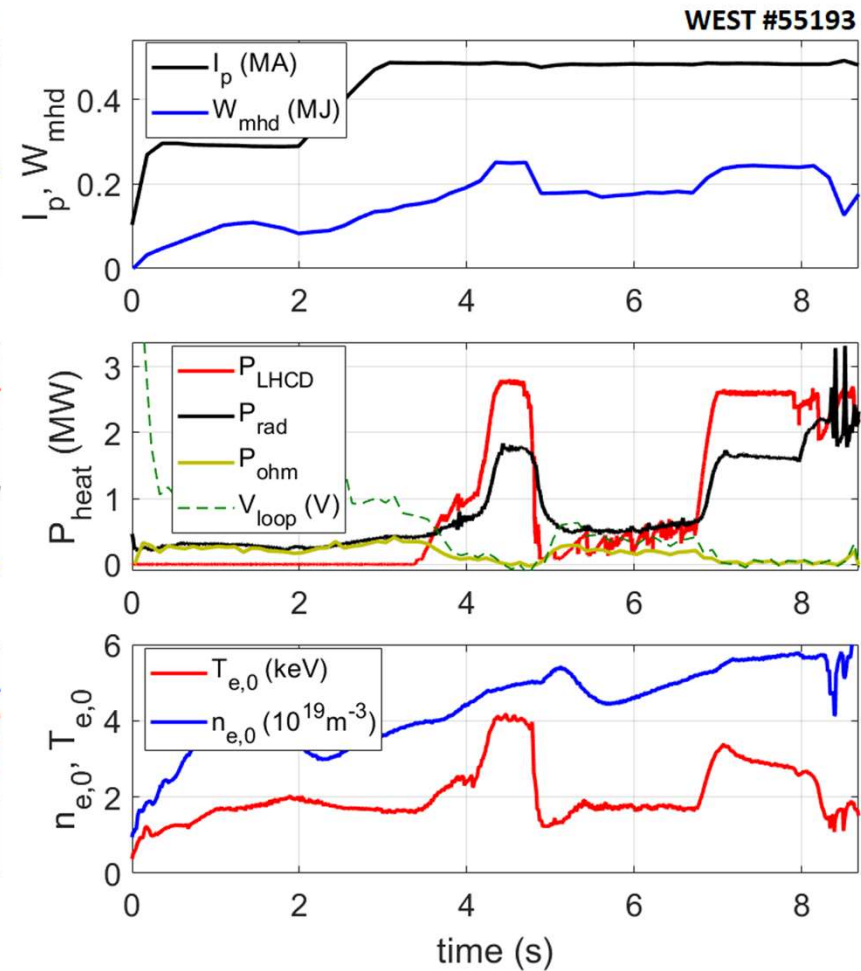
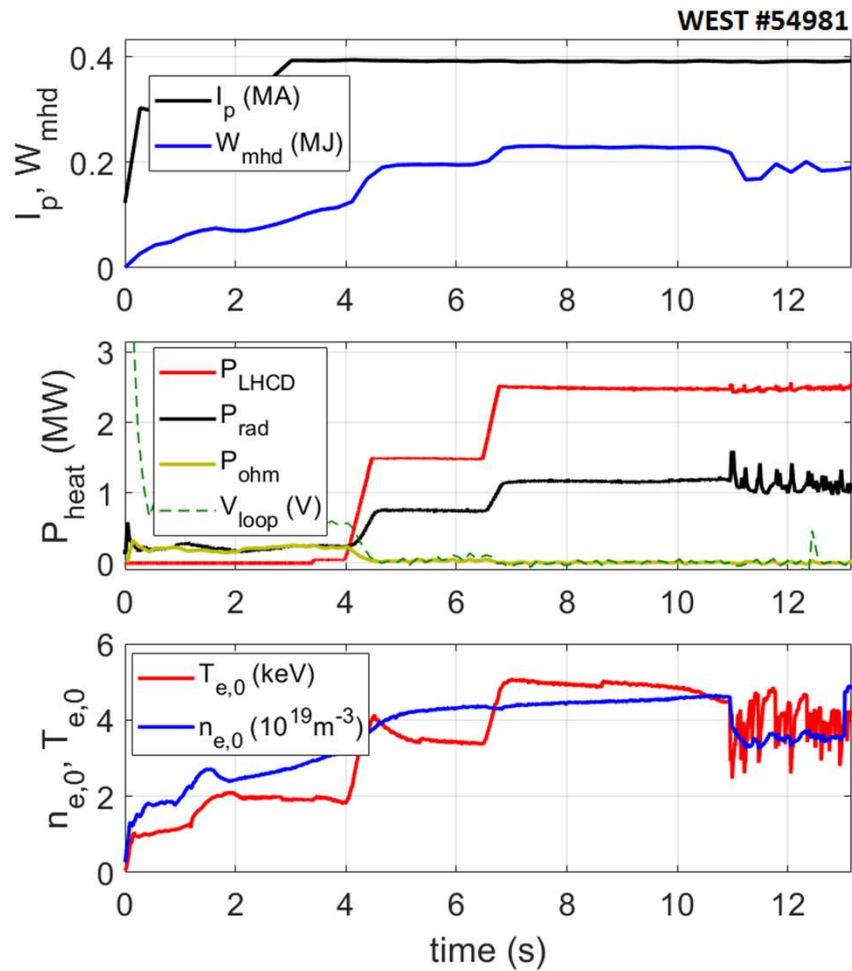

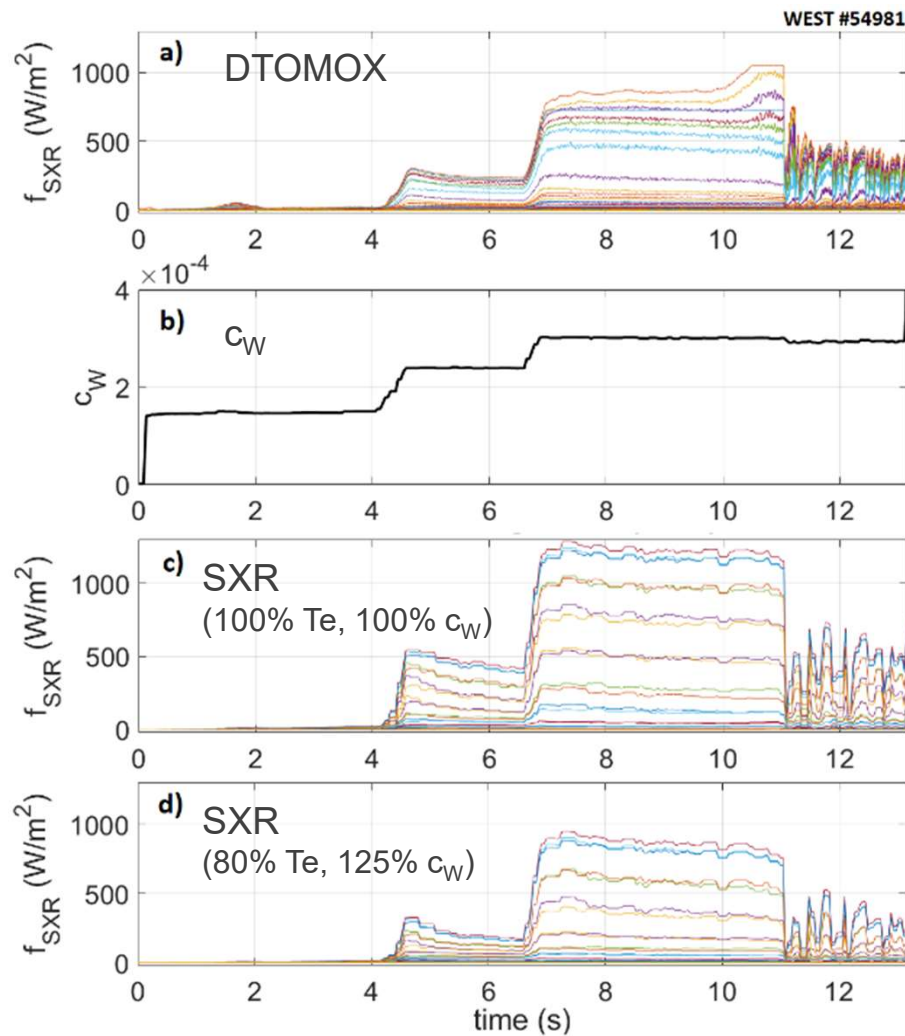

[D. Mazon et al, JINST 17 C01073 (2022)]

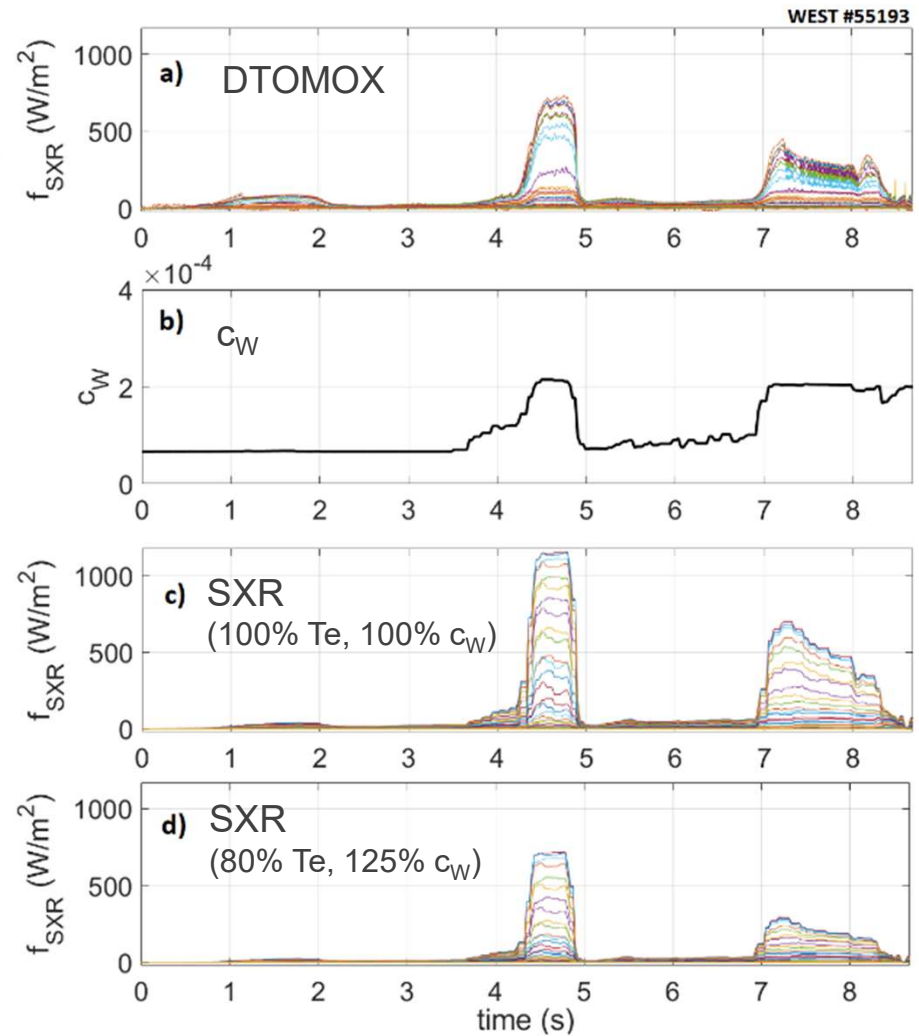





□ HXR and SXR modeling give consistent results:

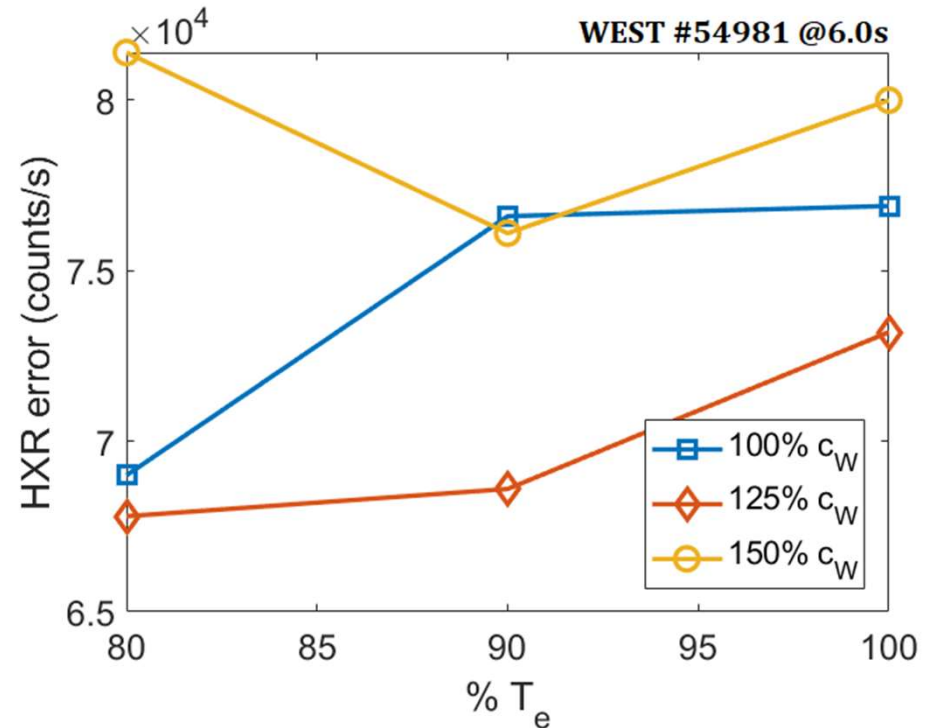
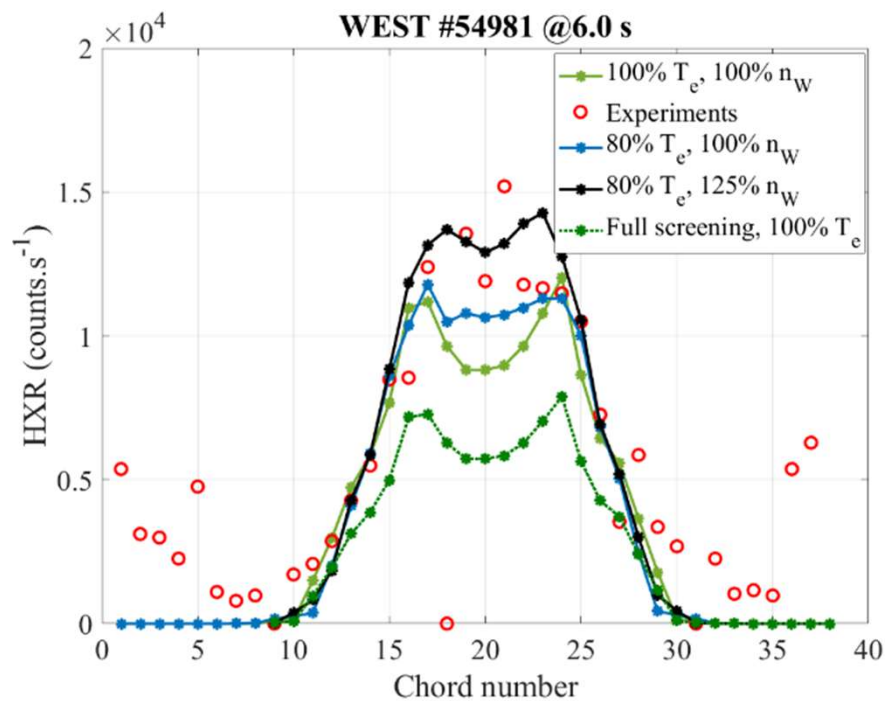
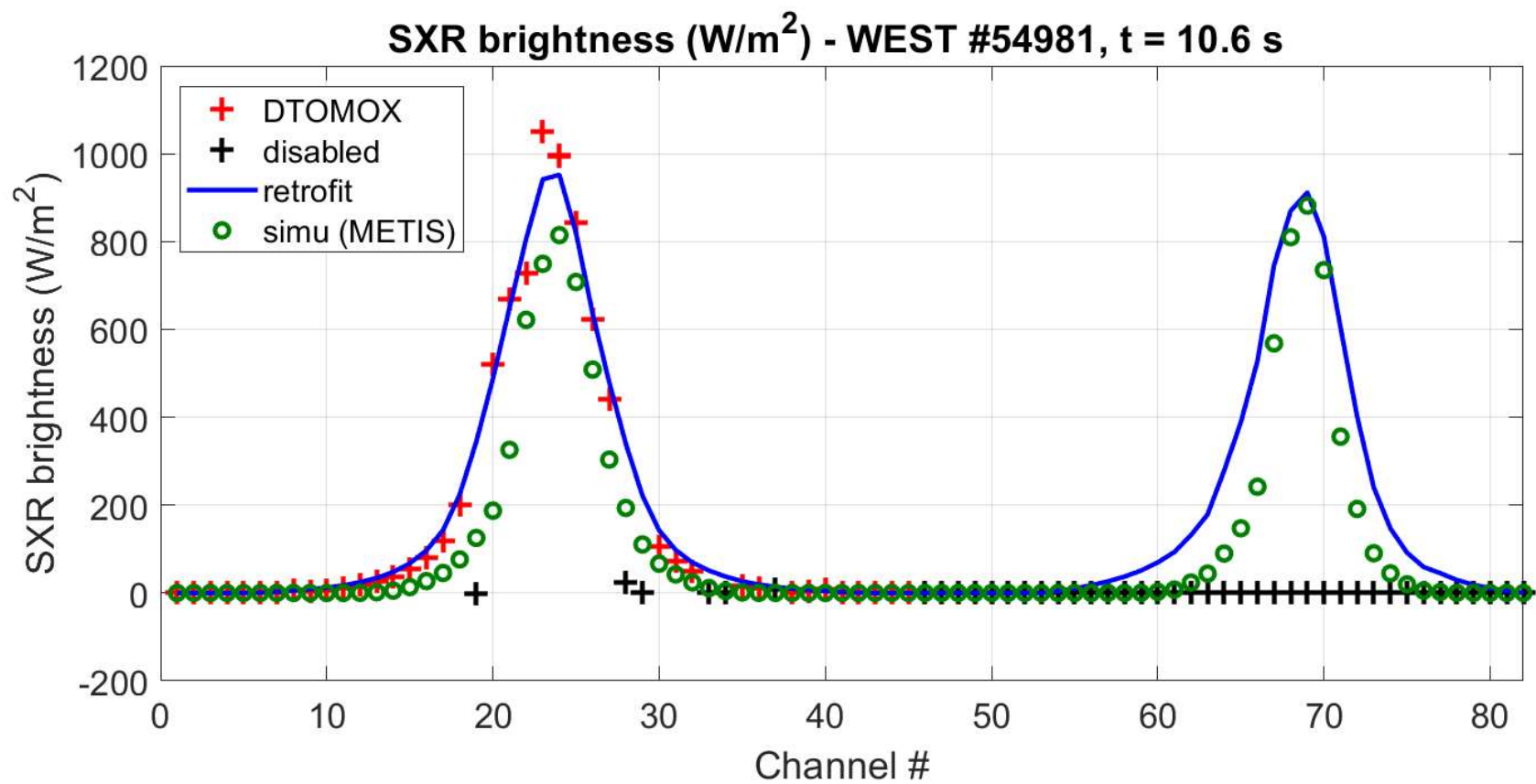

**Figure.** Modelling using METIS LUKE R5X2 suite of codes of HXR measurements in the energy range 60-80 keV for WEST #54981 at 6.0 s. Left: comparison Full screening/partial screening and influence of  $T_e$  and W concentration. Right: Influence of the electron temperature and W concentration on the discrepancy between R5X2 and HXR measurements.

[D. Mazon et al, JINST 17 C01073 (2022)]

- Several detectors type can deliver proper information from SXR spectrum (Gas detectors)
- Tomographic optimisation is always needed, including magnetic equilibrium
- Not easy anyway to deduce the Cw due principally to the cooling factor dependence on Te
- HXR/SXR/Modelling integrated approach seems promising

Thanks for your attention!

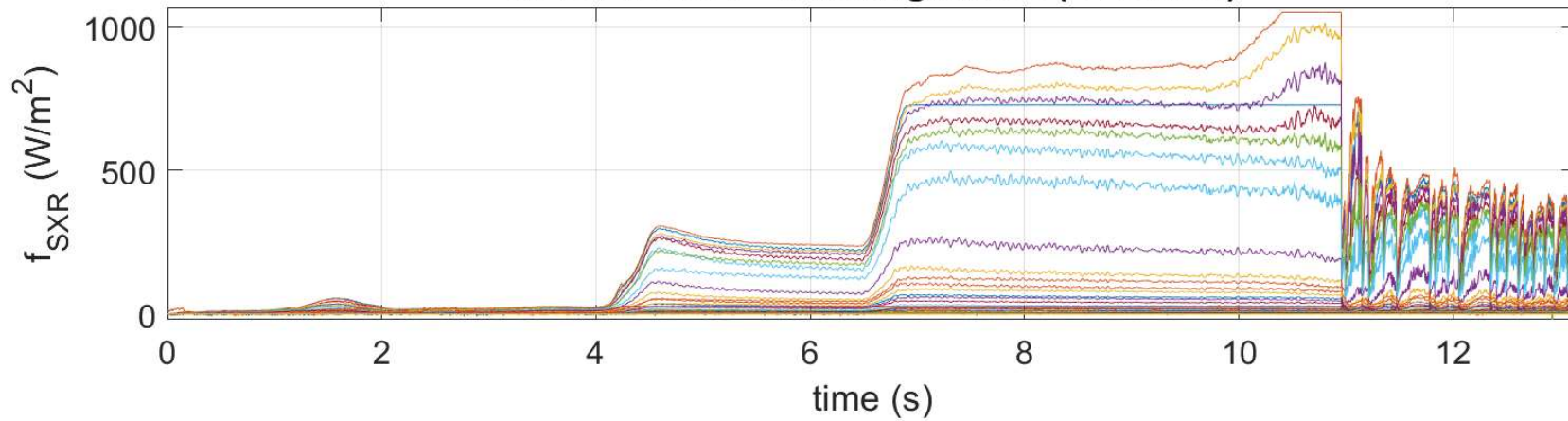

**WEST #54981 - SXR brightness (DTOMOX)****WEST #54981 - SXR brightness (simu)**