

SEMI-VIRTUAL DYNAMIC TESTS OF HYBRID SYSTEMS COUPLING SOLAR THERMAL AND PV PANELS WITH HEAT PUMPS

David Chèze¹, Antoine Leconte¹

¹ Univ. Grenoble Alpes, CEA, Liten, Campus Ines, Le Bourget du Lac (France)

Abstract

Considering the huge world's energy demand associated with heating and cooling (H&C), the share of installed renewable H&C solutions was still around 10% in 2018. In order to speed up a transition towards the widespread application of renewable H&C in buildings, innovative solutions must be designed to outperform traditional solutions by saving non-renewable energy. SunHorizon project is contributing to this effort by demonstrating optimized design and combination of commercial innovative solar (thermal or/and PV) and Heat Pumps (HP) technologies. In particular this paper aims to demonstrate how to evaluate experimentally two hybrid concepts, out of four in the whole project, that are coupling solar thermal and PV panels with heat pumps to satisfy thermal and electricity energy demand of residential buildings in Riga (Latvia) and Piera (Spain). Relying on the hardware-in-the-loop approach called TYPSS, specific short test sequences are created for each of the two Technology Packages (TP) that allow for extrapolation of the measurements to annual seasonal performance figures including electricity self-consumption, renewable heating and cooling indicators. Both hybrid systems reached experimentally 40% renewable energy ratios.

Keywords: performance test, hardware-in-the-loop, solar thermal, PV, PVT, heat pump, electricity self-consumption, renewable energy, building.

1. Introduction

Regarding the challenge of renewable energy integration for buildings H&C that is still around 5% of world's final energy use (REN21, 2021), the SunHorizon project proposal is to demonstrate innovative and reliable HP solutions (thermal compression, adsorption, reversible), properly coupled and managed with advanced solar panels (thermal, PVT, PV), to provide H&C to residential and tertiary building with lower emissions, energy bills and fossil fuel dependency. Four different TPs are being developed and demonstrated all across EU climates (i.e. Germany, Spain, Belgium and Latvia) and building typologies (small and large-scale residential and tertiary buildings).

In this work, the wide SunHorizon scope above is restricted on two approaches, Hybrid System #1 (HS1) and Hybrid System #2 (HS2), which generate solar heat and electricity to save non-renewable energy consumption in residential context. HS1 can meet both heating and cooling demands rather in Mediterranean areas and will be operated in-situ in Piera (Spain). HS2 is focused on areas with predominating heating demand and will be installed and run in-situ in Riga (Latvia) from August 2021. The Sunhorizon objective is here to validate the technologies integration into HS1 and HS2 concept through the semi-virtual testing approach, essentially control aspects, with respect to the relevant operating conditions to be met afterwards on the real demo sites. The main new challenge of the test sequence elaboration compared to previous works context in Chèze et al. (2018) and Lamaison et al. (2021) is to address the challenging transition between heating and cooling seasons on the one hand, and the electricity balance between PV production and both system and building consumptions on the other hand while achieving satisfactory compromise between shortest sequences and estimation accuracy of extrapolated results regarding the annual simulation results.

The next section gives a description of the two different hybrid systems including the operation principle and the sizes of the components. Then the following section highlights the challenges for dynamic test bench when dealing with such hybrid systems and introduces the TYPSS methodology to elaborate customized test sequences.

Finally the results of the tests are presented for each hybrid system.

2. Hybrid systems

The challenges around hybrid systems definition and dynamic testing are relying on the diversity of system configurations and destinations. Indeed several technologies are available to use solar radiation for heat and electricity productions, as several type of heat pump, air-to-water or brine-to-water. In this work, we are relying on two examples from the SunHorizon project to illustrate this topic. A preliminary TRNSYS simulation work (Chèze et al., 2020) led to the design and sizing of HS2 and HS1 concepts and it's been used to develop the related dynamic system test conditions in the next section.

The HS1 concept illustrated in Fig. 1 is built from BDR Thermea products: separated 4 m² solar thermal flat plate and 10 m² PV panels with harmonized roof integration, air source reversible 6kW COP=3.4 at A2/W35 heat pump, 300/140L buffer/DHW tank, and global controller managing heating/cooling and PV electricity balance at system and building level. The specific goal of this controller is to maximize PV self-consumption. To do so, the HP operation is forced when PV power is available. This way, PV power is stored as heat in DHW and buffer tank. The system is integrated in simulation in Piera (Spain) demonstration context: 110m² residential house with 2 people living in, 5.4 MWh space heating (SH) and 1.2 MWh space cooling (SC) demand supplied by radiators and fan coils separate circuits, 1.2 MWh domestic hot water (DHW) demand, 2.3 MWh electricity consumption. The estimation of the fractional Green House Gas savings ($fsav_{GHG}$) is 53% for HS1 in Piera compared to existing oil boiler and 4m² solar DHW heating system, also considering extra comfort gain through new cooling supply.

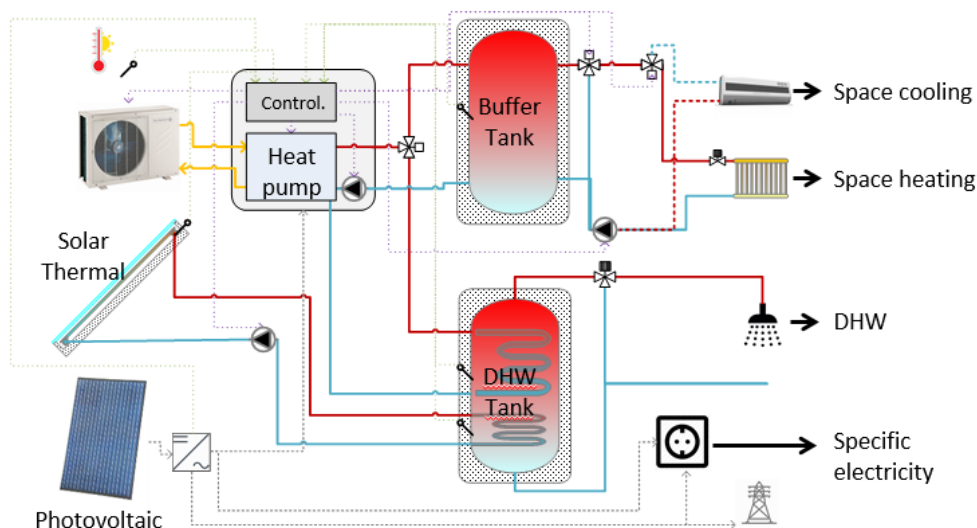

Fig. 1: Hybrid system HS1, solar thermal integration in parallel to heat pump thermal supply

The HS2 concept relies on 50m² Dualsun solar PVT panels, Boostheat 20kW thermal compression gas fired CO₂ heat pump with Gas Utilization Efficiency GUE=2.0 at A7/W35, 0.2/1.3 m³ cold/hot thermal storage tanks and 15kW SMart Electric heater (SmE) from PV electricity excess by Ratiotherm. The heat from hybrid PVT panels flows either to cold glycol tank or hot buffer tank, according to the coldest tank. The Boostheat unit is activated complementary to grant the supply of SH and DHW at the desired temperature. The evaporator is connected to the hottest heat source from outdoor air coil or mitigated glycol tank. The extra PV electricity produced by the hybrid PVT panels compared to building electricity balance is stored as heat into the buffer tank until 85°C temperature is achieved, then fed into the grid. The complexity is increased in this case by mixing components and controls from several manufacturers into new concept assembly for several demo sites and by mixing non-renewable gas and electricity consumptions to operate them. The HS2 system was integrated in simulation in Riga (Latvia) demonstration context: 108 m² residential house with 3 people living in, 13.3 MWh SH supplied by radiators and heating floor circuits, 1.6 MWh DHW, electricity consumption 7.2 MWh. The estimation of annual

GreenHouse Gas emissions savings (fsav,GHG) through HS2 is 51% compared to the existing gas boiler.

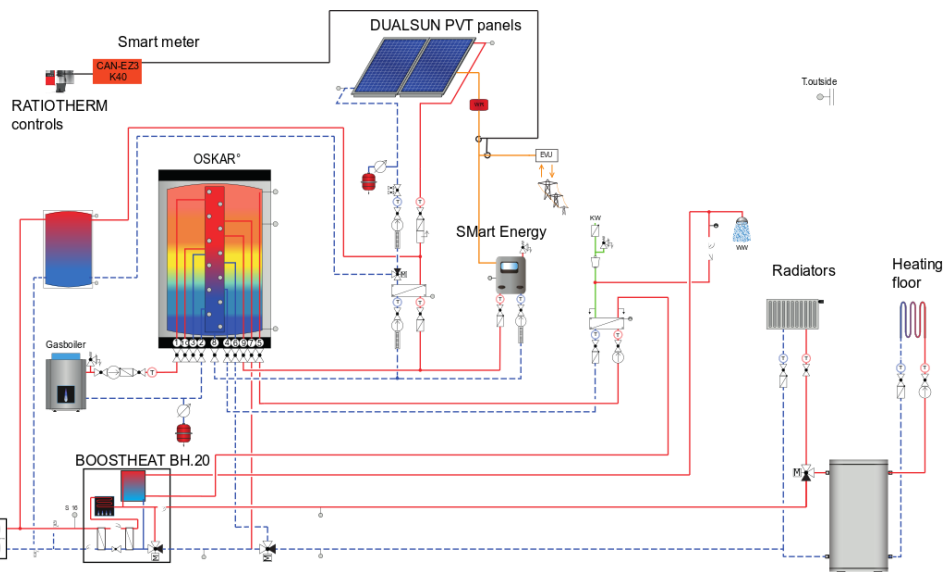

Fig. 2: Hybrid system HS2, solar thermal integration in series/parallel heat pump thermal supply

3. Semi-virtual test of hybrid systems

3.1 Test bench integration

An illustration of the architecture of HS1 integrated in dynamic thermal system test bench laboratory is presented in Fig. 3, together with a picture of the indoor system parts. The specific part for this Hybrid system test is that the PV inverter was also simulated to send specific signals to the global controller, to maximize the PV self-consumption.

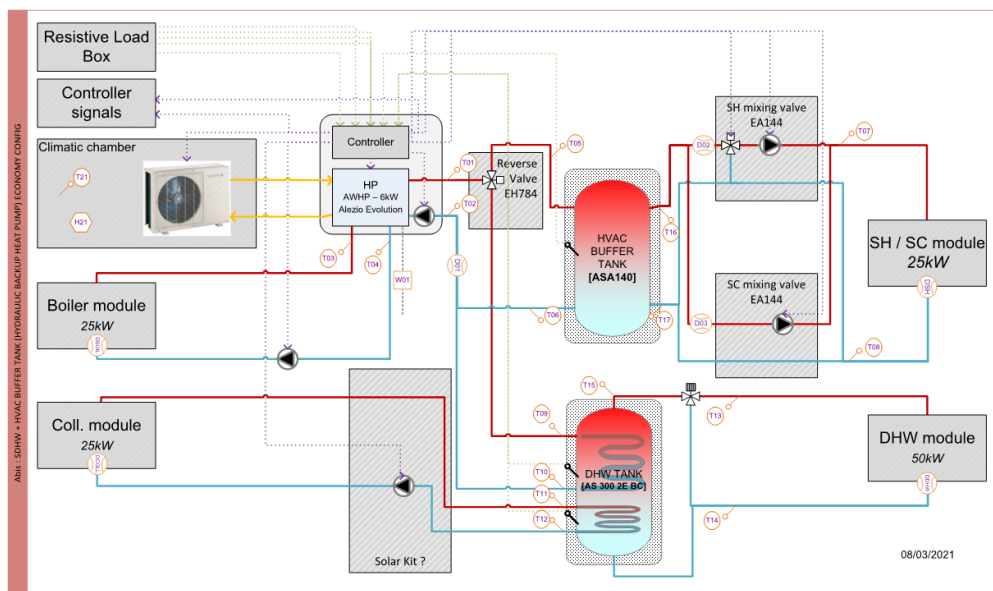



Fig. 3: HS1 concept and outlook of real prototype integrated in semi-virtual test bench

The Fig. 4 is showing similar integration of HS2 into the semi-virtual test bench (pink) for the DHW module, separate radiators and heating floor SH modules, solar thermal hydraulic module, emulation of resistive temperature sensors of the virtual panels, indoor living room or outdoor air, or the outdoor air conditioning around HP's outdoor unit in the climatic chamber. Especially for the smart meter emulation regarding the management of virtual PV electricity instantaneous production (W_{pv} , dynamic variations influenced by HS2 real operating conditions), we need to calculate in eq. 1 the whole virtual building electricity balance ($W_{gridbal}$) in real-time (10s refreshing period) including the real system dynamic electricity consumptions (TIVA1, TIVA2, TIVA4) in addition to the building electricity consumption profile ($W_{elbuild}$) from the test sequence. The MODBUS TCP communication with Ratiotherm's controls allowed to emulate the $W_{gridbal}$ value required to control the Sme self-consumption of PV excess and to log some controller's internal sensors and states for iterative controller's improvements.

$$W_{gridbal} = W_{pv} - W_{elbuild} - TIVA1 - TIVA2 - TIVA4 \quad (\text{eq. 1})$$

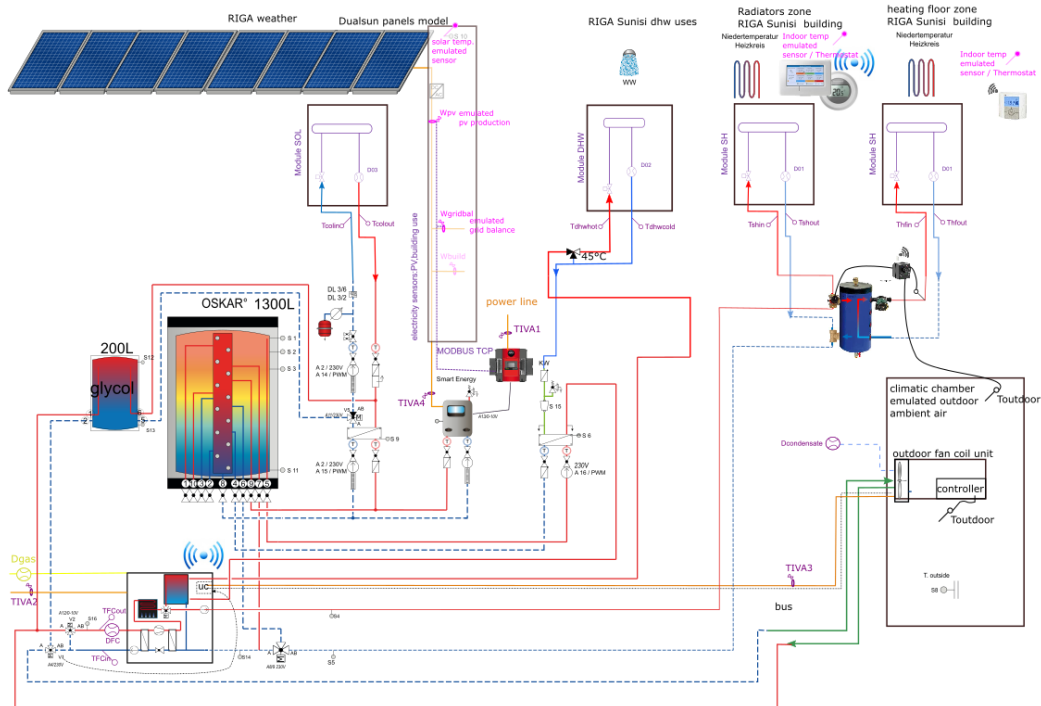



Fig. 4: HS2 concept and outlook of real prototype integrated in semi-virtual test bench

3.2 TYPSS methodology

The semi-virtual test is a global system test approach considering the real-time strong interactions between the building, the local energy systems and controllers, the environment and the users. In his PhD thesis work, (Sayegh, 2020) developed a new approach and automated tool called TYPSS (for TYPical Short Sequence selection). This generic methodology creates a short climate sequence from a dynamic model that reproduces the behaviour and the global performances of a system. The methodology is here applied to create the test sequence to be applied in real-time on the test bench to estimate the annual performances of the tested systems. This approach came after previous works following similar philosophy around the elaboration of short sequence test for dynamic thermal system test as in Albaric et al. (2010), Chèze et al. (2018), Menegon et al. (2020).

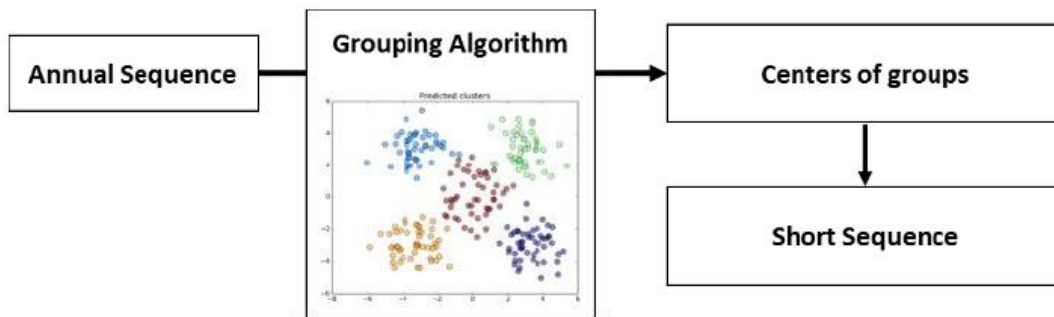

Fig. 5: Grouping method in typical day selection TIPSS

As illustrated in Fig. 5 and Fig. 6, the algorithm simulates a dynamic model similar to the target system with the short sequence, extrapolates and compares the outcomes with annual simulation criteria, subdivides the worst performing period (Different weight for each day of the sequence depending on the represented period length) until it finds the most appropriate day to represent each period. It iterates until each criterion is well estimated with the appropriate number of days for the sequence.

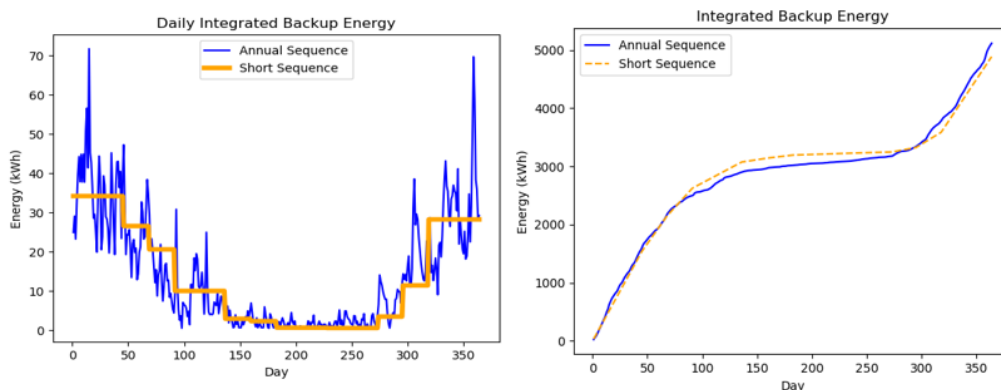

Fig. 6: Example of daily (left) and integrated (right) results for Backup Energy

In the SunHorizon work, the TYPSS tool was applied to the TRNSYS models of HS1 and HS2 to elaborate short test sequences that are relevant with respect to the two different demonstration sites and environments.

3.3 Application to Hybrid Systems

For the elaboration of HS1 short sequence, we selected the following six criteria as targets for the annual extrapolation process and we limited the target sequence duration to 10 days: WHP: HP electrical consumption, QDHW: DHW demand, QSH: SH demand, QSC: SC demand, WPV: PV electricity production, TBufTank: temperature of the buffer tank (H&C), referred in Tab. 1 and Tab. 2.

Fig. 7 illustrates two criteria involved in the TYPSS methodology to design a short sequence representative of one-year operation for HS1: the HP electricity consumption on the left hand-side (green), the average temperature of the buffer tank on the right hand side (blue). The evolution of both criterion for the annual sequence (solid line) and the TYPSS sequence (dashed line) is represented: daily values on the left part, cumulative values on the right side. One can see that the transition between the heating and the cooling season is well represented. The buffer tank is cooled during the appropriate period of the sequence and it represents an appropriate increase in the HP consumption during the summer period. With regard to the short 10-days sequence challenge, one can notice on Tab. 2 that the deviation of every criteria doesn't exceed 6% except for the cooling load. It was decided an acceptable trade-off considering the short sequence duration requirement and higher priority given to the overall electricity consumption of the system.

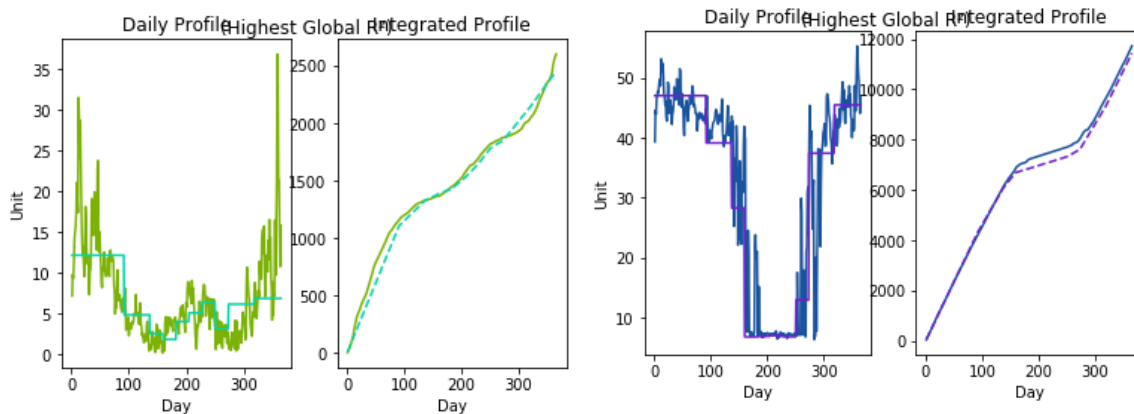

Fig. 7: HS1 annual/10-days sequence comparison of HP electricity profile (left) and the buffer tank average temperature (right)

The Fig. 7 is showing relevant simulated HS1's dynamic behaviour looking at the daily consumption of the HP and the average temperature of the buffer tank indicator of the HC season. In the Tab. 1, annual key performance indicators (KPI) are well estimated by the extrapolated short sequence simulation results. The KPIs' definitions and assumptions regarding energy baselines of the existing system, country's primary energy coefficients and GHG emissions per energy carrier are detailed in SunHorizon public reports D6.1 (CEA et al., 2020).

Tab. 1: comparison between annual and extrapolated short sequence indicators for HS1

Indicators	Annual sim.	Annual extrap. sim.
QSH - SH demand [kWh]	5442	5712
QSC - SC demand [kWh]	1105	1278
WHP - HP electrical consumption [kWh]	2342	2441
Fsav,PE - Primary Energy savings [%]	59%	62%
RER - Renewable Energy Ratio [%]	42%	45%

Since no cooling demand in the HS2 case compared to HS1 case, we assumed that we need less criteria to represent the annual profile and we limited to three criteria and 9 days in the HS2 test sequence elaboration: the average flow temperature in heating floor and radiators ($^{\circ}\text{C}$, criterion 1, T_{flow}), building electricity balance (KWh, criterion 2, W_{gridbal}) and the gas consumption (KWh, criterion 3, Q_{gas}) presented in Fig. 8. In bottom-right view it shows a few profiles of the resulting 9-days sequence that still mimic an annual variations of outdoor air ($-9/20^{\circ}\text{C}$), solar radiation (800 W/m^2 max) and building electricity demand ($0.1/3.5\text{ kW}$).

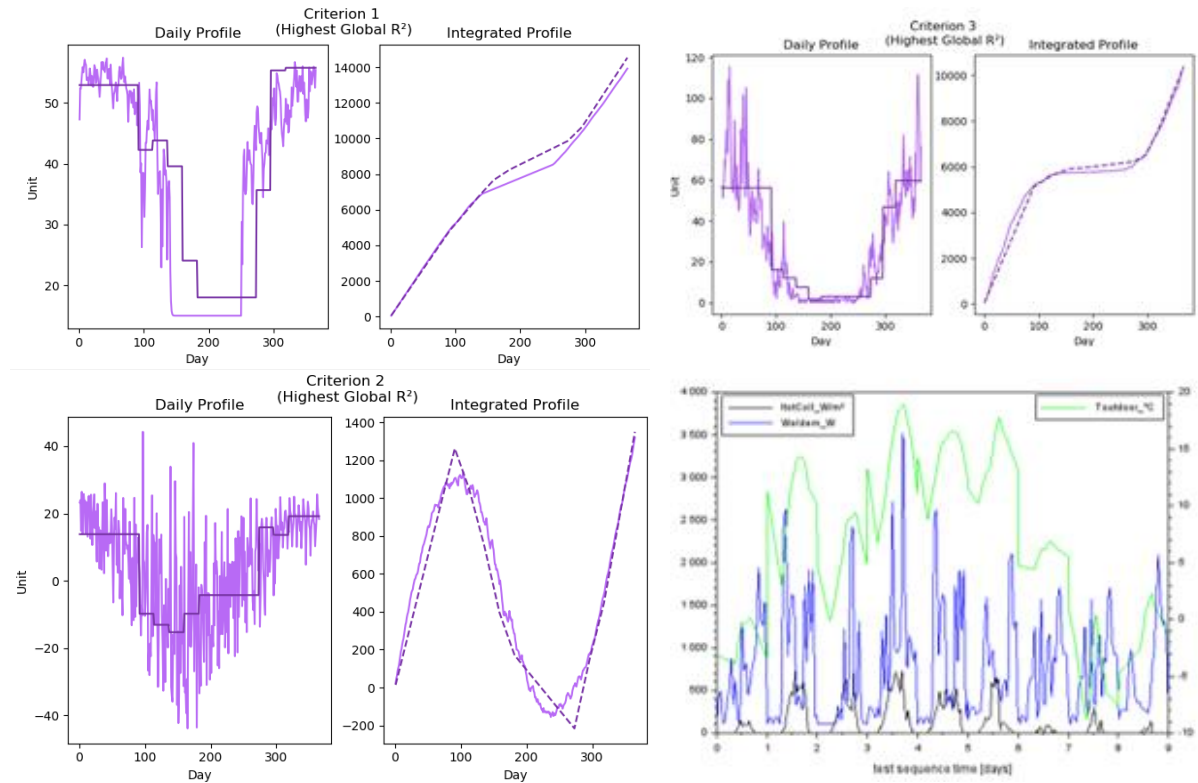

Fig. 8: HS2 comparison of annual/9-days sequence profile (left) and integration (right) – 9-days sequence outlook (bottom-right)

The Tab. 2 is summarizing the criteria's prediction accuracy for both HS1 and HS2 short sequences. The R^2 coefficients of determination close to 1 are showing good agreement of the short sequences' profiles with regard to the annual ones.

Tab. 2: various criteria selection for the design of HS1 and HS2 short sequences

Test sequence	Duration	WHP	WPV	Wgrid bal	Qgas	Tflow	TBuf Tank	QDHW	QSH	QSC
HS1	10 days	$R^2=0.98$, cumul. 5.7%	$R^2=0.99$, cumul. 4.1%				$R^2=0.99$, cumul. 2.5%	$R^2=0.92$, cumul. 1.6%	$R^2=0.94$, cumul. 0.6%	$R^2=0.97$, cumul. 12.0%
HS2	9 days			$R^2=0.98$, cumul. 4.4%	$R^2=0.95$, cumul. 2.3%	$R^2=0.98$, cumul. 1.0%				

4. Test results analysis

4.1 Detailed timeseries analysis

The 10-days HS1 short sequence generated by TYPSS ran on the HS1 prototype installed on the semi-virtual test bench. In addition to the global performance criteria estimations presented in next section, such test can bring valuable in-sights of the real system behaviour compared to pure numerical studies since it implies real component interactions and real system operation.

For instance, in Fig. 9 showing the temperature in the virtual building's kitchen, in the SH and SC loop, in the Buffer tank and in the DHW tank during HS1 tests, it reveals the effect on various monitored variables of the different HS1 system's settings, named SEQ1 and SEQ2 where the PV self-consumption threshold was modified. This is useful for the manufacturer to learn how to tune the prototype and elaborate applications guidelines since wrong setups of such complex hydraulic and controllers of hybrid system could underperform. The comprehensive monitoring of the tested system provides precious operation details for further improvements. The temperatures, thermal and power transfers can be compared to the simulations to check if the system is working as expected. Finally, running several test sequences SEQ1 and SEQ2 allowed to compare the influence of different controller settings.

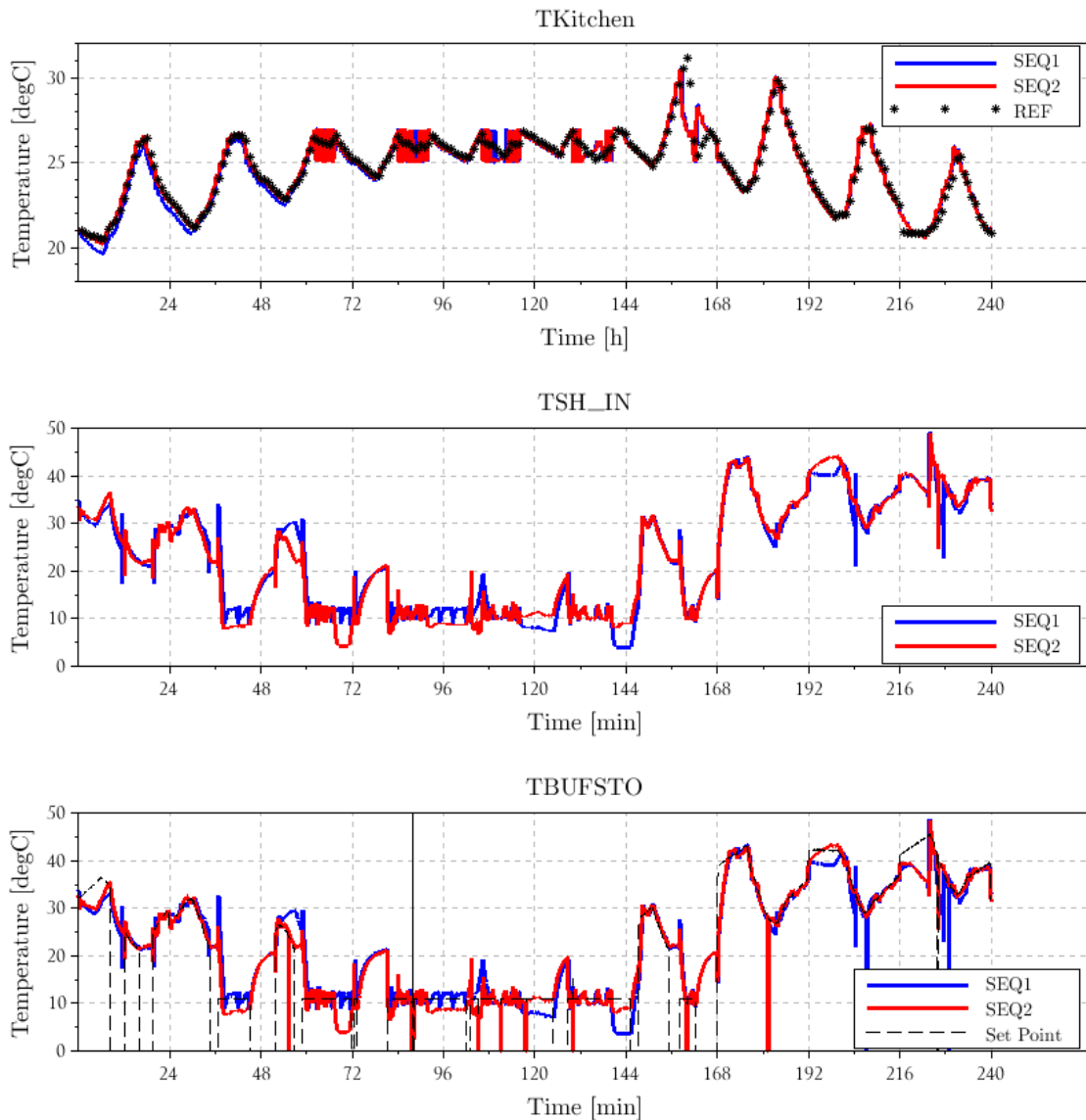

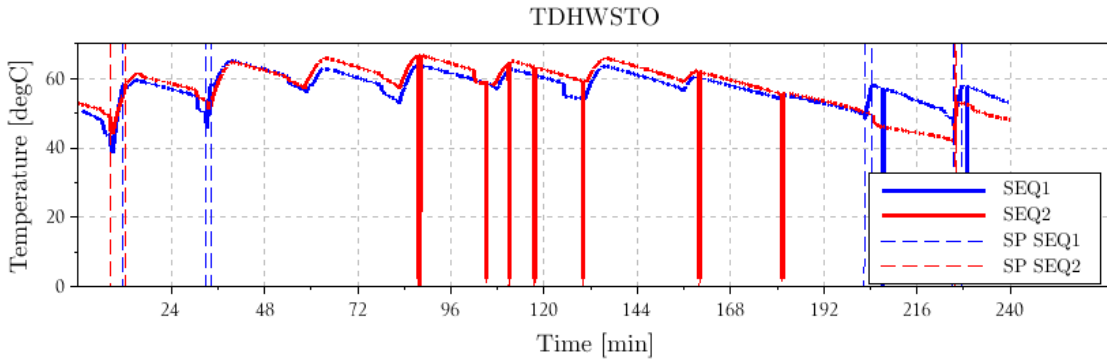

Fig. 9: HS1 results, detailed view analysis of self-consumption behavior

Now looking at timeseries from the test run of HS2 in Fig. 10, we are able to perform various global or detailed analysis. Since the real system's component configuration from industrial partners differs from the component configuration assumed in simplified simulation model, one can track potential for improvements from the detailed timeseries by comparing the measurements with simulated behaviour. These improvements are often in the field of control.

On the top view we notice the 24h-conditioning time to let the system reach an average thermal state in heating season: it's done by running the last day of the test sequence before monitoring performance from day 1 to 9 which is from time 0 to 216 h. It is showing as well that the room temperature comfort is achieved (23.5°C set point was assumed from the baseline study in previous steps of the project), and we notice also the solar passive gains (room temperature increase while heating circuit stopped and solar radiation) revealing good performance of building's envelope.

This test also revealed the self-consumption dynamic behaviour, following the simulated PV electricity production. One notices an average power feed-in into the grid about 500W in this situation. This test allow to detect a hardware component failure in electric heater, revealed by the oscillations of electricity balance signal. It revealed also the 3kW modulation limit of the thermal compression heat pump, which is oversized regarding the heat demand of Riga's building.

In this test we were able to compare of solar thermal production of the real tested system with the simulated system: it was expected that solar heat is produced and flows into the glycol tank and evaporator (as the coldest temperature): the test revealed it was not the case for the actual tested system, meaning significant deviation between the real system and simulation model.

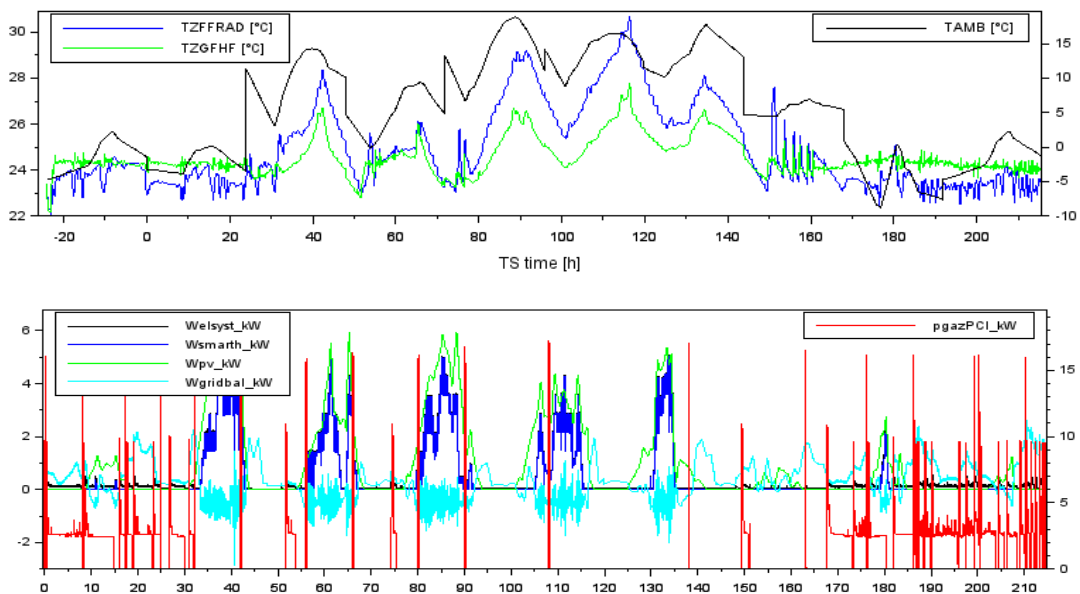

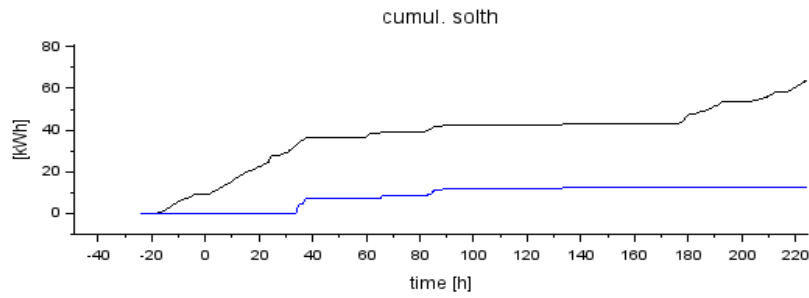

Fig. 10: HS2 results, detailed view analysis along 9-days sequence

4.2 Annual extrapolation

Another perspective on the results offered by the TYPSS methodology is the extrapolation of the daily cumulated indicators to annual indicators with weighting factors from the test sequence elaboration.

For HS1, the Fig. 11 reveals rather good agreement for most of the indicators. As there was not room thermostat control, we noticed more thermal load, heating and cooling, that caused more HP electricity consumption.

From SunHorizon project perspective, the Tab.3 is presenting some of the calculated KPIs for both simulated and tested system. For the latter case, KPI are based on the extrapolated energy balance (including the Non Renewable Primary Energy consumption, PE_{ren}) which is compared to the same baseline primary energy consumption (PE_{ren}), including all building's thermal and electricity demands. The primary energy savings ($F_{sav,PE}$) reaches nearly 50%, GHG savings ($F_{sav,GHG}$) 43%, 40% of building energy demand comes from renewable energy (RER: Renewable Energy Ratio) and 66% electricity self-consumption (SCR: Self Consumption Ratio).

From the observed deviation between simulation and tested system, the next step would be to refine the modelling of HP's control to let both simulated and real prototype converge towards each other and reach increased savings.

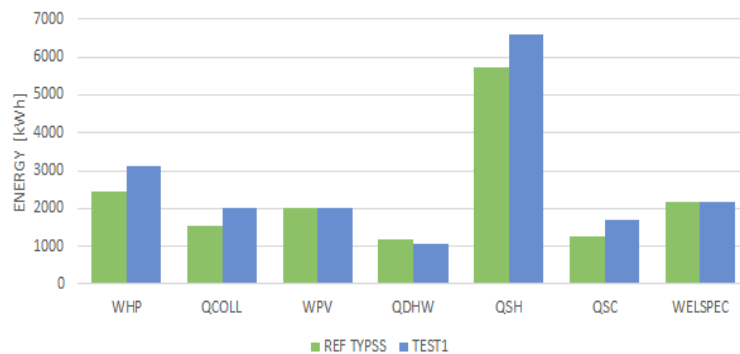

Fig. 11: HS1 real/model comparison of extrapolated annual energy deviations

Tab. 3: HS1 real/model comparison of extrapolated annual KPIs

	PE_{ren} baseline MWh	PE_{ren} MWh	F_{sav,PE}	F_{sav,GHG}	RER	SCR
SIM	14.1	5.2	62%	56%	43%	41%
TEST		7.4	49%	43%	40%	66%

In the Fig. 12 for HS2 test, we notice again that the solar thermal heat production and evaporator loop are very low which caused increased gas consumption as previously detected in Fig. 10. It requires parameter settings adjustment to match the separate controllers' logics of solar loop and heat pump's loop (coming from two different manufacturers). We may also notice significant heating floor overheating that is possible since it is not controlled with room thermostat compared to the radiator area.

The Tab. 4 is showing significant primary energy and GHG savings but large deviations with expected values which requires further developments as more integrated controls to improve the solar thermal use at HP's evaporator.

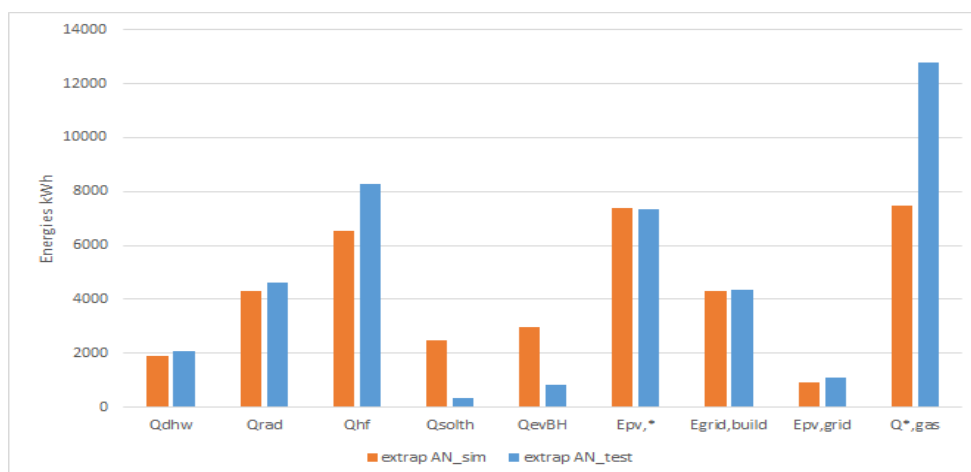

Fig. 12: HS2 real/model comparison of extrapolated annual energy deviations

Tab. 4: HS2 real/model comparison of extrapolated annual KPIs

	PE_{ren} baseline MWh	PE_{ren} MWh	F_{sav,PE}	F_{sav,GHG}	RER	SCR
SIM	27.9	13.3	52%	54%	56%	88%
TEST		18.9	32%	41%	43%	85%

Looking at the two different systems and contexts, we notice that HS1 achieve highest PE/GHG relative savings scores that can use full potential renewable electricity from PV in cooling season vs. mixed gas and electricity HS2 case whenever it can rely on higher solar areas and thermal storage. On the other hand, HS2 that is mixing gas and electricity grid supply, with the flexible integrated smart electric heater and larger power-to-heat thermal storage manages highest PV electricity self-consumption score. We should refrain from direct comparison between HS1 and HS2 results since different energy baseline, different solar collector field's and heat pump's sizes and types, different climates and building demands, different country primary energy factors.

5. Conclusion

As a conclusion, thanks to the TYPSS methodology and tool, this work managed to develop a custom short test sequence for each system and demonstration environment, as customized building type, climate and users behaviours (DHW and specific electricity consumption). The test sequences allowed the extrapolation of the measurements during either the 10-days or 9-days tests to annual performance figures. The semi-virtual tests of real HS1 and real HS2, first prototype assemblies, with the TYPSS short test sequence proved for both more than 40% GHG savings coming from more than 40% renewable energy. It means that such hybrid systems can actually support increasing the current 10% renewable energy in H&C energy demand (REN21, 2021). The execution of both HS2 and HS1 tests revealed some tricky issues around the configuration of the controllers to achieve expected behaviours, like the PV self-consumption threshold setting for HS1. In particular for the HS2 system which is combining the components and controllers from two manufacturers, Ratiotherm and Boostheat, it revealed limitations around the integration of solar heat from PVT panels at the evaporator of the CO₂ heat pump and thus significant potential of performance improvement through further development. In addition, we noticed that the global performance of such real hybrid solar systems, alike for other traditional thermal systems, is overestimated if the heat pump is oversized with regard to recent high performance building even in cold climate. This testing experience allows issuing recommendations for the future reliable installations on-site in October 2021. The TYPSS methodology was demonstrated to be flexible to deal with the characterization of hybrid solar thermal and PV system and could address successfully the evaluation of other hybrid systems structure with batteries and Energy Management System (EMS) for instance.

6. Acknowledgments

The SunHorizon project has received funding from the European Union's Horizon 2020 Research and Innovation Programme under Grant Agreement N. 818329.

7. References

Albaric, M., Nowag, J., Papillon, P., 2008. Thermal performance evaluation of solar combisystems using a global approach, in: Eurosun 2008, 1st International Congress on Heating, Cooling and Buildings. Lisbon, Portugal.

CEA, RINA-Consulting, Schneider Electric, Boostheat, CNR ITAE, CARTIF, AJSCV, GRE-Liège, BDR THERMEA, VEOLIA, Riga Technical University, EMVS, 2020. Report on baseline and boundary conditions of SunHorizon demo sites, including monitoring aspects (Public report No. D6.1), Sunhorizon no. 818329. INEA. <https://ec.europa.eu/research/participants/documents/downloadPublic?documentIds=080166e5cdaace9e&appId=PPGMS>.

Chèze, D., Lamaison, N., Breitenbach, P., Fuligni, F., 2018. Comparative Dynamic Performance Tests of Two Real Technology Packages for Buildings Heating System Retrofit, in: Proceedings of EuroSun 2018. Presented at the ISES EuroSun 2018 Conference. <https://doi.org/10.18086/eurosun2018.01.07>

Chèze, D., Cuneo, A., Macciò, C., Porta, M., Dino, G., Gabaldón, A., 2020. Four innovative solar coupled heat pump solutions for building heating and cooling, in: ISES Conference Proceedings. Presented at the Eurosun 2020. <https://doi.org/10.18086/eurosun.2020.04.07>

Lamaison, N., Chèze, D., Robin, J.F., Lefrançois, F., Bruyat, F., 2021. Operational Behaviour of a Solar-Fed Bidirectional Substation for 4GDH Networks, in: ISES Proceedings. SWC 2021 conference

Menegon, D., Persson, T., Haberl, R., Bales, C., Haller, M., 2020. Direct characterisation of the annual performance of solar thermal and heat pump systems using a six-day whole system test. *Renewable Energy* 146, 1337–1353. <https://doi.org/10.1016/j.renene.2019.07.031>

REN21, 2021. RENEWABLES 2021 GLOBAL STATUS REPORT. URL https://www.ren21.net/wp-content/uploads/2019/05/GSR2021_Full_Report.pdf.

Sayegh, H., 2020. Holistic Optimization Of Buildings Based On The Evaluation Of Annual Performances From Short Simulation Sequences. University of Savoie Mont Blanc, Le Bourget du Lac, France. URL <https://tel.archives-ouvertes.fr/tel-03219964>