

COMPONENT-EVALUATION FACILITY FOR HIGH CURRENT (200 A), SHORT TIME (2 μ S) AVALANCHE TESTING

Yvan LAUSENAZ, Jean-François VILLARD, Daniel CHATROUX

CEA VALRHO

DCC/DTE/SLC/LETC

BP 111 26702 PIERRELATTE - FRANCE

tel : +334 75 50 47 26 fax : +334 75 50 49 62

Dominique LAFORE

CEGEMA / ESIM

13451 MARSEILLE cedex 20 - FRANCE

tel : +334 91 05 45 23 fax : +334 91 05 45 65

Abstract - The new project for uranium enrichment SILVA (joint program CEA-COGEMA) needs specific power converters. These have been studied since 5 years by the *Copper vapor laser Technology and Electrotechnique Laboratory* of the C.E.A. in Pierrelatte. The aim of this laboratory consists in developing solid-state converters. In order to acquire a very good knowledge about components performances, tools were needed to characterize power components in extreme conditions. So a component-evaluation facility for high current short time avalanche testing has been created and is presented below.

1. INTRODUCTION

The *Copper vapor laser Technology and Electrotechnique Laboratory* (LETC) of the *Commissariat à l'Énergie Atomique* (C.E.A.), in Pierrelatte, is in charge of the study and development of power converters for the process of uranium enrichment by laser : SILVA. The specialty of this laboratory consists in replacing gas-tubes (thyratrons, ignitrons and tetrodes) by small solid-state standard components connected in matrix on printed circuit boards [1] [2].

These studies, conducted with the EEPS department of ESIM (Ecole Supérieure des Ingénieurs de Marseille), require a very good knowledge about component performances in avalanche mode. For this reason, a component-evaluation facility has been created.

Firstly, let us explain the vocabulary we use.

The clamping capability means the aptitude of a system to hold a voltage without limiting the current that crosses it. This function can be made with a single component (as a transistor for example) or with an association of several components [Figure 10]. The word **clamping**, for

a solid state component, is sometimes replaced by the word **avalanche** (controlled is understood) which is more suitable to the chip internal phenomenon in the silicon. This functioning mode is, within some limits, non-destructive for the component.

As in the dielectric domain, the **breakdown** describes an irreversible destruction of the component by filamentation of the silicon in the chip. This phenomenon is local while the avalanche is generally distributed (in the volume).

2. NEEDS

SILVA, as many other big facilities, requires a great number of power converters. Each of them have to be particularly reliable, in order to keep a low global failure probability.

Also these needs of reliability, availability and maintainability have led us to study power supplies topology at two different levels :

- ✦ Component : tests and choice of the best adapted components,
- ✦ Components association : choice, tests and sizing of structures having the greatest reliability [4].

In serial association of solid-state devices, overvoltages are brief [5] and do not imply overcurrent [6] [7]. Therefore, such associations need studies about general clamping structure, which ensure the voltage protection of each stage during short pulses.

2.1. Components characterization

2.1.1. Characteristics dispersion

Generally speaking, when a sample of several components, coming from the same source, has large dispersions on one or several characteristics, it means that the manufacturer process is not totally mastered. The existence

such a dispersion generally implies bad reliability for the system including these components.

Furthermore, the associations of many solid-state devices (in parallel, in series and in matrix) necessitate the lowest dispersion on characteristics (for instance breakdown voltage) in order to ensure good repartition of voltage and current during the different functioning phases.

2.1.2. Components performances

The reliability of an electronic facility depends on the reliability of the several components used. Therefore, tests are necessary to select the most robust and the most adapted components. Note that the test of all components is not necessary if the components population has a very low characteristic dispersion.

2.2. Components association characterization

One of the technological choices concerning solid-state components associated in series, deals with voltage balancement system. One technique is to avoid additional voltage balancement systems, static or dynamic. Important thing is then to ensure that every stage stays in its own voltage safety area [7] [6].

Thus the overvoltage protection on each stage of the serial association uses either :

- ↳ the passive clamping (typically a transistor or a varistor in parallel on the clamped device),
- ↳ The active clamping (reverse feedback on the control pin of the protected component, in order to regulate the voltage level [8]),
- ↳ The intrinsic clamping.

2.2.1. Manufacturer test method

The traditional avalanche test method consists in opening a current source.

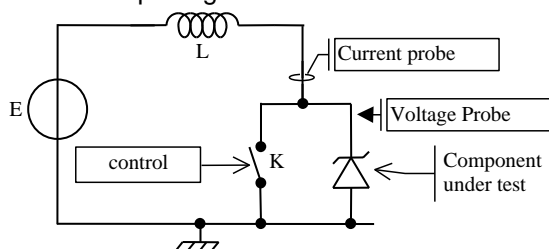

Figure 1 : test structure using the opening of a current source

This method, used for example in the manufacturer's process for diodes avalanche characterization, consists in rising a current in an inductance through a closed switch. Then its opening imposes the current in the component under test.

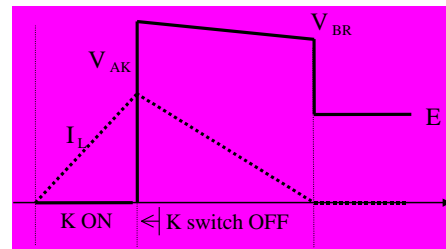

Figure 2 : associated waveforms

This test has the advantage of being simple. Nevertheless, it does not allow the independence of parameters (like the duration of the pulse and the level of current), and current form (triangular) and voltage form (trapezoidal) are difficult to use. Furthermore, the low current level and the long time scale used seem to be chosen to rise the specified energy level. This test method does not describe brief avalanche phenomena.

We have then designed a facility allowing the independent parameter adjustment (duration of the pulse, clamping current).

3. THE AVALANCHE MACHINE

3.1. Principle

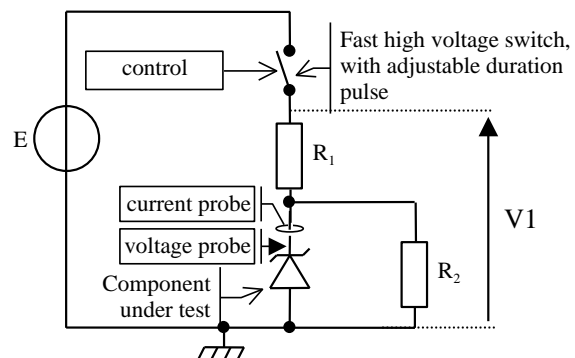

Figure 3 : Avalanche Machine structure

The principle is to apply a square pulse to the component under clamping test by switching ON the fast high voltage switch and by limiting the current with the resistor R1 [Figure 3]. Voltage and current waveforms are obtained by using a high voltage probe ($\times 100$, 2500 V_{max}) and a current probe (current coil 0,1 V/A).

While the voltage V1 stays under the clamping voltage of the component under test, this one supports this voltage and blocks the current.

Beyond the clamping voltage, the component under test limits the voltage (which depends on the current that crosses it), and the resistor R1 limits the current.

The different states of the component under test are :

1. **Blocking** : the voltage square pulse applied to the component is under the clamping value. The user fixes the voltage and the component under test blocks the current.

2. **Clamping** : beyond the clamping voltage (maximum voltage supported by the component), the user fixes the current value (named clamping current) while the component fixes the voltage value (that is a function of the current).

3. **Breakdown** : when the product voltage \times current \times time on the component under test reaches the maximum admissible energy, the chip is destroyed.

The following waveforms present an example of a 1200 V diode.

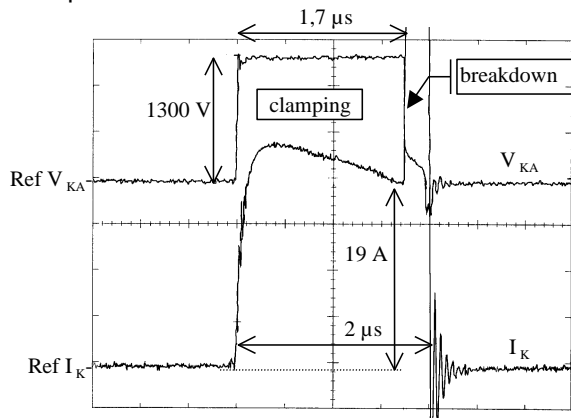

Figure 4 : Clamping and breakdown waveforms of a 1200 V diode

In the first part of the waveforms, the diode is forced to clamp about twenty amperes. With such a current, the component imposes 1300 V between its pins. After 1,7 μ s, the energy brought to the chip makes the junction temperature rise up to its bearable limit (short pulse \Rightarrow chip is in adiabatic mode). The silicon fuses and the chip is destroyed :

$$1300 \text{ V} \times 20 \text{ A} \times 1,7 \mu\text{s} = 44,2 \text{ mJ}$$

When the chip fails, the voltage falls, thus the current rises rapidly in the component. The breakdown is due to a filamentation in the silicon crystal [3].

3.2. Functions

The function of this component evaluation facility is to apply voltage square pulses (up to 2 kV) or current square pulses (up to 200 A), during an adjustable duration (several microseconds) to the component under test.

The Avalanche Machine answers to characterization requirements at different levels :

a) Component :

- clamping voltage measurement,
- clamping current bearable during 2 μ s,
- calculation of bearable clamping energy.

b) Component sampling :

- dispersion on clamping voltage,
- dispersion on energy reachable for 2 μ s.

c) Components associations :

- characterizations of clamping (active or passive) system.

3.3. Structure

The Avalanche Machine is made of :

\Rightarrow A fast high voltage switch (3500 V MOS Matrix), able to be switched during an adjustable duration (up to 50 μ s) and able to switch up to 320 A during short pulses (2 μ s). Frequency is 0,5 Hz to avoid the chip temperature to increase.

\Rightarrow Two resistors ; R1 for current limitation and R2 to discharge parasitic capacitance of the component under test.

\Rightarrow A metrology part (clamping current and voltage measurement).

\Rightarrow An external power supply up to 2 kV.

The high voltage fast switch used is one of the products developed by the LETC. It uses the matrix association of several small standard components (here 500 V, 0,85 Ω MOS). It can be switched ON and OFF independently, and it uses an active clamping structure to avoid any overvoltage problem when high currents are opened.

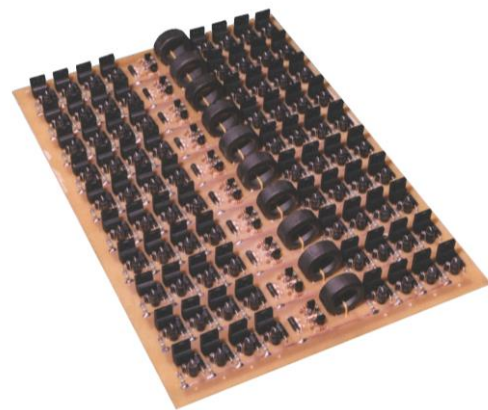

Figure 5 : MOS matrix photograph

3.4. Construction

The next figures present the Avalanche Machine.



Figure 6 : Avalanche Machine, closed



Figure 7 : Avalanche Machine, open

4. VOLTAGE CLAMPING STUDIES

4.1. Components selection

The Avalanche Machine allows to compare several solid-state devices. We selected criteria to determine if the component is able to run in avalanche mode.

4.1.1. Diodes

The selection criterion for a diode is the following : **A diode will be judged regarding its aptitude to clamping mode during 2 μ s. It will be considered :**

- └ bad if it does not support its nominal current as clamping current,
- └ good if it does support its nominal current as clamping current.

Pulses width is 2 μ s because overvoltages in serial associations are very short phenomena. The selected diodes, regarding these criteria, are used in series and in matrix association without voltage balancement system.

The next table presents the results of studies on several diode samples.

References	$I_{F(AV)}$	V_{RRM}	Classification
A1 type	12 A	1200 V	good
A2 type	15 A	1200 V	bad
A3 type	25 A	1200 V	bad
A4 type	20 A	600 V	bad
A5 type	8 A	1200 V	good
B1 type	3 A	200 V	good
B2 type	1,5 A	200 V	good

The following waveforms present an example of result concerning the aptitude of a B2 type diode to support 4 times its nominal current (4In) in clamping mode, during 2 μ s.

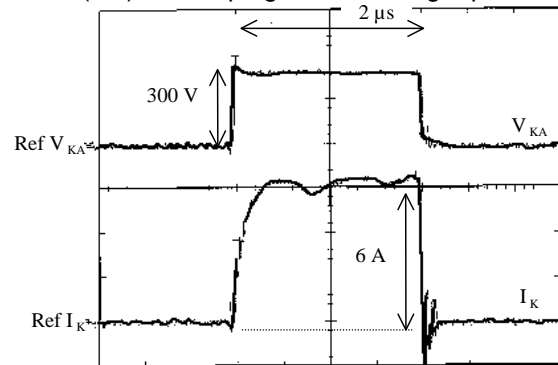

Figure 8 : B2 diode waveforms in clamping mode

4.1.2. 500 V MOS, 0,85 Ω

The choice of the 500 V MOS (0,85 Ω) used in matrix associations for the high voltage power supplies developed by the LETC for Copper Vapor Laser (CVL), was based on :

- └ Clamping mode aptitude, considering both the clamping voltage level and the bearable clamping energy.
- └ Low dispersion, on a component sample, for clamping voltage and bearable energy.

Next waveforms present the aptitude of the MOS used in MOS matrix to run in intrinsic clamping mode.

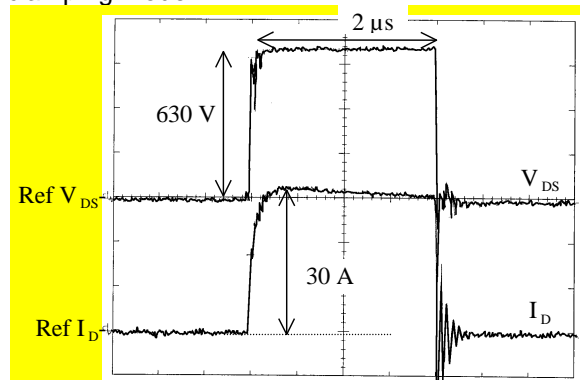

Figure 9 : 500 V MOS waveforms in intrinsic clamping mode

The clamping voltage level for low current is about 600 V. In Figure 9, for a 30 A current, this level reaches 630 V. The dissipated energy in the chip is then about 40 mJ. The maximum reached on this product has been 80 mJ, more than for the other manufacturers tested components.

4.2. Clamping system studies

4.2.1. Principal clamping modes

In a serial association of solid-state components, each of them has to be maintained in its voltage safety area. So a clamping system, passive or active, is required [9] :

☞ **Passive clamping** generally consists in a transil or a varistor in parallel with the protected component. It is cheap and easy to use, but the relatively high dynamic resistance of the protection can make the voltage reach the component breakdown voltage in case of high current.

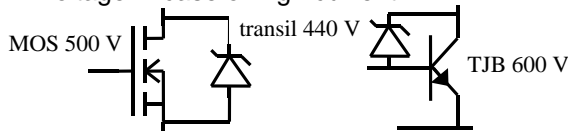

Figure 10 : passive and active clamping examples

☞ **Active clamping** is more difficult to implement. It consists in limiting the voltage on the protected component (TJB, MOS or IGBT) by using its control pin [8].

We can notice that recent components have good aptitude for the intrinsic clamping mode [Figure 9]. Although this capability is one of our choice criteria for MOS selection, this mode of voltage protection is never used alone. We prefer to use active or passive clamping.

With the Avalanche Machine, the clamping mode studies concern :

- a) Comparison between clamping systems :
 - dynamic resistances.
 - reached dissipated energies.
- b) Active clamping studies :
 - reverse feedback on the control pin stability.
 - stability in active clamping system in series.

4.2.2. Dynamic resistance

In a clamping system the dynamic resistance links the clamping voltage level to the clamping current.

Let us take a 500 V MOS clamped by a 440 V transil. With the passive mode, a high current through the diode can make the voltage reaches the breakdown voltage of the transistor (typically 600 V in our case). With active

clamping mode, and thanks to the very high MOS transconductance, the dynamic resistance stays at a low level (almost null). The voltage is here more constant.

The next waveforms present the clamping characteristics of a 500 V MOS, in active clamping mode, passive clamping mode (with a 440 V transil in the both case) and intrinsic clamping mode.

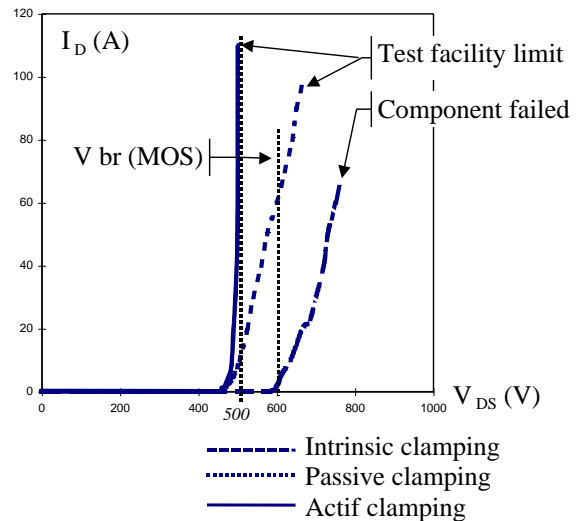

Figure 11 : three dynamics clamping mode characteristics

The **intrinsic clamping** of the MOS begins at 600 V. For a 60 A current, the voltage reaches 800 V, that corresponds to the maximum reachable energy in the chip for a 2 μ s test.

In the **passive clamping** mode, when the current is 60 A the diode clamping voltage reaches 600 V then the transistor clamps too. This mode has to be tolerated by the MOS.

In the **active clamping** the dynamic resistance is very low. The voltage never reaches more than 500 V [Figure 11], and the current level before destruction of the component is more important than in the intrinsic clamping mode. Here, the transistor runs not in intrinsic clamping mode but in linear mode.

4.2.3. Reachable clamping energy

The next table presents the difference of reachable energies in the MOS chip between active and intrinsic clamping.

	Intrinsic clamping	active clamping
test duration	2 μ s	2 μ s
reachable energy	80 mJ (maximum)	110 mJ*
reached current	65 A (maximum)	110 A*
current density	325 A/cm ²	550 A/cm ²

* : due to test facility limit.

In active clamping mode, the maximum reached current is about twice than in intrinsic mode (in case of short pulses).

4.2.4. Active clamping stability

As already said, the active clamping mode [Figure 12] can be viewed as an automatic system with a voltage control loop. The transil between the hot point and the control pin makes the reverse feedback.

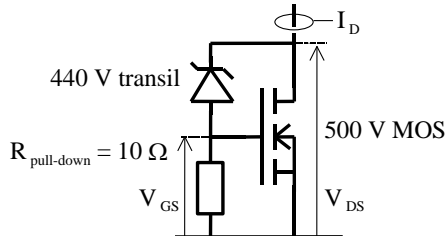

Figure 12 : common structure of an active clamping system using a 440 V transil as a voltage reference and a 500 V MOS

One of the difficulties concerns the regulation loop stability for low clamping current domain. Figure 13 shows waveforms obtained on the Avalanche Machine with such a clamping structure. Another voltage probe is used to show control signal.

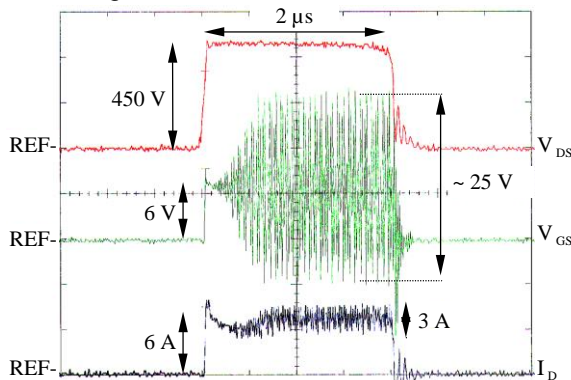

Figure 13 : active clamping waveforms for a 500 V MOS clamped by 440 V transil, in case of low current; control signal instability

In an unstable mode, the voltage level on the control pin can breakdown the gate oxide and destroy the component.

One solution consists in decreasing the gain of the regulation loop by adding a resistance (several ohms) in series with the transil, and in adjusting the pull-down resistance of the gate.

4.2.5. Stability in active clamping structure connected in series

Another problem concerning active clamping structure concerns its serial association. This point is now in progress, in collaboration with the

ESIM and the CENTRALP Enertronic company [2], which is the main industrial partner of our laboratory.

5. CONCLUSION

The designed component evaluation facility fully fulfills our needs in avalanche characterization of small standard components. It contributes to the development of a new range of switches having both high performances and reliability. Although the principle is easy, we can notice that it necessitates a fast high voltage high current (pulsed) switch with an adjustable switch ON duration.

Currently, studies continue on components characterization (e.g. performances evolution regarding the manufacturing date) and on serial association of active clamping structures.

A new Avalanche Machine is now in progress. With larger voltage and current ranges, 5kV and 500 A square pulses, this evaluation facility will be able to test serial and parallel components associations. For example, active clamping structure in series will be experimented on this new Avalanche Machine.

6. REFERENCES

- [1] D. CHATROUX, D. LAFORE, Interrupteurs rapides haute tension, application dans le domaine du nucléaire. *EPPF'96*, Grenoble, 16-18 déc. 1996, pp139-143
- [2] D. CHATROUX, Y. LAUSENAZ, J-F.VILLARD L. GARNIER, D. LAFORE, J-M. LI, Fiabilité des commutateurs 25 kV, 1600 A utilisant 3500 MOS. *EPPF'98*, Belfort, 16-18 déc. 1998, pp303-308
- [3] J. ARNOULD, P. MERLE, *Dispositifs de l'électronique de puissance*. Edition HERMES, Paris 1992
- [4] Y. LAUSENAZ, Etude de la fiabilité des mises en série de composants MOSFETs, rapport de DEA Génie Electrique, Faculté des Sciences & Techniques de St Jérôme Marseille, 1997
- [5] H. FOCH, T. MEYNARD, R. ARCHES, M. METZ, Etude comparative des techniques de mise en série dans les convertisseurs alimentés sous haute tension, *EPPF'92* Marseille
- [6] N. LAPASSAT, Etude du comportement en commutation douce des semi-conducteurs associés en série. Thèse de Doctorat, USTL, octobre 1998
- [7] R. GUIDINI, Interrupteur rapide haute tension réalisé par mise en série de composants semi-conducteurs pour convertisseurs de forte énergie. Thèse de Doctorat, USTL, janvier 1995
- [8] J-M. LI, D. LAFORE, S. TIAN, Energy absorption devices for solid-state interruption, *EPE journal* Vol.7 no 1-2 août-octobre 1997
- [9] T. REIMANN, R. KRÜMMER, J. PETZOLDT, Active voltage clamping techniques for overvoltage protection of MCT, *EPE'97* Trondheim