



HAL
open science

Short circuit of a high voltage high current MOSFET MATRIX Switch

D. Chatroux, Y. Lausenaz, J-F Villard, L. Garnier, R. Milly, D. Lafore

► **To cite this version:**

D. Chatroux, Y. Lausenaz, J-F Villard, L. Garnier, R. Milly, et al.. Short circuit of a high voltage high current MOSFET MATRIX Switch. PCIM2000 - 42th International Conference PCIM for Power Conversion & Intelligent Motion, Power Quality, Jun 2000, Nuremberg, France. cea-03293497

HAL Id: cea-03293497

<https://cea.hal.science/cea-03293497v1>

Submitted on 21 Jul 2021

HAL is a multi-disciplinary open access archive for the deposit and dissemination of scientific research documents, whether they are published or not. The documents may come from teaching and research institutions in France or abroad, or from public or private research centers.

L'archive ouverte pluridisciplinaire **HAL**, est destinée au dépôt et à la diffusion de documents scientifiques de niveau recherche, publiés ou non, émanant des établissements d'enseignement et de recherche français ou étrangers, des laboratoires publics ou privés.

Short circuit of a high voltage high current MOSFET MATRIX Switch

D. CHATROUX,
Y. LAUSENAZ,
J-F. VILLARD
+334 75 50 75 63
CEA VALRHO DTE / SLC /
LETC
BP 111 26702 PIERRELATTE
(France)
Fax : +334 75 50 49 62
Daniel.Chatroux@CEA.fr

L. GARNIER, R MILLY
+334 74 95 40 25
Centralp Enertronic
ZI Tharabie, rue du ruisseau
38290 St QUENTIN
FALLAVIER
(France)
fax : +334 74 95 40 29
L.Garnier@ENERTRONIC.fr

D. LAFORE
+334 91 05 45 23
CEGEMA ESIM
Technopôle de Château-
Gombert
13451 MARSEILLE Cedex 20
(France)
fax : +334 91 05 45 65
Lafore@esim.imt-mrs.fr

Keywords : High voltage switches, MOSFETS Matrix, standard components, reliability, short-circuit.

Abstract

In France, one joint program between Commissariat à l'Energie Atomique (C.E.A.) for the research part and COGEMA for the industrial application is the development of the Uranium Vapor Laser Isotopic Separation (SILVA).

The Power Electronic Laboratory from the C.E.A. in Pierrelatte is in charge of development on power supplies for Copper Vapor Lasers. For this application, the strategy of the laboratory is the association of thousands of small standard components on printed circuit board as a cost-effective high performance and reliable solution.

For PCIM, in 1999, [1] we presented a Key-note-paper about the strategy of the laboratory and we gave an overview of some different switches with MOSFETs, IGBTs, Thyristors, Diodes and nanosecond switches with standard MOSFETs.

The three first switches are very fast turn-on switches for capacitor lines or pulse forming network discharge applications. These three switches are not designed to switch off a high level of current.

For high voltage very fast applications, turn-off switches are very difficult because of short circuit. The inductance is low, so it is necessary for the switch to limit the current and to open this short-circuit current.

Now, we have a new fast 500 A MOSFETs MATRIX switch for high voltage modulator with a very good short-circuit behavior.

We present this new switch :

- 500 A 10 kV module
- switch short circuit behavior
- high voltage fast modulator design
- some industrial applications.

Introduction

The Commissariat à l'Energie Atomique (C.E.A.) carries out French nuclear researches. One of its projects is the development of the Uranium Vapor Laser Isotopic Separation (SILVA).

The Power Electronic Laboratory from the C.E.A. in Pierrelatte is in charge of researches and developments on power supplies for SILVA and particularly on power supplies for Copper Vapor Lasers. These lasers are pulsed powered, with low energy and high repetition rate.

First, we present different switches for thyatron and ignitron replacement in pulsed power applications. These switches are turn on switches. The switch discharge a capacitor, a coaxial line or a pulse forming network. At turn off, there is no energy in the circuit.

The very high level a reliability of a 25kV 1600A module without any additional cost is presented.

For other industrial applications, we develop another MOSFET switch for very fast turn on and turn off. Because of high voltage, short circuit is very difficult. We present this problem and the behaviour of this new switch.

1. Overview of high voltage high current turn-on switches for capacitor, line, or pulse forming network discharge

One of the copper vapor lasers for SILVA is a 100 watt one. This laser needs a 10 kilowatts average power supply. The typical requirements for this one are 25 kV output peak voltage, 1600 A output peak current, 200 ns pulse width and 5 kHz repetition rate. The average power is 10 kW, but the peak power is more than 10 MW, while the duty cycle is 0.1%.

At first, the power supply was made with two thyratrons in parallel but the cost of this solution was too high considering individual cost and low lifetime of thyratrons (1000 h). The cost of two thyratrons is 10 000 EUROS and they have to be replaced every two months in case of 24 hours a day working.

Hundred watts copper vapor lasers are industrial lasers and the challenge was the replacement of the thyatron switch by a reliable and cost-effective semiconductor high voltage switch in the same place and with the same cooling system.

A thyatron provides a very fast switch-ON in 20 ns. The dV/dt reaches 1 MV/ μ s.

In close collaboration with universities and particularly with the Ecole Supérieure d'Ingénieurs de Marseille (E.S.I.M.) [2], solid-state power supplies have been developed by our Laboratory to replace thyratrons in high voltage pulsed power applications. The main principle is serial [3] [4] or matrix connection of solid-state switch components.

Development studies of the industrial products are made by CENTRALP under contract. This company has excellent experience in electrical power products. The main result of this collaboration is an industrial MOSFETs module switching 25 kV - 1600 A.

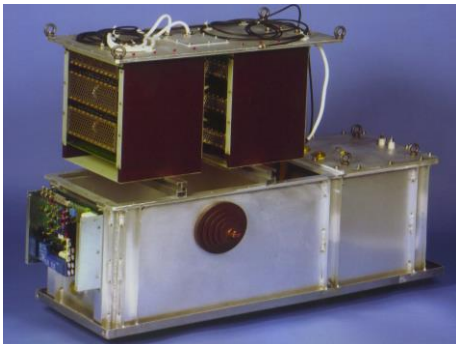

The 1600 A - 25 kV switch is a design of two modules in parallel, each containing five boards in series. Voltage specification for the board is 5 kV. Voltage drop is 20 ns typically.

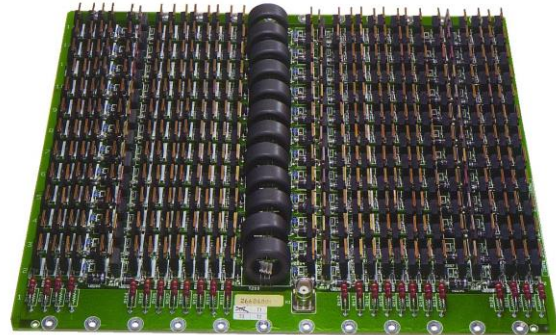

**350 MOSFETs board switching 5 kV - 1000 A
Centralp Enertronic**

For a new laser, the cost of a MOSFETs switch is about the same as for a thyatron with the same level of quality.

In fact, with the design of the switch, we have failure tolerance without any additional cost, without over-cost. We observe that the failure of one or some components is not a problem and that the global switch keeps the same behavior. For this design, with a small safety margin, the reliability of the module is very high because it is tolerant towards some component failures. One of the subjects of the laboratory is a basis study of reliability of components linked in series and in matrix [5] [6].

In the end of 1999, the 30 different switches for copper vapor laser accumulate 150 000 hours without any failure for the MOSFET switches.

MOSFETs switches are industrial switches with a demonstrated high reliability. More than 300 boards have been produced. Other switches have been designed :

- IGBTs boards,
- THYRISTORS matrix switches including small standard thyristors, involving very low costs and high dI/dt ,
- DIODES matrix switches linked in series with the MOSFETs boards,
- NANOSECOND solid-state switch.

2. High voltage pulsed electric field as a bactericidal process

With high voltage pulsed electric field is possible to kill microorganisms in liquids, pumpable media and food. It's an emerging pasteurization process without thermal degradation of the food [7] [8]. It's a bactericidal process for water treatment [9].

The microbial cell envelope is a capacitor. The high electrical field pulses cause an electroporation of the cell [10].

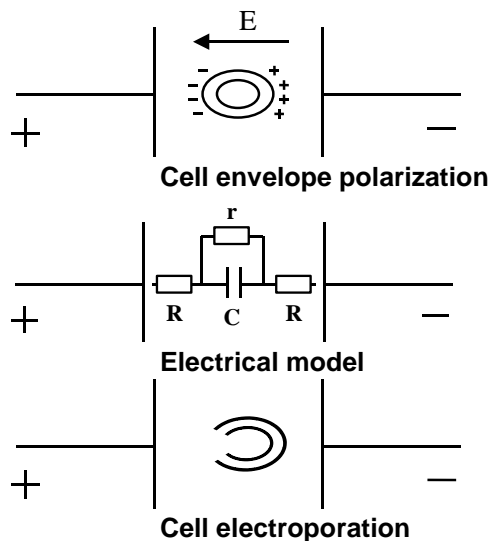

At low voltage, for genetic application the cell recovers. For high voltage, such poration is massive and prevents cell recovery.

Application of high voltage pulsed electric field leads to irreversible cell membrane breakdown in microorganisms while causing little loss in food flavor and taste compared to traditional thermal pasteurization.

The level of electric field is about 15 to 50 kV/cm in the media.

The first design for the pulsed power generator as the same as for a Copper Vapor Laser power supply.

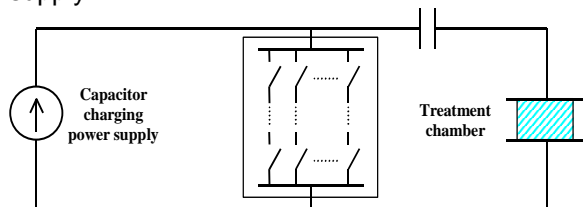

A capacitor or a coaxial line or a pulsed forming network can be used for the energy storage. The thyatron or the matrix mosfet

switch discharges all the energy in the treatment chamber. The high voltage switch is a turn-on switch. There is no energy at turn off.

This design provides mono-polar pulses. The pulse duration is charge resistance dependent.

3. New turn-on and turn-off short-circuit proof MOSFET MATRIX switch.

For food or water treatment studies, it is important to generate bipolar pulses with tunable duration. The pulsed power generator design is :

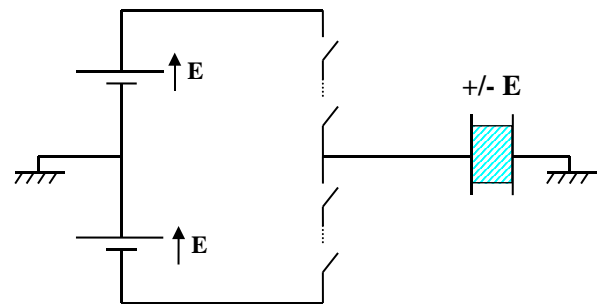

The two high voltage switches are turn on and turn off switches.

In the treatment chamber, because of high electric field a short circuit may occur.

Generally speaking, there are two cases for short-circuit :

- Short-circuit for the converter with di/dt limitation with an inductor,

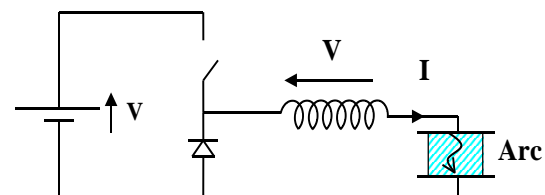

- Short-circuit with low inductance and auto-limitation of the switch.

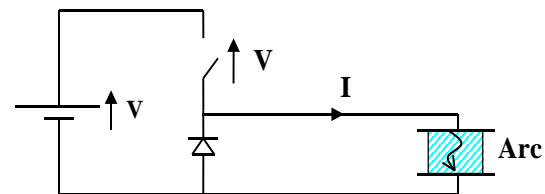

For high voltage fast modulator, the stray inductance has low value, so the short-circuit current is limited by the switch.

For low voltage applications, short-circuit of the switch is only short-circuit of one component or some components in parallel. The MOSFET or IGBT component auto-limits the current and the power supply limits the component voltage. The short-circuit voltage is the power supply voltage and the component is in its accidental safety area.

For high voltage applications, the switch is made of components in series. The components limit the short-circuit current and the power supply voltage is sustained by the components in series.

It is necessary to have a very good active [11] or passive clamping on each stage to keep the different components in their safety area.

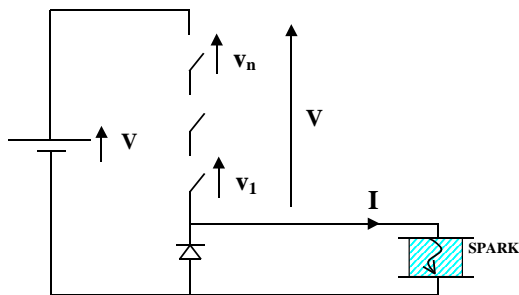

After this current auto-limitation, it's necessary to switch-off the short-circuit current. Because of high dI/dt , there is an over-voltage generated by stray-inductance. It is necessary to keep all the components in their safety area.

The design for the turn-on and turn-off short-circuit proof switch is very difficult. For high voltage, the rise time of the current in the spark is very fast. Because of the stray capacitance, there is a wave propagation with high voltage, high current, very fast dV/dt and dI/dt .

A first 200 A 3 kV switch has been tested in our laboratory with a very good short-circuit behavior.



Tunable spark gap

A tunable spark gap is used as a very fast short-circuit switch. Here we see :

- a high voltage probe,
- a low inductance wiring with copper plates,
- a spherical electrode,
- and a micrometric tunable electrode.

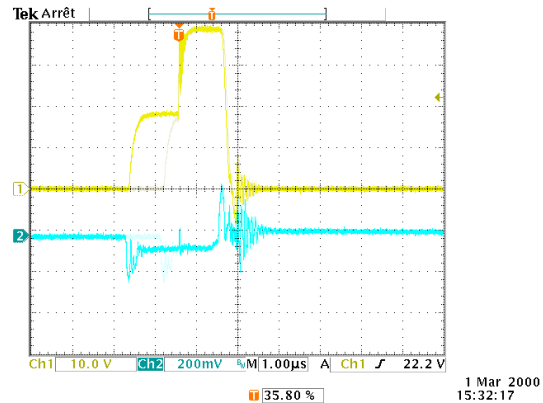

This is the short circuit behavior for a switch. The upper trace is the current in the switch.

We see the :

- switch on,
- nominal current,
- short-circuit of the switch,
- current auto-limitation for the switch,
- switch off with short-circuit current.

The lower trace is the driver current.

We design a 500 A 5 kV standard Mosfet matrix for high voltage very fast modulators. The first four industrial boards are made by CENTRALP, and are tested in our laboratory.

The standard module is made with two Mosfets Matrix in series, some diodes in series, high voltage matrix diode in anti-parallel and a transformer for the driver. The isolation for all the stages is made with a high voltage cable.

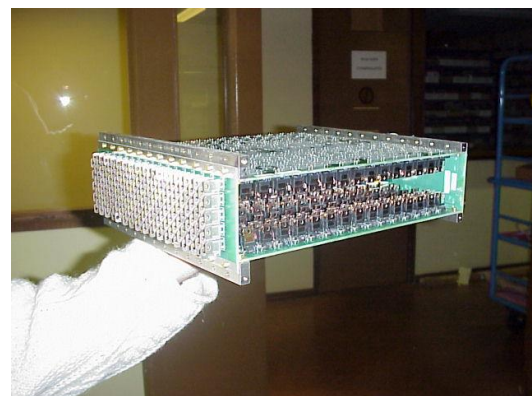

10 KV 500 A turn-on turn-off and short-circuit proof module and anti-parallel matrix diode.

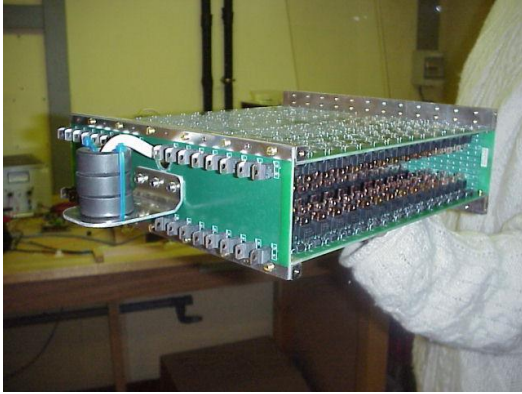

High voltage driver transformer and diodes in series with the Mosfet Matrix.

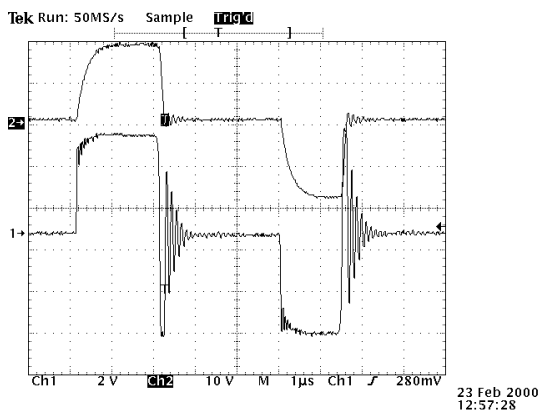

**Upper trace : voltage across the treatment.
Lower trace : voltage on the middle point of the switches.**

CONCLUSION

Pulsed electric field treatment is an emerging nonthermal food preservation technology for pasteurization replacement. It's a bactericidal process for water treatment. Our traditional Mosfet Matrix turn-on switch is a very reliable solution for industrial mono-polar generator. This solution, replacing thyatron, proved 150 000 accumulated working hours without failure of the switch.

For bipolar generator with tunable pulse duration we developed a new Mosfet switch. This switch is a turn-on and turn-off one with a very good short-circuit behavior.

Two printed circuit boards are associated in series to make a 10 KV module. We associate these modules in series.

For water treatment a +/- 25 kV modulator is designed with two 50 KV switches. Centralp Enertronic is now building the modulator.

References

- [1] D. Chatroux, Y. Lausenaz, J.F. Villard, L. Garnier, D. Lafore, Power switch : the standard small components strategy. Key note paper, PCIM'99, Nuremberg, 22-24 juin 1999.
- [2] R. Guidini, Interrupteur rapide haute tension réalisé par mise en série de composants semi-conducteurs pour convertisseurs de forte énergie. Thèse de Doctorat, USTL, janvier 1995.
- [3] R. Guidini, D. Chatroux, Y. Guyon, D. Lafore, Semiconductor power MOSFETs devices in series. EPE'93 Brighton Septembre 1993.
- [4] R. Guidini, D. Chatroux, Y. Guyon, D. Lafore, B. Hennevin : 15 kV Switch made of semiconductor power MOSFETs devices in series. PCIM'94, Nuremberg Juin 1994.
- [5] D. Chatroux, Y. Lausenaz, J.F. Villard, L. Garnier, D. Lafore, J.M. Li, Fiabilité des commutateurs 25 kV, 1600 A utilisant 3500 MOS. EPF'98, Belfort, 16-18 décembre 1998.
- [6] Y. Lausenaz, Etude de la fiabilité des mises en série de composants MOSFETs, rapport de DEA Génie Electrique / ESIM, Faculté des Sciences & Techniques de St Jérôme Marseille, 1997.
- [7] Knorr D., Geulen M., Grahl T., Sitzmann W., "Food application of high electric field pulses", Trends Food Sci. Techno., 1994
- [8] Qiu X ;, Sharma S., Tuhera L., Jia M., Zhang Q.H., "An integrated PEF Pilot Plant for continuous nonthermal pasteurization of fresh orange juice"
- [9] Bustritskii V.M., Wood T.K., Yankelevich Y., Chauhan S., Yee D., Wessel F., "Pulsed power for advanced waste water remediation", 11th IEEE International Pulsed Power Conference
- [10] Schoenbach K.H., Abou-Ghazala A., Vithoulkas T., Alden R.W., Turner R., Beebe S., " The effect of pulsed electrical fields on biological cells", 11th IEEE International Pulsed Power Conference
- [11] Lausenaz Y., Chatroux D., Villard J.F., Lafore D., Li J.M., Garnier L., "Serial connected active voltage clamping", EPE'99, Lausanne, 7-9 septembre 1999.