



HAL
open science

MOSFETs, Thyristors and diodes matrixes for high voltage and pulse power

D. Chatroux

► **To cite this version:**

D. Chatroux. MOSFETs, Thyristors and diodes matrixes for high voltage and pulse power. PCIM 2008 - Power Conversion and Intelligent Motion Europe, Jun 2008, Nuremberg, France. cea-03293234

HAL Id: cea-03293234

<https://cea.hal.science/cea-03293234>

Submitted on 20 Jul 2021

HAL is a multi-disciplinary open access archive for the deposit and dissemination of scientific research documents, whether they are published or not. The documents may come from teaching and research institutions in France or abroad, or from public or private research centers.

L'archive ouverte pluridisciplinaire **HAL**, est destinée au dépôt et à la diffusion de documents scientifiques de niveau recherche, publiés ou non, émanant des établissements d'enseignement et de recherche français ou étrangers, des laboratoires publics ou privés.

MOSFETs, Thyristors and diodes matrixes for high voltage and pulse power

D. Chatroux, CEA 17, rue des Martyrs, 38504 Grenoble Cedex, France
daniel.chatroux@cea.fr

Abstract

For the high voltage tubes replacement in pulsed laser applications, CEA developed a technology of matrixes of small standard components for kilo-Amps and kilo-Volts commutation. MOSFET matrix switches are used for microsecond and sub microsecond pulses. Small thyristors matrix switches are used for tens of micro-second pulses, up to milliseconds. Standard ultrafast diodes matrixes are used for freewheeling or blocking the current.

This technology proved to be cost effective and a very high reliability. For laser, the MOSFETs matrix switch has the same cost than the gas tube (thyatron) one and the reliability is 200 times higher. The tube lifetime is 1000 hours. The matrix switch lifetime is 200 000 hours. The matrix is failure tolerant. So it's not a random failure with MTBF specification, but a full lifetime without risk of failure for the switch for years.

This technology has been used in a large area of applications. An industrial society has a licence to develop this technology with the necessary technical and EMC know-how.

The purpose of the presentation is to give an overview of the applications and of the technical performances.

1 Matrix switches technology

1.1 First application: pulsed power lasers

In pulse power applications, vacuum and gas tubes and spark gap are the standard solutions for the kilo-Amps and kilo-Volts switching. The life time of vacuum and gas tubes is around 1000 hours. The number of commutations is limited for spark gap.

In 1992, the cost of tubes replacement in copper laser was a blocking limitation for a uranium enrichment process in CEA. These lasers run 24 hours a day and more than 300 days per years.

Because of these needs, the replacement of tubes with matrixes of MOSFET was developed.

In a laser the initial 25kV 1600A 20ns switch is designed with two thyratrons in parallel. This switch was replaced in the same volume by a matrix of 3500 MOSFETs [1]. As for the tubes, the all components are in mineral oil for cooling and high voltage insulation.

Because of the low cost of standard MOSFETs connected together on printed circuit board the cost of the switch system is the same as the tubes one (tubes, auxiliaries, enclosure, mechanical parts...).

In case of the failure of one MOSFET, there is one stage less for voltage sustaining. This is compatible with the small (10%) voltage safety margin. But because of the powerful drive, all the others MOSFETs in parallel with the failed MOSFET are conducting in the one state, and the current spread in all the components. There is no failure propagation. The switch is failure tolerant, up to six failed MOSFETs. In this application the switch design provides 200 000 hours [2] without failure.

The circuit of a copper vapour laser pulsed power supply is:

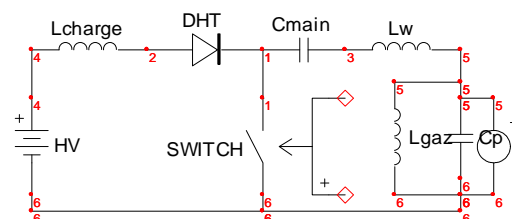

The charging circuit is a resonant one. The main capacitor is charged by the power supply with the low frequency resonance between C_{main} and L_{charge} . The values of the others inductors are negligible. The charging current goes through the gas inductor, not to go through the laser. This

inductor is done with a tube to provide the circulating gas for the laser at the laser head. The charging time is around 70µs to 100µs for example.

After the charging phase, the diode DHT blocks the reverse current. Cmain voltage is twice the power supply voltage if the Cmain initial voltage is zero. If a negative Cmain initial voltage exists, the charging voltage is higher.

When the switch turns on, a negative voltage is applied to the laser. The discharge circuit is a multi resonant one to accelerate the voltage slew-rate on the laser head and the current slew-rate in the laser.

The current pulse duration is only 200 ns. For this very short duration MOSFETs with a powerful drive are well adapted.

1.2 Turn-on and turn-off and short circuit switches

In a second phase, MOSFETs switches with turn-on and turn-off and short circuit proof are designed.

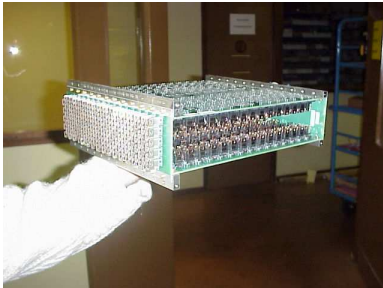

Fig. 1 500A 10kV turn on and turn off switch.

The upper figure is relative to a block of two 5kV printed circuit boards associated in series and a anti parallel matrix diode. The matrix diode is only the association of avalanche selected diodes in a matrix without any additional component for equilibrium or clamping.

A specific drive is designed around the specific high voltage transformers. These transformers are done with standard ferrite cores and high voltage cable which goes through the cores.

As for the diode, the MOSFETs are selected with the criteria of avalanche current. MOSFETs and Zener diodes are associated to bear the maximum short circuit current.

For the same printed circuit board surface the maximum current is 1000 A for thyristor function switch and 500 A for full control switch (turn-on turn off and short circuit proof).

This technology is easier to use than competitors ones which are not short circuit proof. An additional resistor or inductor is necessary to limit the short circuit current to an acceptable level for the switch. This additional component limits the switching speed for normal turn-on and turn-off.

In our technology, the limitation is done by the MOSFETs (saturation current) and there is no additional component. The voltage drop of the MOSFET matrix switch is less than 20 ns.

An application is high current high voltage inverters for plasma generators [3]. Another one is the replacement of vacuum tubes in Tokamak [4]. These tubes are used as 10 Amps, 50 kV switches for short circuit protection. These applications are described later.

1.3 Resonant switches

For the realisation of high voltage converters, two designs of resonant switches are developed:

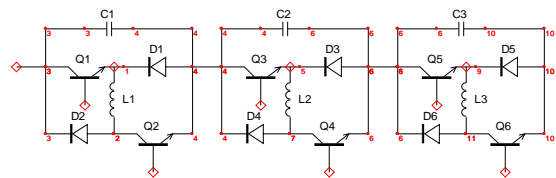
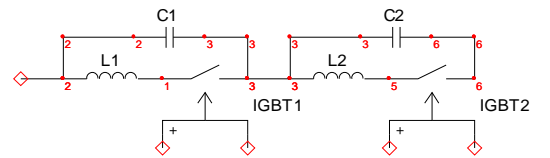

These switches are tested for a buck converter. The application is the high voltage regulation and protection for high voltage power supplies.

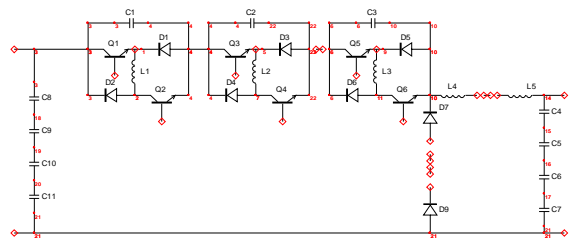

For this design, the switch is an association of ZVS ZCS resonant cells, the input and output capacitors are capacitors in series, the diode is an association of diodes in series. The inductor is an association of standard winding on ETD49 ferrites in series. This inductor design is well

adapted to provide a low internal parasitic capacitance.

Due to the resonant switch, the stray capacitances of the high voltage connections between the components themselves and with the metallic enclosure don't generate additional commutation losses but only resonance frequency modification.

This design was tested for a 10 kV 10 kW converter

1.4 Electromagnetic Compatibility

Because of the huge voltage and current slew rate, electromagnetic compatibility is a difficult challenge. For example, the first 25 kV 1600A MOSFET switch turn on with a 20 ns voltage fall time. The dV/dt is 1 MV/ μ s. The second generation of "thyristor function switch" with three times more current in the same printed circuit board surface has a voltage fall time of around 7 ns.

It's the same problem of EMC than in the others standard power supplies, but the orders of magnitude are higher. With the faraday effect of the enclosure, low distance between the wires and metallic foils, and a cascade of some common-mode chokes, it's possible to have a good design with the drive on the enclosure and digital functions and the controls on the switch.

For all this high voltage pulses applications as for the high voltage power supplies (which have very fast dV/dt in case of short circuit) a very good EMC know-how is necessary [5].

2 Applications

2.1 Bacteria electroporation application

The goal of this part of the presentation is to do an overview of applications for the matrix switch technology.

The initial application of the turn-on and turn-off and short circuit proof switch is to do an inverter for bacteria electroporation in water.

A mean to kill bacteria in food or in water is to generate a very short high voltage pulse.

The voltage around the bacteria generates a hole in its membrane. Depending of the size of the hole in the membrane the bacteria is killed.

This phenomenon is the electroporation. One of the key interests of this technology is to maintain the organoleptic quality of the food. For water the

advantage is the low energy consumption for high volume treatment.

The structure is a half bridge with two 30 kV power supplies. The two 60 kV switches are an association of 5 kV 500A printed circuit boards in series. Direct diodes for blocking the reverse current and antiparallel matrix diodes are used.

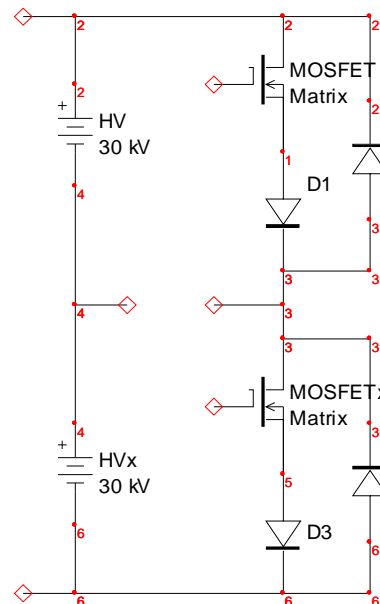

The diodes matrixes are made with small standard diodes. These diodes are avalanche proof. They are not specific diodes but power electronic standard diodes which are selected. The diodes are not individually tested. It's only a reference and supplier qualification test.

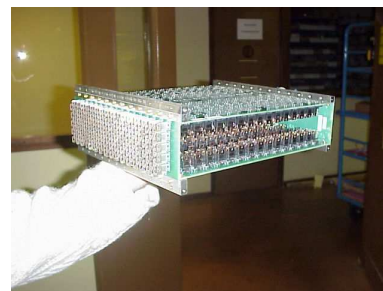

Fig. 2 500 A 10 kV turn on and turn off switch

The global generator was tested in short circuit with a tunable spark-gap on the output.

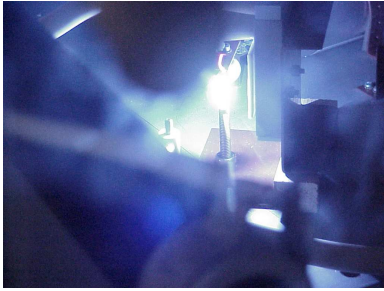

Fig. 3 Short circuit test with a spark gap on the output

The equipment was qualified for water treatment for an industrial cooling circuit.



Fig. 4 +/- 30 kV 500A inverter for water purification (bacteria electroporation)

2.2 High power excimer laser application

Because of the MOSFET technology evolution, it's possible to switch 3000A with the same surface of PCB than the initial 1000 Amps one.

With these MOSFETs matrixes a high power excimer pulsed power supply has been realised. In this application the specifications are:

- 30 kV
- 30 kA
- 200 ns pulse duration

- 500 Hz repetition rate



Fig. 5 30 kV 30 kA switch for excimer laser.

For this application a switch with 20 000 MOSFETs in a single switch has been done. There are ten individual switches in parallel. Each switch is a 3kA one with six printed circuit boards in series. With these MOSFETs the voltage fall time is about 7ns.

2.3 plasma generation application

The first realizations are in oil because thermal transfer reasons and high voltage insulation. For low frequency or burst applications, some realizations are in air.



Fig. 6 High voltage inverter for plasma application

The internal structure is a half bridge. It's the same structure than bacteria electroporation one.

2.3 Protection for megawatt high voltage power application

For Tokamak, a high number of high voltage power supplies are used for high frequency tubes generators.

The level of voltage is around 50kV. The range of power is half a megawatt up to megawatts.

Tubes are used in parallel on the same power supply. In case of spark in one tube, it's necessary to protect the tube with a defect very quickly.

Matrices of small thyristors are used for this application. But the impact is the loss of power not only from one tube but from all the tubes in the same power supply.

A difficult problem is to design an individual opening switch to protect individually each tube.

This switch is normally on.

With specific drive, it's possible to do 10-20 Amps of permanent current with a sustaining voltage of 100 000 volts.

This switch provides the serial protection for megawatts power supplies in Tokamak applications.

Technology, 20 - 24 Septembre 2004 - Venise, Italie.

[5] Chatroux, D.; Lausenaz, Y.; Villard, J.F. CEM d'une alimentation impulsionnelle 25 kV / 1600 A commutant à 1 MV/μs. CEM EXPO 99, Paris 15e, 13-14 octobre 1999.



Fig. 7 High voltage serial protection switch for megawatt power supplies

3 Conclusion

A technology using small standard components for specific research or industrial applications was developed and proved cost effectiveness and very high level of reliability.

The applications domains are large and components progress allows reaching new challenges.

This technology is transferred to industry with a long time partnership.

4 Literature

[1] Chatroux, D.; Lausenaz, Y.; Villard, J.F. ; Garnier, L.; Lafore, D. ; Power switch : the standard small components strategy. PCIM'99, Nuremberg, 22-24 juin 1999.

[2] Chatroux, D.; Lausenaz, Y.; Marc, S.; Villard, J.F.; Rigole, H.; Milly, R.; Lafore, D.; Li, J.M.; Reliability rules for high voltage high current MATRIX switches. PCIM 2001, Nuremberg, 19-22 juin 2001.

[3] Chatroux, D.; Lausenaz, Y.; Villard, J.F.; Garnier, L.; Milly, R.; Lafore, D.; Short circuit of a high voltage high current MOSFETs matrix switch. PCIM 2000, Nuremberg, 6-8 juin 2000.

[4] Beaumont, B.; Bertrand, E.; Brugnetti, Cha-troux, D.; Kazarian, F.; Milly, R.; Prou, M.; Rigole, H.; 100 kV solid-state switch for fusion heating systems. 23rd Symposium of Fusion