



HAL
open science

The geometry of ICRF - Induced wave-SOL Interaction

L Colas, G Urbanczyk, M Goniche, J Hillairet, J.-M Bernard, C Bourdelle, N Fedorczak, C Guillemaut, W Helou, V Bobkov, et al.

► To cite this version:

L Colas, G Urbanczyk, M Goniche, J Hillairet, J.-M Bernard, et al.. The geometry of ICRF - Induced wave-SOL Interaction. IAEA FEC 2021 - The 28th IAEA Fusion Energy Conference, May 2021, Nice (E-conférence), France. cea-03245019

HAL Id: cea-03245019

<https://cea.hal.science/cea-03245019>

Submitted on 1 Jun 2021

HAL is a multi-disciplinary open access archive for the deposit and dissemination of scientific research documents, whether they are published or not. The documents may come from teaching and research institutions in France or abroad, or from public or private research centers.

L'archive ouverte pluridisciplinaire **HAL**, est destinée au dépôt et à la diffusion de documents scientifiques de niveau recherche, publiés ou non, émanant des établissements d'enseignement et de recherche français ou étrangers, des laboratoires publics ou privés.

THE GEOMETRY OF ICRF – INDUCED WAVE-SOL INTERACTION

L.Colas¹, G.Urbanczyk^{1,2}, M. Goniche¹, J. Hillairet¹, J.- M. Bernard¹, C. Bourdelle¹, N. Fedorczak¹, C. Guillemaut¹, W.Helou³, V.Bobkov⁴, R.Ochoukov⁴, Ph.Jacquet⁵, E.Lerche^{5,6}, X. Zhang², C. Qin², C.C.Klepper⁷, C.Lau⁷, B.VanCompernelle⁸, S.J. Wukitch⁹, Y.Lin⁹, M.Ono¹⁰, the JET team, the ASDEX upgrade team, the EAST team and the WEST Team¹



upgrade team, the EAST team and the WEST Team¹

¹ CEA, IRFM, F-13108 St-Paul-Lez-Durance, France

² Institute of Plasma Physics, CAS, Hefei, Anhui 230031, PR China

³ ITER Organization, Route de Vinon sur Verdon, CS 90 046 - 13067 St. Paul lez Durance cedex, France

⁴ Max-Planck Institut für Plasmaphysik, Boltzmannstraße 2, 85748 Garching, Germany

⁵ CCFE, Culham Science Centre, Abingdon, Oxfordshire OX14 3DB, UK

⁶ Laboratory for Plasma Physics, Royal Military Academy, 1000 Bruxelles, Belgium

⁷ Oak Ridge National Laboratory, 1 Bethel Valley Rd, Oak Ridge, TN 37830

⁸ General Atomics, San Diego, California, USA

⁹ Plasma Science Fusion Center, MIT, Cambridge, MA, 02139, USA

¹⁰ Princeton Plasma Physics Laboratory, Princeton, NJ 08543, USA

Laurent.colas@cea.fr



ABSTRACT

As part of ITPA-IOS activities, this contribution reviews recent experimental characterization of ICRF-induced SOL modifications on various tokamaks worldwide and on the Large Plasma Device (LAPD) at UCLA. The phenomenology, as observed using a large variety of measurement techniques, is consistent with the expectations from RF-sheath rectification. Emphasis is put on the complex 3D spatial structure of RF-SOL interaction, in relation to the magnetic topology and the spatial distribution of RF currents over the metallic structures. Dependence on the local plasma parameters in the antenna vicinity is also briefly addressed. The final part discusses implications for future devices.

RF-sheath phenomenology

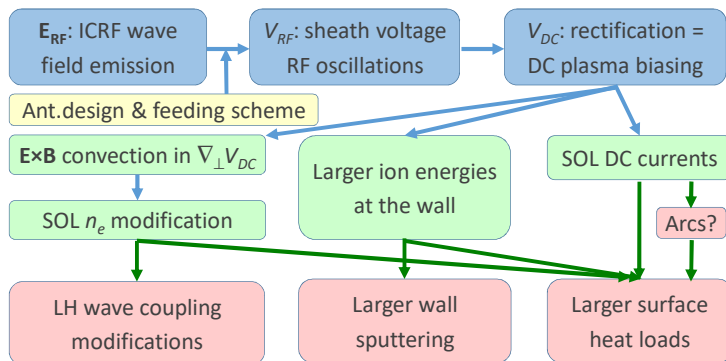

• Other processes on top? Coaxial modes, ponderomotive forces, LH reson.?

Complex 3D geometry of RF-sheath effects

Parallel structure

- Appears mainly on open magnetic field lines passing close to active ICRF wave launchers.
- Long parallel extent, sometimes to divertor → 2D mappings from remote diagnostics
- Parallel variations? Private SOL of antenna?

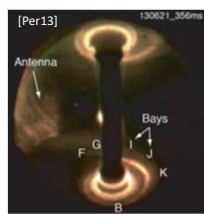

Radial localization

- Radial maximum near leading edge of antenna limiters
- Shifts radially with antenna movement
- Extension ~few cm. Parametric variation?
- Limited consequences on SOL transport

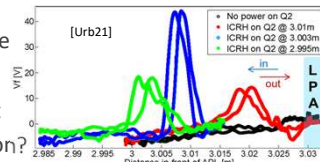

“Universal” poloidal structure?

- Poloidal maxima do not necessarily appear on antenna part closer radially to the plasma
- Rather near antenna box corners.
- Observed over many antenna types with diverse strap electrical settings

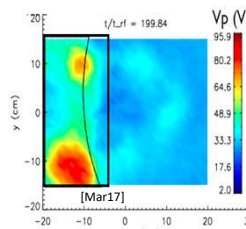

... Plus “far-field” effects suspected

- Appears on open magnetic field lines never connected to active antenna.
- Detailed geometry poorly characterized.
- Likely sensitive to plasma scenario, via single pass absorption?

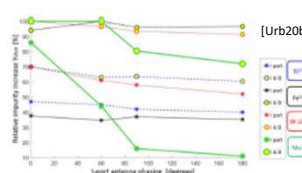

Link with geometry of RF currents over antenna structure

For given antenna and plasma, V_{DC} increases with antenna RF-voltage

- ~ linearity plus offset due to thermal sheath

2-strap antennas:

- Optimal working point for balanced strap power and $[0\pi]$ phasing
- Not pronounced → sheaths are not suppressed

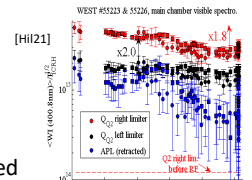

3-straps phased $[0\pi 0]$, 4-straps $[0\pi\pi 0]$, $[0\pi 0\pi]$

- More voltage on central straps is beneficial
- Much stronger RF-sheath reduction
- Power limitations if strong voltage unbalance

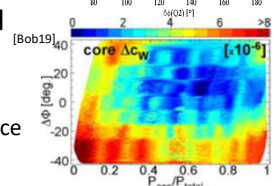

Single strap in bulk ceramic box (LAPD)

- No measurable rectification outside box.

All optimal points → minimal RF current induced on antenna box sides

- Box current cancellation measured on ASDEX upgrade 3-strap antenna
- Box explains “universal” poloidal structure?
- Field-alignment is beneficial (ALCATOR C-mod)
- Why? Similar V_{DC} measured near box corners
- Requires antenna outside port.

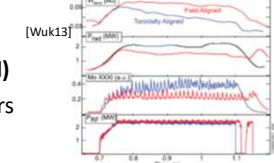
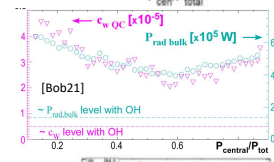

Effect of local plasma parameters on near-field RF-sheaths

- Local plasma density & temperature determine particle flux onto PFCs.
- Local gas injection was applied successfully to restore good LH wave coupling in ICRF-disturbed convective cells and to enhance ICRF coupling without disturbing the plasma core in H mode. This also lowered the W production at the ASDEX-upgrade antenna limiters.
- Plasma composition matters: majority ions, but also low-Z impurities, intrinsic or injected on purpose (seeding for divertor radiation).

Outlook for future long-pulse metallic DT machines

- Only “near-field” RF sheaths are well documented. “Far-field” RF-sheath reduction: ensure good single pass absorption, avoid low- $k_{||}$ spectra.
- Antenna actuators identified to mitigate “near-field” sheaths on 3-strap or 4-strap antennas: 1) box current cancellation or 2) field-alignment. 1) may be implemented on ITER antenna with reasonable strap unbalance.
- Other antenna concepts were proposed for reactors, e.g. Travelling Wave Arrays. They remain to be tested in metallic environment.
- Local gas injection is envisaged in ITER to increase the ICRF coupling resistance and possibly reduce the sputtering. It should be easily decoupled from core plasma fueling. Local plasma tailoring requires plasma measurements as close as possible to the antenna.
- DT: Isotope effects on impurity production presently investigated at JET
- Long-pulse operation in actively-cooled environment: Active wall monitoring system and real-time safety procedures are necessary.

REFERENCES for figures (more extensive list in proceedings)

[Bob19] : V. Bobkov et al. *Nuclear Materials and Energy* 18 (2019) pp. 131–140; [Bob21] : V. Bobkov et al. Private communication, manuscript in preparation. (2021); [Hil21] : J. Hillairet et al. « WEST actively-cooled load-resilient Ion Cyclotron Resonance Heating results », this conference (2021); [Mar17] : M. J. Martin et al. *Phys. Rev. Lett* 119, 205002 (2017); [Per13] : R.J. Perkins et al. *Nucl. Fusion* 53 083025 (2013); [Urb20b] : G. Urbanczyk et al. *Nucl. Fusion* 60 (2020) 126003; [Urb21] : G. Urbanczyk et al. *Nuclear Materials & Energy* 26 (2021) 100925; [Wuk13] : S.J. Wukitch et al., *Physics of Plasmas* 20 056117 (2013);