



HAL
open science

Spectroscopic, pressure and temperature measurements of the reactant mixing process in sodium-water reaction

Lucas David, Mirjana Milanovic, Philippe Hervé, Yannick Bailly, David Ramel, François Beauchamp, Alexandre Allou

► **To cite this version:**

Lucas David, Mirjana Milanovic, Philippe Hervé, Yannick Bailly, David Ramel, et al.. Spectroscopic, pressure and temperature measurements of the reactant mixing process in sodium-water reaction. Nuclear Engineering and Design, 2020, 364, pp.110638. 10.1016/j.nucengdes.2020.110638 . cea-02573019

HAL Id: cea-02573019

<https://cea.hal.science/cea-02573019>

Submitted on 14 May 2020

HAL is a multi-disciplinary open access archive for the deposit and dissemination of scientific research documents, whether they are published or not. The documents may come from teaching and research institutions in France or abroad, or from public or private research centers.

L'archive ouverte pluridisciplinaire **HAL**, est destinée au dépôt et à la diffusion de documents scientifiques de niveau recherche, publiés ou non, émanant des établissements d'enseignement et de recherche français ou étrangers, des laboratoires publics ou privés.

Spectroscopic, pressure and temperature measurements of the reactant mixing process in sodium-water reaction

Lucas David^{a,b}, Mirjana Milanovic^c, Phillippe Hervé^c, Yannick Bailly^d, David Ramel^d, François Beauchamp^{a,*}, Alexandre Allou^a

^a LTPS, CEA Cadarache, 13108 Saint Paul-lez-Durance, France

^b LMA, Aix-Marseille Université, CNRS, Centrale Marseille, Marseille, France

^c LEME, Université Paris-Nanterre, 92410 Ville d'Avray, France

^d Institut FEMTO-ST, Université de Franche-Comté, 90000 Belfort, France

* Corresponding author: francois.beauchamp@cea.fr

Abstract

The reaction of sodium metal with water is a heterogeneous, exothermic reaction known to be prone to runaway with explosive effects when uncontrolled. The occurrence of runaways requires the reactants to be effectively mixed which is not the case initially for sodium and water. The latter are put in contact in two distinct, condensed phases, that are moreover rapidly separated by a gaseous film generated by the reaction itself. The runaway is triggered by a reactant mixing process that is not elucidated. This mixing could occur either in liquid or gas-phase. In this paper, we investigate the mixing process of sodium-water reaction in the small scale configuration of 1-4g sodium pellets with excess water in a closed vessel, using time-resolved video, optical, pressure and temperature acquisitions. The results show that sodium vaporization is implicated in the reaction and that it is generated in great quantity during runaway. However it appears from temperature measurements that boiling temperature is not reached in the sodium before runaway or only locally. It is therefore possible that reactant mixing occurs in the gas phase if an intensification of sodium vaporization takes place as a fast local transient. The possibility of reactant mixing in liquid phase is not contradicted by these results but was not identified from the available videos and data.

Keywords: sodium-water reaction; heterogeneous reaction; runaway; spectroscopy

1. Introduction

Sodium is considered as a coolant fluid for Fast-neutron Reactors (SFR) because of its excellent neutronic properties and heat-transport capability. As a strongly reducing element, on the other hand, it has a high chemical reactivity with common materials such as oxygen or water. Its use therefore requires the control of the risks associated with its potential reactions at all stages of SFR operation. This is why much research has been conducted on sodium reactions since the development of the SFR concept in the 1950s [1], [2].

In spite of that effort, the fine-scale process of sodium-water reaction (SWR) is not yet fully understood today, and keeps being investigated [3]–[6]. SWR is known to form sodium hydroxide and hydrogen as per the exothermic equation:

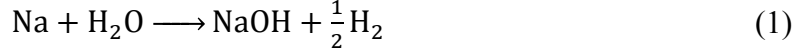

Its fine-scale processes, and in particular the mechanism leading to an eventual explosive runaway, are still to be modeled. As it has been demonstrated that the runaway can occur under inert atmosphere [3], the explanation of hydrogen combustion is ruled out. SWR therefore proceeds by the sole interaction of sodium metal with water. As such, it is a heterogeneous process: the reaction takes place at an interface. For the reaction to become explosive, reactants must get effectively mixed, and it is not clear how this mixing is achieved.

Mason et al. [5] proposed a mechanism for reactant mixing in liquid phase. By studying the interaction of a 100 mg drop of sodium-potassium alloy (NaK) with water, they observed that metal spikes appeared around the drop immediately onto contact. They explain that electrons from the metal dissolve in water, which causes positive charge accumulation and electrostatic repulsion in the metal, resulting in deformation of its surface with spikes. The mixing of reactants is then achieved by the exponential increase of their contact surface.

This phenomenon was however not observed at larger scales or with initially solid alkali metals such as sodium at room temperature. In such case, runaway does not occur immediately but after a variable delay time after contact of the reactants. During this delay time, a gaseous layer separates sodium and water, and what causes its destabilization and sudden onset of a runaway is not identified.

In a previous work [7], on the basis of a small-scale, open-atmosphere experiment and of a simplified SWR model, we suggested that reactant mixing could also occur in the gas phase. In this mechanism, sodium is heated near boiling temperature by the reaction. It is then unable to absorb any more energy and starts vaporizing massively, which results in mixing of sodium and water vapors, enabling runaway. This mechanism was also simulated numerically and proved to be able to reproduce experimental observations, such as the generation of shock waves [8].

In this paper, we present an experiment conducted to investigate SWR reactant mixing mechanism and runaway process. The experimental layout is designed to facilitate repeatable test conditions and data acquisition. Tests consist in interactions of small spherical samples of sodium (1 to 4 g) with excess water in a close vessel. 87 tests have been carried out with 3 variable parameters: sodium mass, water temperature and water volume. The reaction is monitored with pressure and temperature sensors, spectrographic measurements, and a high-speed camera.

The experimental setup is presented in Section 2. The following sections report images and measurements acquired, as well as their exploitation. Finally, a discussion about SWR mechanism is proposed in Section 8.

2. Experimental layout, procedure and measurements

2.1. Experimental apparatus

The experimental device used consists of a 3.5 L stainless steel reactor and a sodium insertion system (Fig. 1). The reactor is made of stainless steel and has 3 $\text{\O}50$ mm portholes every 90° . It is designed for an operating pressure of 16 bar and protected by a safety valve. The removable insertion system is constituted of a cylindrical housing, a manual closing valve, a pneumatic cylinder and an extension rod, at the end of which the sodium sample is placed in a steel basket. A pneumatic valve also ensures physical separation of the reactants outside the test phases. The reactor is connected to an argon inlet for inerting and to a vent for evacuating reaction gases.

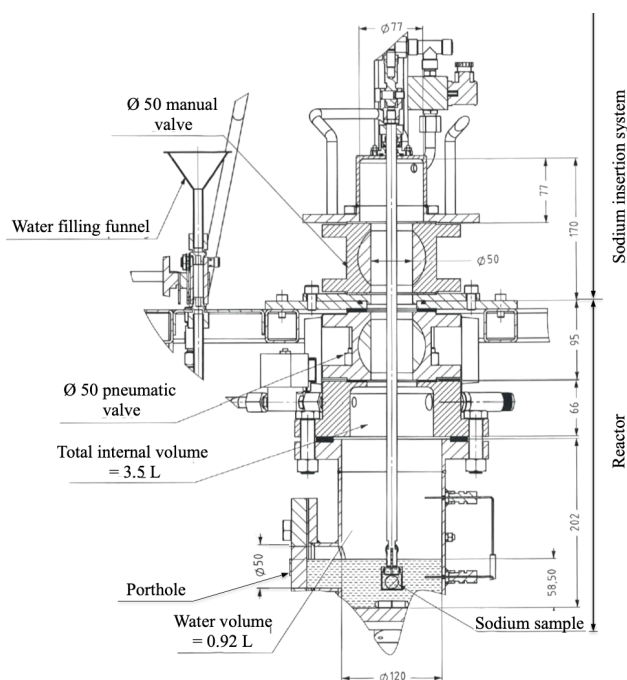

Fig. 1: the experimental apparatus consists of a 3.5 L cylindrical reactor with 3 portholes. The sodium sample is placed in a basket and introduced in the water by the translation of a pneumatic cylinder.

2.2. Experimental procedure

Each test is conducted as follows:

- A sodium spherical pellet is prepared under inert atmosphere in a glove box;
- The sample is introduced in a basket which is screwed at the end of the rod of the insertion system;
- The rod is pulled up and the manual valve closed, so that the sample is kept under inert atmosphere inside the housing compartment of the insertion system;
- The insertion system is removed from the glove box and mounted back onto the reactor;
- A volume between 700 and 1100 mL of water is inserted in the reactor via the filling funnel;
- The reactor is inerted with argon;
- Both manual and pneumatic valve are opened;
- The cylinder descends to plunge the sodium into water. When the cylinder reaches its lower position, an optical sensor triggers the start of measurement acquisition. The basket is then at the height of the portholes;
- Once the reaction is complete, reaction gases are vented out and water containing soda is flushed.

Sodium samples masses are comprised between 1.0 and 4.0g, with a tolerance of ± 0.05 g for

masses strictly inferior to 2g and ± 0.1 g above. Water volumes are sampled with a graduated cylinder with an uncertainty of ± 10 mL.

2.3. Measurements

Optical measurements are made through the portholes and temperature and pressure measurements are taken inside the reactor. All acquisitions are synchronized using an optical trigger system. The specific characteristics of each acquisition are detailed hereafter.

- **Imaging.** Videos are recorded with a Phantom v411 high-frequency digital camera mounted with a Nikon 18-70 f2.8 macro lens, mostly used at speeds about 6000 frames per second (fps).
- **Spectroscopy.** Optical spectra are acquired with a Horiba Micro-HR spectrometer with a frequency of 60 Hz with 1400 wavelength bins and an accuracy of ± 0.5 nm. Signals are corrected to account for the absorption by the water layer crossed.
- **Luminance measurements (photomultiplier).** Luminance measurements for sodium vapor are acquired with a photomultiplier connected to an impulsion counter and acquired at 80 Hz. Sodium vapor Na-D lines (589-589.6 nm) are isolated using a Thorlabs FB590-10 filter.
- **Thermometers.** The reactor is instrumented with 2 $\varnothing 1$ mm type K sheathed thermocouples (one in the water and one in the gaseous atmosphere, see Fig. 1). These thermocouples are used mainly for control purposes (water temperature control) but their temperatures are also acquired synchronously with other data from test 54. For 24 tests, $\varnothing 0.2$ mm type K unsheathed thermocouple is also placed at the core of the sodium sample (inserted into a needle-drilled hole, see Fig. 6).
- **Pressure.** Pressure is measured by an Endevco model 8530B piezoresistive transducer with a 0-34 bar range, acquired at 20 kHz. The sensor is placed inside the reactor 20 cm away from the sodium sample.

3. High-speed video observations

The reaction is filmed with a high-speed camera placed in the central porthole, while illumination is provided by 2 green LEDs with collimators producing a parallel beam from both sides. Fig. 2 presents images for a sample test filmed at 6000 fps. The first images show that there is a short delay between the penetration of the sodium in the water and the apparition of the first effects of SWR. It takes about 100 ms before the first small hydrogen bubbles are generated. Bubbles then rapidly become more abundant and bigger. After about 1s they coalesce into a gas-film, from which other bubbles escape through the openings of the basket. At this time the sodium is generally melted, which indicates that its temperature is greater than 98°C. The gas film seems continuous, however it is bubbly and its thickness is irregular, so it is not excluded that liquid-liquid contacts locally occur. No noticeable change is visible afterwards until runaway. The runaway is very sudden and is triggered within less than 1 ms. It is characterized by a rapid expansion of the gas film. An ignition is generally visible producing an orange luminous flash, accompanied by the acceleration of gas expansion. The expansion of the reaction gases next completely obscures the vision for about 1s. This is attributed both to the repulsion of the gas-water interface, which reflects the lighting out of the field of vision, and to the presence of opaque gases and particles such as sodium vapor or sodium hydroxide which absorb light in the gas phase. It is only when repelled water falls back and the hydroxide dissolves that the empty basket becomes visible again.

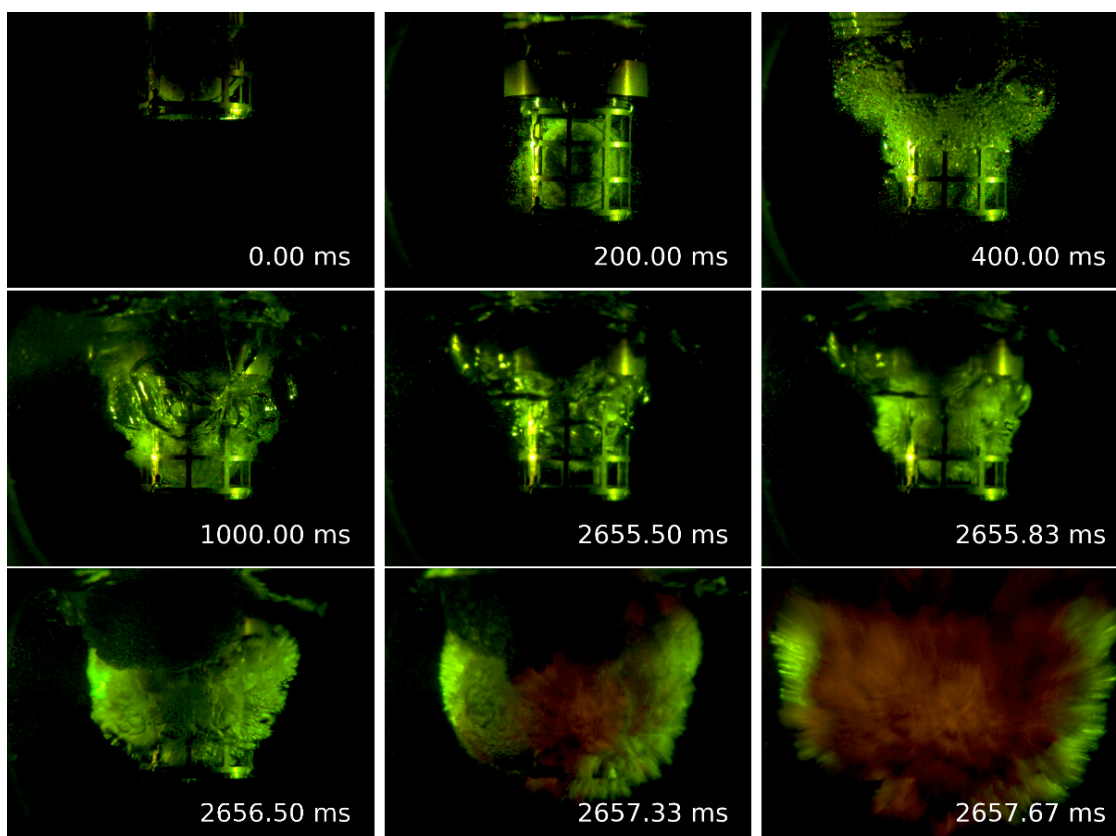

Fig. 2: selected snapshots from high-speed video of SWR experiment filmed at 6000 fps. The reaction is illuminated from both sides with 2 collimated LEDs centered on $\lambda=565\text{nm}$

4. Spectroscopy

Spectroscopy is used for tests 35 to 47, mainly in the 400 – 700 nm and 700 nm – 1 000 nm ranges. It is used both to identify species present and to estimate the flame temperature using Planck's law. As the spectra exploited are acquired during the expanding bubble phase, it is estimated that light crosses a 3 cm thick water layer before reaching the spectroscope. Spectra therefore have been recalculated to reverse the effects of absorption by water (which are only significant in the red and infrared regions).

Typical spectra are shown in Fig. 3. During the delay time between reactant contact and runaway, the spectroscope records no signal above noise level. The light emission is indeed too low for the sensitivity of the spectroscope during this period, and was only detected by the photomultiplier (see Section 5). Comparison of the spectroscope signal intensity with the pressure signal in Fig. 3 shows that the exploited spectra correspond to the reaction in the expanding bubble following runaway, when spontaneous emissions are most intense.

The spectra consist in Na(v) emission lines on top of a continuous background (Fig. 3). The broadening and self-reversal of the Na-D lines (located at 589.0 and 589.6 nm) are clearly visible. The broadening is due to collisions between Na atoms. Line reversal is due to the very high absorption coefficient of sodium vapor at the Na-D wavelengths. These effects indicate a high sodium vapor pressure, and this pattern is typical of the High-Pressure Sodium (HPS) lamp spectrum [9]. Sodium vapor pressure in a HPS is generally between 7 and 40 kPa.

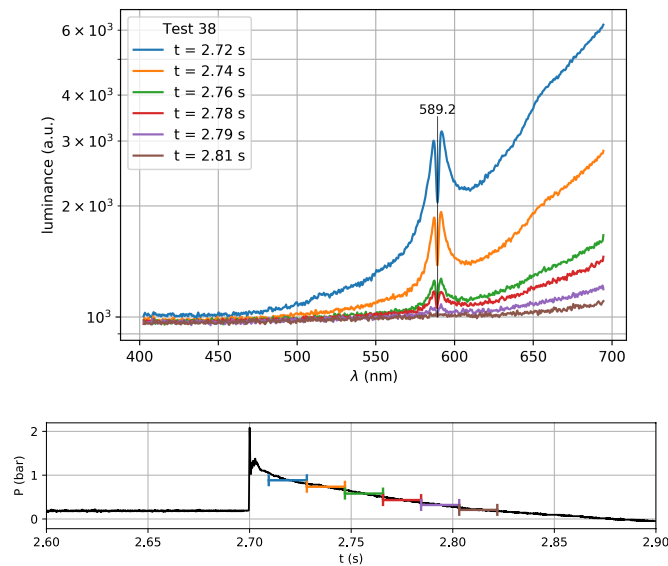

Fig. 3. Typical spectra recorded in the 400-700 range. The broadening and self-reversal of the Na-D lines (located at 589.0 and 589.6 nm) indicate a high sodium vapor pressure. The continuous background is reminiscent of Planck's law and used to compute estimations of the flame temperature. The acquisition time intervals are shown below with the pressure signal to give a time-reference of runaway.

Except for this pattern, the spectra are continuous and resemble that of a hot solid or liquid. Marfaing [10] has shown that the sodium hydroxide produced by SWR is mainly in the form of condensed particles. As liquid sodium metal and water have a low emissivity compared to NaOH and are at lower temperatures, it is likely that this continuous spectrum is due to NaOH emission in the reaction zones. Determining the temperature corresponding to that spectrum can therefore give an estimate of the flame temperature, *i.e.* the temperature in the hottest spots where the reaction takes place. The flame temperature is estimated by fitting Planck's law to the spectral distribution of the isolated continuous background, assuming that NaOH acts as a grey body. Details of this computation are presented in Appendix A. and results in Fig. 4. 66 spectra were fitted in the 12 tests with spectroscopy. Temperature estimations are mostly located in the 1200 – 1650 K region. This is consistent with the limit of sodium hydroxide vaporization temperature (1661 K). It has indeed been shown that SWR is not exothermic enough to produce sodium hydroxide in gaseous form [10].

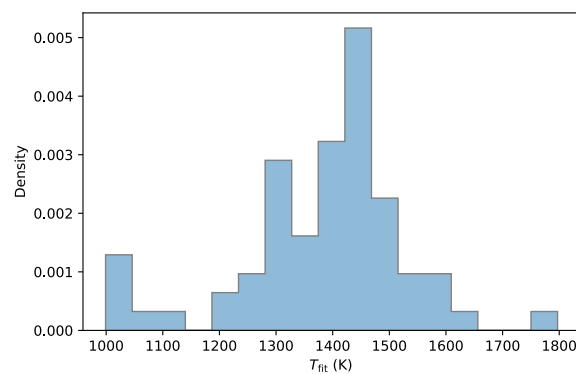

Fig. 4. Distribution of the flame temperature estimations

5. Photomultiplier (Sodium vapor)

Luminance at $\lambda=589$ nm, characteristic of the sodium vapor Na-D lines, is acquired with higher sensitivity by a photon-counter photomultiplier. Photons are filtered using a band-pass filter centered at 590 nm with a 10 nm width. Sample results are shown in Fig. 5. It is clear that the amount of sodium vapor gradually increases during the delay time and that sodium vapor remains present and reacting in the expanding bubble for several seconds after explosion. Also, it is a systematic observation that runaway is triggered when the PM signal is about 10^5 u.a.. This accredits the hypothesis that SWR runaway could be triggered by a sufficient level of sodium vaporization, as developed in reference [7]. Low values visible on Fig. 5 after runaway are due to detector saturation and on the contrary signify a high luminance value. This shows that sodium vapor is particularly abundant after runaway, as also demonstrated by spectroscopic analysis in Section 4, and for an especially long duration when pressure peak is not very steep (small explosion, *e.g.*, Fig. 5 test 47). These measurements also concur with observations made during previous SWR small-scale experiments in open atmosphere [7].

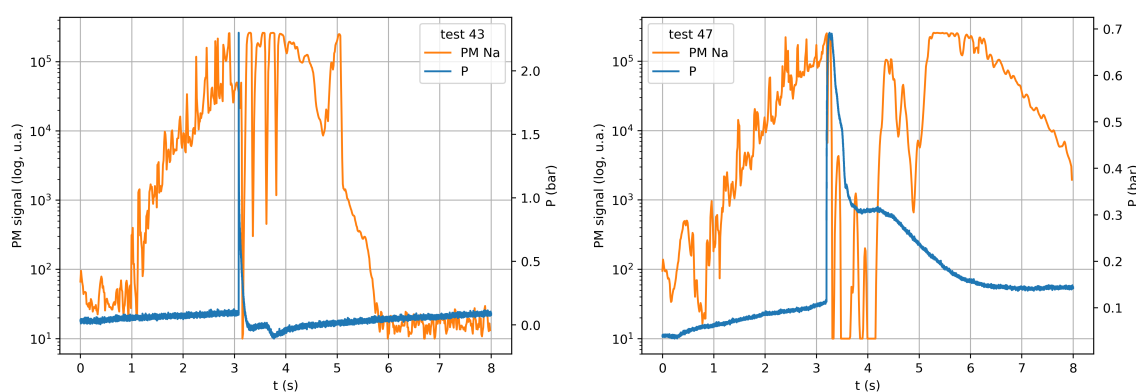

Fig. 5. Photomultiplier signals at $\lambda=589$ nm shows a clear increase in sodium vapor production before runaway, and abundance of sodium vapor following pressure peak causing saturation of the detector

6. Internal temperature

Sodium internal temperature is measured by a $\varnothing 0.2$ mm type K unsheathed thermocouple. For this acquisition, a hole is pierced in the sodium pellet with a needle, and the thermocouple inserted into it (Fig. 6). The connection between the thermocouple and the acquisition system is made through the inside of the translating rod of the insertion system, so that it is not perturbed by the action of the cylinder.

The measure is local, but sodium has a very high thermal diffusivity ($D \approx 7 \times 10^{-5} \text{ m}^2/\text{s}$ [11]), and the thermal diffusion time in a typical 2g sodium pellet with radius $R=8.5$ mm can be estimated to $R^2/D=1\text{s}$. At the time scale considered sodium temperature is therefore expected to be nearly uniform except for fast transients.

Example signals are shown on Fig. 7. It can be seen that sodium progressively heats up from ambient temperature to about 250°C . On some signals such as for test 44, the melting point at 98°C is clearly visible. A steep temperature peak is measured during explosion, simultaneously with the pressure peak. The peak temperatures measured are not quantitatively exploited, as the peak is shorter than the response time of the measurement (estimated to 25 ms), and the runaway perturbs the measure. We rather look at the temperature T_l preceding runaway, which is calculated as the average of the values of the signal, denoised using a Savitzky-Golay filter, in the 25 ms before the peak. It is found that 21 of 24 acquired values of T_l are located between 190 and 280°C , with an average of 239°C ,

regardless of the sodium mass. Even though there can be small differences between the measurement and the real sodium internal temperature, due to non-optimal wetting of the thermocouple by sodium, these values show that sodium is far from boiling temperature at the onset of runaway.

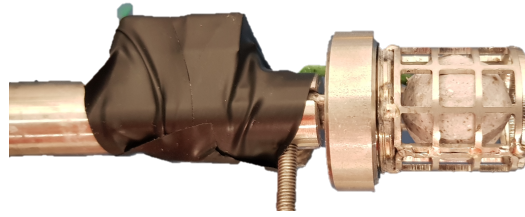

Fig. 6. Sodium internal temperature is measured by an unsheathed thermocouple directly inserted into the pellet. The compensation cable runs inside the translating rod of the insertion system

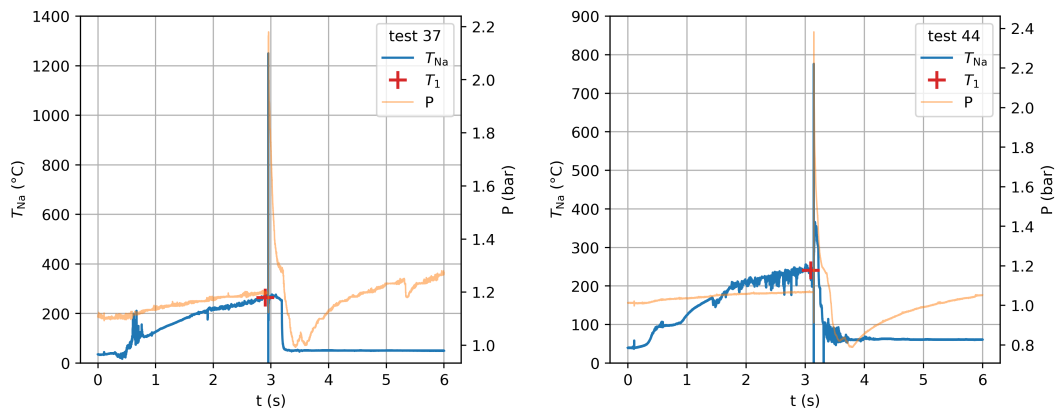

Fig. 7. Example signals for sodium internal temperature measurements by thermocouple. Temperature increases from ambient to about 250°C before the explosive runaway, characterized by a peak in both temperature and pressure.

7. Pressure

Pressure signals are acquired for most tests. Else than giving an image of the pressure inside the reactor, they are used to measure the delay time, that is the time between contact and explosion, and to evaluate the rate of sodium consumption.

A typical pressure signal is represented Fig. 8. Pressure signals are generally characterized by a slow pressure increase due to hydrogen liberation during the delay time, and then a stiff peak at runaway. The rise time is about 0.5 ms. The shape of the signal is reminiscent of that of the shock wave, though we cannot positively characterize it as such with available data.

The measured values of peak overpressures $\Delta P_{max} = P_{max} - P_0$ are globally quite scattered, even with repeatable experimental test conditions. Possible explanations for that dispersion are either the deformation of the pressure wave by the sodium-holding basket, or too low acquisition frequency (20 kHz) that might clip the signal. SWR itself is moreover known to be highly irregular in nature [4], [6]. Nevertheless, it is still clear that overpressures are globally increasing with sodium mass (Fig. 9).

Pressure signals are also used to compute the delay time, *i.e.* the time between contact of the reactants and runaway. Numerically, the delay time is computed as the time of the pressure maximum or alternatively the maximum of the pressure gradient, when the peak is not steep enough. The delay time is found to be decreasing as water temperature is increased. This observation concurs with results of previous similar SWR experiments, carried out with 1g sodium pellets in excess water and in an open environment [7].

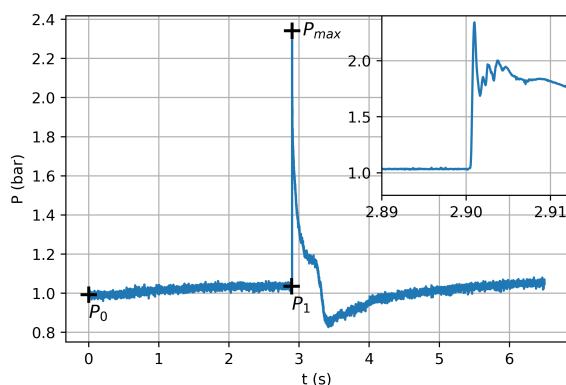

Fig. 8. Typical raw pressure signal (test 53) with a close-up on the pressure peak. The points P_0 , P_1 , and P_{max} represented are respectively the initial pressure, the pressure before runaway, and the peak pressure

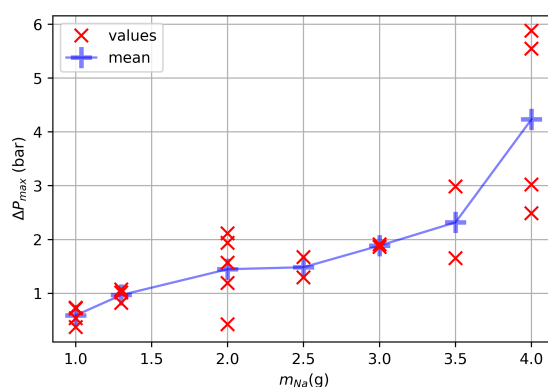

Fig. 9. Maximum overpressures recorded for tests at $40\pm 5^\circ\text{C}$. Water volume is 920 mL. The values are rather scattered even with repeated test parameters, but average values are globally increasing with sodium mass

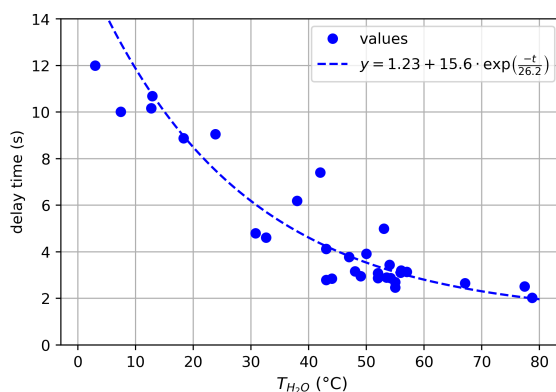

Fig. 10. Delay time (*i.e.* time between contact of the reagents and explosion) for tests with $m_{Na}=2\text{g}$ and $V_{H_2O}=920\text{ mL}$. The delay time is found to be decreasing with water temperature, as in reference [7]

Pressure signals are also used to estimate the fraction of sodium consumed before the runaway and the reaction rate (rate of sodium consumption). Under the assumptions that the pressure rise before runaway is solely due to hydrogen generation, and that the temperature variation in the reactor atmosphere is negligible (which is confirmed by thermocouple measurements), the pressure variation can be linked to the mass of sodium consumed by the

ideal gas equation of state:

$$\Delta m_{Na} = \frac{2M_{Na}V\Delta P}{RT_{gas}}$$

where $\Delta P = P_f - P_0$ is the difference between the pressure before explosion and at initial state (see Fig. 8), $V = (3.5 \text{ L} - V_{H_2O})$ is the reactor volume available to gas, T_{gas} the gas temperature, R the universal gas constant, and M_{Na} sodium molar mass. It is found that in average between 7 and 25% of the sodium mass is burnt before runaway.

Average reaction rates $\dot{\omega}$ can be estimated by dividing the quantity of sodium burnt during heating by the delay time t_d and the pellet external surface S_0 :

$$\dot{\omega} = \frac{\Delta m_{Na}}{M_{Na}t_d S_0}$$

Values of $\dot{\omega}$, shown in Fig. 11, are mostly comprised between 1 and 10 $\text{mol}\cdot\text{m}^{-2}\cdot\text{s}^{-1}$, which is globally in line with earlier estimations by Ashworth (6-25 $\text{mol}\cdot\text{m}^{-2}\cdot\text{s}^{-1}$) [2], Carnevali (10 $\text{mol}\cdot\text{m}^{-2}\cdot\text{s}^{-1}$) [6] and Marfaing (2.2 $\text{mol}\cdot\text{m}^{-2}\cdot\text{s}^{-1}$) [10]. The reaction rate increases with water temperature, as also established by Ashworth.

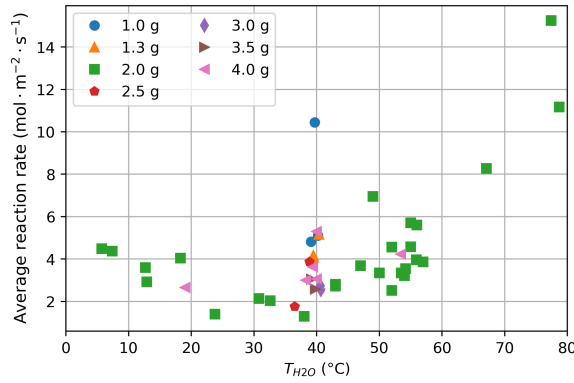

Fig. 11. Estimation of the reaction rate from Δm_{Na} . Values increase with water temperature from 30°C but do not seem to depend on sodium initial mass and are in agreement with data obtained by Ashworth [2]

8. Discussion

In this experiment, we performed high-frequency imaging and data acquisition on SWR at a small scale, in the purpose of uncovering the process of its runaway. As stated in introduction, and also identified by other authors [4], [5], the key to the onset of SWR runaway is reactant mixing, which turns SWR into a homogeneous reaction and allows for the reaction rate to jump exponentially. Two hypotheses have been proposed to explain reactant mixing: a mixing in liquid-phase [5], due to an electrostatic instability which leads to fragmentation of the sodium drop, or a mixing in gas-phase [7], [8], caused by vaporization of the reactants after their heating by the slower heterogeneous reaction.

Concerning the mechanism of gas-phase reactant mixing, the optical measures acquired with the photomultiplier prove the presence of sodium vapor in increasing quantity towards runaway. During explosions, the spectroscopy indicates a high sodium vapor concentration. These measures are consistent with this mechanism that requires the vaporization of both reactants. Moreover, the exponential decrease of delay times and the increase of reaction rate with the water temperature also tend to support this hypothesis for the following reason. In the gas-phase mixing mechanism, before vaporizing, the sodium is first heated by a surface reaction with water vapor diffusing through the gas-film [7]. Water vapor pressure is an exponential function of its temperature. Therefore, the hotter the water, the more steam there is in the gas film, resulting in an increase in reaction rate, faster heating of sodium and shorter

delay times. However, the temperatures measured in the sodium are low compared to its boiling temperature (883°C), even in the milliseconds preceding runaway. At 240°C, which is the average sodium temperature measured before runaway, the sodium vapor pressure is about 1 Pa [11]. This is far too low to obtain a mixture of reactants with a sufficient concentration to produce the explosions observed. Note that these rather low temperatures are not contradictory with the optical detection of sodium vapor emissions, as they are in fact about the operating temperature of a low-pressure sodium lamp (typically 260°C). The temperature measurements suggest that if the reactants are mixed with the gas-phase mechanism, the latter is a local transient occurring faster than thermal diffusion in the sodium drop.

On the other hand, regarding the mechanism of reactant mixing in liquid phase, the present experiment cannot confirm or exclude this hypothesis. The electrostatic instability potentially leading to fragmentation of the liquid metal drop as proposed by Mason et al. [5] would occur at its surface. Unfortunately the sodium surface cannot be seen clearly through the bubbles in the videos. This phenomenon therefore cannot be identified in this configuration. However, the temperature measured in the sodium shows that it is liquid but rather far from boiling temperature at runaway onset. In this temperature range, it is therefore most likely that mixing occurs in liquid phase, except in the case of a fast local vaporization as explained previously.

Further experiments are envisioned to discriminate between these two hypotheses. In particular, the following tests could provide decisive insights:

- Acquire high-speed videos of SWR in a transparent vessel of thin rectangular section. This would allow the gas film to expand in only one direction, as it would reach the wall in the other direction (the width) of the rectangle. We would therefore be able to visualize what occurs within the film and hopefully the mechanism of reactants mixing, whether in gas or liquid phase. This method was also used for the study of thermal fragmentation in the context of steam explosions [12];
- Measure the electrical potential in the liquid metal during the reaction. Indeed, the calculation of the Rayleigh instability criterion [13] shows that the charge required to fragment a 1g liquid sodium drop by a Coulomb explosion is about 10^{-8} C, and corresponds to a potential of about 20kV. Whether such a high potential is measured in the metal would therefore allow concluding about the hypothesis of electrostatic fragmentation and reactant mixing in liquid-phase.

Conclusion

An experiment was carried out to investigate the enigmatic process of reactant mixing during sodium-water reaction. The acquisitions performed during the 87 tests provide new insights in the rapid, fine scale mechanisms involved. High-speed videos show that the runaway is triggered within 0.1 ms and is characterized by the fast expansion of the gas film that ignites in an orange flash. Optical measures reveal that sodium vapor is implicated in the reaction, and in particular it is generated in high quantities during explosions. Also this experiment confirms that the reaction is accelerated for elevated water temperatures, which is likely due to the abundance of water vapor implicated in the heterogeneous phase of the reaction. Finally the measured temperatures in sodium at runaway were in the liquid range of sodium, far from boiling temperature. Unfortunately, it cannot be concluded at this point which of the two hypotheses formulated for mixing of sodium and water (in liquid or in gas-phase) is at the origin of runaway. Results show that if runaway is triggered in the gas-phase it must be local and fast. If the mixing occurs in liquid phase it is also hardly visible in the videos in this configuration. Further experiments are proposed which, combined with the present results, are expected to provide conclusive answers about the runaway.

Acknowledgements

This work was funded by the French Alternative Energies and Atomic Energy Commission (CEA).

References

- [1] C. C. Addison, "The chemistry of the liquid alkali metals," Jan. 1984.
- [2] A. B. Ashworth, "Reactions between the liquid alkali-metals and liquid water," PhD Thesis, University of Nottingham, 1979.
- [3] S. Carnevali, C. Proust, and M. Soucille, "Unsteady aspects of sodium-water-air reaction," no. 91, pp. 633–639, 2013.
- [4] K. Daudin, F. Beauchamp, and C. Proust, "Phenomenological study of the pre-mixing step of sodium-water explosive interaction," *Exp. Therm. Fluid Sci.*, vol. 91, pp. 1–8, Feb. 2018.
- [5] P. E. Mason, F. Uhlig, V. Vaněk, T. Buttersack, S. Bauerecker, and P. Jungwirth, "Coulomb explosion during the early stages of the reaction of alkali metals with water," *Nat. Chem.*, vol. 7, no. 3, pp. 250–254, Mar. 2015.
- [6] S. Carnevali, "Unsteady aspects of sodium-water reaction: water cleaning of sodium containing equipments," UTC-CEA, 2012.
- [7] L. David, F. Beauchamp, A. Allou, R. Saurel, P. Guiffard, and K. Daudin, "A small scale experiment and a simplified model to investigate the runaway of sodium-water reaction," *Int. J. Heat Mass Transf.*, vol. 144, 2019.
- [8] D. Furfaro, R. Saurel, L. David, and F. Beauchamp, "Towards sodium combustion modelling with liquid water," *Submitt. Publ.*, Mar. 2019.
- [9] J. J. De Groot, J. A. J. M. van Vliet, and J. H. Waszing, "The high pressure sodium lamp," *Phillips tech. Rev.*, vol. 11, no. 35, pp. 334–342, 1975.
- [10] O. Marfaing, "Contributions to the fine-scale modeling of sodium-water reaction," Universite Paris VI; CEA, DEN-DM2S (France), 2014.
- [11] J. K. Fink and L. Leibowitz, "Thermodynamic and transport properties of sodium liquid and vapor," Argonne National Lab., ANL--RE-95/2, 1995.
- [12] Y. Zhou, M. Lin, M. Zhong, X. Yan, and Y. Yang, "Molten metal and water direct contact interaction research – I. Photographic experiment study," *Ann. Nucl. Energy*, vol. 70, pp. 248–255, Aug. 2014.
- [13] L. R. F.R.S, "XX. On the equilibrium of liquid conducting masses charged with electricity," *Lond. Edinb. Dublin Philos. Mag. J. Sci.*, vol. 14, no. 87, pp. 184–186, Sep. 1882.

Appendix A. Method for estimating the flame temperature

We estimate the flame temperature by fitting Planck's law on the continuous background of recorded spectra. To do so we assume that this continuous spectrum is generated by liquid species (sodium hydroxide particles) in the hottest spots (reaction zones), and that the emissivity factor is independent of wavelength (grey body assumption).

The spectral radiance of a hot liquid is a function of temperature and wavelength given by Planck's law:

$$B_{\lambda}(\lambda, T) = \varepsilon \frac{2hc^2}{\lambda^5} \frac{1}{\exp\left(\frac{hc}{\lambda k_B T}\right) - 1}$$

By fitting such function on the recorded spectrum, we can therefore have an estimate of the temperature T . We define a function f by:

$$f(\lambda, T) = a + b \frac{2hc^2}{\lambda^5} \frac{1}{\exp\left(\frac{hc}{\lambda k_B T}\right) - 1}$$

where a and b are renormalization parameters, accounting for the background noise, the fraction of the signal recovered by the spectroscope and the emissivity. For each spectrum, the method to estimate the flame temperature is the following (see Fig. 12):

- Isolate the continuous spectrum by cutting the part of the signal due to specific lines, and replacing it with a third degree polynomial interpolation of the neighboring points,
- Fit parameters a , b , and T of function f by the least squares method to recover the spectral distribution. The fitted T is the estimated temperature T_{fit} .

Results are presented in Fig. 4.

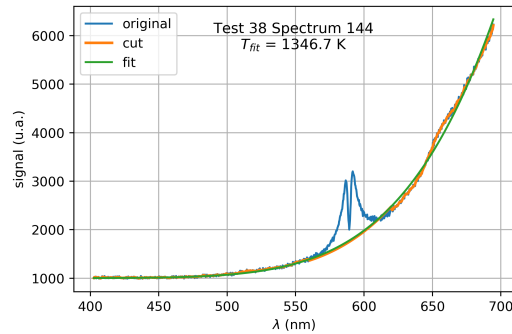

Fig. 12. Method for estimating the flame temperature by fitting a Planck's law-like function on a spectrum.