



**HAL**  
open science

## Preliminary study of the LORELEI test device with the CATHARE-2 code

P. Battistoni, M. Sumini, S. Manservisi, M. Di Giuli, C. Gonnier, L. Ferry, D. Tarabelli

### ► To cite this version:

P. Battistoni, M. Sumini, S. Manservisi, M. Di Giuli, C. Gonnier, et al.. Preliminary study of the LORELEI test device with the CATHARE-2 code. NENE 2015 - 24th International Conference Nuclear Energy for New Europe, Sep 2015, Portoroz, Slovenia. cea-02509718

**HAL Id: cea-02509718**

**<https://cea.hal.science/cea-02509718>**

Submitted on 17 Mar 2020

**HAL** is a multi-disciplinary open access archive for the deposit and dissemination of scientific research documents, whether they are published or not. The documents may come from teaching and research institutions in France or abroad, or from public or private research centers.

L'archive ouverte pluridisciplinaire **HAL**, est destinée au dépôt et à la diffusion de documents scientifiques de niveau recherche, publiés ou non, émanant des établissements d'enseignement et de recherche français ou étrangers, des laboratoires publics ou privés.

## Preliminary study of the LORELEI test device with the CATHARE-2 code

**Paolo Battistoni**<sup>1,2</sup>

paolo.battistoni2@unibo.it

**M.Sumini**<sup>1</sup>, **S.Manservigi**<sup>1</sup>, **M. Di Giuli**<sup>1</sup>, **C. Gonnier**<sup>2</sup>, **L. Ferry**<sup>2</sup>, **D.Tarabelli**<sup>2</sup>

<sup>1</sup>Industrial Engineering Dept., University of Bologna Via dei Colli 16  
40136, Bologna, Italy

marco.sumini@unibo.it, sandro.manservigi@unibo.it, mircodigiuli@libero.it

<sup>2</sup>CEA/DER/SRJH Cadarache 13115, Saint-Paul-lès-Durance, France  
christian.gonnier@cea.fr, lionel.ferry@cea.fr, didier.tarabelli@cea.fr

### ABSTRACT

One of the main experimental equipment under construction within the Jules Horowitz Reactor is the LORELEI (Light water One Rod Equipment for LOCA Experimental Investigation). The aim of this test device is to study the thermomechanical behavior of the cladding and the fuel rod in order to determine the radiological consequences in the case of a Large Break LOCA (Loss-Of-Coolant Accident) accident. In order to design appropriately this device it is important to simulate its behavior in normal operation or in incidental and accidental situations by using a thermal-hydraulic two-phase flow software. In this paper, we present two different numerical tests corresponding to the two main working conditions of the LORELEI device. The first test simulates the working condition of the re-irradiation phase, when the device is filled with water and the fuel rod cooled in a natural convection loop. This test is thought to provide temperature profiles and velocities in the thermosiphon component, both in single and two phase regime, and to determine the power threshold needed to limits the thermosiphon working conditions. The second test, consecutive to the re-irradiation phase, reproduces the LOCA sequence with the device in a gas environment (steam, helium and hydrogen). For this case, where high temperatures occur, a new dedicated radiative heat transfer module is introduced. The objective of the simulation is to obtain representative thermal maps of all significative components from the beginning of the LOCA sequence up to the high temperature plateau. We perform CATHARE-2 computations and compare the results with CFD corresponding simulations.

### 1 INTRODUCTION

The aim of this work is to perform numerical simulations in order to determine the maximum "normal operating conditions" and analyze the behavior of the LORELEI test device under accidental conditions. The LORELEI facility is built to characterize new cladding materials and investigate specific phenomena such a possible fuel relocation. Especially after the Fukushima accident, the international interest has increased to evaluate some alternative cladding materials which could give important aspects and margins upon LOCA condition. The typical phases of a *large break LOCA* considered in this paper are summarized in Fig.1 [1].

The simulations are carried out with the two-phase flow code CATHARE-2, which is developed by the CEA (Commissariat à l'Energie Atomique), EDF (Electricité de France), Framatome-ANP (Advanced Nuclear Power) and the IRSN (Institut de Radioprotection et de Sûreté Nucléaire). The code solves the energy, mass and momentum equations for each phase with six principal variables: pressure, void fraction, liquid and gas enthalpy, liquid and gas velocity.

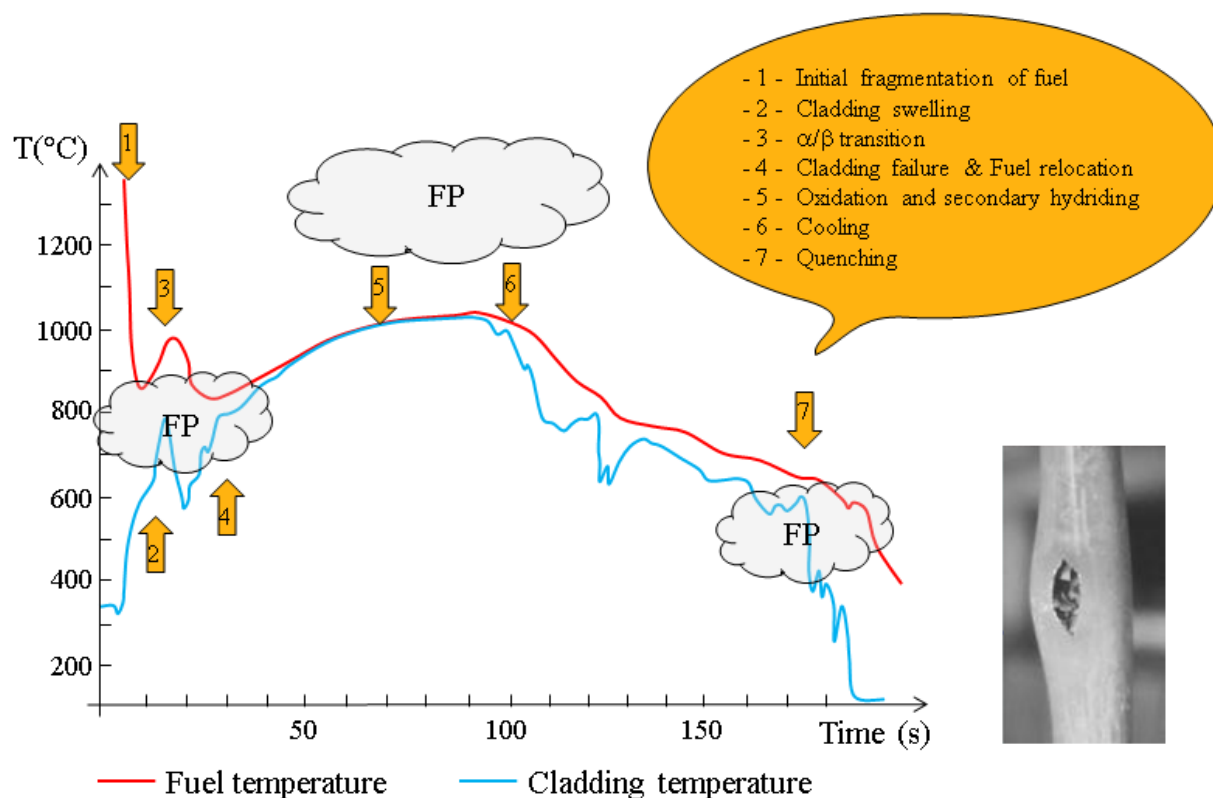

Figure 1: Different phases of a typical LOCA sequence.

## 2 LORELEI TEST DEVICE DESCRIPTION

The in-pile device has been designed to work as a closed capsule where the fuel rod is cooled in natural convection with a single phase thermosiphon circulating inside the device. The Fig.2 illustrates a simplified layout of the LORELEI in-pile parts. The device presents a change in diameter in the middle of its vertical axis: the lower part contains the fuel rod and it is inserted in the neutron flux core zone. The upper part, with the bigger diameter, is above the reactor core and plays the role of a heat exchanger where the power generated in the lower part is transferred to the cooling water surrounding the outer flask. There are two stainless steel flasks: the inner part is designed to withstand the internal pressure and the outer part forms the gas gap. The fuel sample is held by a sample holder at the center of the device. A flow separation tube is installed in the flask forming two concentric channels, a hot channel surrounding the fuel sample and a cold channel between the separator and the inner flask. Due to this flow separation tube, a thermosiphon flow can be formed ensuring the cooling of the fuel rod during the re-irradiation phase before the start of the LOCA transient. The gap between the device holder and the outer flask forms a cooling channel where the water coming from the pool flows in forced convection. A hafnium neutron screen will be used to flatten the axial flux.

The Fig.3 shows the LORELEI modeling using the graphic interface of CATHARE: three axial elements form the hot channel (HOT\_CH), the cold channel (COLD\_CH) and the cooling channel (COOL\_CH); two volume elements form the upper and the bottom part of the device, respectively VOLTOP and VOLBOT; BC\_COOL, BC\_OUT2, BC\_COO\_O and BC\_INLET are the boundary conditions imposed.

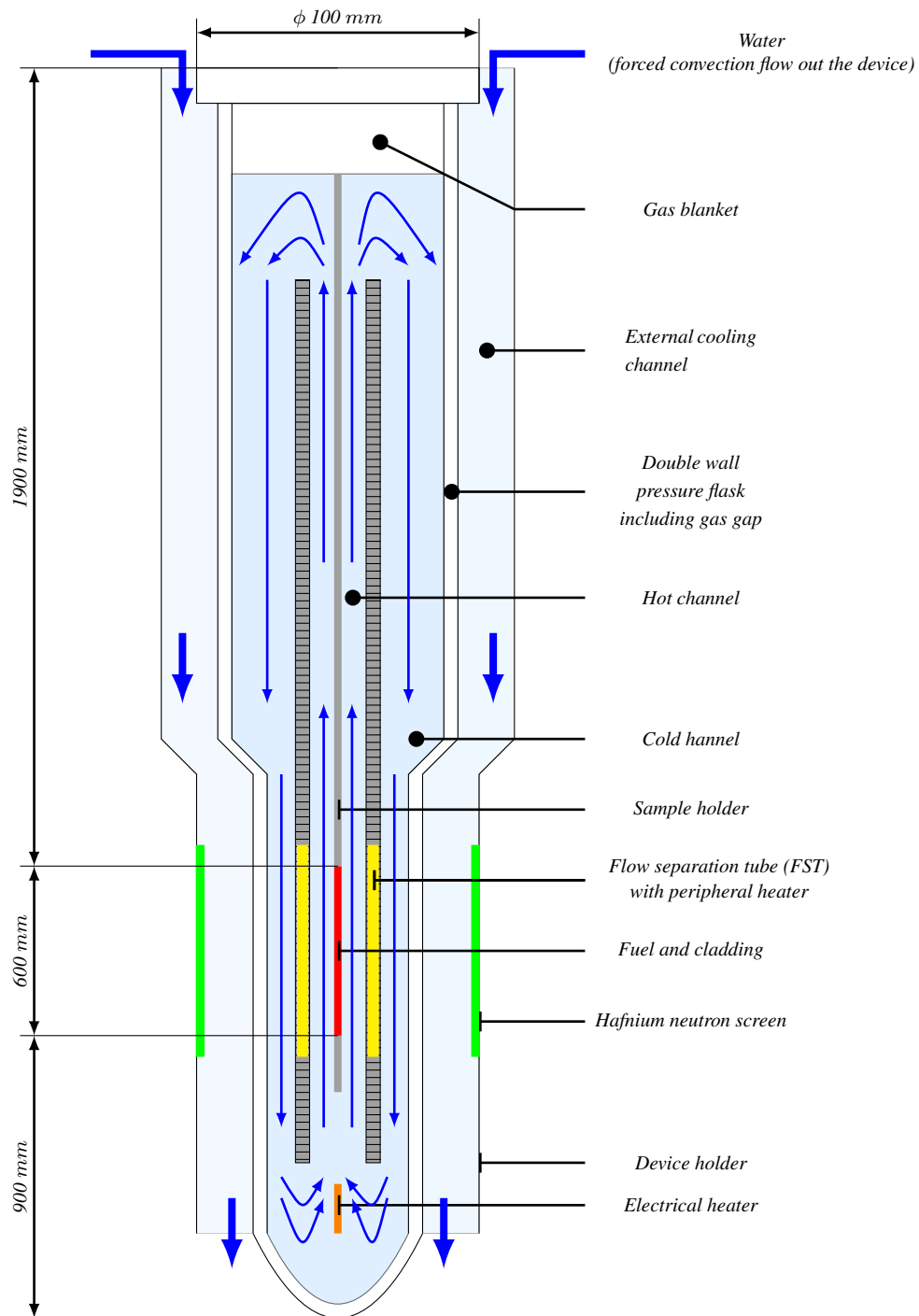

Figure 2: Simplified layout of LORELEI.

### 3 RE-IRRADIATION PHASE

The re-irradiation phase is the phase during which the fuel is re-irradiated for few days in order to generate short lived detectable fission products. The device is operated as a closed capsule and the fuel rod is cooled by natural convection with a single phase thermosiphon flow.

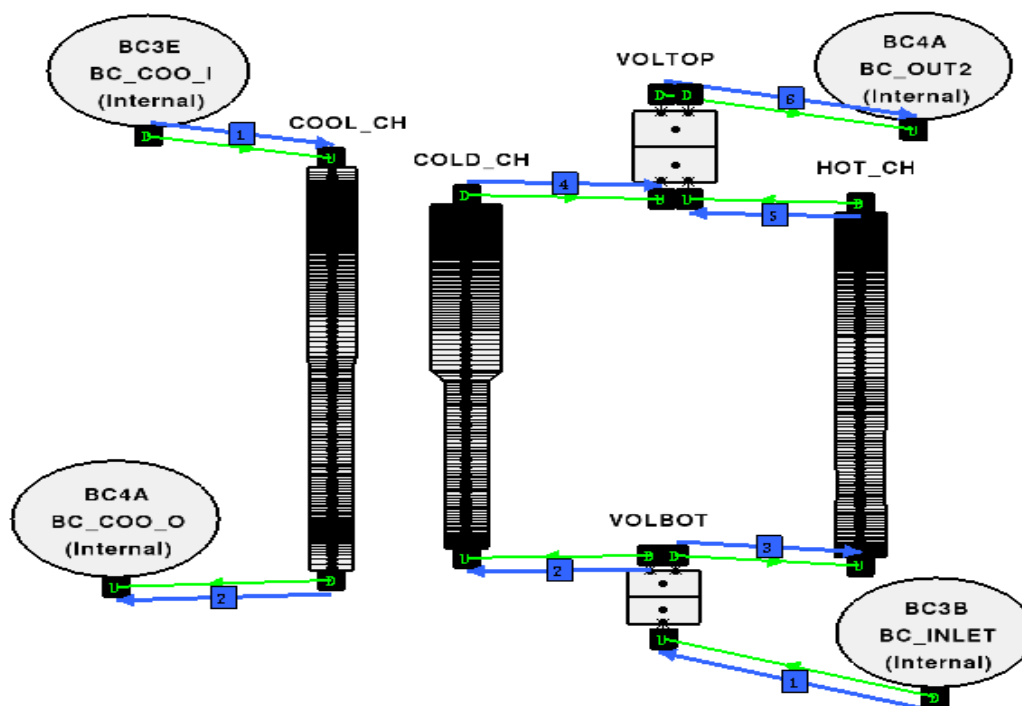

Figure 3: LORELEI modeling with CATHARE.

### 3.1 Nominal conditions

In nominal conditions the fuel sample is cooled by natural circulation, the internal pressure in the inner flask will be 70 bar. The nominal linear power per unit length of fuel (LHGR) is 30 W/cm.

To better understand the thermosiphon flow between the two channels one can see the Fig.4 which represents the liquid temperature inside the hot and cold channels:

**Hot channel:** starting from the bottom of the channel, the liquid starts to warm up at 0.5 m of height reaching a temperature of about 133 °C. From 1.3 m up to the end the liquid exchanges slightly with the cold channel coming out at 131°C.

**Cold channel:** starting from the top of the channel in the upper part ( $\phi_{cc}=70$  mm), the liquid exchanges with the cooling channel reaching a temperature of 113°C. From 1.3 m up to 0.5 m, due to the gamma radiation in the water, the liquid warms up to 129°C. In the last part of the channel the liquid exchanges again with the cooling channel at 126°C going out in the lower part of the cold channel ( $\phi_{cc}=58$  mm).

### 3.2 Accidental conditions

The aim of this simulation is to find the maximum power that inhibits the thermosiphon flow, in particular we are interested in determine the minimum distance from the reactor and hence the maximum LHGR.

The condition to terminate the thermosiphon flow between the two channels are not considered until we reach 240 W/cm. Only for LHGR, at about 250 W/cm, the upper part of the hot channel fills with steam (Fig.5). At this point the liquid mass flows inside the hot and cold channels vanish

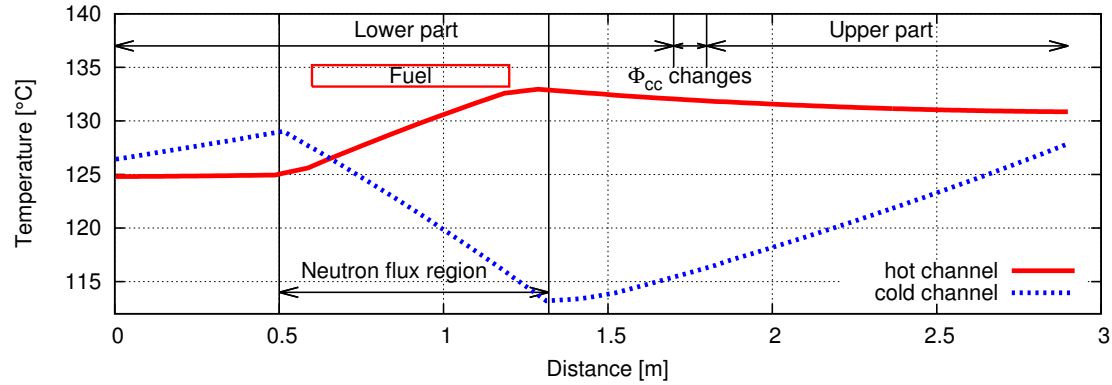

Figure 4: Liquid temperature along the hot and cold channels.

and the thermosiphon flow is stopped. In the Tab.1 we can see the liquid mass flow rate inside the hot channel.

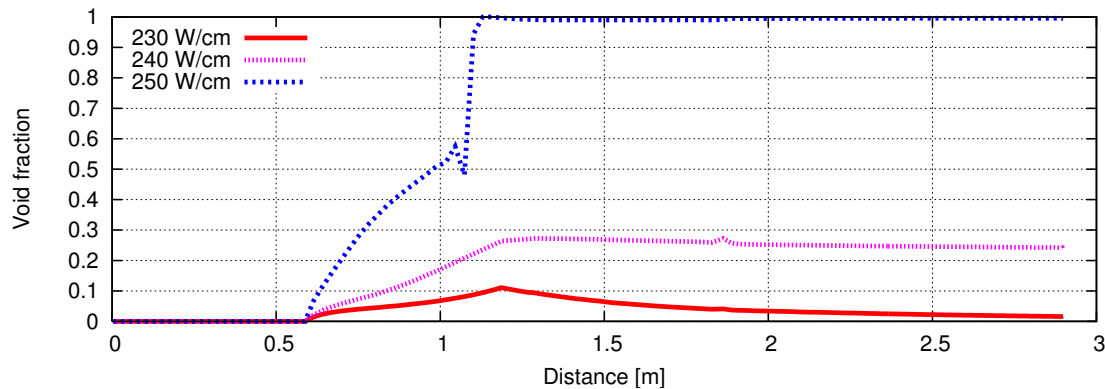

Figure 5: Void fraction inside the hot channel.

LGHR [ $W/cm$ ]	Mass flow [ $kg/s$ ]
230	0.2886
240	0.2496
250	0

Table 1: Conditions inside the hot channel.

#### 4 DRY PHASE

In this phase, the pressure inside the device is limited (around 5 *bar*). The aim of this study is to include radiative heat transfers through a special module to find the distribution of wall temperature [2]. This special module needs to be implemented because CATHARE does not compute the radiation between two different walls. Two simulations are performed: the first one, when there is only helium inside the device, and the second one, when also a mass of steam is produced in the bottom part of the device in order to provide a steam environment. The steam is generated by an electrical heater located at the bottom of the flask.

#### 4.1 Simulation with helium

The purpose of this simulation is to compare the results with CFD calculations in order to verify the proper functioning of our new radiation heat exchange model implemented on CATHARE. For this simulation we consider a linear power profile of about  $25 \text{ W/cm}$ . For the first 500 s from the beginning of the transient, the power is the 10 % of the nominal power and then up to the 62.6% in agreement with the distance from the reactor. The Fig.6 shows the wall surface temperature on the fuel and on the flow separation tube (FST) made by CATHARE and CFD calculation [3]. Along the fuel the temperature calculated by CFD varies from the  $1200^\circ\text{C}$ , in the center, to  $800^\circ\text{C}$  at the ends. The fuel temperature calculated by CATHARE is  $1100^\circ\text{C}$ . There are two main reasons about the difference between the two profiles of fuel temperature:

- 1) there is not an axial profile for fuel power in our CATHARE model;
- 2) in the CFD analysis the clad ballooning generates a peak in the center of the fuel and in the FST while in CATHARE calculation this behavior is not observed.

In the flow separation tube, the temperature calculated in the center by CATHARE is around  $900^\circ\text{C}$  in line with the maximum temperature calculated by CFD. As in the case of fuel, the axial profile of the gamma radiation in the CFD analysis generates a distribution of temperature quite different from the CATHARE calculation which is completely flat. The big differences between the two calculations in the upper and in the bottom part of the FST is entirely due to the fact that in our CATHARE modeling the FST was divided in three parts and CATHARE does not take into account the axial conduction between them. Also, the specific module that takes into account the radiation between the fuel and the FST is only activated along the entire length of the fuel and this explains the sharp variation of temperature at the ends of the central piece of the FST.

The Fig.7 shows the pressure inside the fuel gap and the external temperature of cladding. At temperature around  $830^\circ\text{C}$  the cladding burns and the pressure inside the gap decreases quickly.

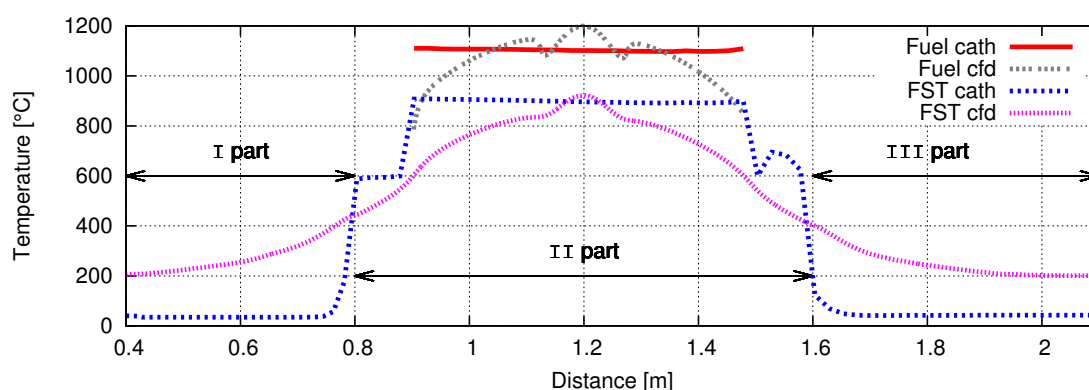

Figure 6: Wall temperature calculated with CATHARE and CFD.

#### 4.2 Simulation with helium and steam

In this simulation we want to investigate, in a very preliminary stage, the general behavior of the fuel during the oxidation process. Again for this simulation, the power starts at 10% and then reaches the 62.6 % of the nominal power. In this simulation we generate steam inside the hot channel and see the behavior of the fuel cladding at temperature where the reaction between the zirconium and the

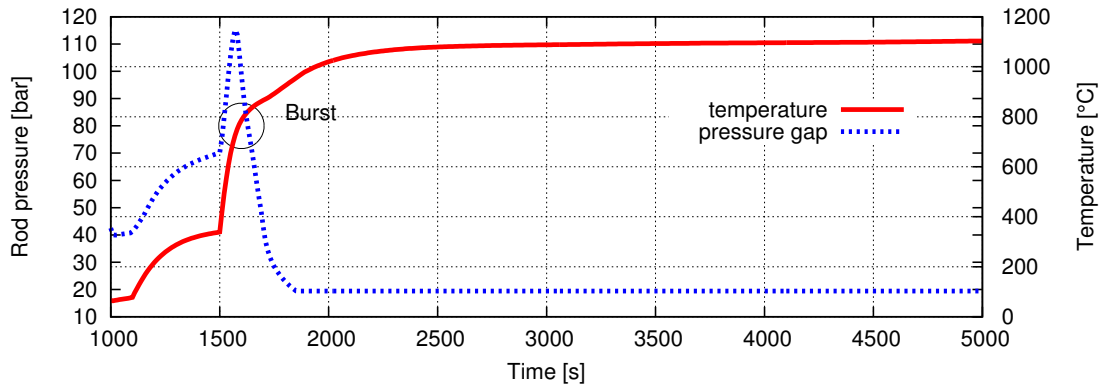

Figure 7: Clad temperature and pressure inside the fuel gap.

water is possible. In order to produce the steam, a small amount of water is kept inside the bottom volume of the device where an electrical heater is located. When the mass of steam is generated, approximately  $7.5g$ , it goes to the hot channel. This steam production generates a peak of pressure inside the channel of about  $18\text{ bar}$  before stabilizing at  $15\text{ bar}$ , as shown in Fig.8.

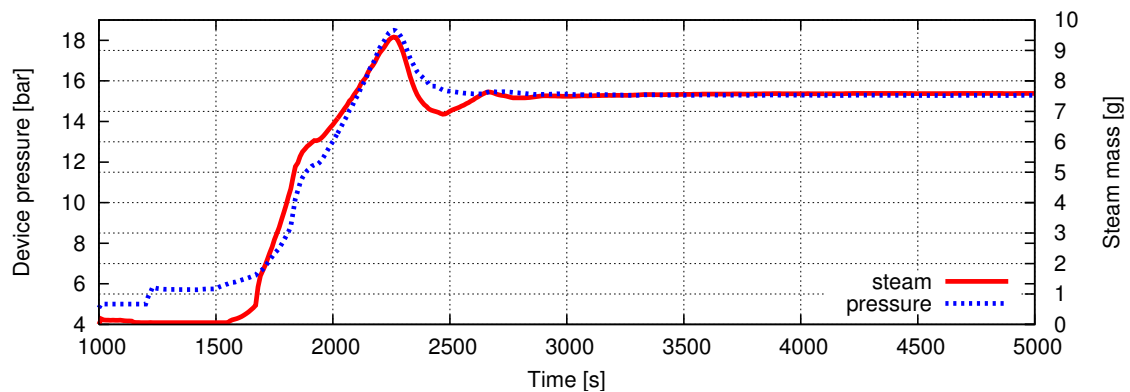

Figure 8: Pressure and steam mass inside the hot channel.

The Fig.9 shows the the oxide thickness and the clad temperature along the center-line of the fuel sample, we can see, for temperature around  $1100\text{ }^{\circ}\text{C}$ , the thickness of the oxide after 66 minutes from the beginning of transient is around  $110\text{ }\mu\text{m}$ .

## 5 CONCLUSIONS

The purpose of this document is to describe the LORELEI test device and present two simulations designed to study real conditions during a loss of coolant accident. In particular in this paper we have focused our investigation on:

1. the limit conditions of the thermosiphon flow;
2. efficiency of a specific module which takes in account the radiation;
3. the proper functioning of the oxidation process in CATHARE-2.

Since we do not have enough experimental data we have compared the CATHARE-2 calculation with a CFD analysis. In spite of the different capability of a three-dimensional CFD and one-dimensional



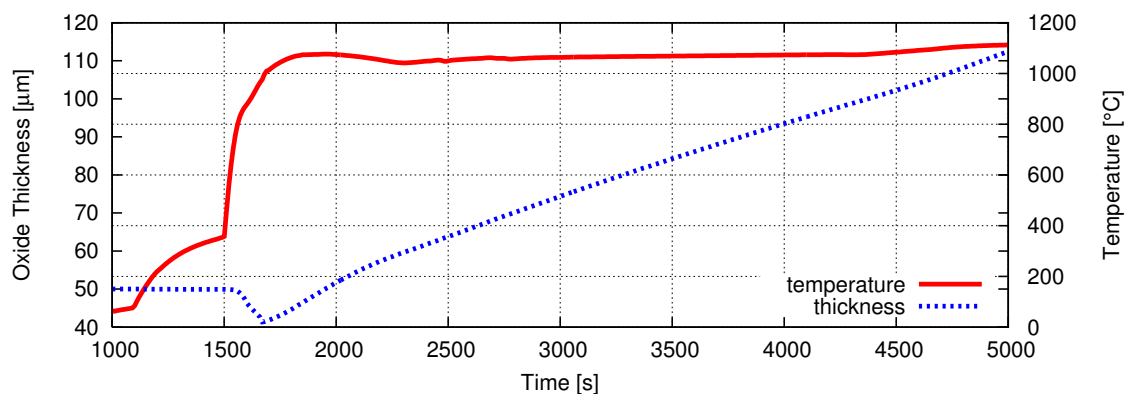

Figure 9: External cladding temperature and thickness oxidation in the center of the fuel

system code we have used these results to evaluate the possibility to study appropriately this physical situation. In particular we have evaluated the specific module used for radiation during the dry phase and we have been able to set realistic limits in the CATHARE-2 code. The goal in the future is to improve the accuracy of the LORELEI modeling and to study more in detail the oxidation process.

## REFERENCES

- [1] L. Ferry, D. Parrat, C. Gonnier, C. Blandin, Y. Weiss, A. Sasson, “The LORELEI Test device for LOCA Experiments in the Jules Horowitz Reactor”, Proc. of WRFPM 2014, Senday, Japan, 2014.
- [2] R. Baviere, F. Perdu, Th. Germain, Boucle Adeline: études thermohydrauliques, DEN/CAD/DER/SSHT, Grenoble, 2010.
- [3] M. Kats, D. Gitelman, H. Shenha, I. Preker, M. Arbel-Haddad, Thermohydraulic design of the LORELEI test device, 2014.