



HAL
open science

An experimental program to characterize confined explosions of hydrogen/oxygen mixtures in the context of radioactive material transport between CEA nuclear facilities

J.-M. Mure, T. Delon, J.-P. Groo

► To cite this version:

J.-M. Mure, T. Delon, J.-P. Groo. An experimental program to characterize confined explosions of hydrogen/oxygen mixtures in the context of radioactive material transport between CEA nuclear facilities. WM2015 Conference - Waste Management 2015 Conference, Mar 2015, Phoenix, United States. cea-02509671

HAL Id: cea-02509671

<https://cea.hal.science/cea-02509671v1>

Submitted on 17 Mar 2020

HAL is a multi-disciplinary open access archive for the deposit and dissemination of scientific research documents, whether they are published or not. The documents may come from teaching and research institutions in France or abroad, or from public or private research centers.

L'archive ouverte pluridisciplinaire **HAL**, est destinée au dépôt et à la diffusion de documents scientifiques de niveau recherche, publiés ou non, émanant des établissements d'enseignement et de recherche français ou étrangers, des laboratoires publics ou privés.

An experimental program to characterize confined explosions of hydrogen/oxygen mixtures in the context of radioactive material transport between CEA nuclear facilities – 15125

Jean-Michel Mure *, Thierry Delon *, Jean-Paul Groo *

*** CEA/DEN/CAD/DSN/STMR – CEA Cadarache Center (France)**

ABSTRACT

CEA, the French Alternative Energies and Atomic Energy Commission, carries out a variety of nuclear research programs in many research reactors and nuclear facilities, decommissioning and dismantling operations that require multiple transports of different type of radioactive material such as radioactive waste or experimental fuel rods using a wide range of transportation packages. Packages are designed, constructed and operated to meet safety and regulatory requirements and must be approved by the French Safety Authority. Application for package approval (e.g. type B package) requires a complete and thorough safety demonstration in which flammable gas generation like radiolysis has become a major issue in the last few years.

To face these challenges, the CEA unit in charge of transport package construction and transport operations (CEA/STMR, Cadarache Center, France), has developed a many-sided approach based on one hand on a better knowledge of both hydrogen gas generation and oxygen consumption in waste materials, and on the other hand, on design of transport packages or waste containers capable of withstanding dynamic pressure loads due to an inner hydrogen/air mixture explosion.

This paper describes the experimental program that CEA/STMR has decided to implement in order to better characterize confined space explosions of hydrogen/oxygen mixtures. It presents how pressure profiles were experimentally measured in various pressure and temperature conditions which are representative of normal and accident transport conditions. It describes how different experimental set-ups were designed and improved progressively so as to obtain reliable and reproducible detonation conditions, investigate the influence of water vapor and characterize pressure profiles (peak pressure, residual pressure, peak duration).

This experimental data will be used to qualify computational models and tools that are used to calculate the structural response of waste containers or fuel canisters, and finally demonstrate the safety of transport packages following an inner hydrogen explosion.

INTRODUCTION

Nuclear facility operations, decommissioning activities and nuclear research programs conducted in CEA experimental reactors, require lots of transports across the French territory and abroad, between or in the vicinity of CEA research centers. In some of these transports, flammable gas generation is a common and recurrent safety issue that has to be tackled to (1) demonstrate that safety functions of transport package are maintained in routine, normal and accident situations and (2) to safely operate radioactive material transports.

Different types of flammable gases may be produced during transportation of radioactive material by various potential mechanisms such as radiolysis and thermolysis. Radiolysis is the decomposition of a material as a result of radiation exposure : alpha, beta and gamma radiation emitted by the radioactive content. Thermolysis is the thermal degradation of organic material, mainly plastic conditioning materials, when temperature increase inside the transport cask becomes significant.

Different type of radioactive material transports have to consider gas generation issues : old decommissioning waste containing unknown amounts of water or conditioned waste produced from nuclear facilities operations ; transport of plutonium oxide powder or plutonium-based ash, on which small amounts of water is adsorbed, have also to be considered at risk.

Hydrogen is the most important flammable gas that is encountered and measured in transport vessel cavities even if radiolysis and thermolysis may produce other gas species such as methane, and in a lesser way, ethane, acetylene, carbon dioxide, carbon oxide and hydrogen chloride.

Safety analysis of hydrogen production compared to flammability limits

When assessing transport package safety, there are two possible scenarios to be studied as regards production of hydrogen in the package cavity during transportation : (1) either it can be conservatively demonstrated that the lower flammability limit (LFL) of the gas mixture is never reached in any void volume inside the waste container or in the package cavity or (2) it cannot be proved that the LFL will not be reached.

The lower flammability limit (LFL) is the minimum concentration above which a mixture of combustible gas in air will become potentially flammable and explosive. LFL value depends strongly on temperature. The below formula is commonly used for hydrogen :

$$LFL(T) = LFL(T_0) \left(1 - \left(\frac{T-T_0}{600-T_0} \right) \right) \text{ (eq. 1)}$$

Where $LFL(T_0) = 4.0\%$ at $T_0 = 25^\circ\text{C}$; temperatures T and T_0 expressed in $^\circ\text{C}$

Applying Eq. 1 at $T = 100^\circ\text{C}$ gives $LFL = 3,48\%$.

If the flammability limit (LFL) is never reached in any of the free volumes of the transport package cavity, or in the case it is reached after a period of time that complies with approval conditions, then safe transport is ensured. In the case it is not possible to demonstrate that the package cavity dot not accumulate unsafe hydrogen concentrations during a radioactive waste transport, it is required to take into account hydrogen/air mixture ignition and subsequent explosion in detonation conditions which is the most conservative conditions regarding peak pressure values. This leads to calculations of pressure profiles that would arise from an inner explosion and to which multiple layers of the containment system would be exposed : nuclear fuel casing or canister, primary waste container or package containment vessel. These data are then used to determine mechanical behavior in order to simply verify safety performance of transport packages in accident conditions of transport (eg : calculate the release of radioactive material) under high pressure loads, or in specific cases, to design pressure resistant vessels or containers.

Some data relative to pressure values reached in the case of hydrogen/air mixtures explosion are available in the literature, but most of the data are from tests performed at ambient temperature and pressure, in unconfined spaces and most always in dry conditions. In the case of safety demonstrations related to the transport of radioactive waste or irradiated nuclear fuel, it is often required to take into account severe temperature and pressure conditions.

On this basis, CEA/STMR decided to conduct an experimental program to measure and characterize pressure profiles that would be representative of transport conditions.

PRESSURE PROFILES EXPERIMENTAL MEASUREMENT

First series of explosion tests

The first step was to design an experimental setup that would represent both a containment vessel cavity among some of the various CEA packages, and a typical nuclear fuel canister or a waste container. A cavity with an inner diameter of 150 mm and a length of 1 meter was chosen (see Figure 1). The cavity volume was 2.5 L.

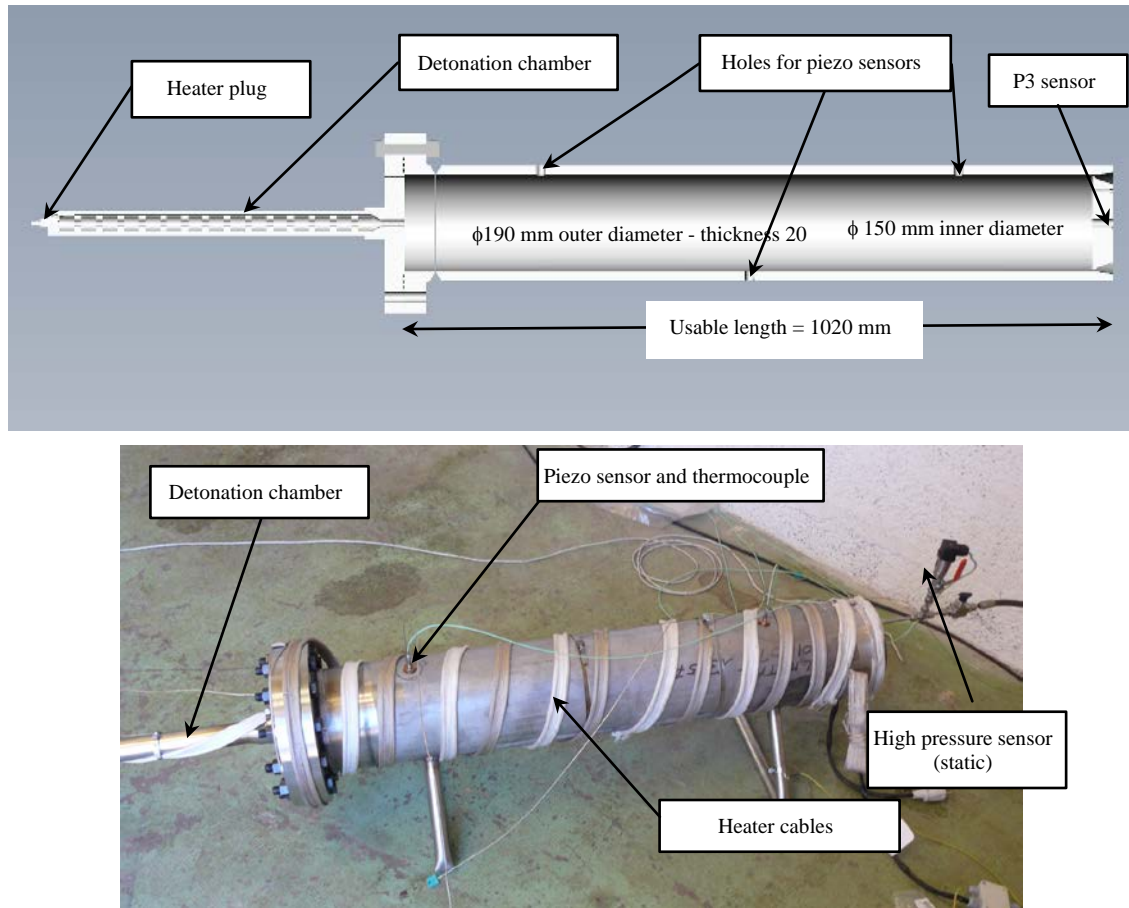

Figure 1 : description of experimental set up

The cavity was fitted with three “piezo” pressure sensors, including a sensor located at the end of the cavity (Figure 1 - P3 sensor). A detonation chamber was also fitted to facilitate detonation conditions as igniting the hydrogen-oxygen mixture directly in the cavity did not always achieve detonation conditions, the shock wave having to travel a certain distance before reaching detonation conditions.

The explosion tests were conducted using a stoichiometric hydrogen and oxygen mixture at different initial pressures (between 1.5 and 2.33 bar) and at different initial temperatures (between 20 and 108°C). Detonation conditions were obtained : the pressure measured by the P3 sensor (i.e. at the base of the cavity facing the shock wave) reached a peak pressure of more than 200 bar for a very short time around 40 to 50 μ s. Although the detonation chamber was designed to get reliable and reproducible explosive

conditions, difficulties were encountered in systematically obtaining the right explosion conditions, i.e. detonation, despite the presence of the detonation chamber.

The first series of tests showed it was possible to obtain detonation conditions but that it was necessary to adapt the experiment setup to obtain more reliable results.

Second series of explosion tests

A second series of explosion tests was carried out aiming at (1) obtaining a better control of explosion conditions (2) investigating effects of temperature and pressure conditions and (3) studying the influence of water vapor. To meet these objectives, the experimental setup was adapted with a new detonation chamber design, subsequently called the flame accelerator tube (FAT), a longer vessel design (length : 2200 mm, diameter : 38 mm) and the use of two photodiodes (Figure 2 : Φ_1 and Φ_2 in blue) on the flame accelerator tube, to measure wave velocity, 5 radial pressure sensors (PC_1 , PC_2 , P_1 , P_2 , P_3) and 1 axial pressure sensor (P_4) and 2 temperature sensors (TC_1 and TC_2).

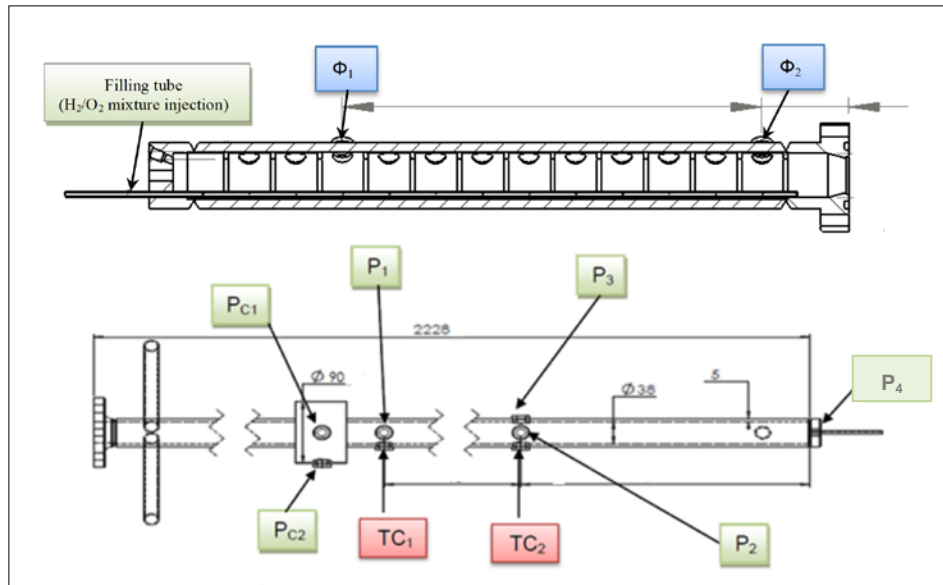

Figure 2 : flame accelerator tube (above) and explosion cavity (below)

Two experimental conditions - dry and humid conditions - were investigated using this new set-up. In dry conditions, temperature and pressure variations were applied and different sensor positions were tested in order to qualify sensor responses. The gas mixture was composed of 66% H_2 and 33% O_2 (stoichiometric mixture). Under humid conditions, the objective was rather to compare radial and axial pressures and investigate the influence of water vapor.

Dry conditions experimental results

Pressure results in

Table I are expressed in bar abs. (absolute pressure). For each sensor, 2 values are given : one for the peak pressure corresponding to the first shock wave peak and the second corresponding to the second peak due to wave reflection on cavity walls (cavity end essentially).

Table I : pressure results for dry conditions experiment

Test number	P _{ini} (bar abs.)	Pressure (bar abs.) measured by sensors P _{C1} , P _{C2} , P ₁ , P ₂ , P ₃ (1 st and 2 nd peak)									
		P _{C1}		P _{C2}		P ₁		P ₂		P ₃	
1a	1					22.5	7.5	15	15		
1b	1			21.5	9.5			15	14.5		
1c	1					23.5	8.5			20.5	21
2a	3			52	33			53.8	63.8		
2b	3			55	36			53.4	62.2		
3a	6					99	75	92.5	112.5		
3b	6					98	75	130	178		
4a	3					63	37			65	76.5
4b	3					65	33.5			53	56.5
5a	3	48.5	35.5					46.5	51.5		
5b	3	49	36					49.5	56		
6a	5					67	59	76.8	85.4		
7a	7					87.5	82	103	139		
7b	7					97.3	98	101	130.9		

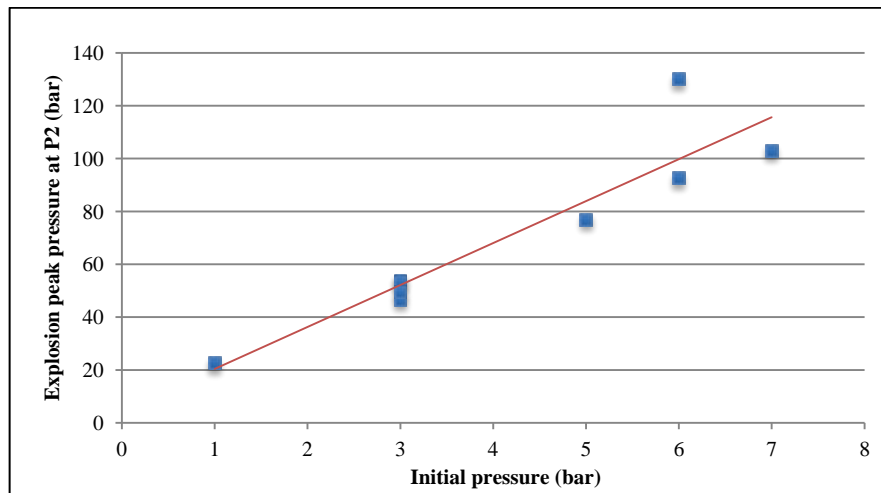

Figure 3 : explosion peak pressure (P2 sensor) vs initial pressure

Table I shows pressure results that were measured by various types of pressure sensors installed along the

explosion vessel. Several sensor positions and types were tested to check consistency and repeatability of the results. Experimental results were also compared to model predictions.

Figure 3 illustrates the relationship between initial pressure in the explosion chamber and the maximal pressure reached shortly after ignition (peak pressure).

Figure 4 shows an example of such a comparison. In this case, experimental and model predictions showed a good fit ; in general it was observed that differences were less than 30%.

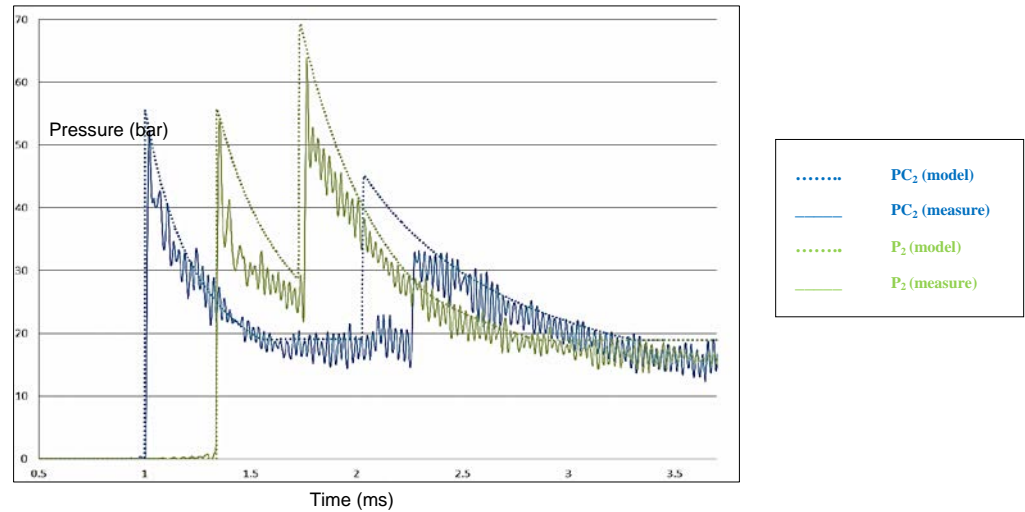

Figure 4 : example of a model-measurement comparison (experiment n°2a)

Description of typical shock wave displacement along explosion cavity

Pressure profiles presented on

Figure 4 can be illustrated into 4 sequences :

1/ The first sensor (PC2) detects the first peak at $T = 1$ ms (Figure 4, blue curve). The pressure measured by PC2 is around 52 bar. The shock wave is already flat on arrival at this point in the explosion cavity.

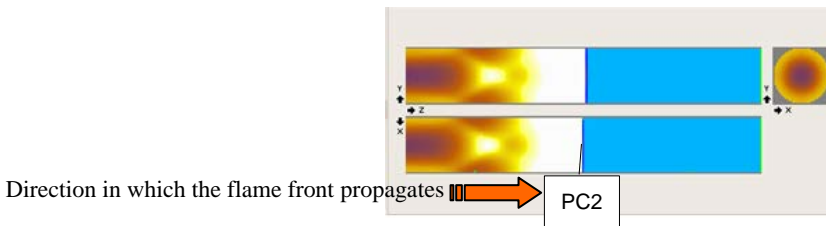

2/ The shock wave continues to travel and reaches sensor P2 a first time at time $T = 1,4$ ms indicating a peak pressure of 53.8 bar.

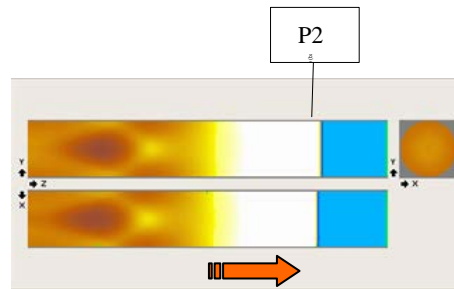

3/ The shock wave is reflected on the back end of the cavity and then bounces back to reach sensor P2 at $T = 1,7$ ms which detects a second peak around 64 bar. The pressure has therefore been amplified by the multiple reflection on the cavity walls.

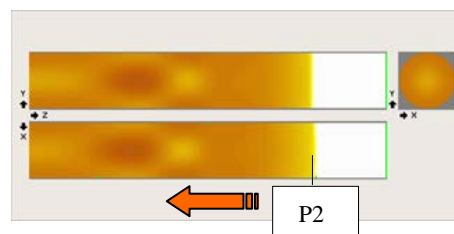

4/ The shock wave finally reaches sensor PC2 a second time at $T = 2,3$ ms indicating a second peak of 33 bar. The shock wave has therefore started to decay.

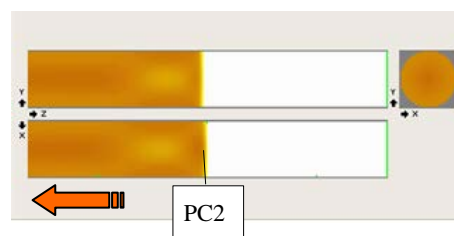

Experimental results under humid conditions

This series consisted of 7 tests (each test was repeated once or twice) in which the same quantity of gas mixture as in dry conditions (0,15 mol of H_2/O_2 mixture) was injected in the cavity in the presence of water vapor. The quantity of water vapor corresponds to the saturated vapor pressure at the initial temperature. Water was injected in the cavity (around 50 ml), the cavity was heated at temperature T_i and the vapor reached its saturated pressure at T_i . The gas mixture was then injected through the filling tube as in the first series. The pressure sensor P_4 (cf. Figure 7) located at the end of the cavity facing the shock wave was used and pressure values recorded.

Table II : pressure results under humid conditions

Test number	INITIAL CONDITIONS					PRESSURE SENSORS					
	P	T	Composition of the gas mixture			Wave velocity (FAT) (m/s)	P _{c2} (bar)	P ₁ (bar)	P ₂ (bar)	Wave velocity (cavity) (m/s)	P ₄ (bar)
	(bar)	(°C)	x _{H2}	x _{O2}	x _{H2O}						
1	1.00	20	65%	33%	2%	2813	14	14.5	16	2532	41
2	1.14	40	62%	31%	6%	-	13	13	15.5	2454	40
3	1.34	60	57%	28%	15%	2206	18	17	16	2222	45.5
4	1.68	80	48%	24%	28%	1480	17	19	20.5	1942	114
5	2.30	100	37%	19%	44%	1957	24	23	12	1262	105
6	3.33	120	27%	13%	60%	1355	15	15	14	1087	70
7	5.02	140	19%	9%	72%	Deflagration conditions					

Results shown in Table I allow to draw the following conclusions :

- the relationship between initial pressure value and peak pressure value was comparable to dry conditions at low water vapor concentrations but as water moisture content increased, it could be shown that the ratio between peak and initial pressures was decreasing : 14/1 at 2%, 18/1,34 at 15% and 17/1,68 at 28%. This tends to demonstrate the negative effect of water vapor on the peak pressure.
- the amplification factor that corresponds to the ratio between the axial peak pressure (measured at the center end of the cavity) and the radial peak pressure (measured on the edge of the cavity) changes in a singular manner. Its mean value, which is around 3 between 20°C and 60°C (Figure 5 – test n°3a), is multiplied by nearly 2 between 80°C and 100°C (Figure 5 – test n°5a). This amplification phenomenon was investigated in the third series of tests to demonstrate that it was very singular and limited to the vicinity of the cavity center.
- the conditions were clearly detonating at initial temperatures less than or equal to 100°C, with the latter case corresponding to a water dilution rate of 44%. As temperature reached 120°C (60% water vapor), the conditions reached the detonation limit and the peak pressure value started to decrease. The conditions became deflagrating for temperatures above 140°C (72% water) as shown on Figure 6.

The experiment allowed to inject water in the explosion chamber and showed that the presence of water that produces gaseous species under radiation exposure which leads to explosive conditions in the vessel cavity may also have an opposite effect and lead to less severe pressure conditions.

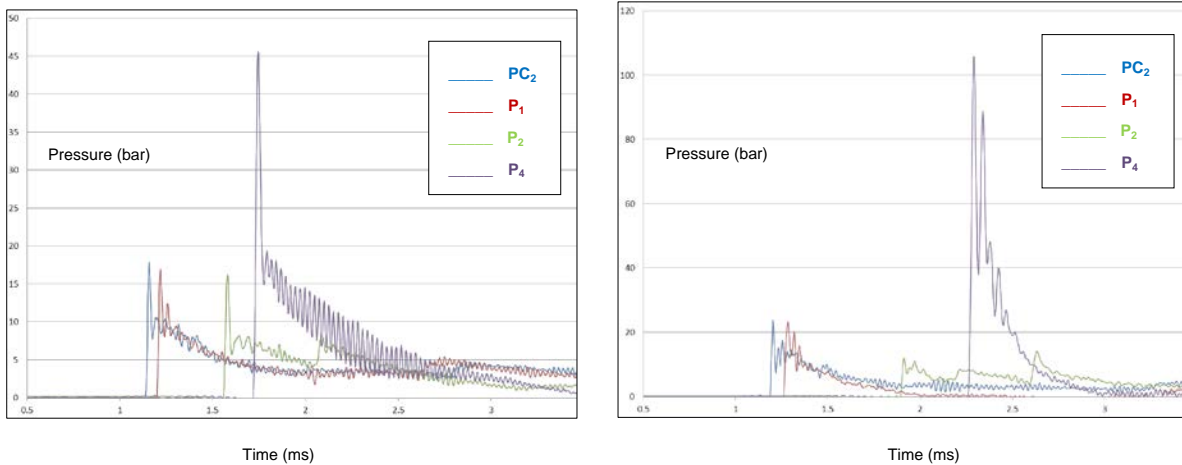

Figure 5 : detonation pressure profiles in 2 different P,T conditions (tests n°3 and n°5)

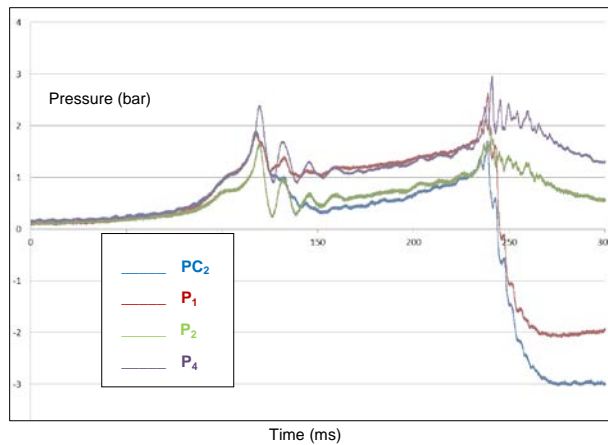

Figure 6 : deflagration pressure profiles (test n°7)

THIRD SERIES OF EXPLOSION TESTS

The first two series of explosion tests were conducted in a device that could be defined as a 1D vessel since it was very long compared to its diameter. A new series of tests was conducted in a so called 2D explosion chamber that is representative of waste drums produced in CEA waste conditioning facilities. The main objectives were to (1) investigate the influence of cavity shape on pressure profiles and (2) to study the influence of sensor location on pressure results. A new vessel was designed with a larger diameter and variable length and several pressure sensors were placed as shown on Figure 7.

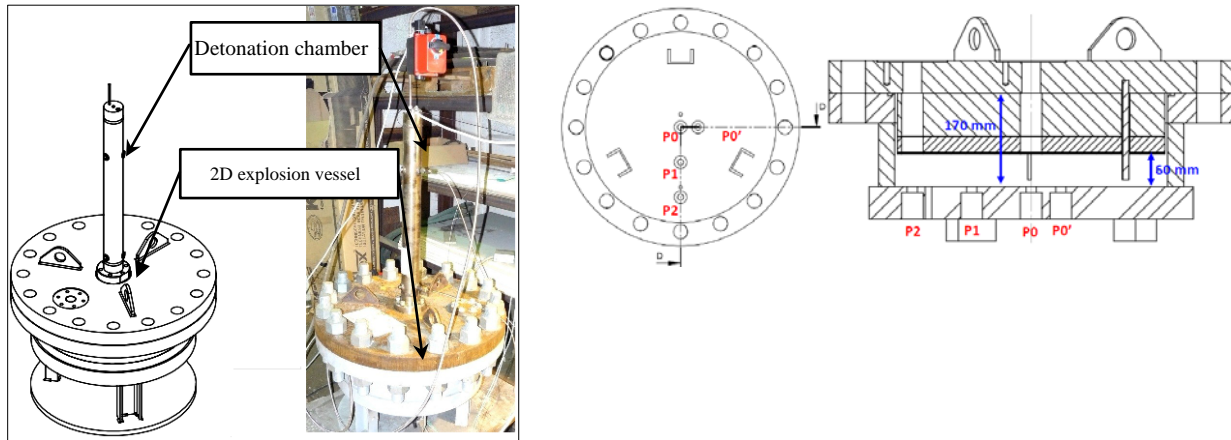

Figure 7 : description of 2D experimental set-up

Three pressure sensors (P_0 in the center, P_1 and P_2 at respectively 110 and 220 mm from the center) were positioned along the same radius on the bottom of the vessel. The $P_{0'}$ sensor was added to measure the pressure near the P_0 central sensor (55 mm from the center). In this third series, explosion tests were performed using a mixture of hydrogen and oxygen introduced in stoichiometric proportions at an initial temperature of $T_i = 20^\circ\text{C}$. Two vessel heights (60 and 170 mm) and therefore two volumes (11.8 and 33.4 liters) were tested at two different pressure levels (1.6 and 2 bar). This resulted in four different cases, i.e. 8 tests with each test doubled up to check the repeatability of measurements.

The results of this third series of tests are presented on 2 different set of graphs in 2 different time periods :

- short time period (detonation peak),
- a time period following the detonation peak of around 50 ms.

Time period < 1 ms

The 8 tests showed a very good repeatability, as illustrated in Figure 8. This demonstrated that the pressures measured over a short period were not random and that the initial conditions were well controlled.

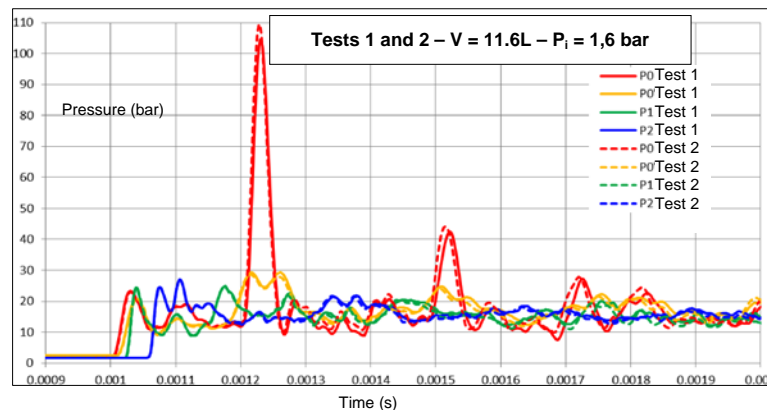

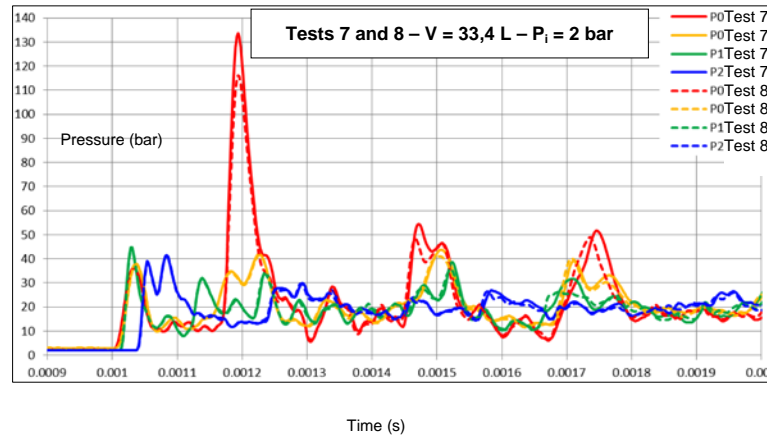

Figure 8 : pressure measured for 2 different initial pressure and volume conditions

The amplification phenomenon observed at the centre of the vessel bottom (P_0 sensor, red curve on Figure 8) characterized by a peak pressure 4 times higher than other points, was very localized since the pressure measured at 55 mm from the centre (P'_0 sensor, orange curve on Figure 8) was around 30 to 40 bar against 110 to 130 bar in the center. This singularity was also confirmed by pressure values measured in P_1 and P_2 . From the results of the 3rd series of tests, it can also be confirmed that :

(1) detonation peak pressure remains proportional to initial pressure. This trend seems to be independent from the cavity volume.

Table III : ratio between initial and peak pressures

		Initial pressure (bar)		Ratio
		1.6 bar	2.0 bar	
Cavity volume	11.8 L	25	31	1.24
	33.4 L	36	45	1.25

(2) cavity volume has a significant impact on the pressure at any given initial pressure. This difference (factor of 1.5) cannot be directly explained by the difference in volume but rather by the cavity shape. In the case of the 11.8 liter cavity, the height was 60 mm and the radius 250 mm. The flame front therefore moved quickly in a radial direction. There was little or no amplification since there was no wave reflection on the bottom. In the case of the 33.4 liter cavity, the height was 170 mm and the reflection phenomenon on the bottom of the vessel was thus greater, with a peak pressure of 45 bar, i.e. an amplification factor of $45/25 = 1.8$. Figure 9 shows the pressure curve recorded by the P_1 sensor in the cases of an 11.8 liter cavity and a 33.4 liter cavity (at initial pressure = 2 bar) and clearly demonstrates the amplification due to geometry of the explosion chamber.

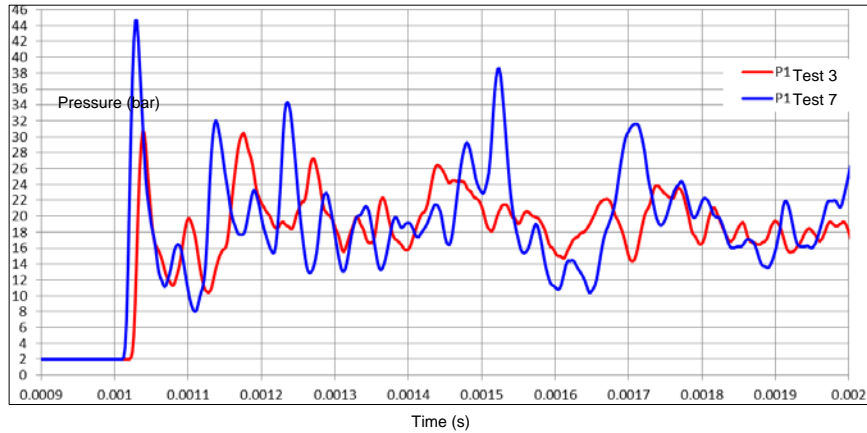

Figure 9 : recorded pressure for 2 different cavity volumes (P = 2 bar)

Time period after explosion (t > 50 ms)

This section discusses the pressure variation in the cavity during the time period beyond the explosion peak. Figure 10 shows the pressure variation recorded by P1 sensor in the case of an 11.8 liter cavity and a 33.4 liter cavity (for an initial pressure of 2 bar).

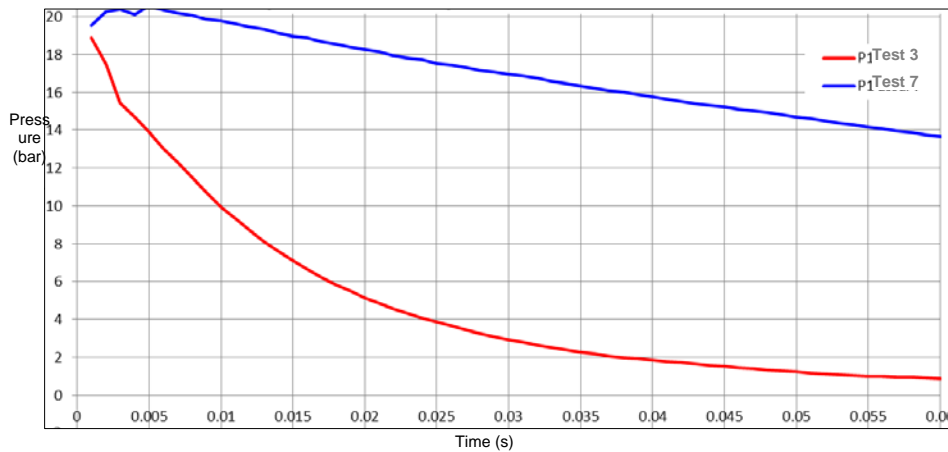

Figure 10 : pressure at P1 for 2 different cavity volumes (V=11,8 L red curve and V=33,4 L blue curve)

Table IV : pressure decrease over a 50 ms period (P₂ sensor)

Initial conditions (cavity volume and initial pressure)	Residual pressure (bar)				
	2 ms	5 ms	10 ms	20 ms	50 ms
11.8 L, 1.6 bar	14.0	11.0	8.3	4.7	1.6
11.8 L, 2 bar	18.2	14.9	11.5	6.1	1.1
33.4 L, 1.6 bar	15.8	15.2	14.3	12.4	8.0

Initial conditions (cavity volume and initial pressure)	Residual pressure (bar)				
	2 ms	5 ms	10 ms	20 ms	50 ms
33.4 L, 2 bar	20.0	20.1	19.5	18.0	13.6

A possible interpretation of the differential variation in the mean cavity pressure could be related to the cooling of burnt gases that occurred more rapidly in the 'narrow' 11.8-liter cavity and lead to a pressure decrease around a steady value of 1.2 bar at 50 ms, compared with the 33.4-liter cavity which lead to a value of 15 bar at 50 ms. The same trend was measured at P2 sensor as shown on Table IV : pressure decrease to near 1 bar in the 11,8 l cavity compared to a pressure ten times higher in the 33,4 L cavity.

CONCLUSION

Generation of hydrogen produced by water radiolysis during transport between nuclear facilities is a major concern in transport safety since hydrogen explosion can lead to the loss of radioactive material into the environment. Most of the time, safety demonstration and conservative model predictions associated to limited transport duration succeed in verifying that hydrogen levels inside packages always remain below LFL concentrations (< 4 %). In some specific cases, eg. when primary waste containers can not be opened before transport when old waste cannot be fully characterized or in the case of nuclear irradiated fuel transport, when vessel cavity can not be fully dewatered after vacuum draining, the demonstration that safety of transport packages is maintained may require a thorough calculation of the cavity structural response after inner hydrogen explosion. Too much conservative assumptions and bounding calculations make it sometimes difficult to conclude to safe conditions.

An experimental research program has been set up to build and design representative explosion cavities, equipped with qualified pressure sensors, record pressure profiles in different pressure and temperature conditions, in a repeatable manner. Presence of water vapor in cavity atmosphere and cavity shape influence were also investigated.

The main conclusions that could be drawn from these experiments were :

- initial pressure value in the package cavity is a key parameter that has a great influence on the peak pressure resulting from an inner cavity hydrogen explosion ;
- presence of water has a negative effect since peak pressures values are lower under humid conditions than in dry conditions, leading so some extent to deflagrating conditions when water vapor concentrations are too high ;
- cavity geometry and cavity volume have a major influence both on peak pressures and on pressure values measured in the time period after hydrogen explosion.

Experimental investigations will be carried on to qualify models used in safety calculations, to make less conservative safety calculations, to design, if necessary, primary waste containers or fuel canisters, or in very specific cases, design transport packages that can withstand high pressure loads arising from inner cavity hydrogen explosion.