



**HAL**  
open science

## Jules horowitz reactor update of the experimental capacity

C. Blandin, J. Estrade, J. Pierre, P. Jaekki, C. Colin, T. Dousson, L. Ferry, C. Gonnier

### ► To cite this version:

C. Blandin, J. Estrade, J. Pierre, P. Jaekki, C. Colin, et al.. Jules horowitz reactor update of the experimental capacity. Research Reactor Fuel Management (RRFM) 2015, Apr 2015, Bucarest, Romania. cea-02509280

**HAL Id: cea-02509280**

**<https://cea.hal.science/cea-02509280>**

Submitted on 16 Mar 2020

**HAL** is a multi-disciplinary open access archive for the deposit and dissemination of scientific research documents, whether they are published or not. The documents may come from teaching and research institutions in France or abroad, or from public or private research centers.

L'archive ouverte pluridisciplinaire **HAL**, est destinée au dépôt et à la diffusion de documents scientifiques de niveau recherche, publiés ou non, émanant des établissements d'enseignement et de recherche français ou étrangers, des laboratoires publics ou privés.

# JULES HOROWITZ REACTOR: UPDATE OF THE EXPERIMENTAL CAPACITY

C. BLANDIN, J. ESTRADE, J. PIERRE, P. JAECKI, C. COLIN, T. DOUSSON,  
L. FERRY, C. GONNIER,  
*French Alternative Energies and Atomic Energy Commission (CEA<sup>2</sup>)  
CEA, DEN, DER, SRJH, F-13108 Saint-Paul-lez-Durance, France*

## ABSTRACT

The Jules Horowitz Reactor (JHR) is a high performance Material Testing Reactor under construction in southern France (CEA/Cadarache research centre), that will carry out experimental irradiations for Nuclear Power Plants (NPP) and fuel vendors, utilities, safety organizations and research institutes. Therefore CEA is developing a set of test devices that will be operational for the start-up of the reactor or few years later. These experimental hosting systems will have to fulfil experimental needs concerning current NPP technologies (GEN II-III) and future reactors (GEN IV) as well.

Experimental programs could be related to either fuel basis properties acquisition, mastering of margins or improvement of fuel products (clad and pellet), in term of performance, safety, maximum burn up, innovative materials or extension of validation domain of fuel performance codes.

Then the present paper describes the main experimental hosting systems currently under design:

- The MADISON device will be available at the JHR start up, and will allow testing the comparative behaviour of several instrumented fuel rods (from 1 up to 8 rods, of up to 60 cm fissile stack height) under NPP normal operating conditions (no clad failure expected).
- The ADELIN device will be available for the JHR start up, and will allow testing a single experimental rod up to its operating limits. The fuel rod will be tested under conditions that correspond to off-normal situations with possible occurrence of a clad failure. The first version so called ADELIN “power ramps” will focus on the clad failure occurrence during one of these abnormal situations.
- The LORELEI device will be available few years after the reactor start up and will allow testing a single rod under accidental situation that may lead to fuel damage. It will be able to reproduce all sequences of a LOCA-type transient, including the re-irradiation, the loss of coolant and the quenching phases, on a separate effect approach.

In-core and in reflector material test devices are presented as well, corresponding to large ranges of irradiation conditions, in terms of temperature, neutron flux and neutron spectra. A special attention focuses on the improvement of the thermal stability and gradients in the interest zones of irradiated samples. Some specific devices are described such as equipments designed to the qualification of reactor pressure vessel steels (OCCITANE test device), to the studies of creep-swelling of structural materials (MICA test device) or to the study of the stress corrosion cracking assisted by irradiation phenomena (CLOE test device: a corrosion loop with an accurate water chemistry monitoring for PWR or BWR requirement).

## 1. Introduction

The Jules Horowitz (JHR) Material Testing Reactor will be commissioned by the end of this decade as an international user’s facility on the CEA/Cadarache site. It will be dedicated to materials and fuel irradiations for the nuclear industry, utilities, TSO,

regulators, or research institutes. As an associated objective, the JHR will also contribute to secure the production of radioisotopes for medical applications. A detailed presentation of the project status is given in ref. [1].

The design of this facility allows a large flexibility in order to comply with a broad range of experimental requirements, regarding the type of samples (fuel or material), neutron flux and spectrum, type of coolants and thermohydraulics conditions (LWR, Gen IV,...), in accordance with the scientific objectives of the programs. These experimental tools are under development and some of them will be available at JHR start up.

After reminding the main characteristics of the reactor facility, the experimental capacity is described and a focus on the main test devices under development is given.

## 2. Main Characteristics of the JHR facility and experimental capacity

This facility is based on a 100 MW pool reactor compact core cooled by a slightly pressurized primary circuit. The core tank is located in the reactor pool.

### 2.1 A modern facility with a large area dedicated to experiments

The nuclear facility comprises a reactor building with all equipments dedicated to the reactor and experimental devices and an auxiliary building dedicated to tasks in support for reactor and experimental devices operation (see Figure 1).

The reactor building is designed to provide the largest experimental capacity possible with the largest flexibility. One half of this building is dedicated to the implementation of equipments in support to in-pile irradiations (for example, water loops). This corresponds to 700 m<sup>2</sup> over 3 floors for implementation of experimental cubicles and 490 m<sup>2</sup> over 3 floors for instrumentation and control equipments.

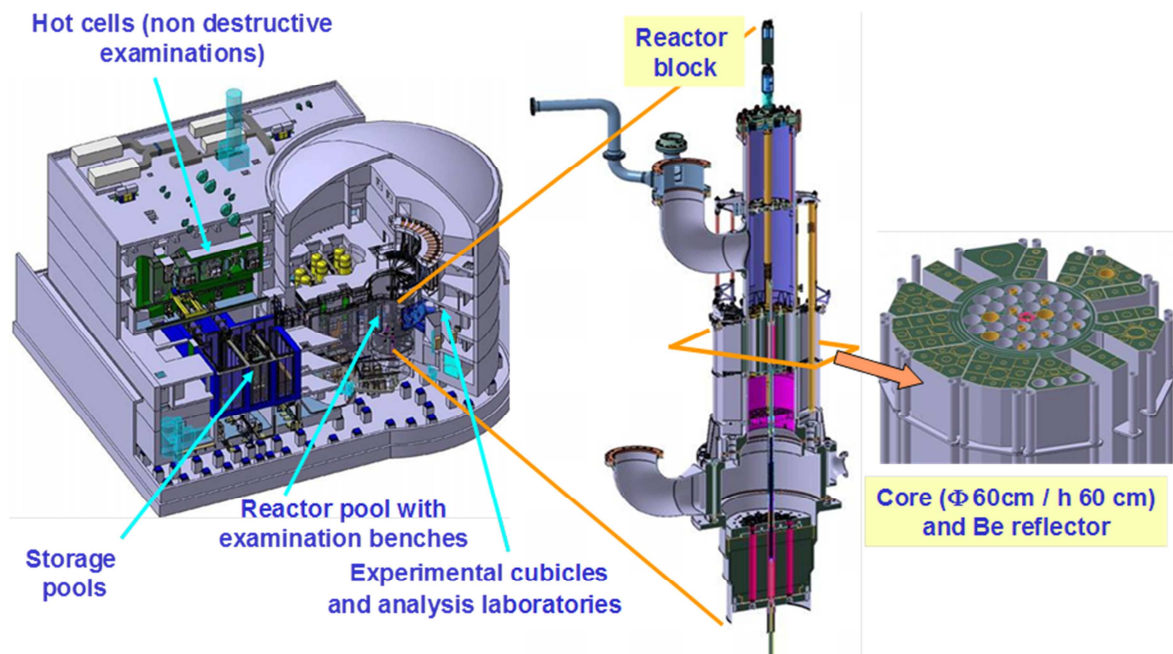

Figure 1: Views of the JHR facility and the reactor core

### 2.2 A powerful reactor with numerous irradiation sites and irradiation conditions

The design of the reactor (see Figure 2) provides irradiation sites situated inside the reactor core with the highest ageing rate (up to 16 dpa/year) and irradiation sites situated in the Beryllium reflector zone surrounding the reactor, with the highest thermal flux.

Numerous locations are implemented (up to 20 simultaneous experiments) with a large range of irradiation conditions:

- 7 in-core locations of small diameter (32 mm) with a high fast neutron flux (up to  $5.5E14 \text{ n.cm}^{-2}.\text{s}^{-1}$  perturbed flux above 1 MeV)
- 3 in-core locations of large diameter (80 mm) with a high fast neutron flux (up to  $4.E14 \text{ n.cm}^{-2}.\text{s}^{-1}$  perturbed flux above 1 MeV)
- 20 fixed positions (100 mm of diameter and one location with 200 mm) with a high thermal neutron flux (up to  $3.5E14 \text{ n.cm}^{-2}.\text{s}^{-1}$  perturbed flux)
- 6 positions located on displacement devices located in water channels through the Beryllium reflector

A typical reactor cycle is expected to last 25 days, and CEA targets to operate the reactor 10 cycles per year.

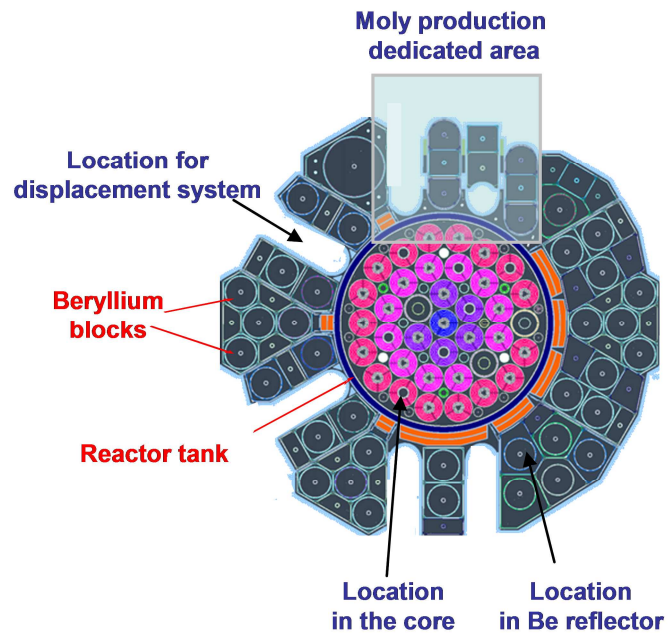

Figure 2: Views of the experimental locations

### 2.3 Non-destructive examination benches

The JHR experimental programs will also take advantage from Non-Destructive Examination (NDE) benches, present in the facility with the aim of significantly improving the scientific quality of the JHR irradiation process:

- A coupled gamma scanning-X tomography bench located in the reactor pool (adapted to welcome irradiation devices) (see details in ref. [3]) ;
- A neutron radiography bench (developed with EDF support) located in the reactor pool (see details in ref. [2]) ;
- A coupled gamma-X tomography bench, identical to the previous one and located in the storage pool of the Nuclear Auxiliary Building ;
- Non-destructive examinations in hot cells after extraction from the experimental devices (visual inspection, photography, metrology and Eddy Current testing).

These NDE stands can be used at several steps of the experimental program:

- For initial check of experimental load status by the irradiation phase (after transportation, assembly in JHR hot cell or insertion in the device) ;
- For adjustment of experimental protocol or control parameters after a first short irradiation run ;
- For a rapid examination of samples after an irradiation phase (e.g. geometrical changes after an off-normal transient, quantification of short half-life fission product distribution...) when the examination is performed in the reactor pool with limited handling ;
- For a delayed detailed examination of samples after the end of an irradiation program when the examination is performed in the storage pool, either for scientific data acquisition or for defining samples status before transportation.

### 3. Irradiation hosting systems available at the JHR start-up

#### 3.1 MADISON test device

This test device will carry out irradiations of LWR fuel samples (60 cm fissile stack) when no clad failure is expected. Consequently, the experimental conditions correspond to normal operation of power reactors (steady states or slow transients that can take place in nuclear power plants) (ref. [4]).

This experimental device is made of an in-pile part (holding the fuel samples) fixed on a displacement system. This system allows on-line regulation of fuel linear power on the samples. Thanks to the high thermal neutron flux in the JHR reflector, this is possible to reach high linear power even on high burn-up samples (as an example, it is possible to reach 400 W/cm for a burn up of 80 GWd/t for a common UO<sub>2</sub> fuel of initial enrichment 4.95%).

The in-pile part is connected to a water loop providing thermal-hydraulics conditions expected for a given experimental program. The water loop (implemented in a dedicated cubicle, see Figure 3) allows reproducing the thermal-hydraulics conditions of nuclear power plants (PWR, BWR or WWER technologies) in terms of water loop pressure (up to 160 bar) and temperature (up to 320°C). A specific chemical analysis system and a water treatment system allow a continuous regulation of chemical conditions.

In order to meet the large range of experimental needs expressed by the nuclear industry, the test section of the in-pile part has a large volume. This allows loading a large panel of sample holders from high embarking capacity (up to 8 samples) with low instrumentation to low embarking capacity (up to 1 sample), but highly instrumented.

The first irradiation rig version has a carrying capacity of 4 fresh or pre-irradiated samples (with a maximum of 2 sensors per sample) and is flexible enough to operate with 2 samples (highly instrumented).

For sample instrumentation, 5 tight high temperature and pressure connectors are implemented on the sample holder to allow the plug-in of specific instruments (see Figure 3).

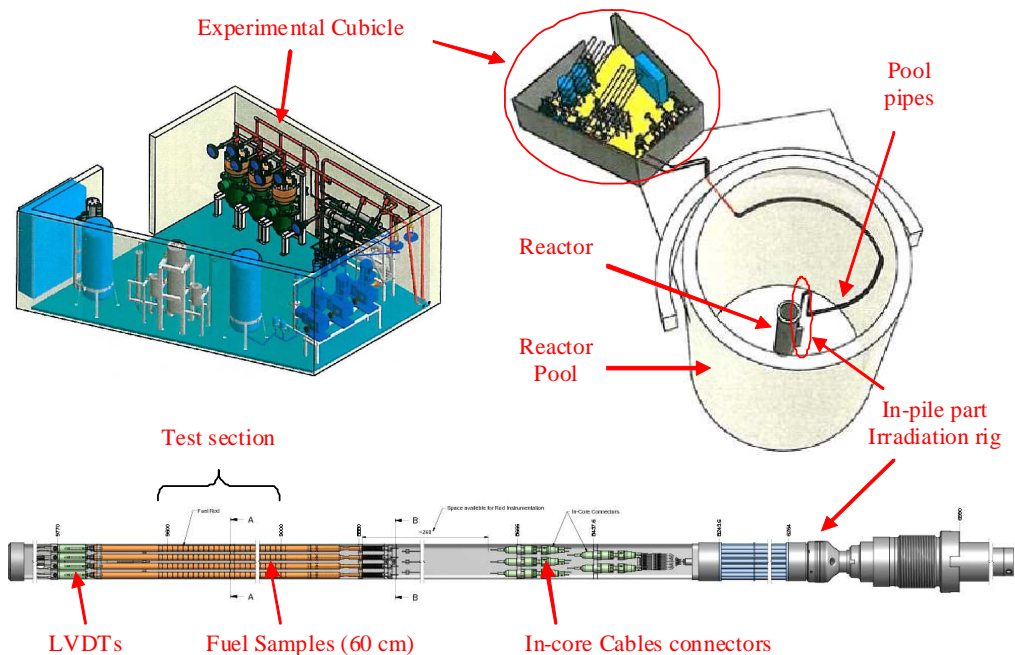

Figure 3: Views of the MADISON test device with focus on the water loop and on the first rig

The following instrumentation can be easily used in the first MADISON sample holder manufactured for the JHR start up: fuel central temperature, clad temperature, clad elongation, fuel stack elongation, fuel plenum pressure, fission gas release composition based on acoustic measurement device.

### 3.2 ADELIN test device

The ADELIN test device, developed with EDF support, is able to hold a single experimental fuel rod from all LWR technologies to reproduce various experimental irradiation scenarios where clad failure is either a risk or an experimental objective (ref. [4]). Similarly to the MADISON experimental device, this experiment is made of an in-pile part and an out-of-pile water loop (see Figure 4). Fresh or pre-irradiated fuel rods can be used to perform: power ramp tests, rod internal over-pressurization (“lift-off”), rod internal free volumes gas sweeping or power to melt approach margin mastering.

A first version is mainly dedicated to power ramps testing. In particular, the design of this device is optimized to provide a qualified thermal balance and a good accuracy on the clad failure instant and consequently a good knowledge of the linear power inducing the failure. A quantitative gamma spectrometry system allows quantifying the radiological source term released in the coolant since a rod fails.

Some enhancements are added in order to make on-line quantitative clad elongation measurement during power transients and to manage several successive experiments during one reactor cycle. In addition, this device can be easily upgraded in order to manage highly instrumented experiments with fuel and clad temperature measurement and fission gas release measurement by gas sweeping. In a longer term, a second version will be dedicated to the study of the long-term post-failure behaviour in normal conditions (failure evolution, secondary hydriding, release of fission products and of fissile material...), coupled with the fission product laboratory.

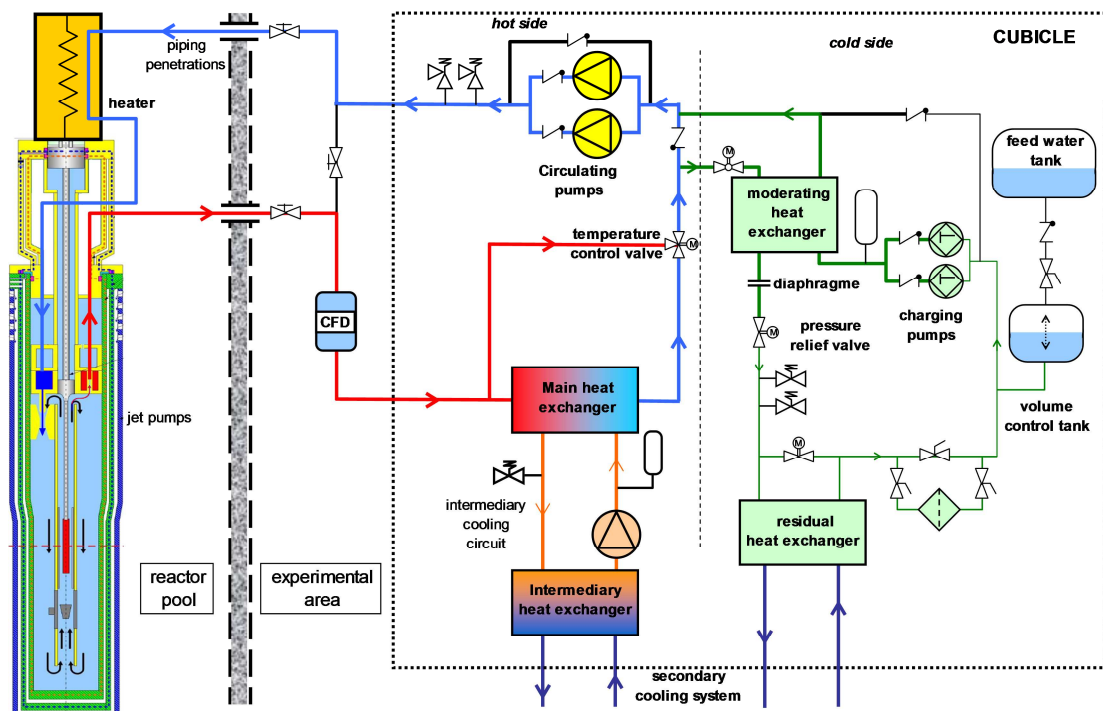

Figure 4: Schematic diagram of the ADELIN loop

A typical PWR power ramp sequence is made of the following phases (see Figure 5):

- A low power plateau (from 0.5 up to 7 days) with control of clad surface temperature at 330°C ( $\pm 10$  °C) while the sample linear heat rate is controlled between 50 and 250 W/cm, depending on customer's request ;
- A linear power ramp at a continuous rate ranging between 100 and 700 W.cm<sup>-1</sup>.min<sup>-1</sup>. During this phase, clad surface temperature is stable at saturation condition, as soon as the sample reaches 350 W.cm<sup>-1</sup> at its peak level ;
- A high power plateau that may last 24h at a linear heat rate up to 620 W.cm<sup>-1</sup> (at the sample peak level).

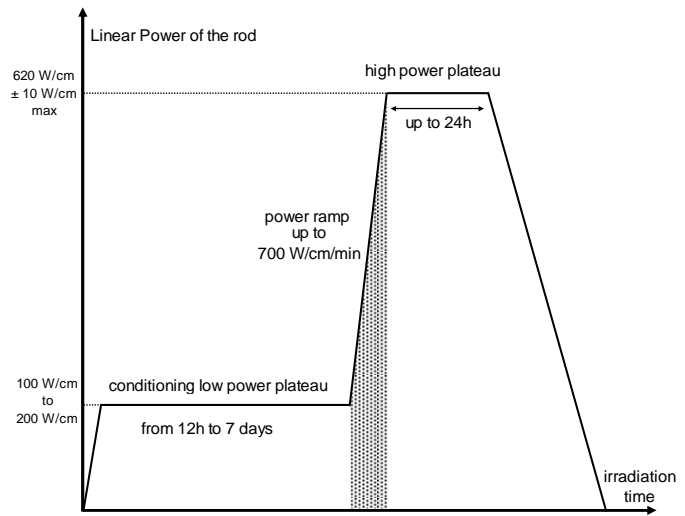

Figure 5: Standard power ramp test time history

### 3.3 MICA test device

The MICA test device is devoted to the irradiation of materials, such as fuel cladding materials or NPP internal structures materials. It consists of 2 concentric tubes delimiting a gas gap (see Figure 6), which is mainly used to adjust the temperature inside the internal tube (gap dimension, nature of the gas).

Electric heating elements are placed on the internal tube, embedded within an aluminium spray. This heating method ensures fine control of the samples temperature.

The MICA device has the same performances than the current CHOUCA test device widely used in OSIRIS reactor, i.e. irradiation of various geometries of samples in NaK (up to 450°C) or gas (up to 1000°C). These test devices are mainly designed for in core irradiations where fast flux can reach up to 16 dpa a year (at 100 MW).

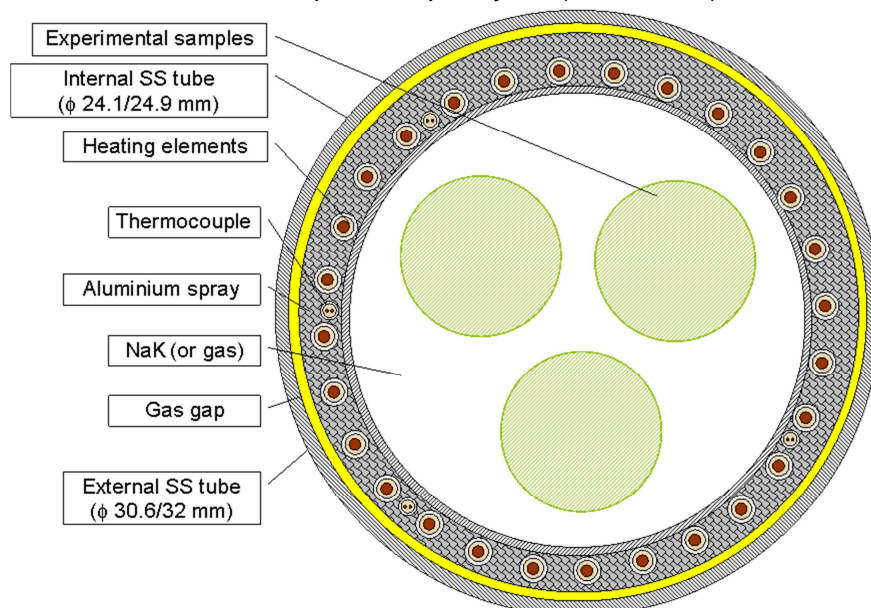

Figure 6: MICA test device cross-section.

## 4. Irradiation hosting systems available after the JHR start-up

### 4.1 CALIPSO test device

As the MICA hosting system, the CALIPSO test device (in-Core Advanced Loop for Irradiation in Potassium Sodium) is mainly dedicated to the irradiation of material samples immersed in NaK. Unlike MICA, NaK is not static within CALIPSO: a NaK flow is indeed induced with an innovative electromagnetic pump, implemented in upper in-pile part of CALIPSO (see Figure 7). This embedded thermohydraulic loop features mainly an electrical heater and a heat exchanger as well. CALIPSO meets the original need of a low temperature axial gradient (a maximum of 8 °C is the target) all along the samples stack, up to 450°C for a first step of development, and up to 600°C in a second phase. The setting of each parameter (power of heater, flow of the pump and efficiency of exchanger) will lead to a full control of the thermal conditions inside the test device and in particular in the sample location. Qualification tests with a regular scale CALIPSO model (and thus the innovative electromagnetic pump) have been successfully performed in 2014 using a dedicated experimental platform so called SOPRANO.

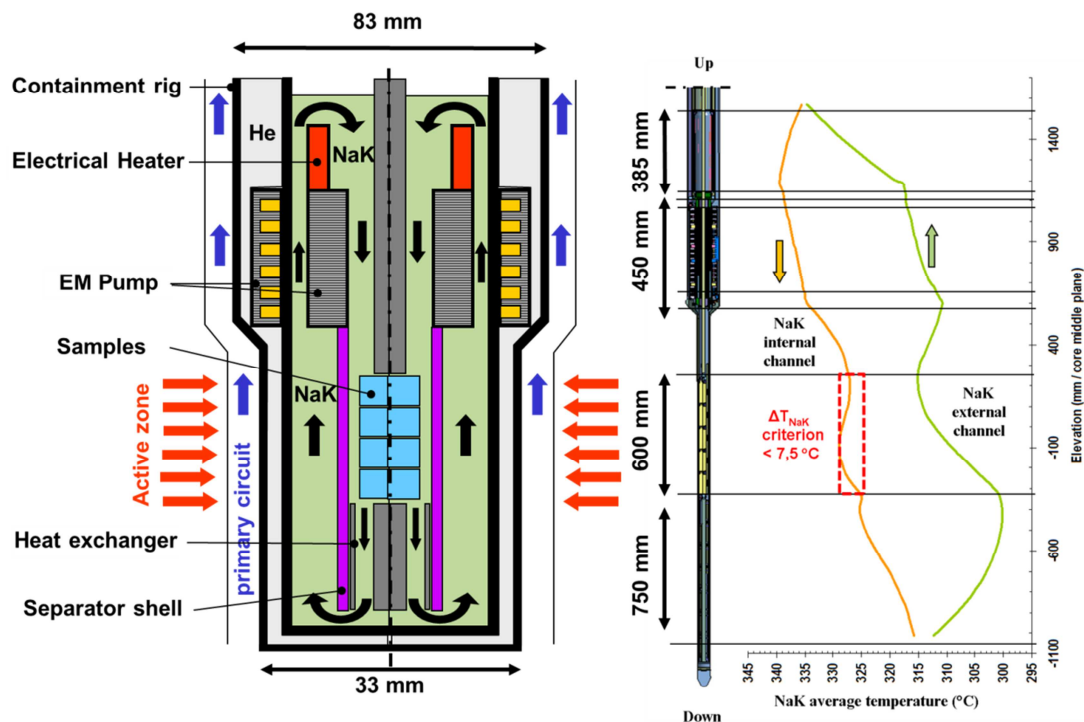

Figure 7: CALIPSO functional sketch

### 4.2 OCCITANE test device

In the field of pressure vessel steels of NPPs, irradiations are carried out to justify the safety of this 2nd containment barrier and to improve its lifetime. Then CEA is designing a hosting system so named OCCITANE (Out-of-Core Capsule for Irradiation Testing of Ageing by Neutrons), which will allow irradiations in an inert gas at least from 230 to 300°C. It will be implemented in the JHR reflector and reach damage rate around 100 mdpa/year ( $E > 1$  MeV). The associated instrumentation will include at least thermocouples and activation foils as close as possible to the samples. OCCITANE is based on IRMA device of OSIRIS. The ongoing design studies consist mainly in decreasing thermal gradient in the sample area (see Figure 8) and in integrating the capsule to the JHR environment.



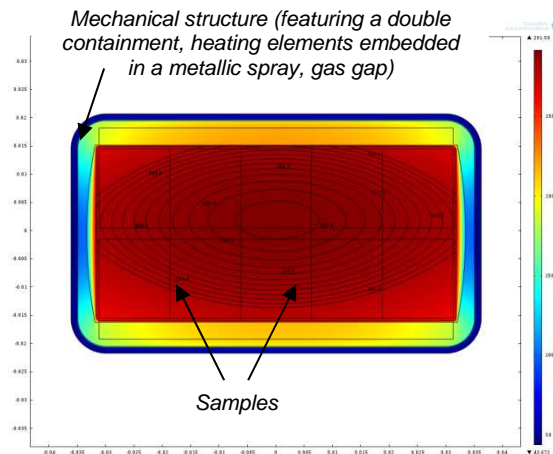

Figure 8: Calculated temperature map in the OCCITANE device (core mid-plane, 0.6 W/g)

### 4.3 CLOE test device

Due to ageing of the NPPs, stainless steel core components undergo increasing radiation doses, which enhance their susceptibility to local corrosion phenomena, known as irradiation-assisted stress corrosion cracking (IASCC). Cold laboratories can study and model SCC phenomena; but to really be representative of LWR environments, these studies require integral tests in MTR to take into account irradiation effects (radiation dose and flux). To answer to these industrial needs, DAE (India) and CEA have launched the design of a LWR corrosion loop (so-called CLOE), likely located in the JHR reflector, close to the tank. Then CLOE will reproduce as close as possible the nominal environment of LWR reactors, including well known and well controlled water chemistry and will allow to apply a mechanical loading of the specimens during the experiment (see Figure 9).

This test device will be made of a double wall pressure flask (cylindrical shape) containing an irradiation rig which will carry the samples and all measurement sensors for experimental and safety purpose. This in-pile part will be connected through under-water pipes to experimental components such as pumps, heat exchangers or water tanks located in an experimental cubicle (see Figure 10).

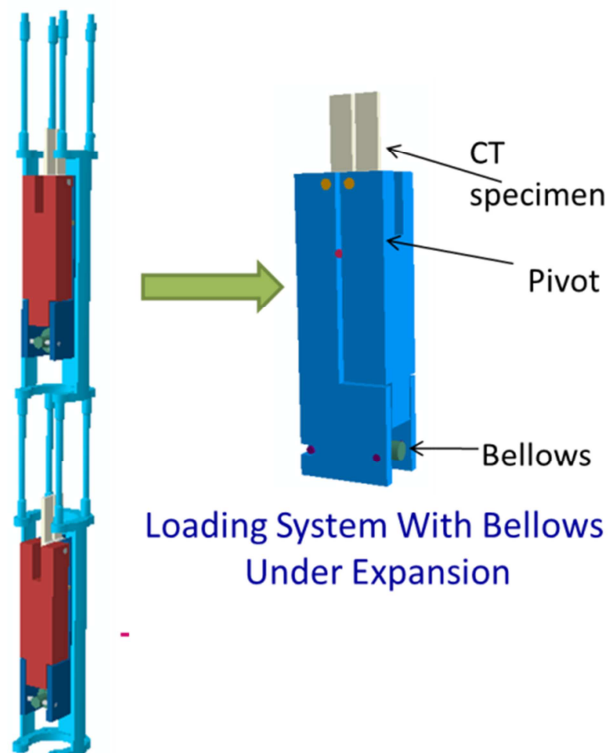

Figure 9: View of CLOE sample holder

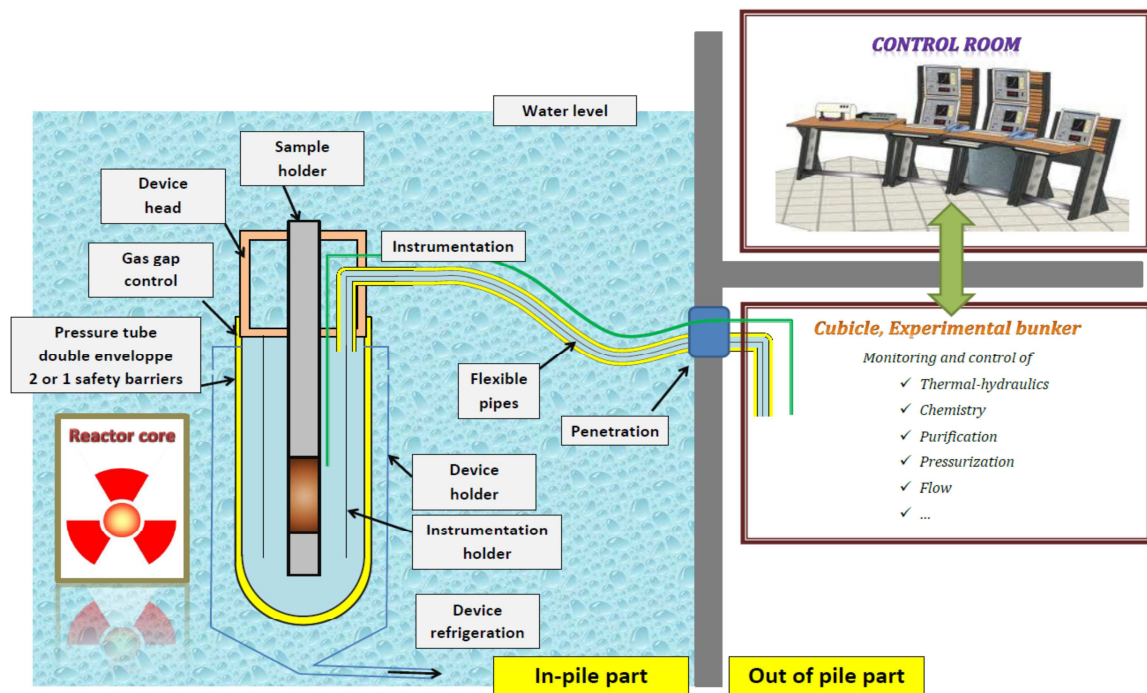

Figure 10: Architecture of the JHR Corrosion Loop (CLOE)

#### 4.4 LORELEI test device

The purpose of LORELEI device is to investigate the behaviour (thermal-mechanical and radiological consequences) of LWR-type pre-irradiated fuel rods under “Loss Of Coolant Accident” conditions (ref. [4]). The thermal-hydraulic phenomena does not reproduce all phases of a realistic LOCA-type power reactor sequence (in particular the first clad temperature peak), but the thermal-mechanical conditions (clad temperature, clad over-pressure, steam environment) will be representative (see Figure 11).

This equipment consists in an integrated water capsule that can be operated as a thermosiphon able to cool and re-irradiate a single pre-irradiated fuel sample, and to produce a short half-life Fission Product (FP) inventory. For the first version of the test device, the re-irradiation power is low and adapted to the production of a detectable short half-life FP inventory (versus long half-life radionuclides already present in the fuel material). Next version will allow reproducing thermal conditions representative of current LWR power reactors and performing a re-irradiation of samples at higher power in order to simulate the effects of the local peak power (“core hot spot”) and to produce a representative FP inventory and distribution at the accidental sequence start-up.

It is equipped with a gas injection able to rapidly empty the test device in order to simulate the dry-out phase of the fuel rod during LOCA transient. A neutron shielding can be used to flatten the axial neutron flux profile. An electrical heater implemented in the sample holder allows getting a homogeneous temperature azimuthal distribution and acts as a dynamic thermal insulation in order to get representative adiabatic conditions (initial heat-up rate depending on customer request and typically ranging from 10 up to 20°C/s).

The high temperature phase (up to about 1200°C) will be monitored by adjusting the rod nuclear power with the displacement system. During this phase, the electrical heater will be switched-off in order to increase heat losses and to prevent any temperature escalation (e.g. due to steam – zirconium reaction). At last, low temperature water can be re-injected in the device to simulate the quenching process.

This device, designed in collaboration with IAEC (Israel), allows investigating ballooning and burst of the fuel cladding (the inner pressure of the fuel rod can be monitored to that purpose), clad corrosion phenomena (oxidation and hydriding), thermal-mechanical behaviour, quenching, post-quench behaviour and fission product release. To that purpose, the device will be connected to a fission product laboratory.

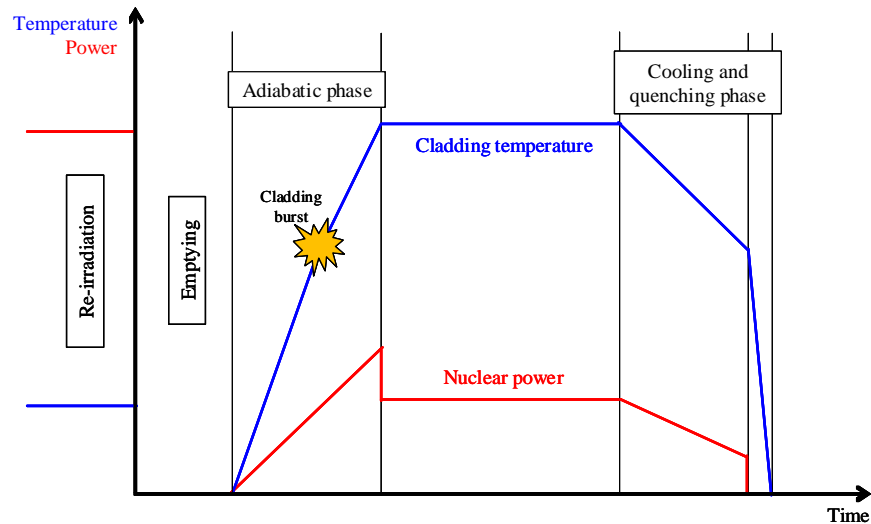

Figure 11: Phases of the LOCA sequence

## 5. Conclusion

The Jules Horowitz reactor is under construction at the CEA/Cadarache centre (France) with a target of commission by the end of this decade. Then JHR prepares to be a key infrastructure in the european and international research area for R&D in support to the use of nuclear energy during this century

This paper gives an overview of the JHR experimental irradiation capacity, and presents in particular the main material and fuel hosting systems currently under design and development. Some of them will be available at the JHR start-up: ADELIN, MADISON, MICA and NDE stands.

## 6. References

- [1] G. Bignan et al., "The Jules Horowitz research Reactor: a new high performance Material Testing Reactor working as an international user facility", International Group On Research Reactors (IGORR), 17-21 Nov., 2014, Bariloche, Argentina
- [2] D. Parrat and al., "The future underwater neutron imaging system of the Jules Horowitz MTR: an equipment improving the scientific quality of irradiation programs", International Group On Research Reactors (IGORR), 13-18 Oct., 2013, Daejeon, South Korea.
- [3] C. Roure et al., "NDE development for the JHR material testing reactor", ANIMMA, 23-27 June, 2013, Marseille, France.
- [4] C. Blandin and al., "LWR Fuel irradiation hosting systems in the Jules Horowitz Reactor". LWR Fuel Performance Meeting (LWRFP), 15-19 Sept. 2013, Charlotte, NC, USA