



**HAL**  
open science

## **EU-ERCOSAM PROJECT, scaling from nuclear power plant to experiments**

S. Benteboula, J. Malet, A. Bleyer, A. Bentaib, D. Paladino, S. Guentay, M. Andreani, I. Tkatschenko, J. Brinster, F. Dabbene, et al.

► **To cite this version:**

S. Benteboula, J. Malet, A. Bleyer, A. Bentaib, D. Paladino, et al.. EU-ERCOSAM PROJECT, scaling from nuclear power plant to experiments. ICAPP 2015 - International Congress on Advances Nuclear Power Plants, May 2015, Nice, France. cea-02509265

**HAL Id: cea-02509265**

**<https://cea.hal.science/cea-02509265>**

Submitted on 16 Mar 2020

**HAL** is a multi-disciplinary open access archive for the deposit and dissemination of scientific research documents, whether they are published or not. The documents may come from teaching and research institutions in France or abroad, or from public or private research centers.

L'archive ouverte pluridisciplinaire **HAL**, est destinée au dépôt et à la diffusion de documents scientifiques de niveau recherche, publiés ou non, émanant des établissements d'enseignement et de recherche français ou étrangers, des laboratoires publics ou privés.

## EU-ERCOSAM PROJECT

### Scaling from Nuclear Power Plant to experiments

S. Benteboula<sup>3</sup>, J. Malet<sup>1</sup>, A. Bleyer<sup>1</sup>, A. Bentaib<sup>1\*</sup>, D. Paladino<sup>2</sup>, S. Guentay<sup>2</sup>,  
M. Andreani<sup>2</sup>, I. Tkatschenko<sup>3</sup>, J. Brinster<sup>3</sup>, F. Dabbene<sup>3</sup>, S. Kelm<sup>4</sup>, H.-J. Allelein<sup>4</sup>,  
D.C. Visser<sup>5</sup>, S. Benz<sup>6</sup>, T. Jordan<sup>6</sup>, Z. Liang<sup>7</sup>, A. Kiselev<sup>8</sup>, T. Yudina<sup>8</sup>, A. Filippov<sup>8</sup>,  
A. Khizbullin<sup>9</sup>, M., Kamnev<sup>9</sup>, A. Zaytsev<sup>10</sup>, A. Loukianov<sup>10</sup>

<sup>1</sup>*Institut de Radioprotection et de Sûreté Nucléaire, 92269 Fontenay-aux-Roses, France*

<sup>2</sup>*Paul Scherrer Institut, CH-5232 Villigen PSI Switzerland*

<sup>3</sup>*CEA, Saclay, F-91191 Gif-sur-Yvette Cedex - France*

<sup>4</sup>*Forschungszentrum Jülich, 52425 Jülich, Germany*

<sup>5</sup>*Nuclear Research and Consultancy Group, 1755 Le Petten, Netherlands*

<sup>6</sup>*Karlsruher Institut für Technologie, 76131 Karlsruhe, Germany*

<sup>7</sup>*Atomic Energy of Canada Limited, 2251 Speakman Drive, Mississauga, ON, L5K 1B2, Canada*

<sup>8</sup>*Nuclear Safety Institute of the Russian Academy of Sciences, Moscow 115191, Russian Federation*

<sup>9</sup>*JSC "Afrikantov OKB Mechanical Engineering", Nizhny Novgorod, 603074, Russian Federation*

<sup>10</sup>*SSC RF-IPPE, 1 Bondarenko Sq., Obninsk, Kaluga Region, 249033, Russian Federation*

\*Contact author: Tel: + 33-1-58359854; Fax: + 33-1-46572274;

\*E-mail: ahmed.bentaib@irsn.fr

Abstract – In case of a severe accident in a light water nuclear reactor, hydrogen would be produced during reactor core degradation and released into the reactor building. The stratification of the released hydrogen in the reactor containment could lead to local pockets of gas mixtures of high hydrogen concentration and, in case of combustion, to high pressure loads which might challenge the containment structural integrity.

The objectives of ERCOSAM and SAMARA projects, co-funded by the European Union and the Russia, are to investigate hydrogen concentration build-up and break-up due to safety components operations, as sprays, coolers and Passive Auto-catalytic Recombiners (PARs).

For this purpose, various experiments addressing accident scenarios scaled down from existing plant calculations to different thermal-hydraulics facilities (TOSQAN, MISTRA, PANDA, SPOT) are considered. This paper describes the work performed in framework of the workpackage WP1 of the ERCOSAM project and presents the adopted methodology to scale down the real plant calculations results, provided by the projects partners, to the experimental facilities.

## 1. INTRODUCTION

During severe accidents (SA) in a nuclear power plant, hydrogen can be produced from exothermal oxidation of fuel cladding or fuel assembly canisters, other hot metallic components, and molten core concrete interaction (MCCI) after failure of the reactor pressure vessel and melt relocation to the reactor pit if an in-vessel retention strategy is not considered. A large amount of carbon monoxide may also be produced during MCCI in addition

to hydrogen and other gases. The hydrogen released into the containment via a reactor cooling system (RCS) break or through the pressurizer safety valves or during corium-concrete interaction is transported by convection loops arising essentially from the released hot steam/gas or initiated by condensation of steam on cold walls. Depending on the level of mixing in the containment atmosphere, the distribution of hydrogen can be homogeneous or stratified. If considerable hydrogen stratification exists, local concentration of hydrogen and carbon monoxide

may become a safety concern because pockets of high hydrogen and carbon monoxide concentrations may lead to flame acceleration (FA) or deflagration to detonation transition (DDT) if the combustible mixture is ignited. Moreover, the hydrogen distribution may be affected by engineering safety systems as spray or coolers which are widely used in many reactors to limit the containment pressure and to provide heat removal by steam condensation on water droplets or cold surfaces. These measures may homogenize the hydrogen distribution in the containment due to enhanced mixing, but they can also significantly reduce the steam concentration, which may lead to more sensitive gas mixture compositions.

The objectives of ERCOSAM project are two folds: one is to establish whether in a test sequence representative of a severe accident in LWR, well chosen from existing plant calculations, a hydrogen stratification can be established during part of the transient starting from the initiation of the loss of coolant accident (LOCA) blowdown until the end of bulk hydrogen release from the reactor vessel into the containment, and the second is how this stratification can be broken up by the operation of safety systems as sprays, coolers and Passive Auto-catalytic Recombiners (PARs).

For this purpose, the approach followed in this project starts by analysing the simulation results of representative severe accident scenarios on different nuclear power plants. The simulation results are then scaled down to define initial and boundary conditions for experiments to be performed in facilities of different scales. The experimental results thus obtained are then extrapolated to real scale applications.

This paper presents the work performed in framework of work package WP1 of the ERCOSAM project, dealing with the analysis of the available real plant calculations, the selection of sequences representative of severe accident likely to lead to hydrogen stratification and the scaling down methodology.

Thus, the first part will be dedicated to the analysis of the scenarios provided by the project partners. These scenarios are analyzed to select relevant data leading to relatively high hydrogen concentrations. In the second part, a generic NPP containment is then build based on the reactor containment characteristics provided by the partners. In the last part, the selected scenarios are simulated based on the generic containment to provide representative initial and boundary conditions for experiments and the impact of mitigation means is investigated.

## 2. Scenarios analysis

More than 350 severe accident scenarios corresponding to four different reactors have been provided by the project partners. The following table summarizes the main characteristics of the considered reactor containments

**Table 1: Real plants characteristics**

	W- PWR1130 (PSI)	PWR900 (IRSN)	VVER1000 (IBRAE)	PWR13 00 (IRSN)
Power P (MWth)	1130	2700	3000	3900
Free volume V (m <sup>3</sup> )	36 110	48 055	62 080	71 640
Concrete surface Sc (m <sup>2</sup> )	7349	7597	17986	17726
Steel surface Ss (m <sup>2</sup> )	4055	18446	3645	7597
Total surface S (m <sup>2</sup> )	11404	26043	21631	25323
V/P (m <sup>3</sup> /MW)	31.96	17.8	20.69	18.37
V/S (m)	3.17	1.85	2.87	2.83

The scenarios provided by the project partners are:

### IRSN scenarios

251 sequences for PWR 900 (see [2], [3], [4] and [5]) and 105 sequences for PWR 1300 (see [6], [7] and [8]), involving different accident situations with application or not of the SAM actions. Calculations have been performed with ASTEC CPA code.

### PSI scenarios

Three LOCA scenarios with different break diameters without mitigation calculated with MELCOR 1.8.5 code.

### IBRAE scenarios

One small break LOCA calculated for coarse and fine nodalizations without and with recombiners with SOCRAT/KUPOL code.

To select the relevant scenarios potentially leading to hydrogen stratification, the following criteria were adopted:

- The first criterion consists in selecting scenarios leading to high PAICC (pressure generated by a complete adiabatic and isochoric combustion).
- The second criterion adopts the classification introduced in [9], based on total mass and mass flow rate of hydrogen released in the containment. Thus, scenarios of interest are characterized by high hydrogen total mass ( $M \geq 500 \text{ kg}$ ) and high hydrogen mass flow rate ( $\dot{M} \geq 0.15 \text{ kg/s}$ ).

In addition to the mentioned criteria, the mass-to-power ratio ( $M/P$ ) and the mass-to-volume ratio ( $M/V$ ) are compared for each scenario. For the sake of “similarity”, the selected scenarios representing each reactor configuration have close values of ( $M/V$ ) and ( $M/P$ ) ratios. These scenarios represent group of accident scenarios that would have similar accident kinetics and generate similar loads, so resulting in a similar event progression

### 3. Definition and scaling of the generic containment

The generic containment is defined to correspond to a fictive reactor of 1000 *MWth* with regard to the scenarios data associated to their corresponding NPP configurations. Then, to determine the volume of the generic

containment, the volume-to-power ratio ( $V/P$ ) and the volume-to-structures surface ratio ( $V/S$ ) are compared for each NPP in Table 1. Accordingly, a chosen average value of the ( $V/P$ ) ratio equal to 20 gives a containment volume of  $20000 \text{ m}^3$ .

The general specifications of the generic containment are defined on the basis of PWR 1300 reactor. The reactor building is double concrete walls and the structures are modeled with three materials: steel for metallic structures, prestressed concrete for the internal wall of the containment and reinforced concrete for the raft and the other walls of the containment.

The geometry, nodalization and structures of the generic containment are deduced by scaling down data from PWR 1300. So, the generic containment is discretized with 17 compartments as shown in Figure 1.

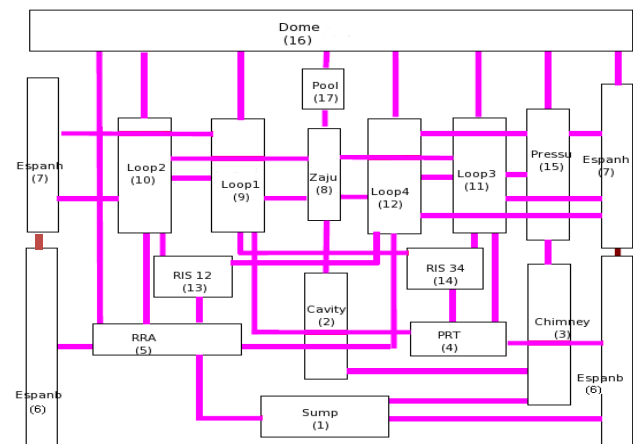


Figure 1 Generic containment nodalization with 17 compartments

Gas and liquid transfers between the containment compartments are modeled with 45 atmospheric and 29 liquid junctions.

#### 3.1 Scaling down procedure

To get a general scaling of the containment, the controlling processes such as mass and energy

transfer taking place between compartment volumes through atmospheric and liquid junctions and also on walls and components structure, have to be considered. For this purpose, the scaling approach is time preserving in order to ensure proper scaling of the masses, mass flow rates and enthalpy flow rates. This means that the generic and the real scenario time scales are identical.

For preserving the rate of change of the containment pressure, the scaling parameter is the ratio between the generic “G” and the real “R” containment volumes  $\lambda^3 = V_G / V_R$ . So we consider that,  $t_G / t_R = 1$  and  $\lambda^3 = V_G / V_R$ . This leads for  $h_G / h_R = 1$  to  $\dot{M}_G / \dot{M}_R = \dot{Q}_G / \dot{Q}_R = \lambda^3$ , where  $h$  the specific enthalpy,  $\dot{M}$  the mass flow rate and  $\dot{Q}$  the enthalpy flow rate. The structures surfaces  $S_w$  are scaled with  $\lambda^3$  to preserve the free volume to structure surfaces ratio  $V/S$ , between the generic and the real containments, which is involved in mass and heat exchanges.

Mass flow rates and enthalpy flow rates for released hydrogen, steam and water are scaled with the volume ratio  $\lambda^3$ . Here  $\lambda^3$  is determined for each scenario by using the associated real NPP volume.

**Table 2: Scaling of generic containment**

Quantity	Scaling rule
Zone volume	$\lambda^3$
Zone area	$\lambda^2$
Structure wall surface	$\lambda^3$
Junction lengths, wall thickness	$\lambda$

**Table 3: Scaling of to scenarios source terms**

Quantity	Scaling rule
Time	1
Mass flow rate	$\lambda^3$
Specific enthalpy	1

### Scaling recombiners

PARs are devices consisting of catalyst surfaces arranged in an open-ended enclosure. In the presence of hydrogen, a catalytic reaction occurs spontaneously at the catalyst surfaces and the heat of reaction produces natural convection flow through the enclosure, exhausting the warm, humid air and drawing fresh gas from below. In the generic containment, AECL recombiners without and with chimney are considered similarly the PWR 1300. The recombination rate is given by AECL correlation as:

$$\frac{dm_{H_2}}{dt} = -f(v) P_{tot}^{0.57769} \left( \frac{298}{T} \right)^{1.10974}, \text{ where } f(v) \text{ is}$$

a polynomial piecewise function, of hydrogen molar fraction,  $m_{H_2}$  is the hydrogen mass in the containment,  $P_{tot}$  the total pressure and  $T$  the gas temperature in the containment.

The recombination rate, in the generic containment is obtained by scaling with the volumetric ratio  $\lambda^3$ . The distribution of the recombiners therein is similar to that in PWR 1300 configuration.

### Scaling spray system

The plants are equipped with spray systems in order to reduce the pressure and to wash-out fission products and iodine in the containment in the case of severe accident. Spray system typically consists of two trains, each with two pumps and valves to control the flow of water to the containment spray system. The spray systems operate in two phases: a direct spray phase in which borated water is sucked up from the refueling water storage tank RWST, and injected to several spray headers in the top of the containment, and a recirculation phase in which the injected water is collected in the sump and injected again in the top of the dome.

The spray system of the generic containment is similar to the PWR 1300 one and is automatically activated when the containment pressure exceeds the threshold value of 2.6 bars. Thus, for scaling down the spray system, the RWST volume, pumps and heat exchangers characteristics (flow

rates, sections, elevations ...) are reduced with respect to the geometric scaling ( $\lambda^3$ ,  $\lambda^2$  and  $\lambda$ ). The droplet characteristics are kept identical to those in PWR 1300.

### 3.2 Validation of the scaling procedure on a reference scenario

In order to validate the proposed scaling procedure, a LOCA scenario corresponding to an intermediate diameter of 4" is considered. The break is located on the cold leg of the primary loop2 at low release elevation. The considered mass flow and enthalpy flow rates of hydrogen and steam are presented in Figure 2a and 2b.

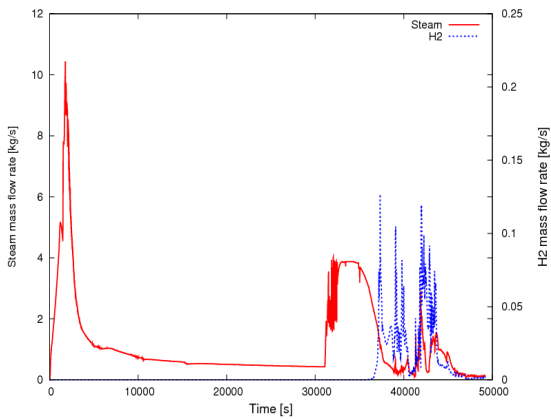


Figure 2a Mass flow rate of steam and hydrogen

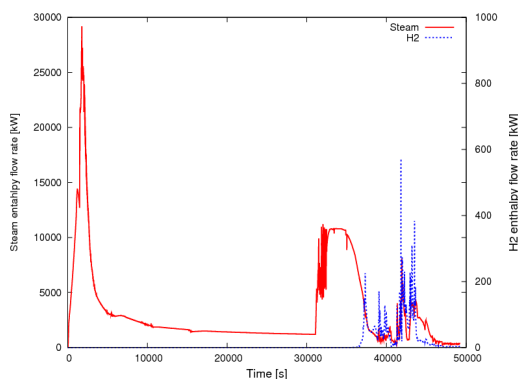


Figure 2b Enthalpy flow rate of steam and hydrogen

To evaluate the validity of the scaling down procedure, both global and local variables have

obtained on the real and generic cases have been compared. Thus, total pressure (Figure 3), the gas temperature (Figure 4) and the hydrogen and steam volume fractions (Figure 5a and Figure 5b) in three compartments of different heights which are the pressurized relief tank (PRT 2.68 m), the loop 2 (11 m) and the dome (28.6 m) have been compared. Very good agreement is obtained between the reference and generic calculations for each compartment and during the whole scenario. Hence, the scaling procedure adopted can be considered as validated.

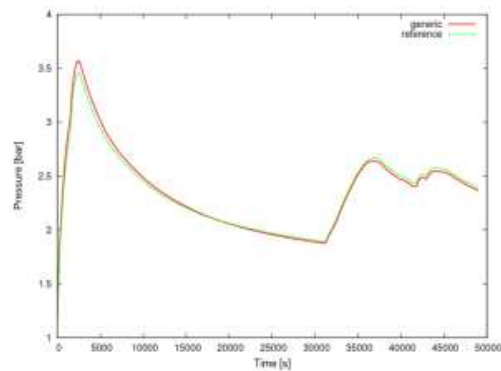


Figure 3 Comparison of containment pressure

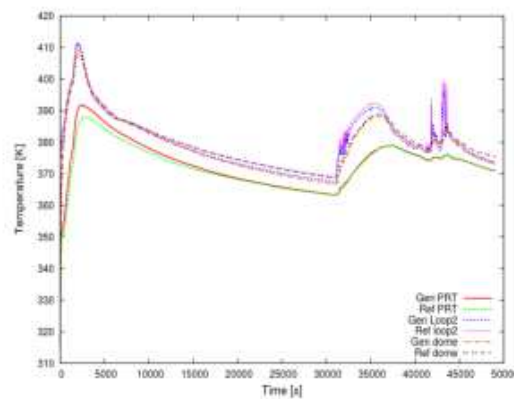
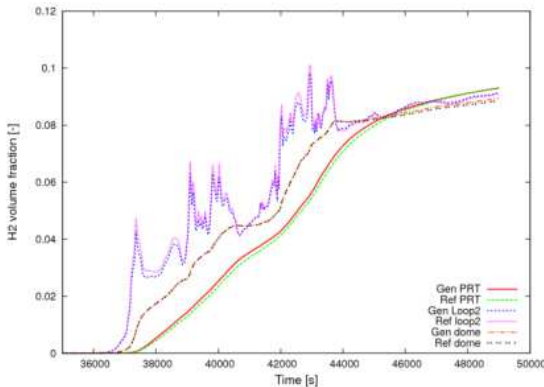
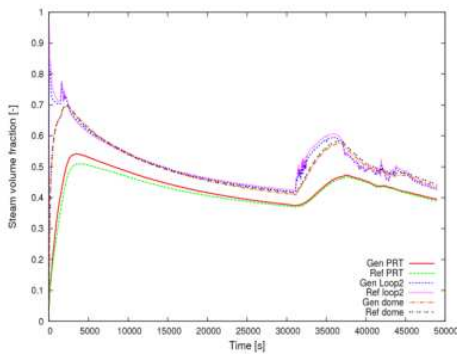


Figure 4 Comparison of gas temperature in the dome; loop2 and PRT for reference and generic containment



**Figure 5a Comparison of the hydrogen volume fraction in the dome, loop2 and PRT for reference and generic containment calculations**



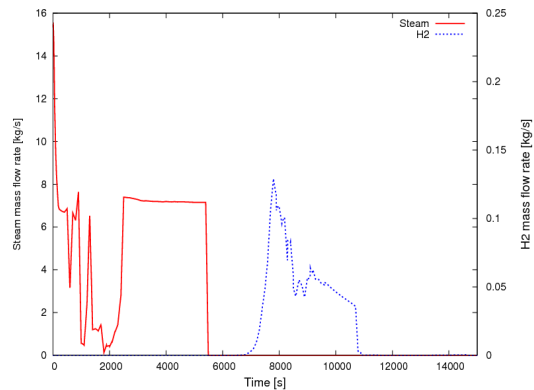
**Figure 5b Comparison of the steam volume fraction (right) in the dome, loop2 and PRT for reference and generic containment calculations**

After the validation of the adopted scaling down procedure on an intermediate break LOCA scenario, an intensive analysis of the selected scenarios was performed. Hereafter, an example of the performed analysis is described.

#### 4. Analysis of a small break LOCA scenario on the generic containment

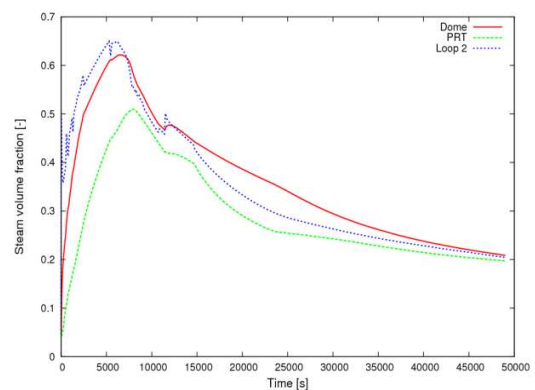
The considered scenario corresponds to a small break LOCA of 1.5" diameter [4]. This scenario is chosen because it presents interesting features such as fast release kinetics and high hydrogen concentrations. Figure 6 shows the corresponding

scaled mass flow rates of injected steam and hydrogen.

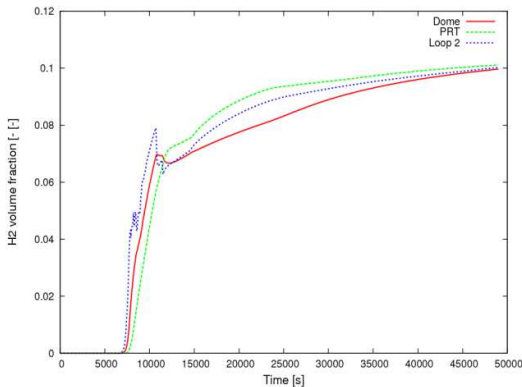


**Figure 6 Mass flow rate of steam and hydrogen released in the containment**

This scenario was first calculated by considering the containment model within 17 compartments. As can be seen in Figures 7a and 7b, the volume fractions of both steam and hydrogen are almost homogeneous in the three compartments especially for hydrogen despite their different elevations (PRT 2.68 m, loop2 11 m and dome 28.6 m). This homogenization is mainly due to the use of lumped-parameter code (ASTEC) with coarse nodalization (17 compartments).

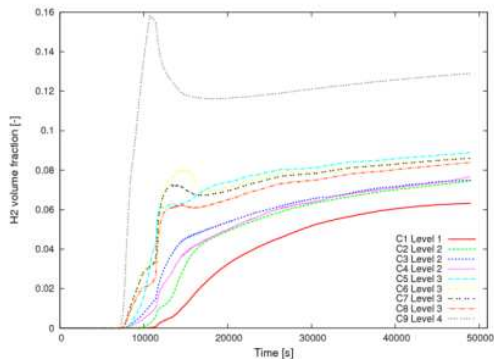


**Figure 7a: Time evolution of the hydrogen volume fraction in three different compartments**

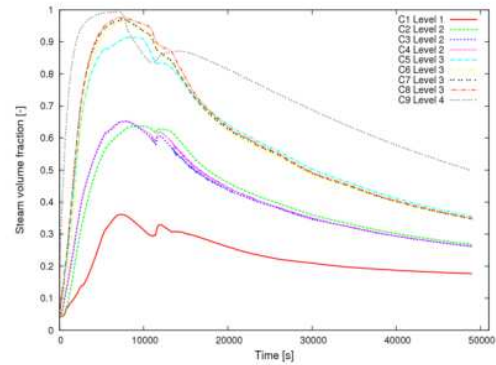


**Figure 7b:** Time evolution of the steam volume fraction in three different compartments

To overcome these limitations, the dome zone was subdivided into 9 new zones within four horizontal layers and the break location was considered in the dome area. Within the new nodalization, the gas stratification was observed as shown in Figures 8a and 8b.



**Figure 8a** Time evolution of volume fraction of hydrogen in different compartments for generic containment calculations



**Figure 8b** Time evolution of volume fraction of steam in different compartments for generic containment calculations

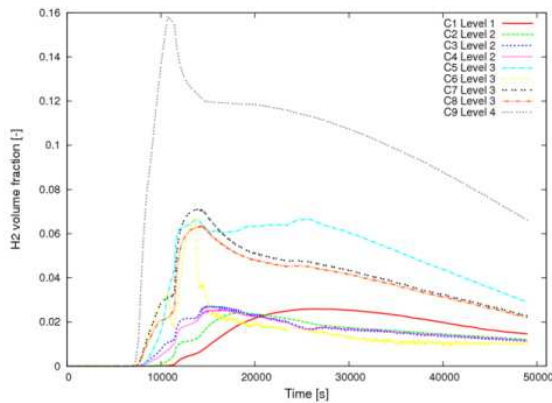
Once the stratification established, the effect induced by PARs and Spray operation was investigated.

#### 4.1 PARs effect

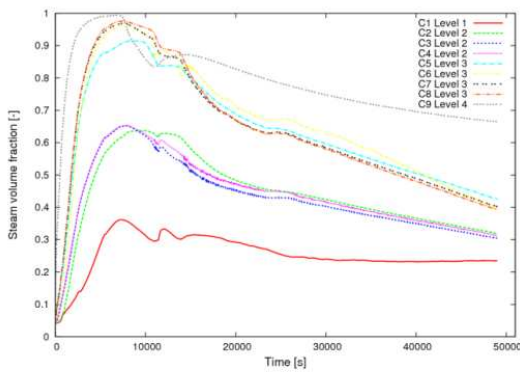
To analyze the effect of recombiners on gas composition in the containment, the previous scenario was simulated taking into account recombiners located in different compartments of the containment.

Results showed that PARs reduce drastically the amounts of hydrogen in the containment by recombination. Regarding the gas composition, the local concentrations of hydrogen and steam in the dome compartments are shown in Figures 9. As the scenario progresses, the hydrogen concentration (Figure 9 a) considerably decreases in the dome compared to the case without recombiner (Figure 8a). The steam volume fraction is therefore larger as the steam mass is increased by recombination (see Figure 9b).



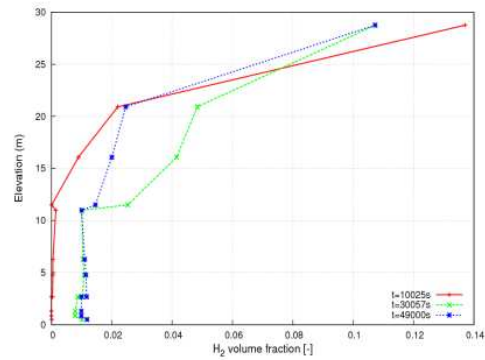


**Figure 9a** Time evolution of volume fraction of hydrogen in different compartments of the dome for generic containment calculations

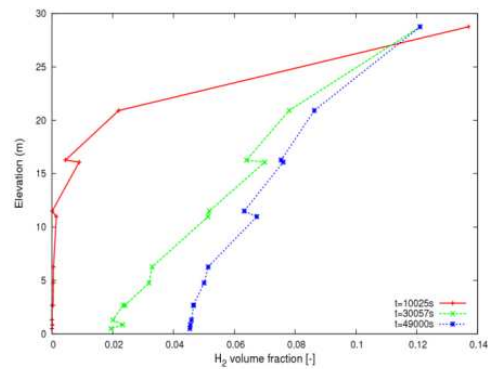


**Figure 9b** Time evolution of volume fraction of steam in different compartments of the dome for generic containment calculations

To illustrate the impact of recombiners on the hydrogen concentration gradients, the vertical distribution of the hydrogen volume fraction is shown in Figure 10a and 10b, at each level of the containment, at three different times of the scenario corresponding to: the early hydrogen injection time ( $t = 10025\text{ s}$ ), after the end of hydrogen discharge ( $t = 30057\text{ s}$ ) and at the end of the sequence duration.



**Figure 10a** Vertical distribution of hydrogen volume fraction in the containment without PAR at three different times during and after hydrogen release



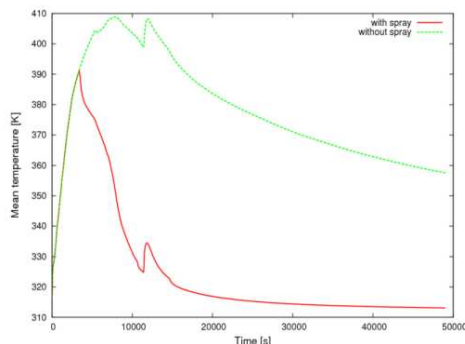
**Figure 10b** Vertical distribution of hydrogen volume fraction in the containment with PARs at three different times during and after hydrogen release

Figures 10 show that the hydrogen concentration increases with respect to compartment elevation, higher concentrations are located in the upper compartments of the dome for both cases without and with PARs. For the case without recombiner (Figure 10a), at  $t = 10025\text{ s}$ , large concentration differences are observed between the dome compartments. In the lower compartments there is not yet hydrogen, concentration is almost zero. As the scenario progresses in time, at  $t = 30057\text{ s}$ , the concentration gradients are more uniform and the concentration distribution is nearly linear.

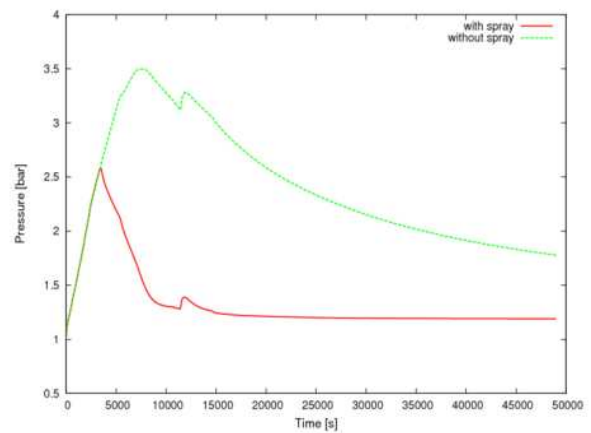
At the end of the sequence, hydrogen distribution tends slowly to homogenization since the concentration gradients are fairly reduced. In the case with PARs (Figure 10b), the first feature to be noticed is the homogenization of the hydrogen distribution in the low location compartments for elevation less than 11 m where the hydrogen concentration is almost constant. At  $t = 10025 s$ , the vertical distribution of hydrogen concentration is not modified which means that recombination is not operating yet. Except in the topmost compartment “C9 level 4” where the hydrogen concentration is still high, smaller values of the concentration are observed in the compartments below. The hydrogen distribution tends to homogenization as the scenario progresses in time especially at the end of the sequence.

#### 4.2 Spray system effect

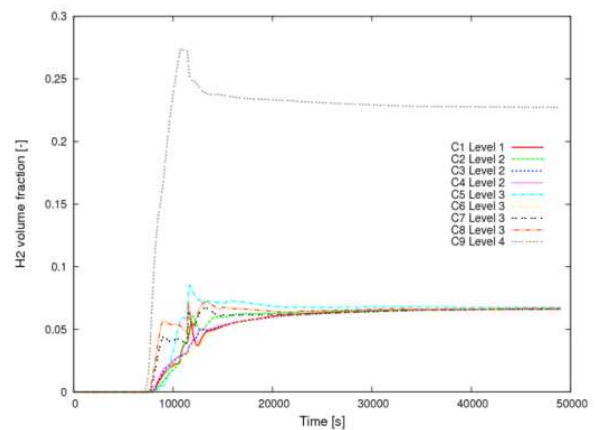
Spray system of the generic containment is activated as soon as the containment pressure reaches 2.6 bar. As can be seen from Figure 11, the activation of the spray system leads to quasi-instantaneous pressure drop to stabilize afterwards to a constant value about 1.2 bar. The pressure drop is due to steam condensation on water droplets. The pressure decrease is accompanied with significant fall of temperature compared to the same scenario without spray, as shown in Figure 12.



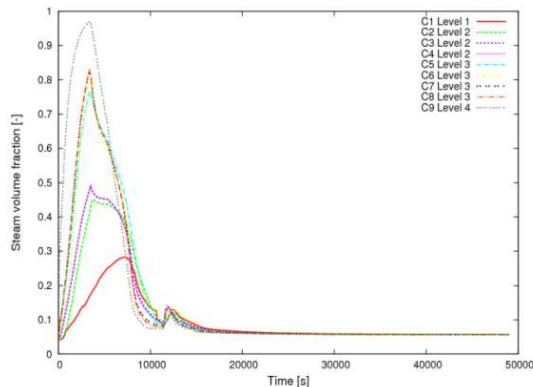
**Figure 11 Comparison of the containment pressure with and without spray system**



**Figure 12 Comparison of the mean gas temperature with and without spray system**



**Figure 13 Time evolution of the hydrogen volume fraction of hydrogen in the dome compartments with spray system activated**



**Figure 14 Time evolution steam in the dome compartments with spray system activated**

The spray down activation leads to homogenization of hydrogen concentration in the whole containment except in the upper zone of the dome. Large disparity is noticed on the hydrogen concentration (about 15%) between the upper compartment and the other compartments of the containment (see Figure 13). In Figure 14, the steam volume fraction is significantly reduced by condensation on spray droplets. Except the upper compartment, homogenization of concentration distribution takes place in all compartments of the containment for both hydrogen and steam.

## 5. Conclusion

In this work, several plant calculations of severe accident sequences provided by ERCOSAM project partners have been analyzed. The collected scenarios calculations represent four different NPP configurations: 356 scenarios from level 2 PSA PWR 900 and PWR 1300 (IRSN), 3 LOCA scenarios from W-PWR 1130 calculations (PSI) and 1 SBLOCA scenario from VVER-1000 (IBRAE). Selection of representative severe accident scenario among the given calculations results has been carried. The strategy adopted for relevant scenario selection relies on the hydrogen risk in terms of hydrogen mass and mass flow rate release and on the flammability limits

criteria. The existing NPPs characteristics have been used to define the containment of a generic NPP of 1000 *MWth*. The generic containment nodalization has been determined by scaling down from PWR 1300 configuration.

The scaling down procedure, for the generic containment geometry and nodalization, is based on the ratio between the generic and the PWR 1300 containment volumes. For source terms, the scaling relies on a time preserving approach between generic and real scenarios. The mass and enthalpy flow rates are scaled using the volume ratio corresponding to each containment volume.

Validation of the generic containment scaling down from real plant is performed through new calculations of the selected scenarios with the corresponding scaled source terms on the generic containment. Comparisons of the generic calculations results with the reference plants ones show that generic calculations provide the expected behavior in terms of predicted pressure and temperature in the containment and also of global and local steam and hydrogen quantities such as mass and concentrations.

Particular attention is given to the hydrogen build up concentration. In order to achieve conditions that allow predicting hydrogen “stratification” with lumped-parameter ASTEC CPA code, new nodalization of the dome is proposed and hydrogen-steam gases are supposed to be injected at high level position. In that way, significant gradient of hydrogen and steam concentration can be observed in the containment with respect to the vertical position.

The impact of mitigation means, PARs and spray system, on the generic containment thermalhydraulics, in particular on the hydrogen distribution, are investigated. The PARs recombination rates and distribution as well as the spray system characteristics have been adapted to the generic containment similarly to

the PWR 1300 configuration. The presence of PARs allows reducing considerably the in-containment hydrogen mass and modifies the hydrogen distribution with tendency to homogenization as the sequences progress in time. Regarding the spray system, results show that its activation leads to significant pressure drop in the containment as expected and except the topmost compartment homogenization of hydrogen and steam concentration is established in the whole containment.

The scaling for the cooler was not performed for the generic containment, because the reference design does not include this component. For the experiments, the cooling power was determined using a volumetric scaling law and the operating conditions of the coolers in a CANDU reactor [13].

The procedure adopted was used in the WP2 to scale down the results from the generic containment to facilities scale to define initial and boundary conditions. Thus, the initial proposal for initial and boundary conditions for the reference scenario was made within WP1. In WP2, the "modified scenario" was defined, with some changes in configurations, initial conditions and parameters for injections and operation of the components.

## 6. References

- [1] *Containment thermal-hydraulics of current and future LWRs for severe accident management*. Annex I - "Description of Work". THEME: Fission-2009-7.0.3.
- [2] A. PIERRACHE & A. BENTAÏB: *Modèle hydrogène pour l'EPS2. Impact des recombineurs sur le risque hydrogène dans l'enceinte de confinement des REP 900 MWe: Volume I: Synthèse des résultats*, NT DPEA/SEAC/2000-035. PROJET EPS2/REP 900/NS2-02-14.
- [3] L. BELLENFANT-FONTENEL : *Résultats des calculs de dégradation du cœur des séquences avec actions GIAG avec le codes VULCAIN/CPA (ASTEC V0.43-beta)*. Tome 1 : Fiche Technique DSR/SAGR/2005-147. Tome 2 : Fiche Technique DSR/SAGR/2005-148.
- [4] D. PLASSART : *Synthèses des calculs de dégradation du cœur avec les codes VULCAIN/CPA (ASTEC V0.4). Etats initiaux des réacteurs en puissance et arrêt intermédiaire diphasique sous P11*. NT DSR/SAGR/2006-124. PROJET EPS2/REP900/NS2/06-1.
- [5] D. PLASSART : *Synthèses des calculs de dégradation du cœur avec les codes VULCAIN/CPA (ASTEC V0.43-beta). Etats initiaux des réacteurs à l'arrêt*. NT DSR/SAGR/2006-127. PROJET EPS2/REP900/NS2/06-21.
- [6] E. LECLERC : *Synthèse des calculs de dégradation du cœur avec le code ASTEC VI. 3R3p1 pour les états initiaux en puissance et avec application des actions GIAG*. Rapport DSR/SAGR/2009-56. PROJET EPS2/REP 1300/NS-09-07.
- [7] E. LECLERC : *Synthèse des calculs de dégradation du cœur avec le code ASTEC VI. 3R3p1 pour les états initiaux en puissance et sans actions GIAG*. Rapport DSR/SAGR/2009-55. PROJET EPS2/REP 1300/NS-09-06.
- [8] A. BENTAÏB & P. PAILHORIES. *Evaluation du risque hydrogène sur le palier P'4 en vue de l'instruction du dimensionnement des recombineurs AECL*. NT DPEA/SEAC 03-040.
- [9] A. BENTAIB, C. CATALDO, B. CHAUMONT & K. CHEVALIER-JABET. *Evaluation of the impact that PARs have on hydrogen risk in the reactor containment: Methodology and application to PSA level 2*. Science & Technology of Nuclear Installations. Vol (2010), Article ID 320396.
- [10] S. GUENTAY. *Steam and Hydrogen Load to a Containment of W-PWR with 1130 MWth Size from 2", 4" and 6" LOCA Initiated Severe Accident without any Accident Management Measures*
- [11] K. DOLGANOV, A. ZAYTSEV, A. KAPUSTIN, A. KISELEV, D. TOMASHCHIK, T. YUDINA. *Results of modeling of hydrogen source and distribution under containment during severe accident at generic VVER-1000 NPP*
- [12] N. Zuber, 1991. Appendix D: *A hierarchical, two tiered scaling analysis, an integral structure and scaling methodology for severe accident technical issue resolution*. US Nuclear Regulatory Commission, Washington, DC 20555, NUREG/CR-5809, November 1991.