

DE LA RECHERCHE À L'INDUSTRIE



INFLUENCE OF A PASSIVE LAYER ON THE KINETICS OF AN ELECTRON TRANSFER REACTION

17th ISE Topical Meeting |

Christian Bataillon² ; Marie Benoit¹ ; Benoît Gwinner¹ ;
Frédéric Miserque² ; Carlos Sanchez-Sanchez³ ;
Bernard Tribollet³ ; Vincent Vivier³.

¹CEA, DEN, DANS, DPC, SCCME, Laboratoire d'Etude de la Corrosion Non Aqueuse, F-91191 Gif-sur-Yvette, France.

²CEA, DEN, DANS, DPC, SCCME, Laboratoire d'Etude de la Corrosion Aqueuse, F-91191 Gif-sur-Yvette, France.

³CNRS - UPMC, UMR 8235, Laboratoire Interfaces et Systèmes Electrochimiques, F-75252 Paris 05, France.

INDUSTRIAL CONTEXT

- Spent nuclear fuel reprocessing
 - Concentrated nitric acid environment
 - Use of stainless steel and zirconium as materials for containing concentrated nitric acid (passive materials with good corrosion/dissolution resistance in oxidizing media)

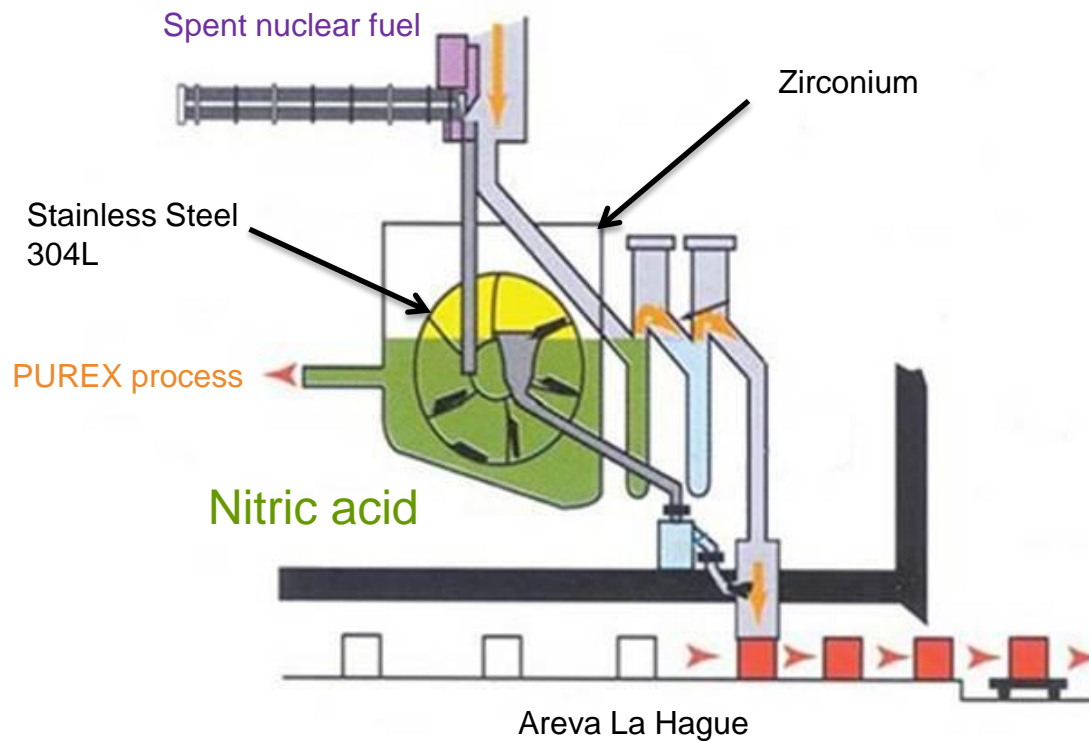

INDUSTRIAL CONTEXT

- Spent nuclear fuel reprocessing
 - Concentrated nitric acid environment
 - Use of stainless steel and zirconium as materials for containing concentrated nitric acid (passive materials with good corrosion/dissolution resistance in oxidizing media)

- Objective: Kinetics modeling of the concentrated nitric acid reduction on passive materials

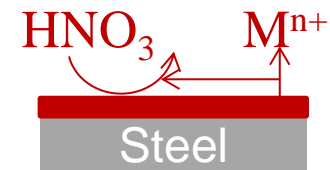

INDUSTRIAL CONTEXT

- Spent nuclear fuel reprocessing
 - Concentrated nitric acid environment
 - Use of stainless steel and zirconium as materials for containing concentrated nitric acid (passive materials with good corrosion/dissolution resistance in oxidizing media)
- Objective: Kinetics modeling of the concentrated nitric acid reduction on passive materials

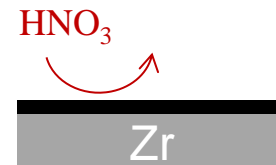

INDUSTRIAL CONTEXT

Spent nuclear fuel reprocessing

- Concentrated nitric acid environment
- Use of stainless steel and zirconium as materials for containing concentrated nitric acid (passive materials with good corrosion/dissolution resistance in oxidizing media)

Objective: Kinetics modeling of the concentrated nitric acid reduction on passive materials

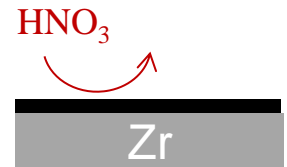
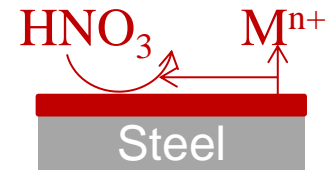
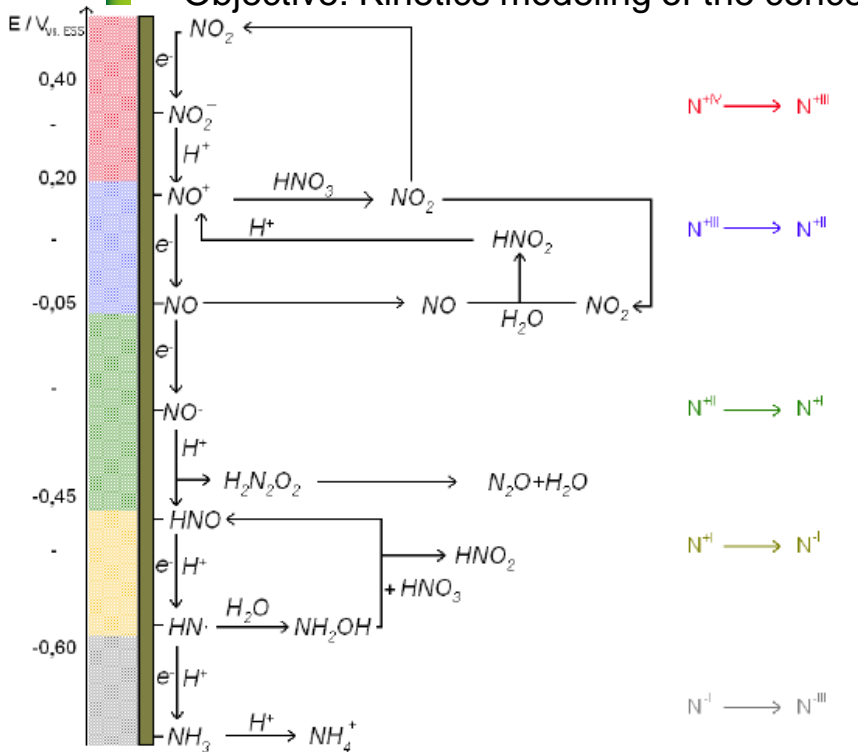

[R.Lange, Thesis 2012]

Spent nuclear fuel reprocessing

- Concentrated nitric acid environment
- Use of stainless steel and zirconium as materials for containing concentrated nitric acid (passive materials with good corrosion/dissolution resistance in oxidizing media)

Objective: Kinetics modeling of the concentrated nitric acid reduction on passive materials

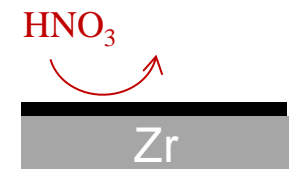
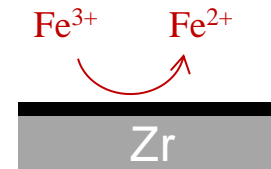
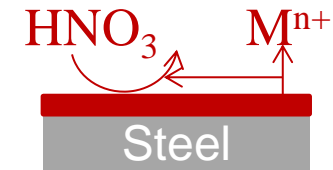
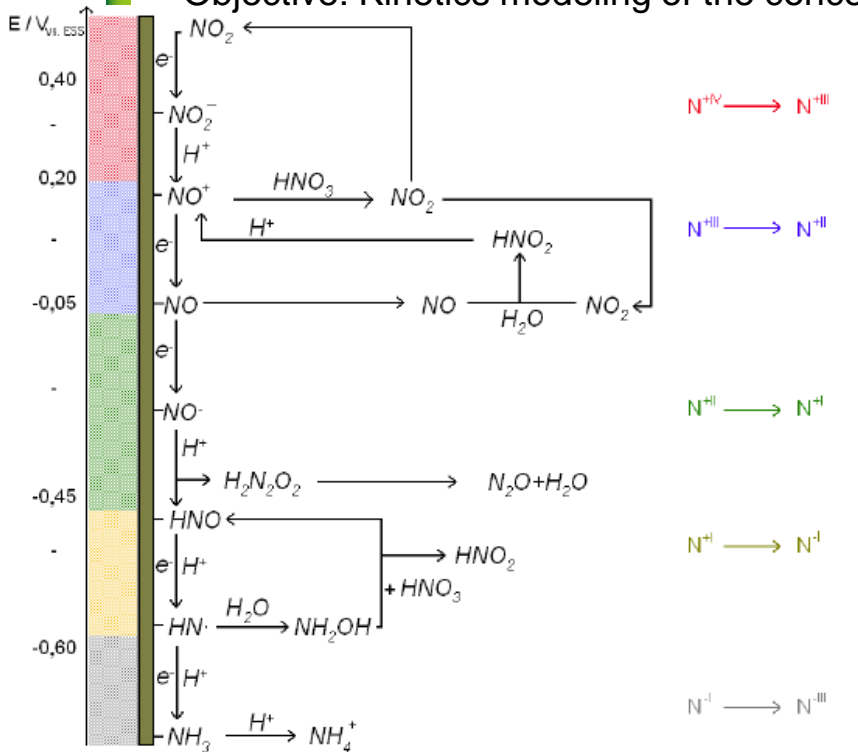

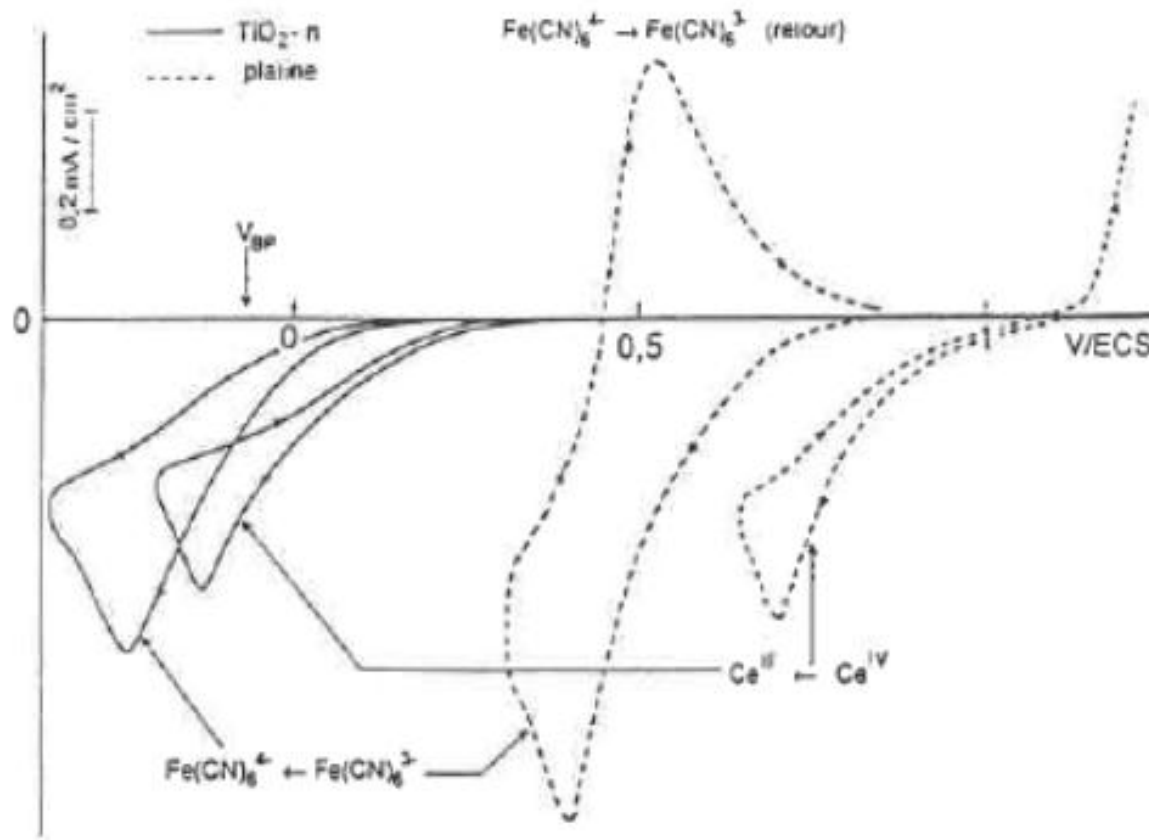

[Bard et al, J.Electrochem. Soc., 125 (1978), p246]

- The passive layer controls the flow of any electron exchange between the metal and an electrolyte
- Accordingly the charge transfer kinetics depends on passive layer properties

Objective: to study the role of the passive layer (ZrO_2) on the kinetics of reduction of Fe(III)/Fe(II) couple

Objective: to study the role of the passive layer (ZrO_2) on the kinetics of reduction of Fe(III)/Fe(II) couple

- Formation & characterization of passive layer with a controlled thickness
 - Formation of passive layer
 - Monitoring the (nanometric scaled) thickness
 - *Ex situ* method: XPS
 - *In situ* method: EIS
 - Results

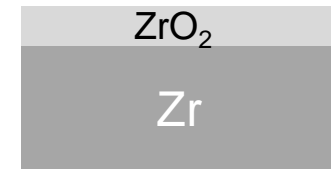

Objective: to study the role of the passive layer (ZrO_2) on the kinetics of reduction of Fe(III)/Fe(II) couple

■ Formation & characterization of passive layer with a controlled thickness

- Formation of passive layer
- Monitoring the (nanometric scaled) thickness
 - *Ex situ* method: XPS
 - *In situ* method: EIS
- Results

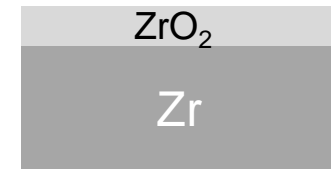

■ Study of Fe(III) reduction kinetics by EIS on a nanometric passive film

- EIS analysis
- Results

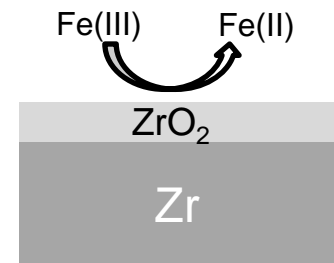

■ Conclusion and outlook

Formation of passive film

■ anodic potential polarization of the sample
in HNO₃ 4 mol/L 40°C:

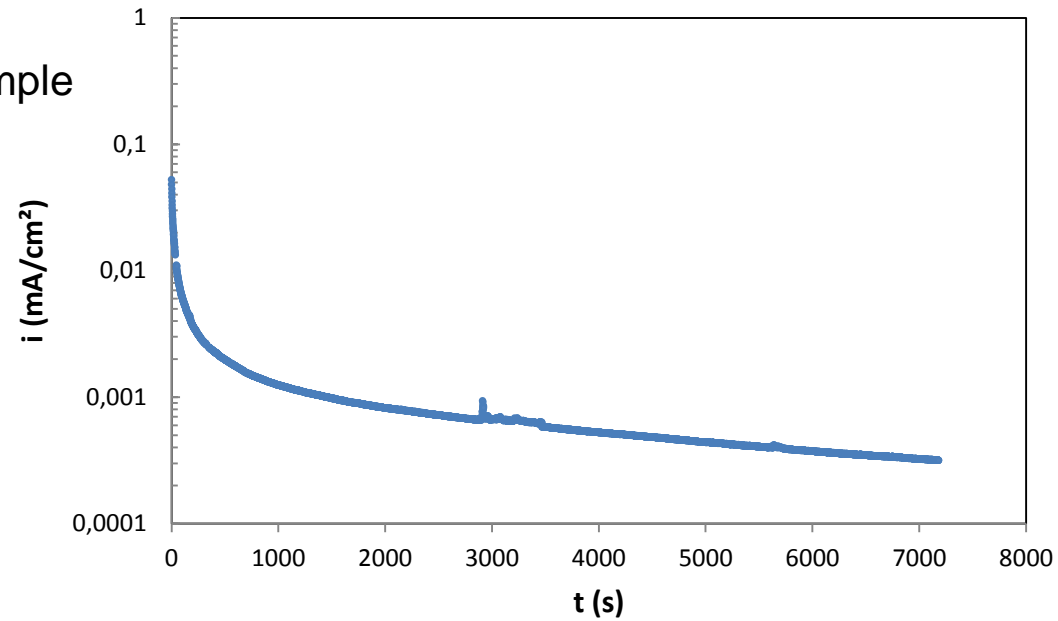

Formation of passive film

■ anodic potential polarization of the sample in HNO₃ 4 mol/L 40°C:

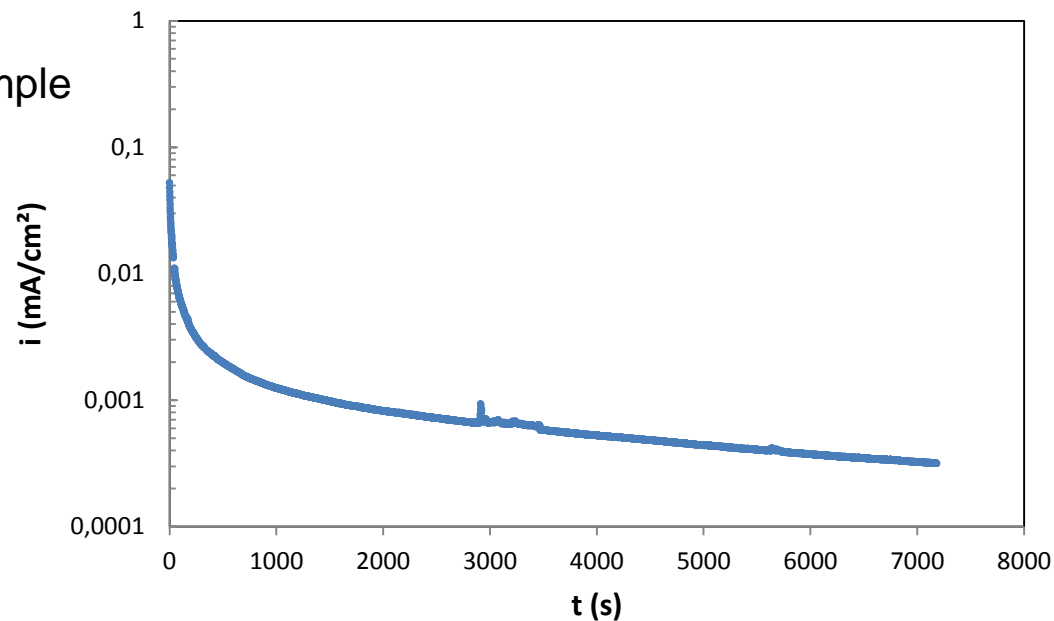

Sample	Potential of formation (V/ENH)	Time of polarization (s)
ZrM103	1,15	~940
ZrM104	Non-polarized	
ZrM105	1,15	~7200
ZrM106	1,5	~7200

Formation of passive film

■ anodic potential polarization of the sample in HNO₃ 4 mol/L 40°C:

- Characteristics of the passive film:
- chemically stable
 - little rough (<200 nm)

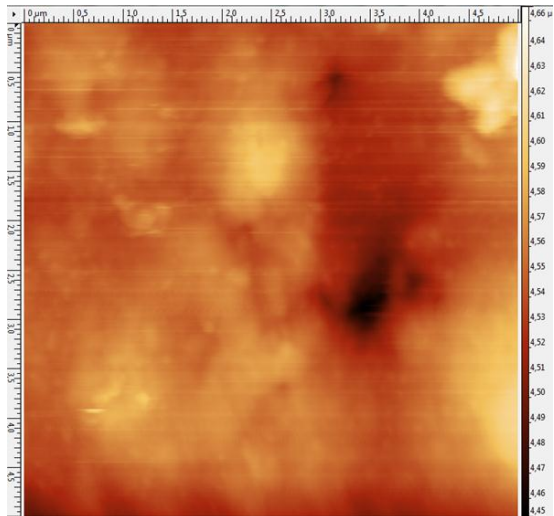

AFM

- Nanometric film thickness
 - *Ex situ*: XPS
 - *In situ*: EIS

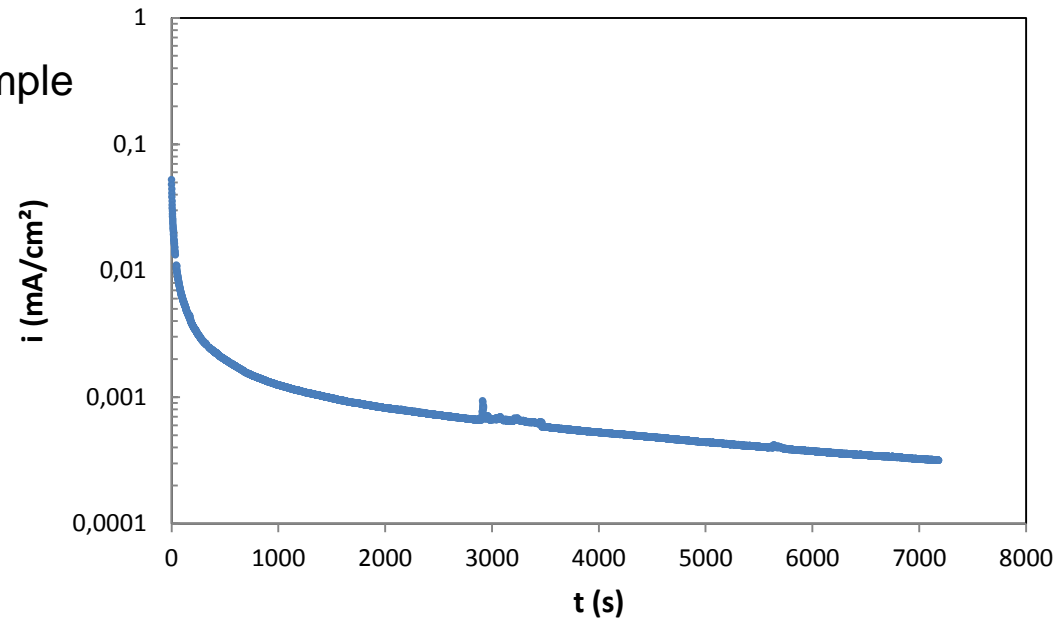

Sample	Potential of formation (V/ENH)	Time of polarization (s)
ZrM103	1,15	~940
ZrM104	Non-polarized	
ZrM105	1,15	~7200
ZrM106	1,5	~7200

XPS: Principle and parameters

- **Oxide-layer model:** metallic surface coated with a uniform oxide layer (single element)

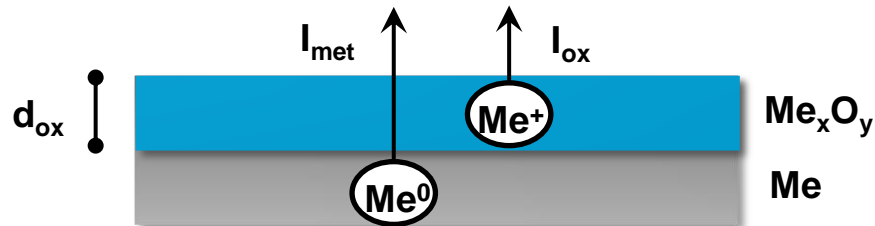

XPS: Principle and parameters

- **Oxide-layer model:** metallic surface coated with a uniform oxide layer (single element)

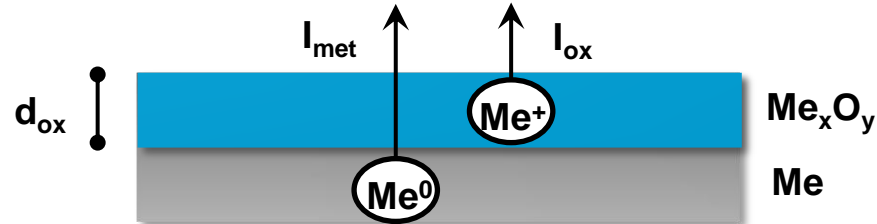

- The oxide thickness (d_{ox}) is estimated by:

$$d_{ox} = \lambda_{ox} \cos\theta \ln \left[\frac{N_{met}}{N_{ox}} \times \frac{\lambda_{met}}{\lambda_{ox}} \times \frac{I_{ox}}{I_{met}} + 1 \right]$$

XPS: Principle and parameters

- **Oxide-layer model:** metallic surface coated with a uniform oxide layer (single element)

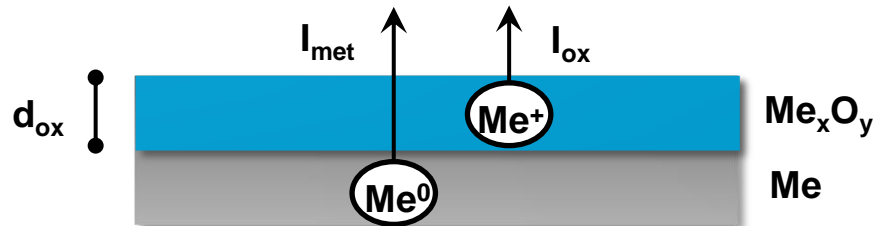

- The oxide thickness (d_{ox}) is estimated by:

$$d_{ox} = \lambda_{ox} \cos\theta \ln \left[\frac{N_{met}}{N_{ox}} \times \frac{\lambda_{met}}{\lambda_{ox}} \times \frac{I_{ox}}{I_{met}} + 1 \right]$$

- Intensities of electronic levels in metallic element (I_{met}) and oxide (I_{ox})
- Inelastic mean free path: average distance of an electron between two inelastic collisions in the metal (λ_{met}) and in the oxide (λ_{ox})
- Number of atoms per volume unit
- Angle between the sensor and the normal of the sample surface ($\cos\theta = 1$)

XPS: Parameters estimation

■ I_{ox} and I_{met} : Estimated by recomposing the spectra of Zr 3d levels

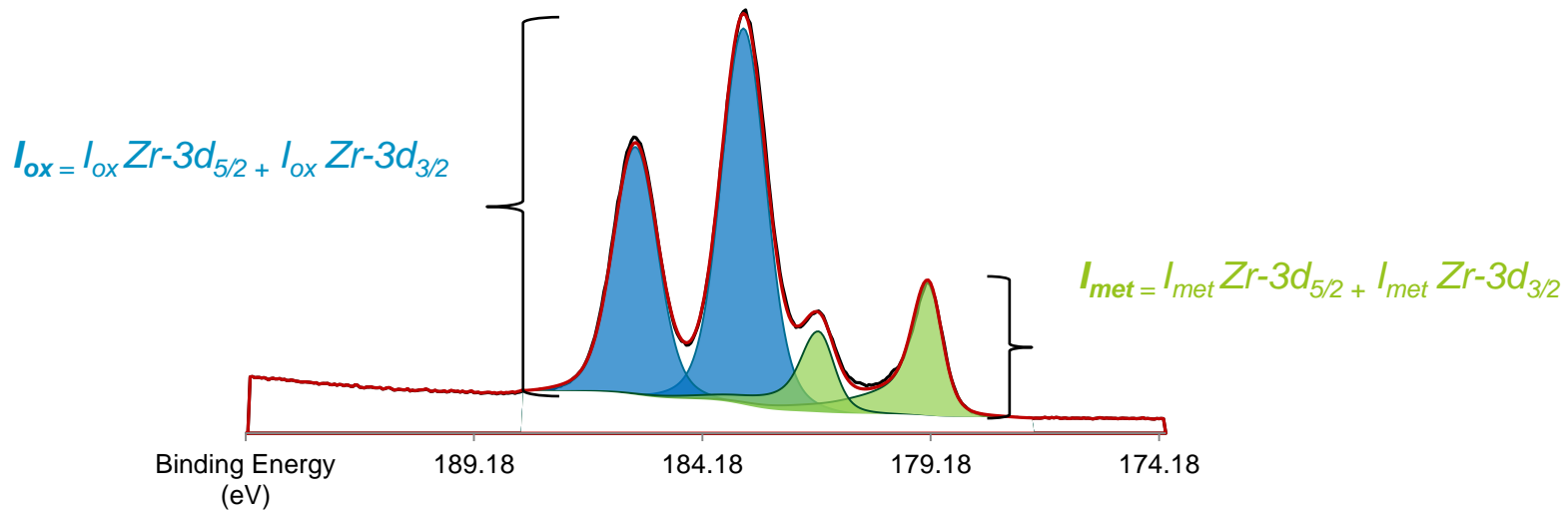

XPS: Parameters estimation

I_{ox} and I_{met} : Estimated by recomposing the spectra of Zr 3d levels

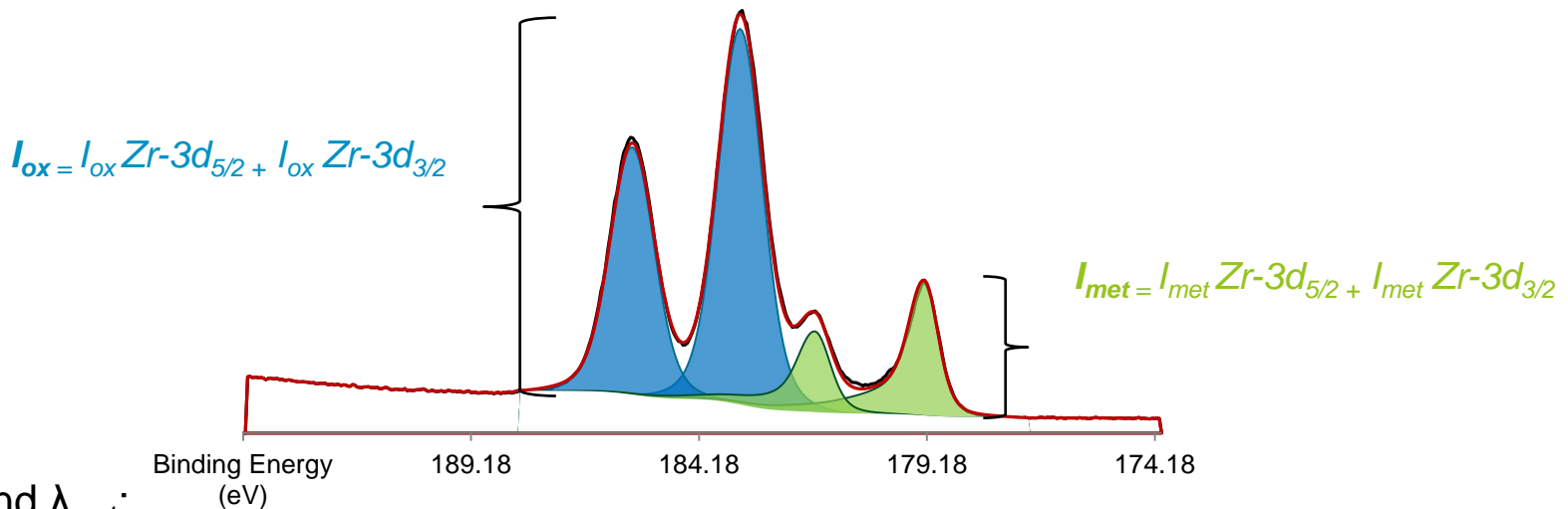

λ_{ox} and λ_{met} :

- Seah & Dench [1] (empirical)
- Tanuma, Powell et Penn (TPP-2M) [2] (*ab initio* calculus)
- Gries (G-1) [3] (*ab initio* calculus)

	λ_{met} (nm)	λ_{ox} (nm)
SD	2,3	4,9
TPP-2M	2,6*	2,3*
G-1	3,1*	2,4*

For Zirconium

[1] M.P. Seah and Dench Surf. Interface Anal. 1 (1979) 2
 [2] S. Tanuma, C.J. Powell, D.R. Penn, Surf. Interface Anal. 21 (1994) 165.
 [3] W.H Gries, Surf. Interface Anal. 24 (1996) 38
 * Selon NIST Standard Reference Database 71

EIS

- Complex capacitance representation

$$C(\omega) = \frac{1}{j \cdot \omega (Z(\omega) - R_e)}$$

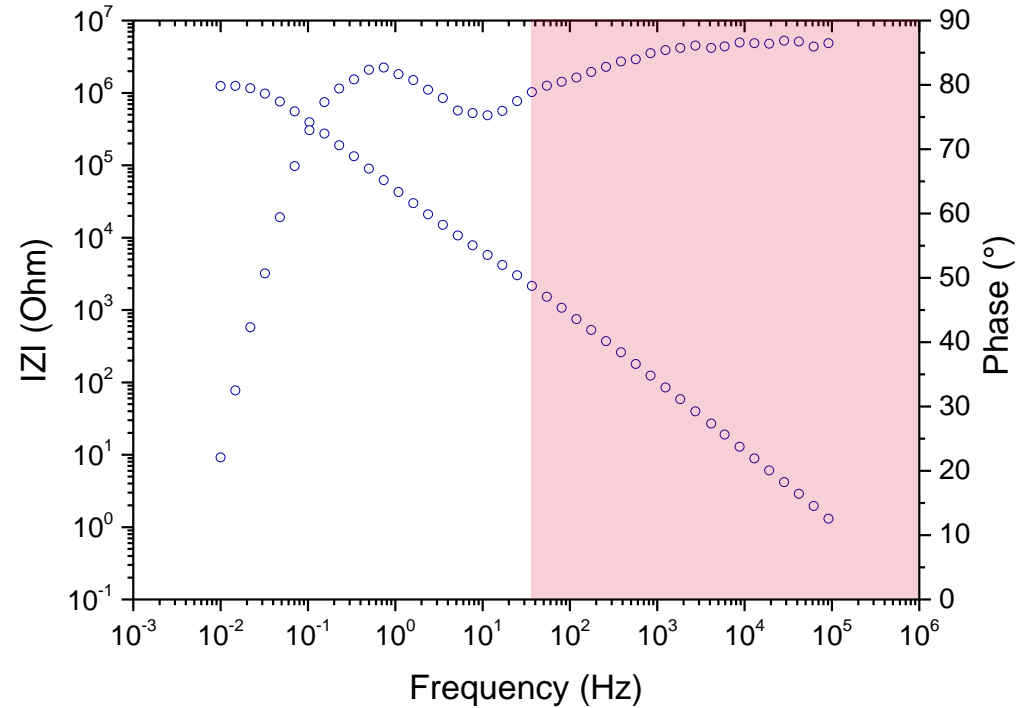

EIS

Complex capacitance representation

$$C(\omega) = \frac{1}{j \cdot \omega (Z(\omega) - R_e)}$$

Dielectric material behavior: Jonscher's Law^[1]

$$C(\omega) = C_\infty + \Delta C \cdot (j\omega)^{\alpha-1}$$

Avec $0 < \alpha < 1$

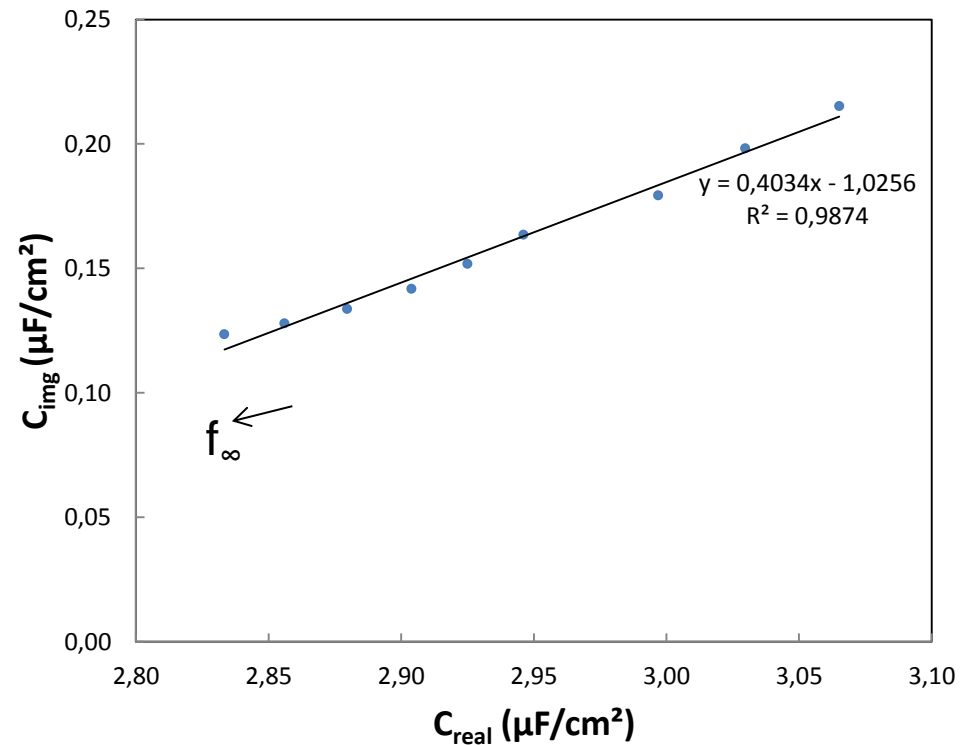

[1]Jonscher, A.K., A many-body universal approach to dielectric relaxation in solids. Physics of Dielectric Solids, 1980.

EIS

Complex capacitance representation

$$C(\omega) = \frac{1}{j \cdot \omega(Z(\omega) - R_e)}$$

Dielectric material behavior: Jonscher's Law^[1]

$$C(\omega) = C_\infty + \Delta C \cdot (j\omega)^{\alpha-1}$$

Avec $0 < \alpha < 1$

With C_∞ : film thickness calculation:

$$d = \frac{\epsilon \epsilon_0}{C_\infty}$$

With: ϵ : dielectric constant of the material (22)

ϵ_0 : dielectric permittivity of vacuum ($8.85 \cdot 10^{-14}$ F/cm)

C_∞ : Infinite capacitance corresponding to the defectless oxide layer

(here, $2,56 \mu\text{F}/\text{cm}^2$)

Another method to calculate the thickness, Power law's model ^[2] giving a similar result.

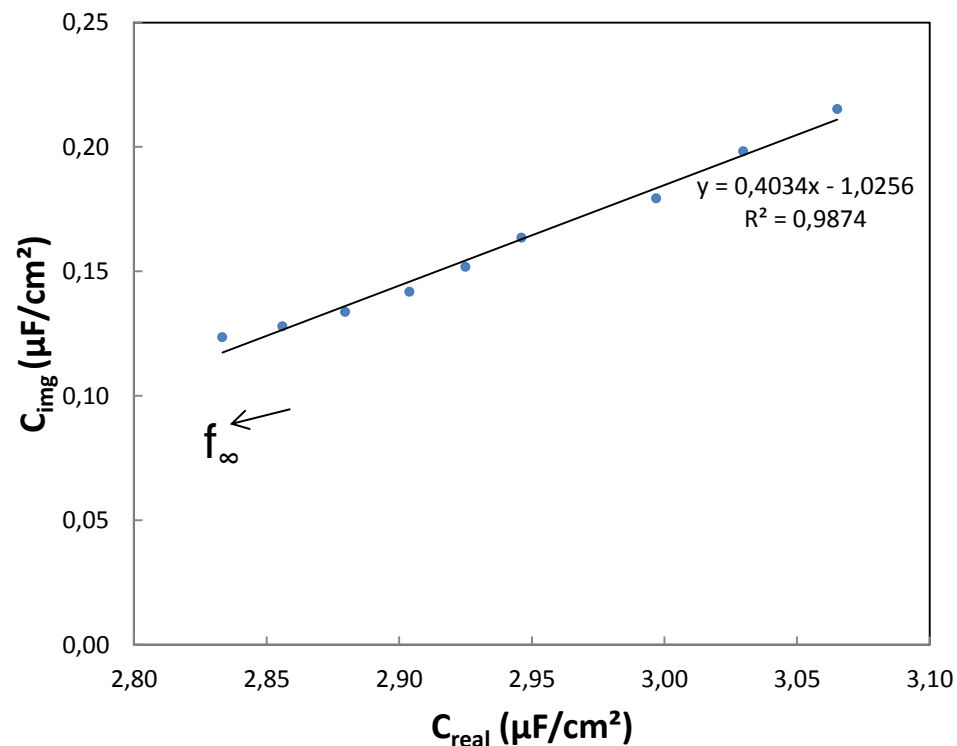

[1] Jonscher, A.K., A many-body universal approach to dielectric relaxation in solids. Physics of Dielectric Solids, 1980.

[2] B. Hirschorn, M. E. Orazem, B. Tribollet, V. Vivier, I. Frateur, and M. Musiani, *J. Electrochem. Soc.*, **157**, C458 2010.

■ Comparison of two techniques (XPS and EIS) for 4 samples

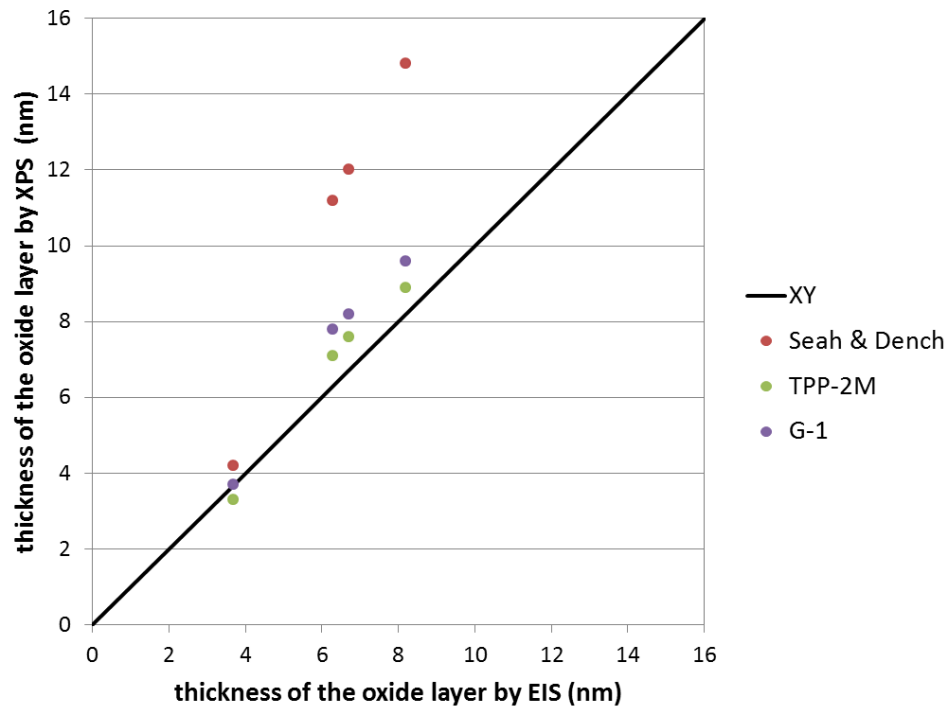

■ Discussion:

- consistent results
- TPP-2M method values seem closer to the EIS ones

Objective: to study the role of the passive layer (ZrO_2) on the kinetics of reduction of Fe(III)/Fe(II) couple

■ Formation & characterization of passive layer with a controlled thickness

- Formation of passive layer
- Monitoring the (nanometric scaled) thickness
 - *Ex situ* method: XPS
 - *In situ* method: EIS
- Results

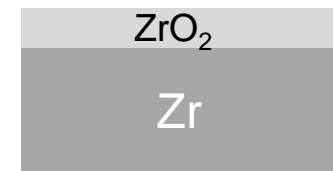

■ Study of Fe(III) reduction kinetics by EIS on a nanometric passive film

- EIS analysis
- Results

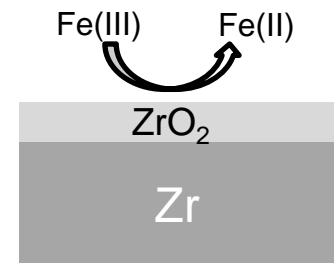

■ Conclusion and outlook



Evolution of impedance spectra with potential

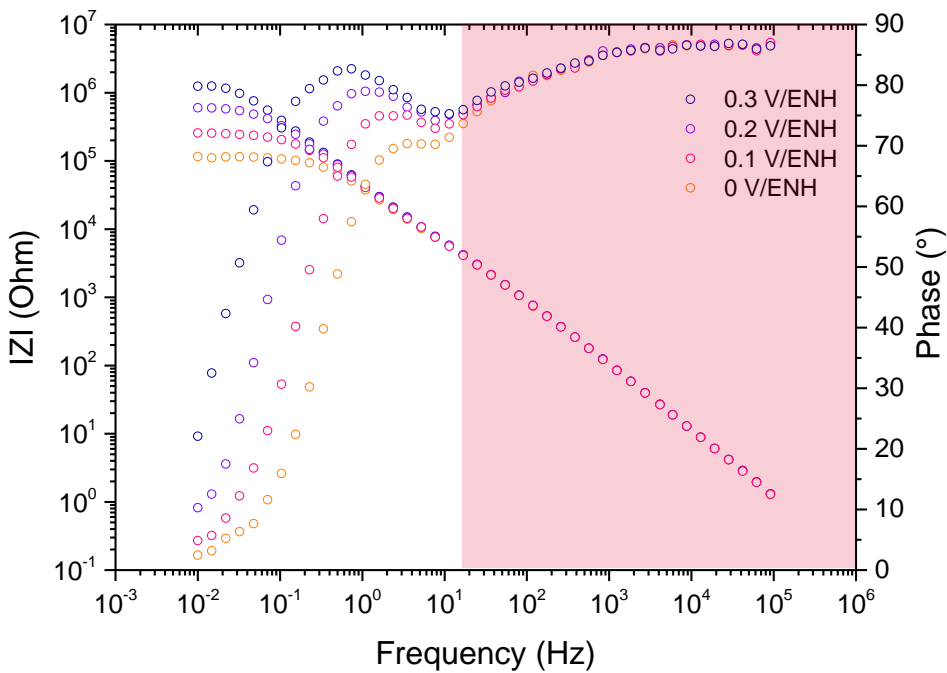

Bode Plot

ZrM106 (8.2 nm)
H₂SO₄ 0.5 M FeII/FeIII 0.1M
Room temperature



Evolution of impedance spectra with potential

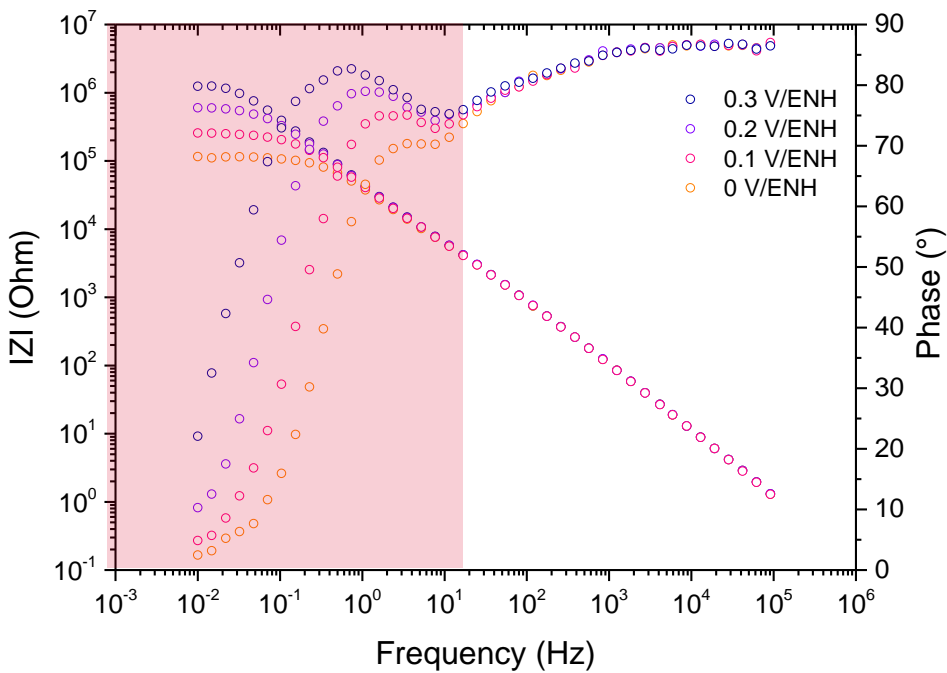

Bode Plot

ZrM106 (8.2 nm)
H₂SO₄ 0.5 M FeII/FeIII 0.1M
Room temperature



Evolution of impedance spectra with potential

Proposed equivalent circuit:

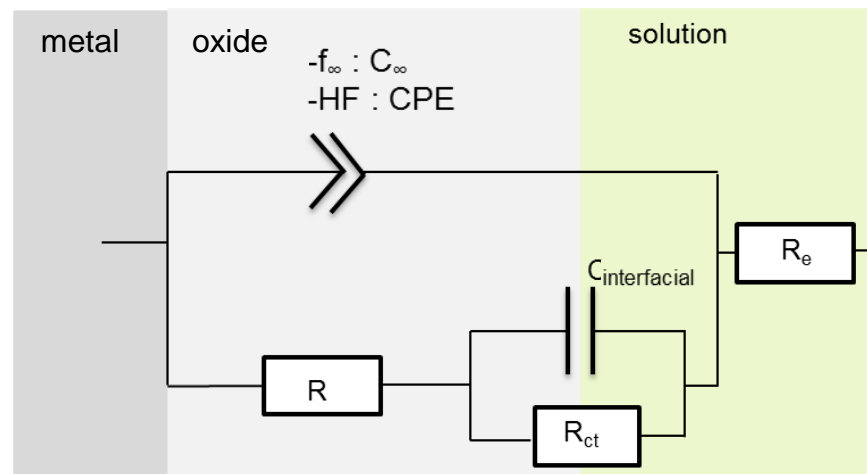

With:

- R_e : Electrolyte resistance
- C_∞ (at f_∞) & CPE: defectless capacitance representing film and the dielectric losses in the film
- $C_{interfacial}$: Space charge capacitance and double layer capacitance
- R_{ct} : charge transfer resistance
- R : its physical meaning is open to interpretation.

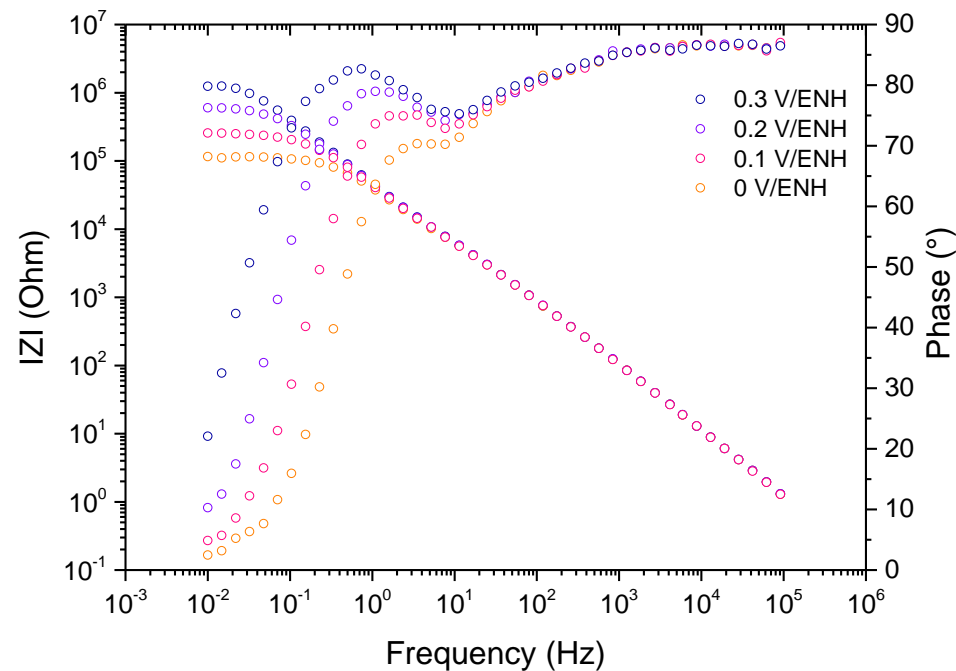

Bode Plot

ZrM106 (8.2 nm)
H₂SO₄ 0.5 M FeII/FeIII 0.1M
Room temperature

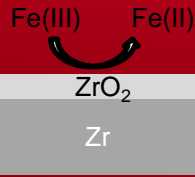

Justification of the equivalent circuit

As before the high frequency part is attributed to the dielectric properties of the film (Jonscher's Law)

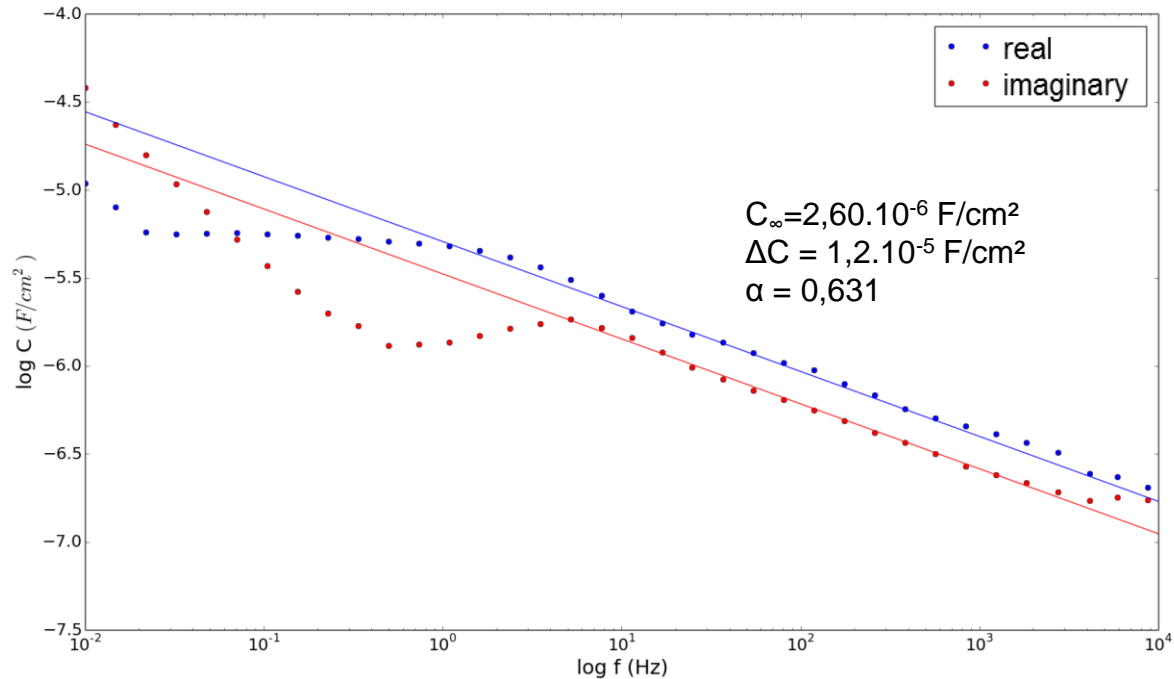
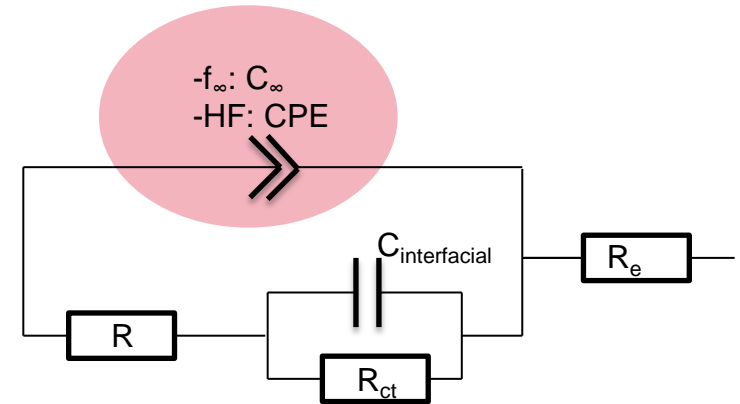

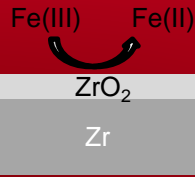

Justification of the equivalent circuit

■ As before the high frequency part is attributed to the dielectric properties of the film (Jonscher's Law)

■ Low frequency part: R_{ct} & $C_{interfacial}$

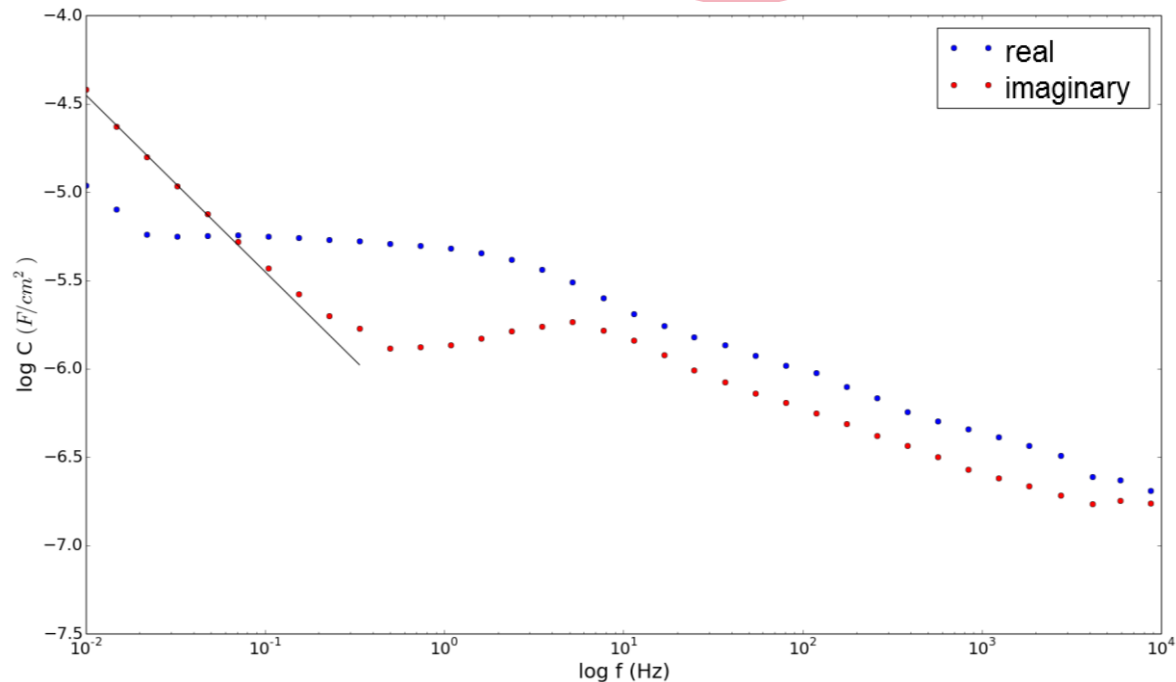
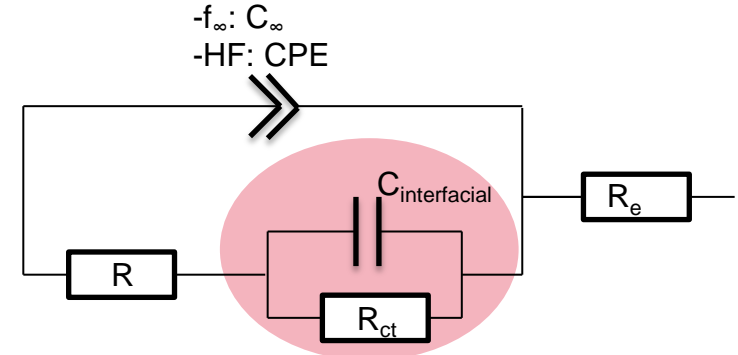

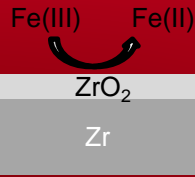

Justification of the equivalent circuit

As before the high frequency part is attributed to the dielectric properties of the film (Jonscher's Law)

Low frequency part: R_{ct} & $C_{interfacial}$

Intermediate frequency part: R

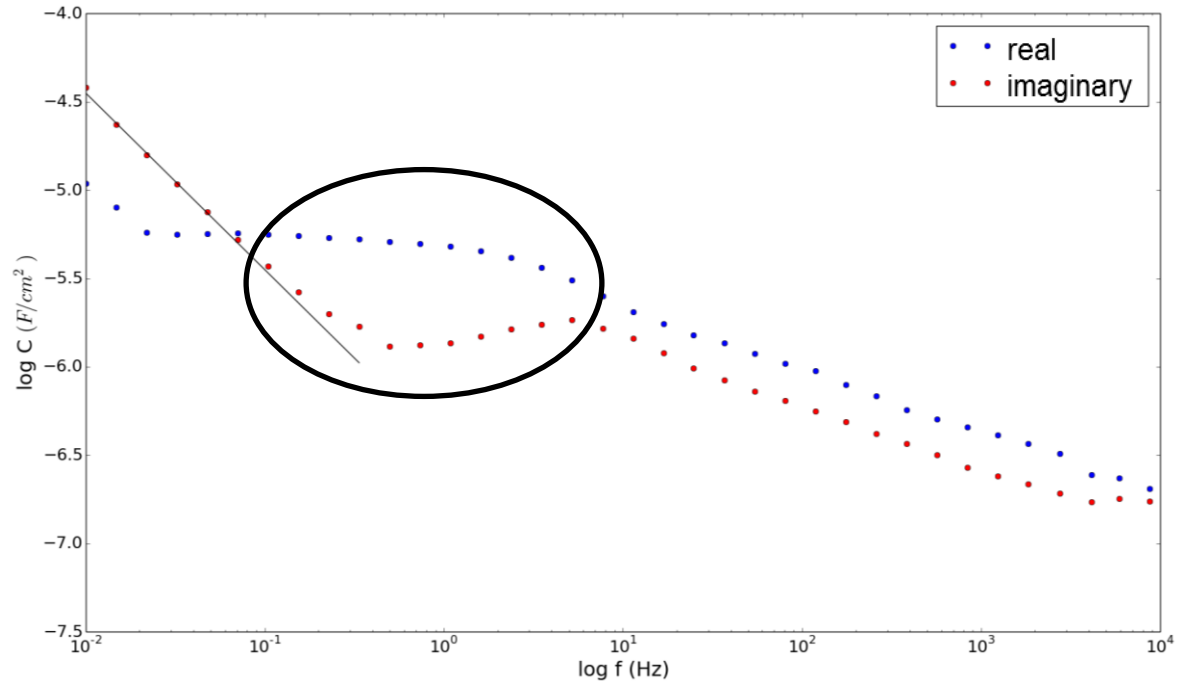
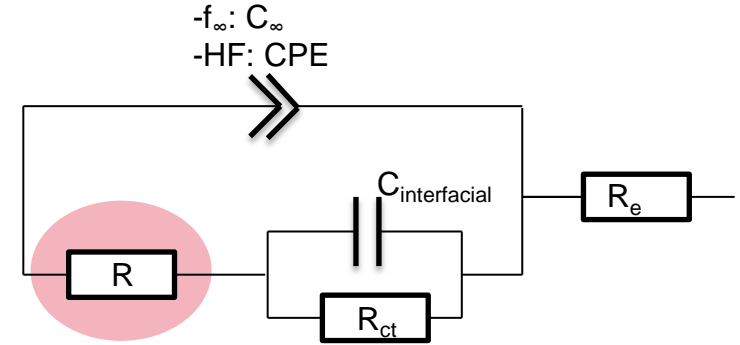

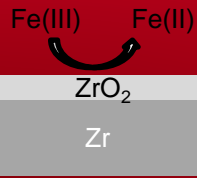

Semiconducting properties of the film

-f_∞: C_∞
-HF: CPE

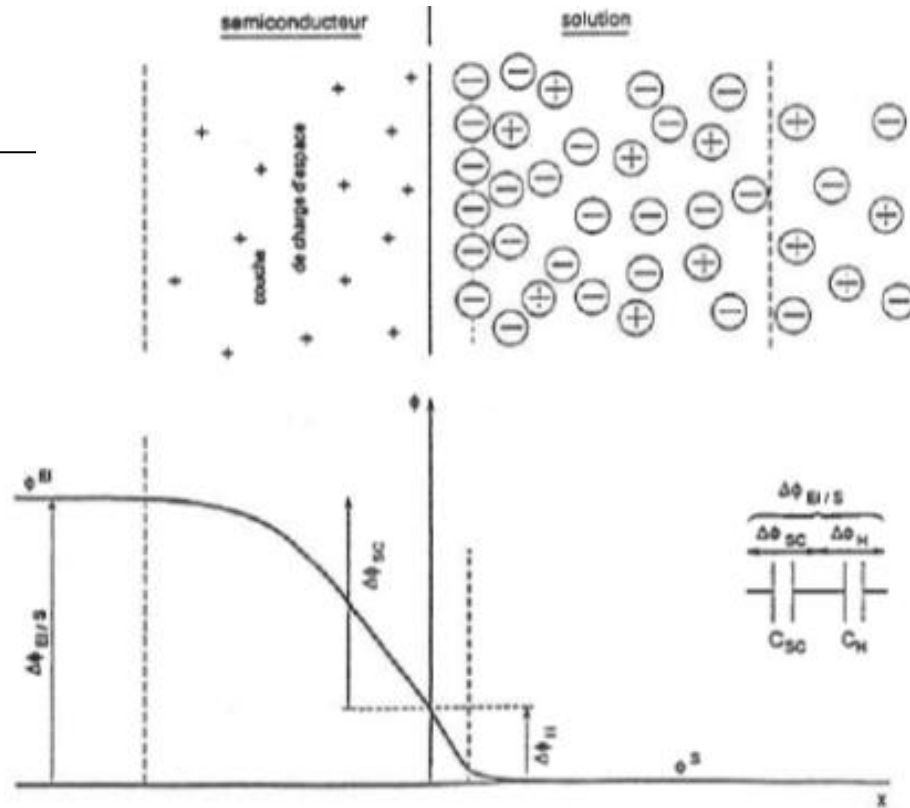
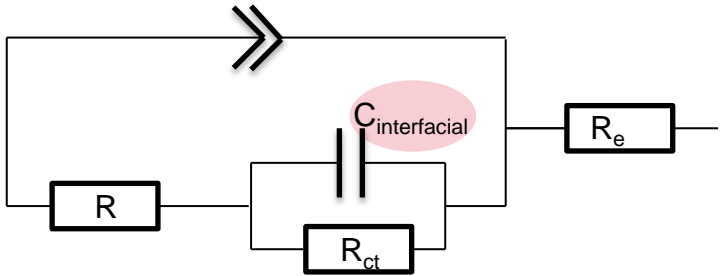

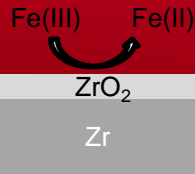

Semiconducting properties of the film

-f_∞: C_∞
-HF: CPE

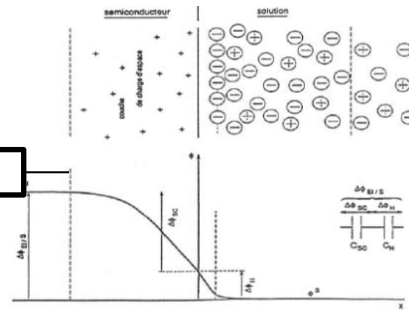
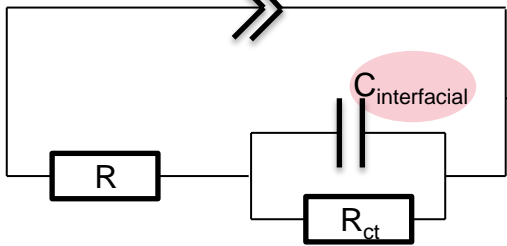

■ Verification of the Mott-Schottky's law:

$$\frac{1}{C_{SC}^2} = \frac{2}{\epsilon \epsilon_0 q_e N_0} \left(E - E_{bp} - \frac{k_B T}{q_e} \right)$$

- With: ϵ : dielectric constant of the material
- ϵ_0 : dielectric permittivity of vacuum: $8,85 \cdot 10^{-14}$ F/cm²
- q_e : elementary charge of the electron
- N_0 : charge carriers number
- k_B : Boltzmann's constant
- E_{BP} : flat band potential

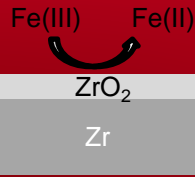

Semiconducting properties of the film

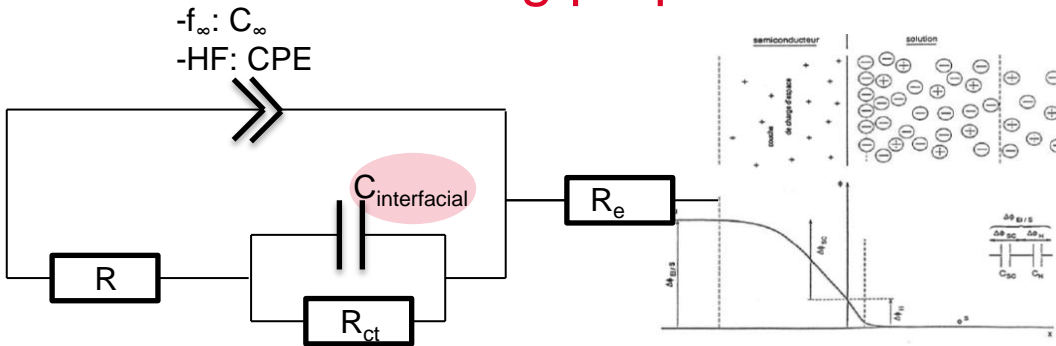

■ Verification of the Mott-Schottky's law:

$$\frac{1}{C_{SC}^2} = \frac{2}{\epsilon \epsilon_0 q_e N_0} \left(E - E_{bp} - \frac{k_B T}{q_e} \right)$$

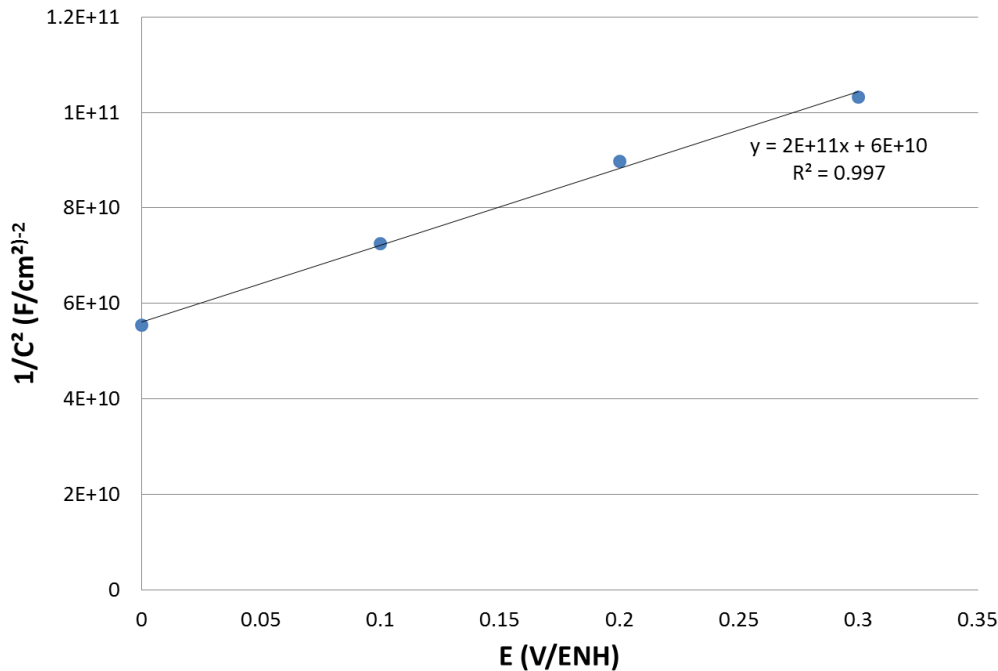

With: ϵ : dielectric constant of the material
 ϵ_0 : dielectric permittivity of vacuum: $8,85 \cdot 10^{-14}$ F/cm²
 q_e : elementary charge of the electron
 N_0 : charge carriers number
 k_B : Boltzmann's constant
 E_{BP} : flat band potential

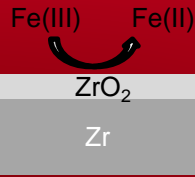

Semiconducting properties of the film

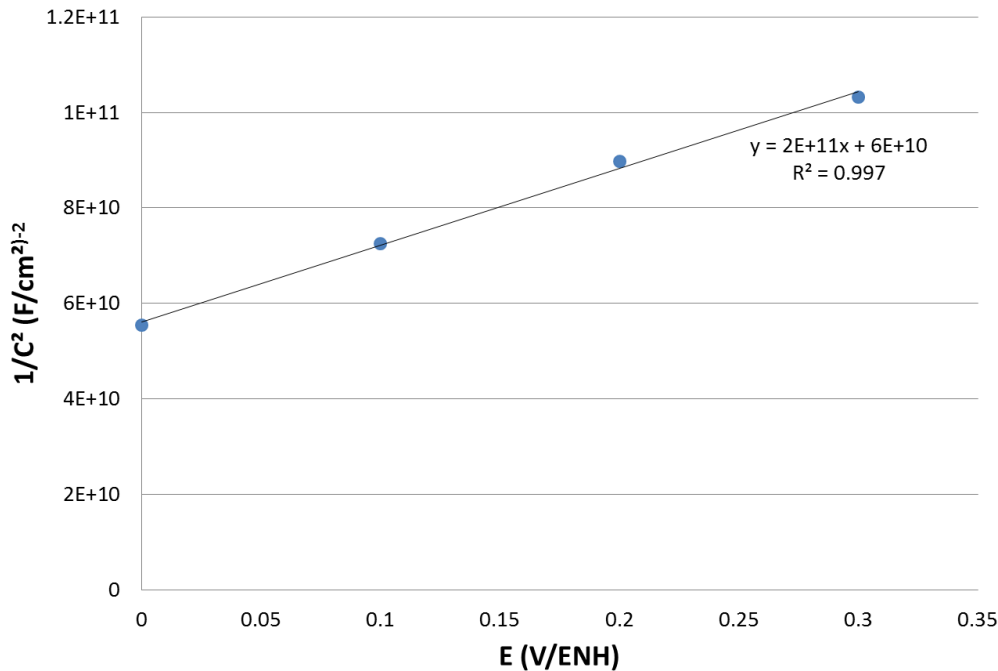
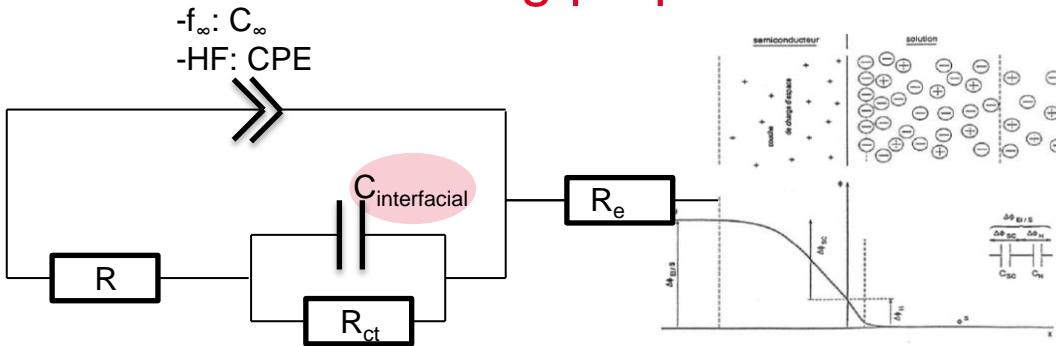

■ Verification of the Mott-Schottky's law:

$$\frac{1}{C_{SC}^2} = \frac{2}{\epsilon \epsilon_0 q_e N_0} \left(E - E_{bp} - \frac{k_B T}{q_e} \right)$$

With: ϵ : dielectric constant of the material
 ϵ_0 : dielectric permittivity of vacuum: $8,85 \cdot 10^{-14}$ F/cm²
 q_e : elementary charge of the electron
 N_0 : charge carriers number
 k_B : Boltzmann's constant
 E_{BP} : flat band potential

■ Results:

- Positive slope: ZrO₂ n-type semiconductor
- Determination of the charge number carriers N_0



Semiconducting properties of the film

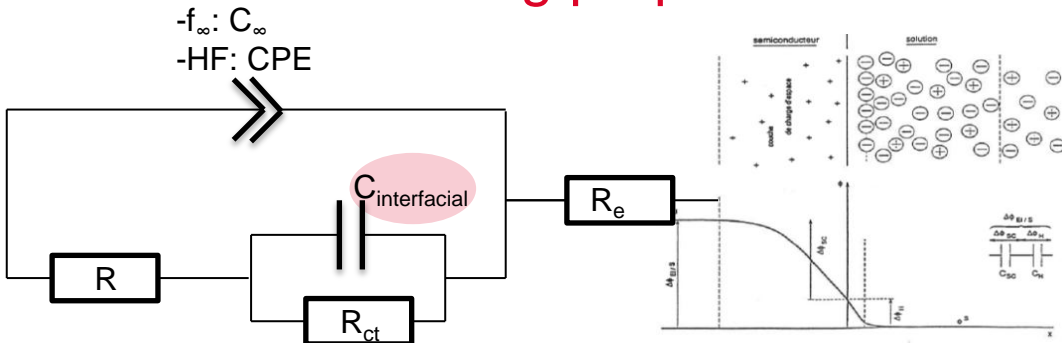

■ Verification of the Mott-Schottky's law:

$$\frac{1}{C_{SC}^2} = \frac{2}{\epsilon \epsilon_0 q_e N_0} \left(E - E_{bp} - \frac{k_B T}{q_e} \right)$$

With: ϵ : dielectric constant of the material
 ϵ_0 : dielectric permittivity of vacuum: $8,85 \cdot 10^{-14}$ F/cm²
 q_e : elementary charge of the electron
 N_0 : charge carriers number
 k_B : Boltzmann's constant
 E_{BP} : flat band potential

■ Results:

- Positive slope: ZrO₂ n-type semiconductor
- Determination of the charge number carriers N_0

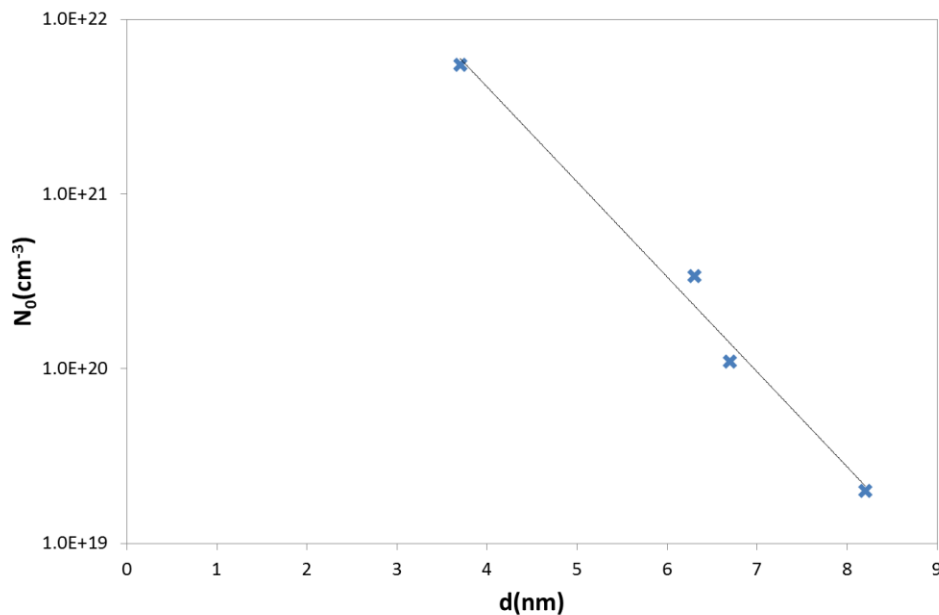

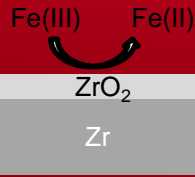

Evolution of the constant rate k_c according to thickness

-f_∞: C_∞
-HF: CPE

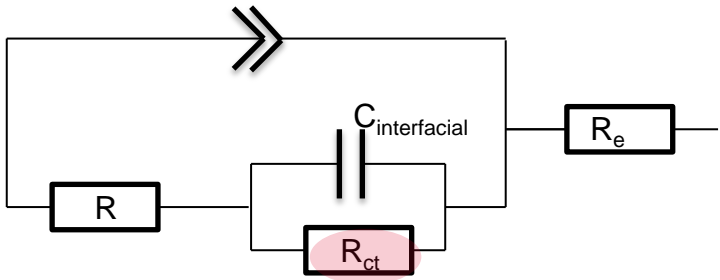

$$R_{ct} = \frac{RT}{\alpha n^2 F^2 S \left(k_c \overline{C_{ox}}(0) e^{\frac{-\alpha n F}{RT}(E-E^0)} \right)}$$

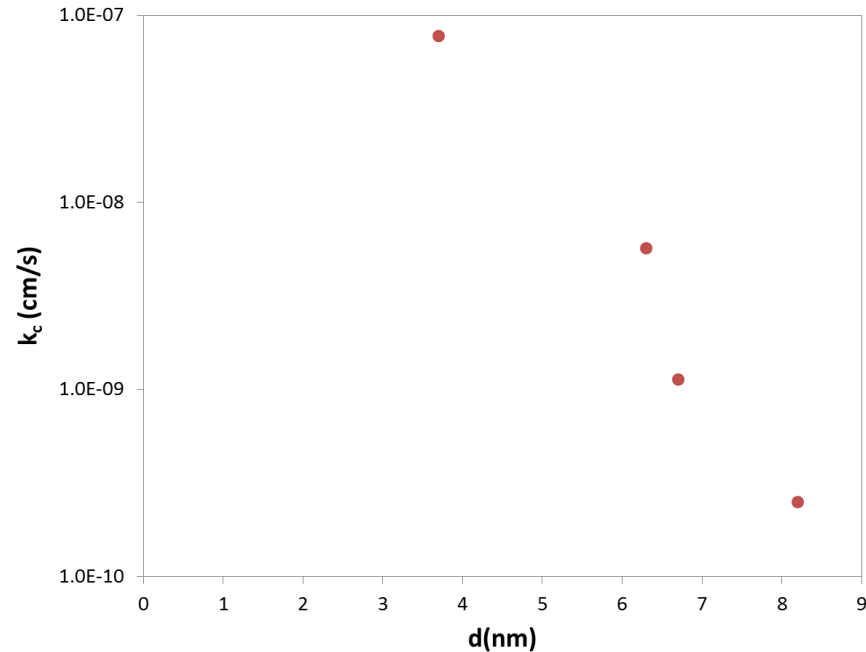

- k_c (determined from R_{ct}) decreases as the thickness increases

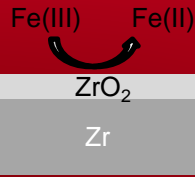

Evolution of the constant rate k_c according to thickness

-f_∞: C_∞
-HF: CPE

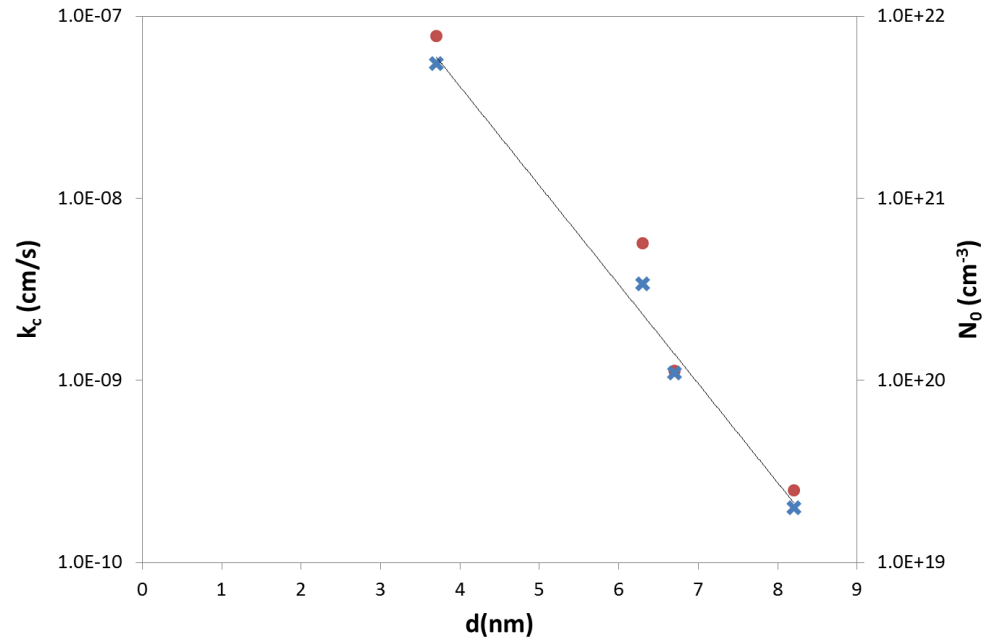
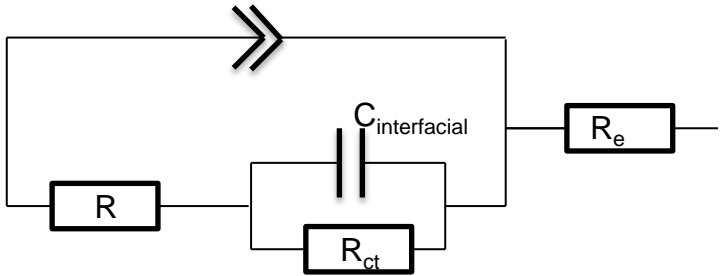

- k_c (determined from R_{ct}) decreases as the thickness increases
- k_c follows the same trend as N_0

The evolution of k_c is linked to the semiconducting properties of ZrO₂

Conclusions

- Formation of ZrO_2 layers:
 - Formation of 4 layers of different thicknesses
 - Comparison of 2 experimental techniques for the thickness measurement

Conclusions

- Formation of ZrO_2 layers:
 - Formation of 4 layers of different thicknesses
 - Comparison of 2 experimental techniques for the thickness measurement

- Kinetics of Fe(III) reduction
 - Advanced understanding of EIS spectra
 - Properties of ZrO_2 layer: C_∞ (d), C_{sc} (N_0)
 - Kinetics of Fe(III) reduction: R_{ct} (k_c)
 - Constant k_c :
 - decreases with d
 - Linked to N_0

Conclusions

- Formation of ZrO_2 layers:
 - Formation of 4 layers of different thicknesses
 - Comparison of 2 experimental techniques for the thickness measurement

- Kinetics of Fe(III) reduction
 - Advanced understanding of EIS spectra
 - Properties of ZrO_2 layer: C_∞ (d), C_{sc} (N_0)
 - Kinetics of Fe(III) reduction: R_{ct} (k_c)
 - Constant k_c :
 - decreases with d
 - Linked to N_0

Outlook

- Extension of the approach to other systems
 - Stainless steel
 - $\text{HNO}_3/\text{HNO}_2$



Reprocessing plant of La Hague



Acknowledgments:



M. Bigot, N. Brijou-Mokrani, N. Cavaliere, C-A. Decoupigny, A. Fallet, P. Fauvet, O. Geneve, N. Gruet, S. Heurtault, P. Laghoutaris, B. Laurent, F. Martin, S. Pasquier-Tilliette, B. Puga, M. Rivollier, R. Robin, V. Soulié.

ELABORATION D'UN FILM PASSIF CONTRÔLÉ - DÉTERMINATION ÉPAISSEUR

Comparaison des valeurs d'épaisseur du film passif: XPS/EIS

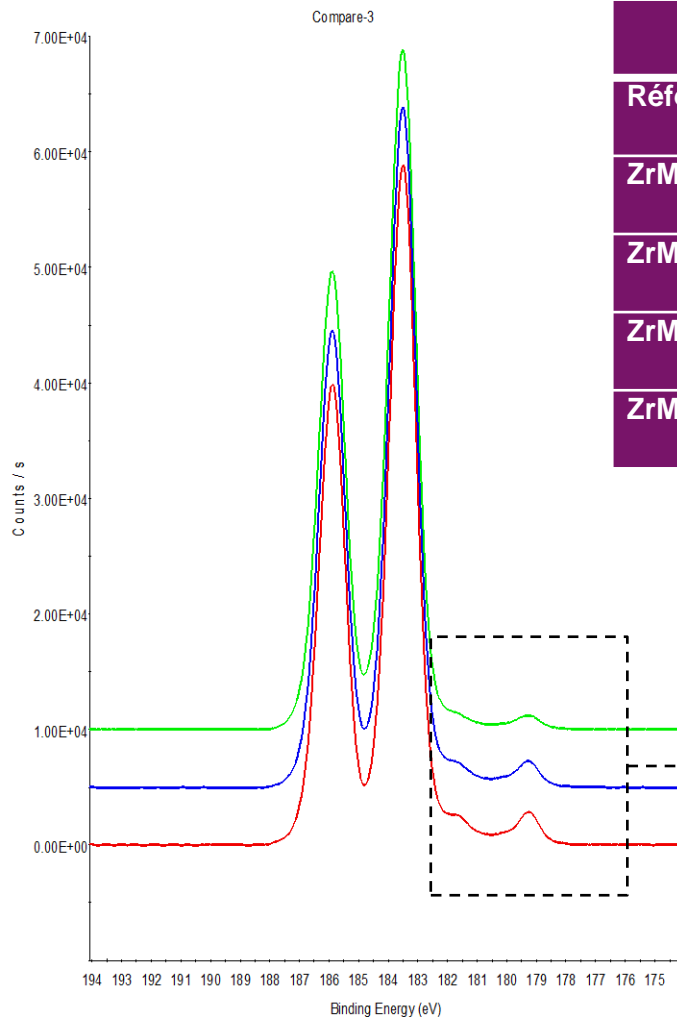

	EIS	XPS		
Référence	d_{\min} (EIS) (nm)	d_{SD} (nm)	d_{TPP-2M} (nm)	d_{G-1} (nm)
ZrM103	5,6	11,2	7,1	7,8
ZrM104	/	4,2	3,3	3,7
ZrM105	6,3	12,0	7,6	8,2
ZrM106	7,7	14,8	8,9	9,6

ZrM106
ZrM105
ZrM103

→ Comparaison des spectres Zr-3d normalisés sur le niveau $Zr_{ox}-3d_{5/2}$

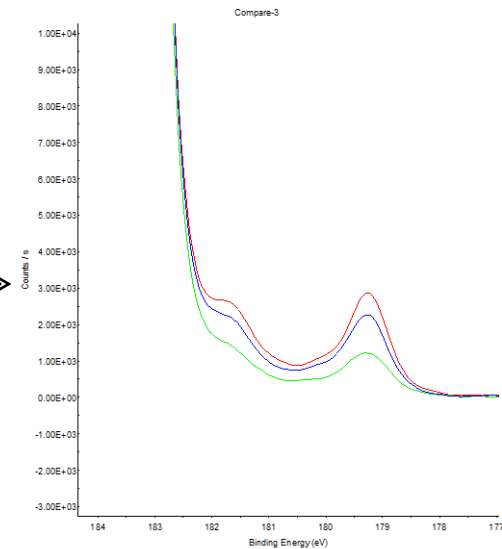

CROISSANCE DU FILM PASSIF

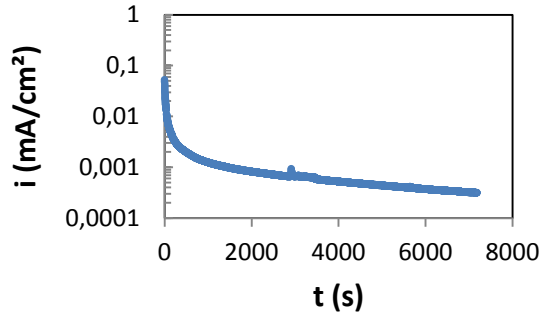

Caractéristiques du film passif:

- de faible épaisseur
- stable
- non poreuse

■ Boucle capacitive:
processus se déroulant en parallèle

■ Représentation de Nyquist pas adaptée

■ Représentation de type capacité complexe adaptée à ce type de processus

$$C(\omega) = \frac{1}{j \cdot \omega(Z(\omega) - R_e)}$$

Suivi EIS de la croissance du film

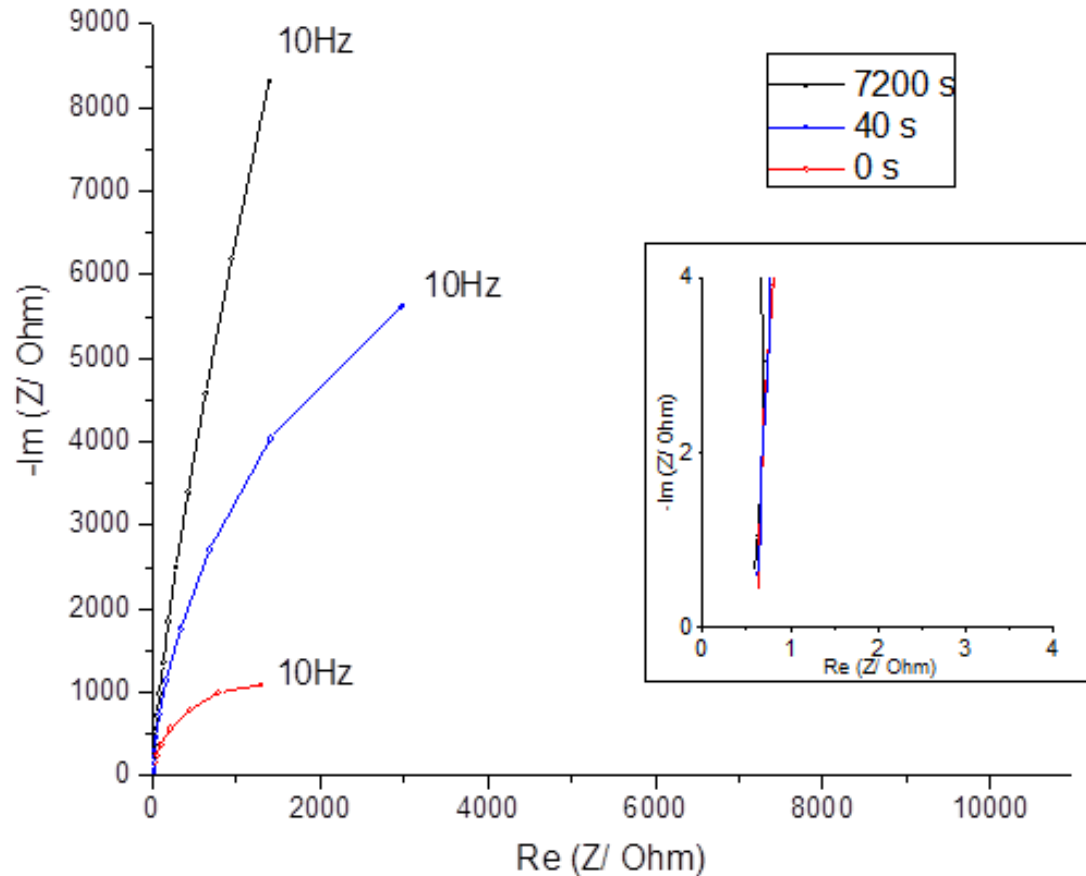

Représentation de Nyquist