



**HAL**  
open science

## Dynamic analysis of a multi-contact problem with clearances, application to the SFR fuel pins bundle.

Catterou Thomas, Bruno Cochelin, Stéphane Bourgeois, V. Blanc, Guillaume Ricciardi

► **To cite this version:**

Catterou Thomas, Bruno Cochelin, Stéphane Bourgeois, V. Blanc, Guillaume Ricciardi. Dynamic analysis of a multi-contact problem with clearances, application to the SFR fuel pins bundle.. EU-RODYN 2017 - 10th international conference on structural dynamics, Sep 2017, Rome, Italy. cea-02508894

**HAL Id: cea-02508894**

**<https://cea.hal.science/cea-02508894>**

Submitted on 16 Mar 2020

**HAL** is a multi-disciplinary open access archive for the deposit and dissemination of scientific research documents, whether they are published or not. The documents may come from teaching and research institutions in France or abroad, or from public or private research centers.

L'archive ouverte pluridisciplinaire **HAL**, est destinée au dépôt et à la diffusion de documents scientifiques de niveau recherche, publiés ou non, émanant des établissements d'enseignement et de recherche français ou étrangers, des laboratoires publics ou privés.

# Dynamic analysis of a multi-contact problem with clearances, application to the SFR fuel pins bundle.

CATTEROU Thomas, PhD student.

thomas.catterou@cea.fr

Bruno Cochelin, Stephane Bourgeois – *LMA Marseille, France*

Victor Blanc, Guillaume Ricciardi – *CEA Cadarache, France*

September, 11<sup>th</sup> 2017

EURODYN2017 – X<sup>th</sup> international conference on structural dynamics

# Introduction

## ■ Goal

- Characterize the non-linear dynamical behavior of the ASTRID pins bundle with mounting gaps for different loads (handling, transport, earthquake).
- Ensure the integrity of the first containment barrier.

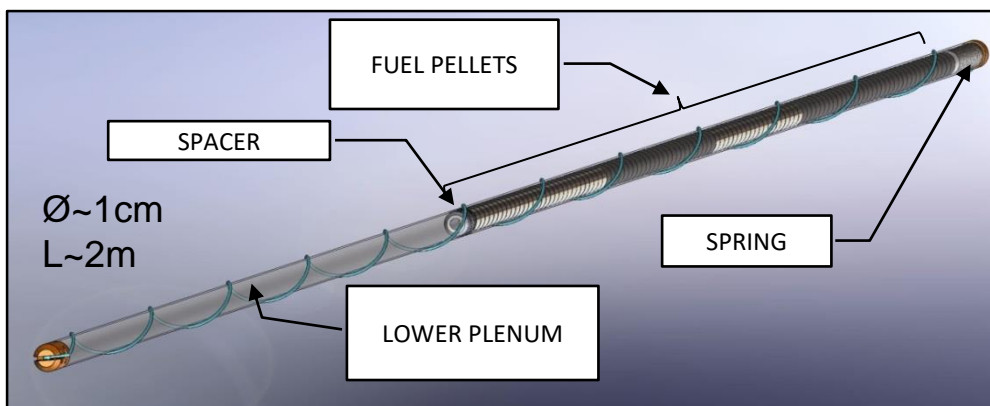

*A fuel pin*

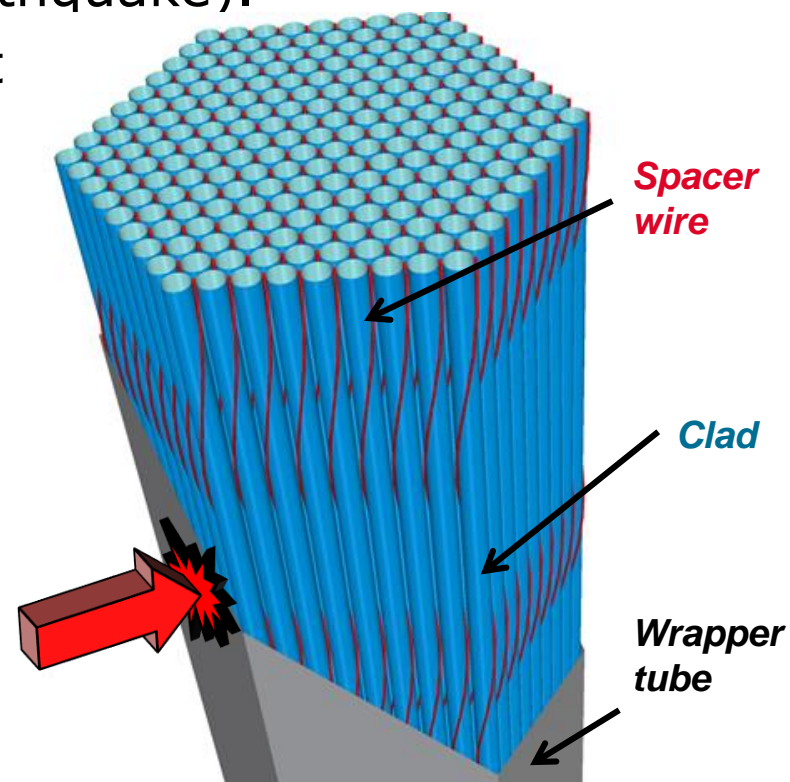

*A fuel sub assembly*

# Introduction

- A large number of pins (217) and localized contact zone (~15000)

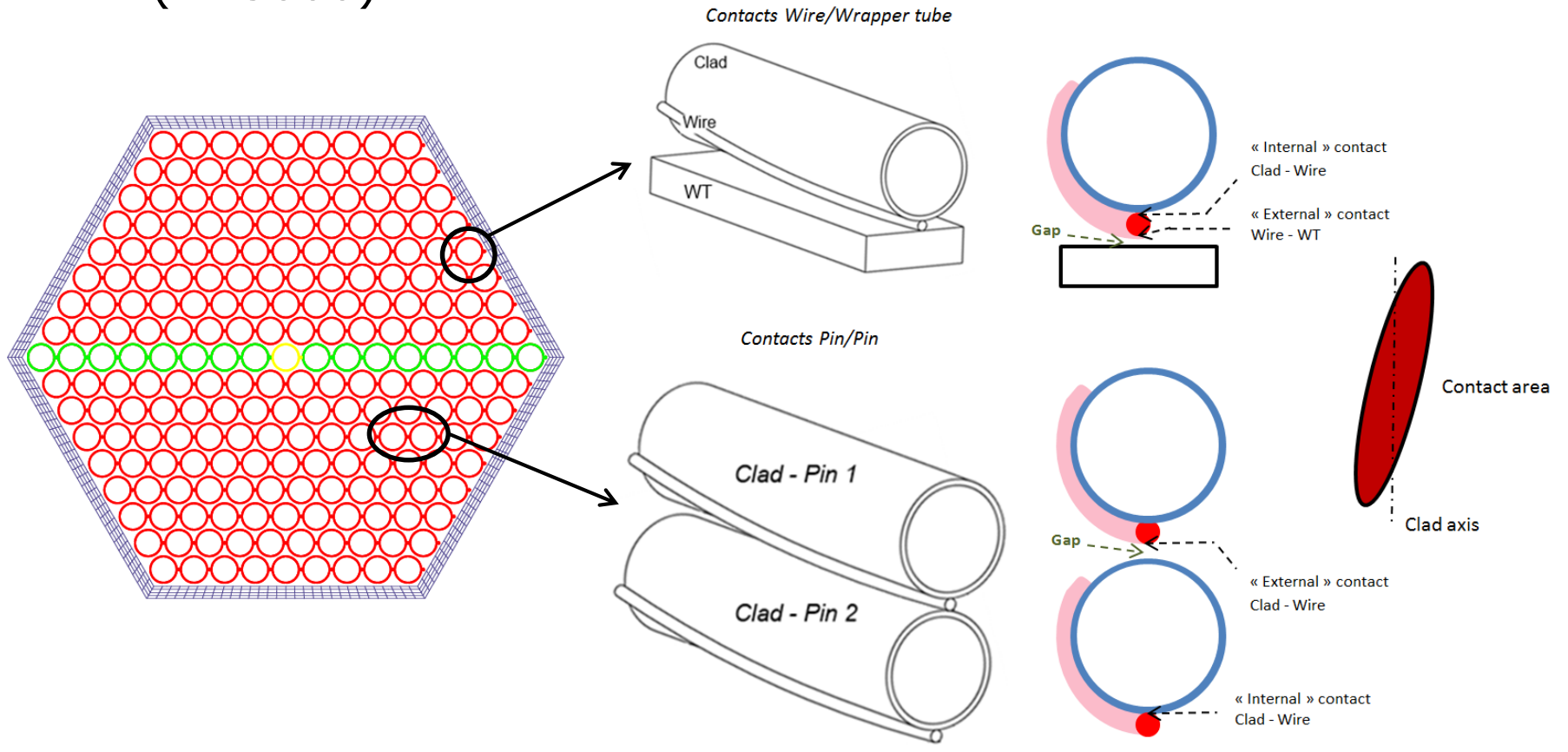

# Introduction

## — Hypothesis:

- Timoshenko beams
- Small deformations

## — Methodology of numerical method validation

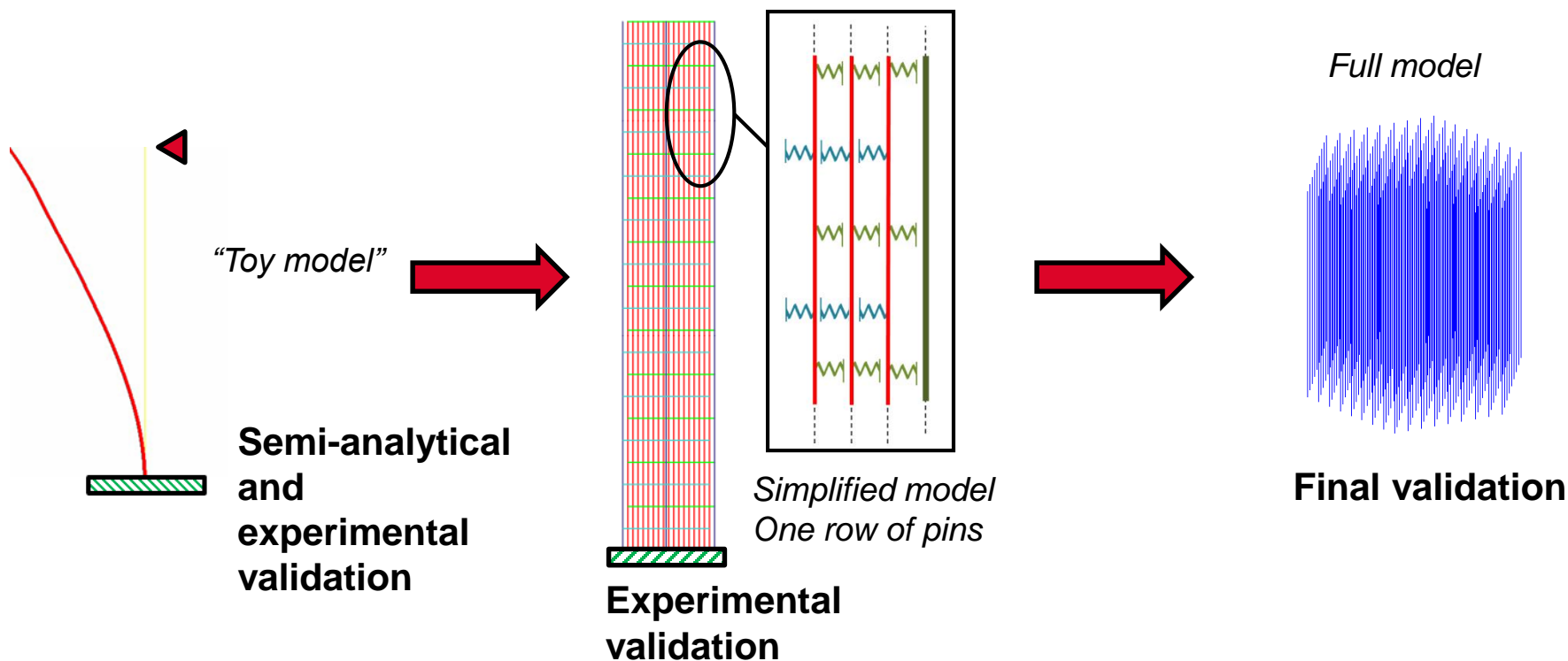

# Clamped beam colliding on a spring

## ■ Numerical method (Cast3M finite element software)



- Explicit integration scheme (central difference method)
- Modal analysis without contacts
- Resolution of the fundamental equation of the dynamic on the modal base

$$\Phi^t M \Phi \ddot{q} + \Phi^t C \Phi \dot{q} + \Phi^t K \Phi q = \Phi^t F_{ext} + \Phi^t F_{shock}(u, \dot{u}).$$

- Modal recombination for each time step on contact points to estimate contact forces  $F_{shock}$
- Sub-structuring for the full model

# Clamped beam colliding on a spring

## ■ Semi-analytical method

### ■ Modal basis analysis of two basic problems



### ■ Resolution of the fundamental equation of the dynamic on the modal base

$$\ddot{q}_i + 2\xi_i\omega_i\dot{q}_i + \omega_i^2 q = 0$$

$$q_i(t) = e^{-\xi_i\omega_i t} (A_i \cos(\omega_d t) + B_i \sin(\omega_d t))$$

$$A_i = \frac{\int_{\Omega} u_0 \cdot \Phi_i}{\int_{\Omega} \Phi_i \cdot \Phi_i}; \quad B_i = \frac{\int_{\Omega} v_0 \cdot \Phi_i}{\omega_i \int_{\Omega} (\Phi_i \cdot \Phi_i)} + \frac{\xi_i}{\omega_i \sqrt{1 - \xi_i^2}} A_i \quad ; \quad \omega_d = \omega_i (1 - \xi_i^2).$$

$$u_f(x, t) = \sum X_{fi}(x) q_{fi}(t) \quad \longleftrightarrow \quad u_s(x, t) = \sum X_{si}(x) q_{si}(t)$$

Switching time ?

# Clamped beam colliding on a spring

## ■ Semi-analytical method

- Root finding algorithm to find the switching time

$$t_{n+1} = t_n - \frac{f(t_n)(t_n - t_{n-1})}{f(t_n) - f(t_{n-1})} \quad (\text{Secant method})$$

- Creation of the solution

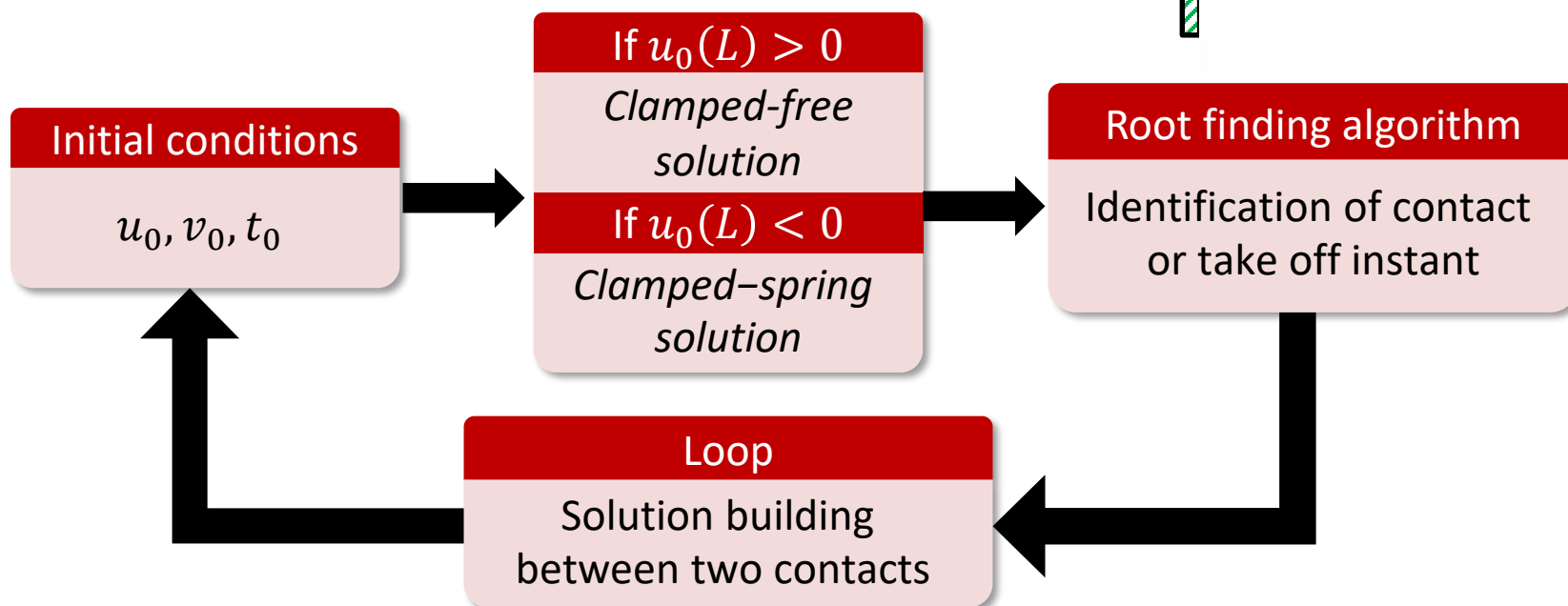
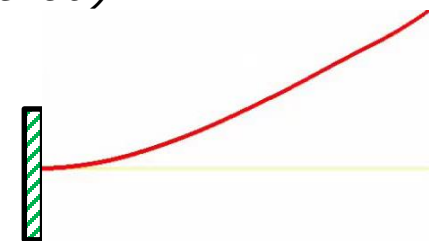



# Clamped beam colliding on a spring

## Results : displacements

$$R_{ftrunc} = 10 / R_k = 3000$$

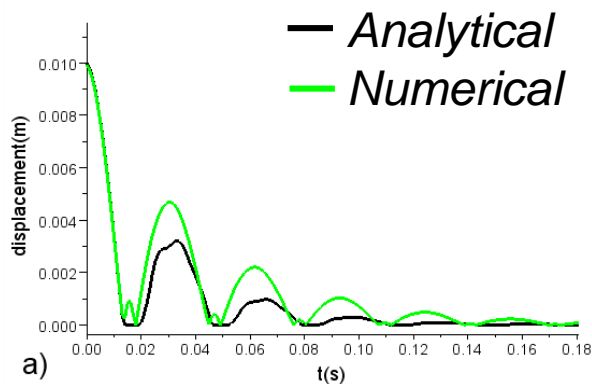

$$R_{ftrunc} = 300 / R_k = 3000$$

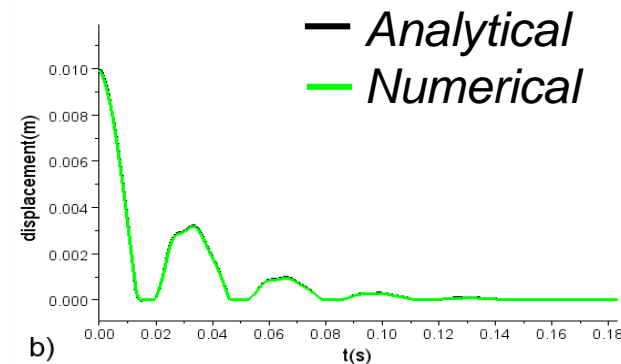

$$R_{ftrunc} = 300 / R_k = 5$$

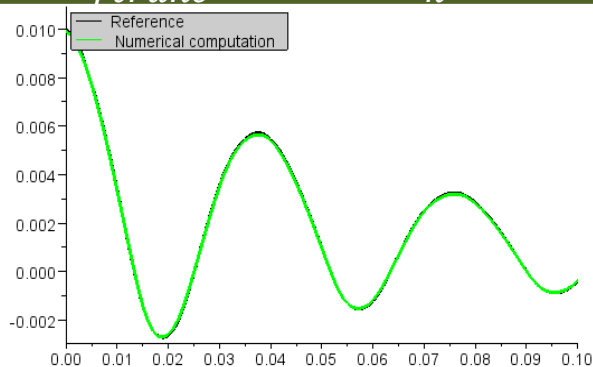

$$R_k = \frac{K_{spring}}{K_{bending}},$$

Hardness of the contact

$$R_{ftrunc} = \frac{f_{trunc}}{f_1}$$

# Clamped beam colliding on a spring

## Validation – Frequency truncation

$$R_{ftrunc} = \frac{f_{trunc}}{f_1}$$

reference = semi-analytic method

$$\text{Err} = \frac{\max(|\Gamma_{num} - \Gamma_{ref}|)}{\max(|\Gamma_{num}|, |\Gamma_{ref}|)}$$

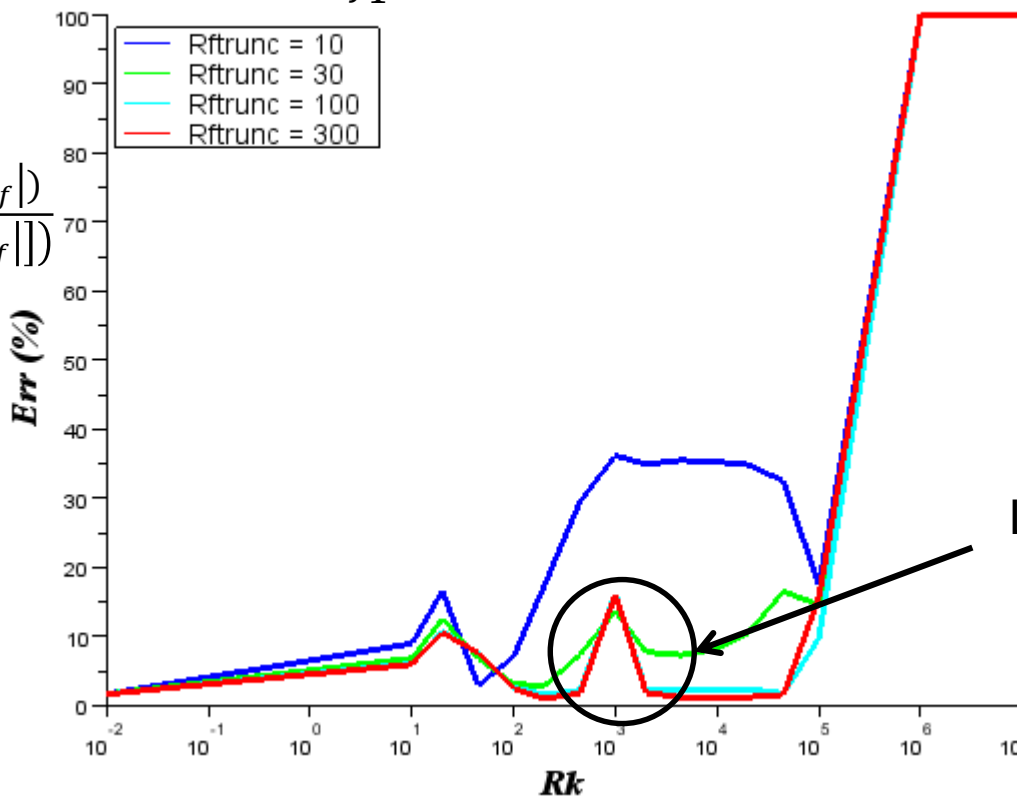

Local error when  
 $t_{contact} \approx t_{bending\ waves}$

$$R_k = \frac{K_{spring}}{K_{bending}}$$

# Clamped beam colliding on a spring

## Validation - Frequency truncation

$$\text{Err} = \frac{\max(|\Gamma_{num} - \Gamma_{ref}|)}{\max(|\Gamma_{num}|, |\Gamma_{ref}|)}$$

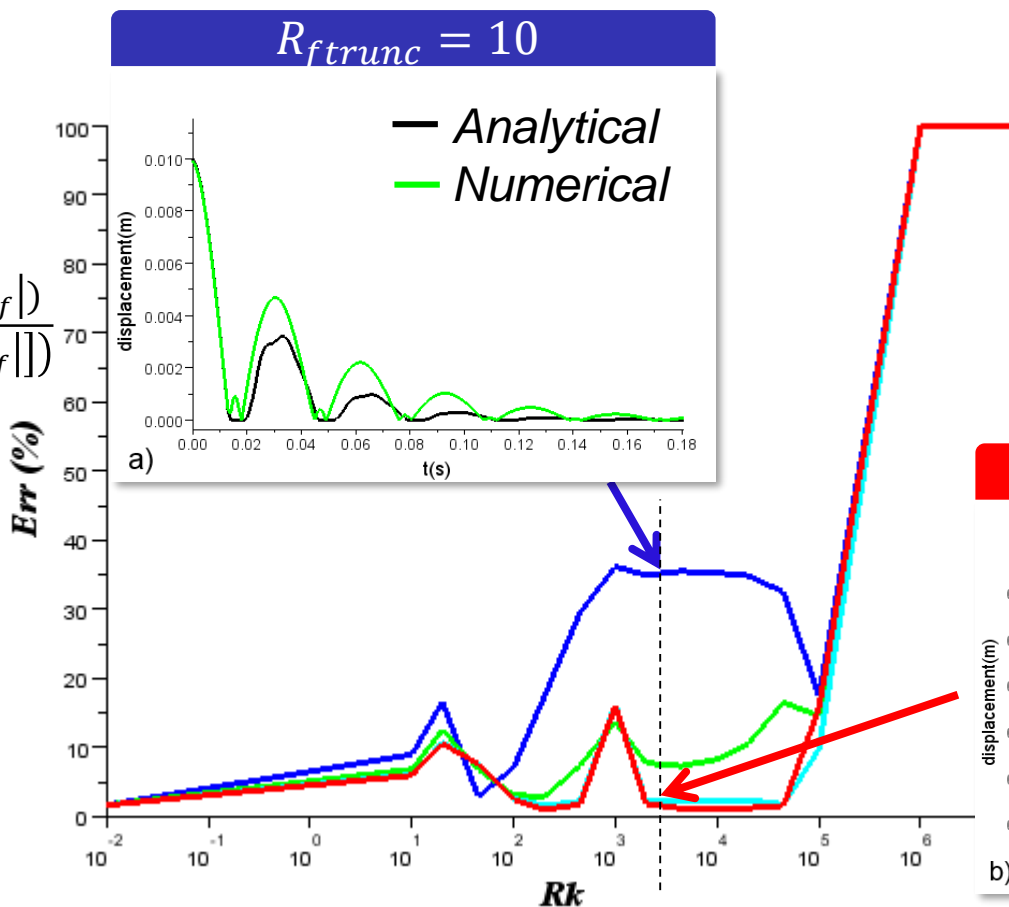

- A high frequency truncation is necessary when  $R_k$  is high.

# Clamped beam colliding on a spring

## Validation – Time step

$$\text{Err} = \frac{\max(|\Gamma_{num} - \Gamma_{ref}|)}{\max(|\Gamma_{num}|, |\Gamma_{ref}|)}$$

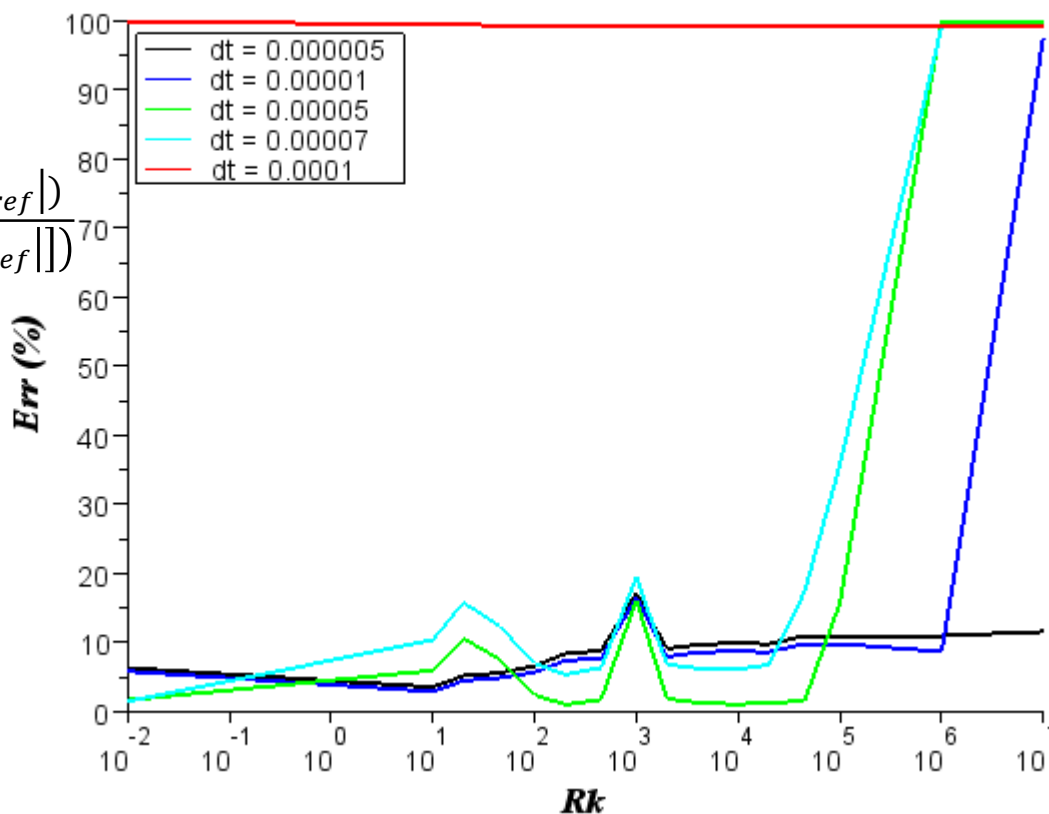

- A small time step is needed for a high  $R_k$
- A small time step doesn't mean a greater accuracy.

# Clamped beam colliding on a spring

$$\frac{1}{\pi} \sqrt{\frac{k_s}{m}}$$

*Frequency of the shock  
of a mass m*

$\ll$

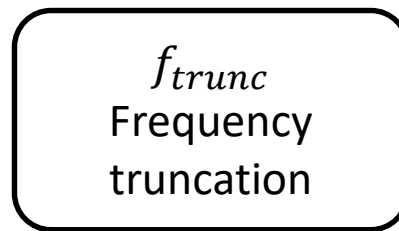

$<$

$$\frac{1}{4dt}$$

*Explicit scheme condition*

$$0,8 dt_{maxi}$$

*A small time step doesn't  
involve a greater accuracy*

$<$

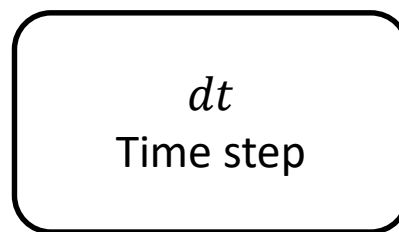

$<$

- $\frac{1}{4f_{trunc}}$
- $\frac{\pi}{2} \sqrt{\frac{m}{k_s}}$

*Explicit scheme*

*Time shock*

$\emptyset$

$<$

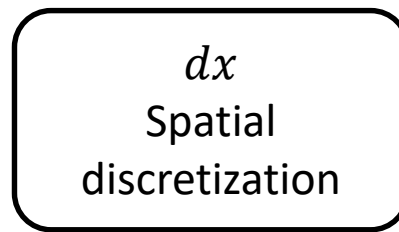

$<$

$$\frac{\lambda_{mini}}{4} = \frac{c_{bend}}{4f_{trunc}}$$

*Bending wave propagation*

# Dynamical behavior of a tube bundle

## ■ Application to the SFR tube bundle

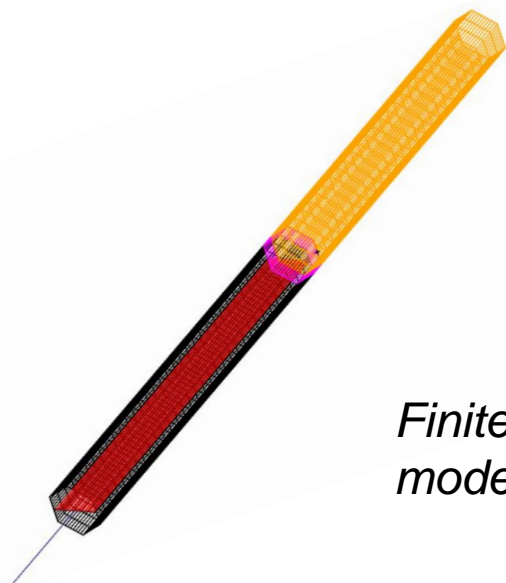

*Finite element model*

■ Fuel pins : Timoshenko beams

■ Wrapper tube : Shells

One row modeled (~500 contact zones)

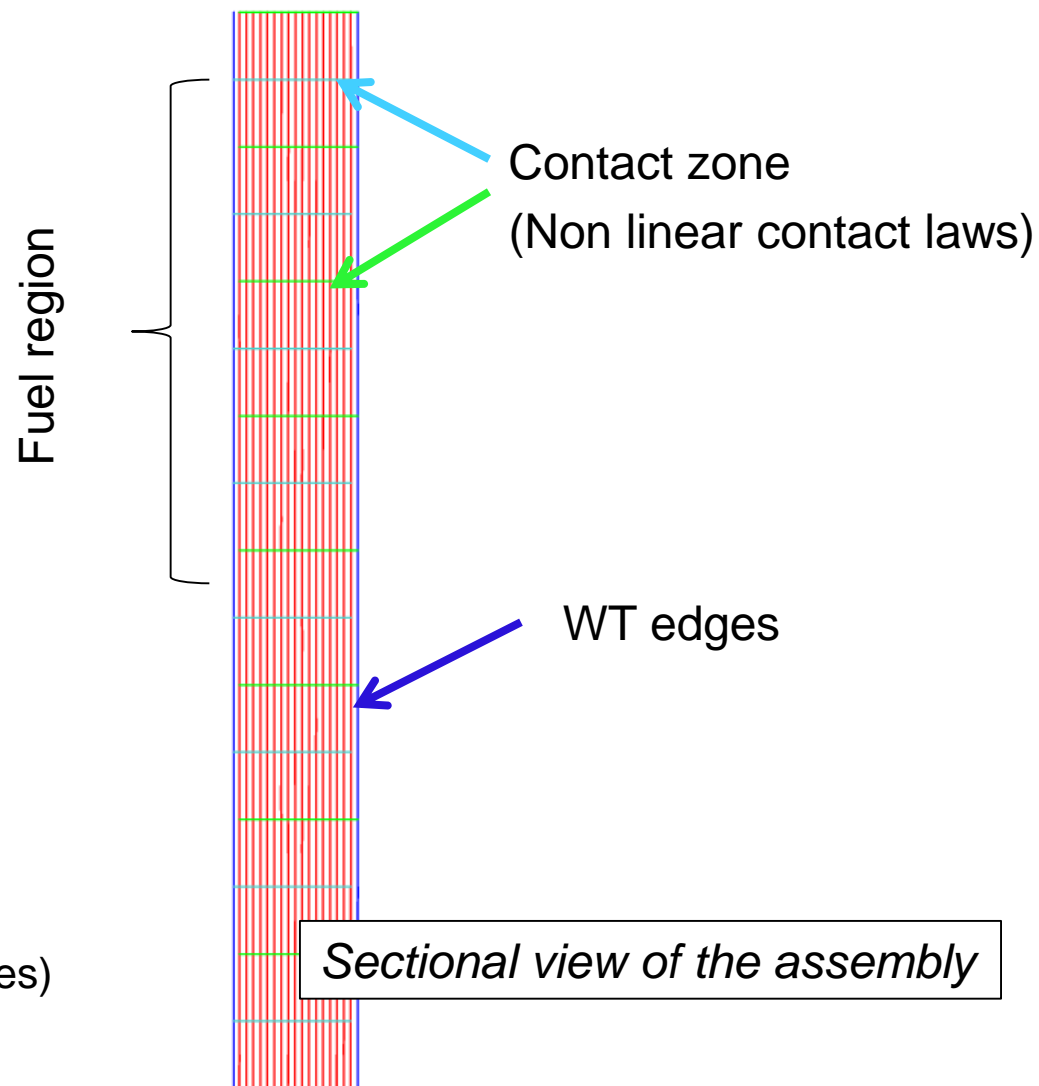

# Dynamical behavior of a tube bundle

## Release of an assembly in bending on a rigid stop

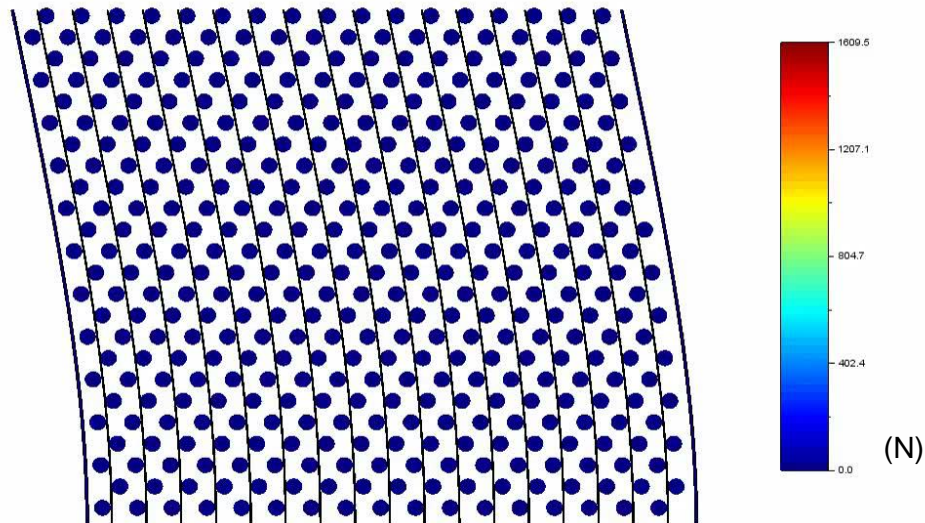

### Several phenomena at different time scale

- WT contact time (~20ms)
- WT breathing waves (~15ms)
- Compression waves in the bundle (~3ms)
- Bending waves in the bundle (~5ms)
- Local phenomena in a contact zone if there is a gap (<0.5ms)

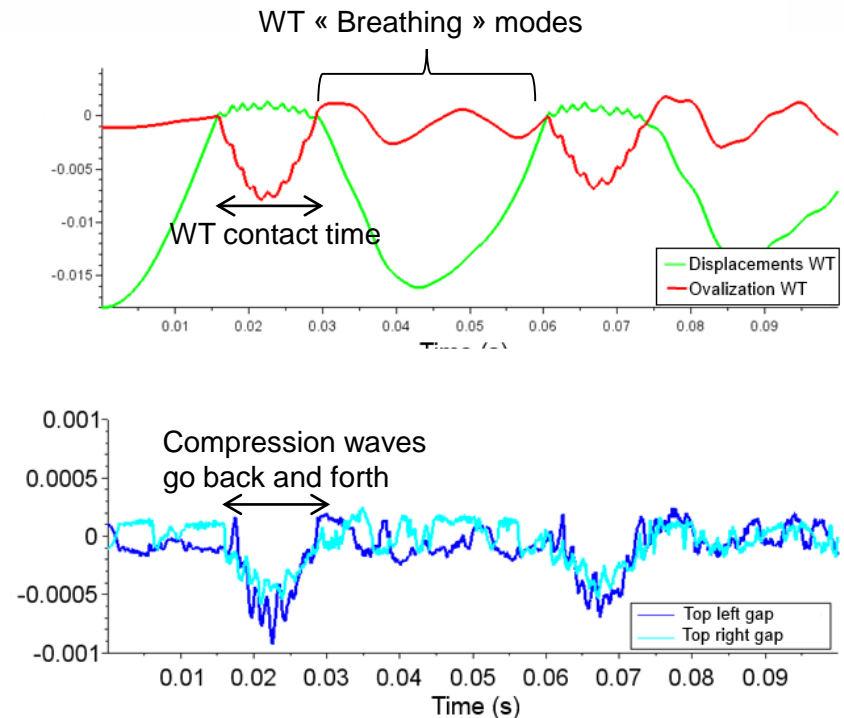

# Dynamical behavior of a tube bundle

## ■ Peak force depending on clearance

■ Linear decrease with clearance

■ Similar to a Newton's cradle behavior

*Donahue 2008*

*Hutzler 2004*

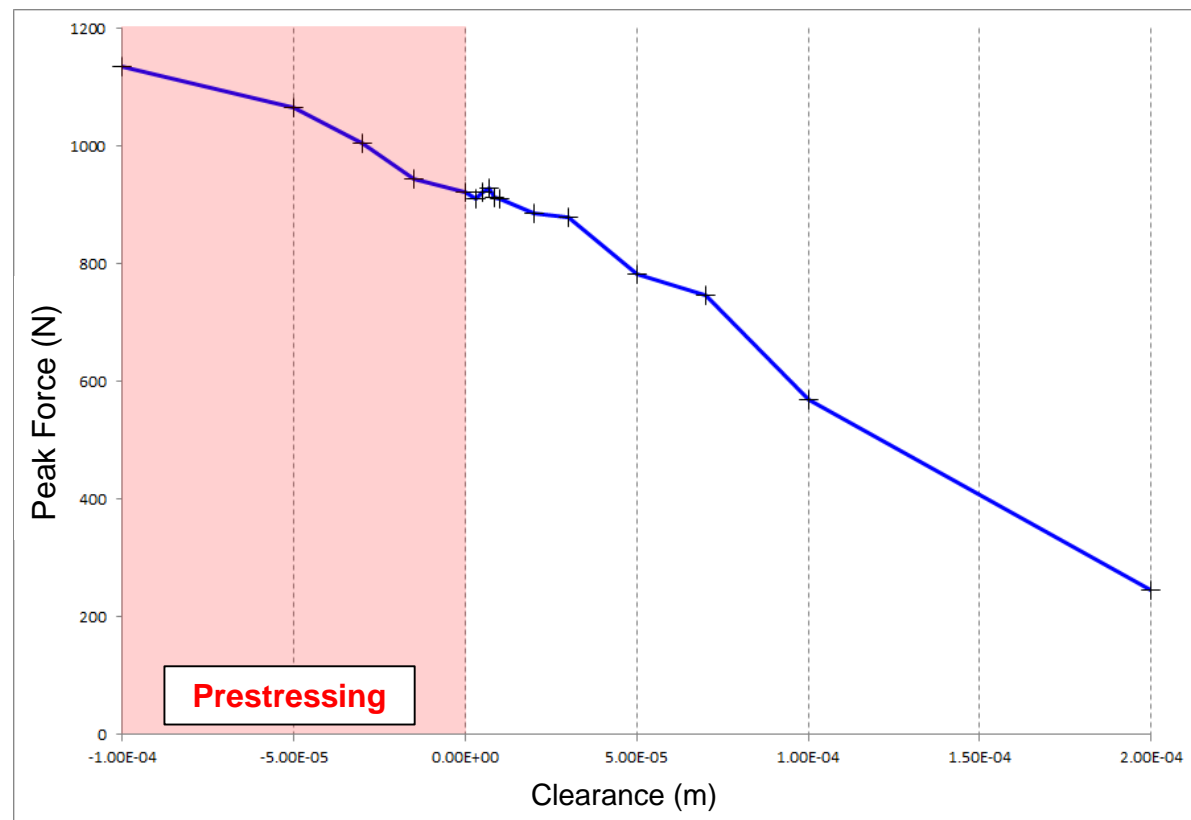



# Conclusion and outlook

## ■ Analytical validation of a contact problem

- Semi-analytical solution
- Numerical method choice
- Creation of a validity domain of the numerical model

## ■ Application to a pin bundle

- Several phenomena highlighted.
- Beneficial impact of clearance size for an homogeneous distribution.

## ■ Outlooks

- Study of heterogeneous distribution of clearances.
- Experimental validation
- Influence of the fluid

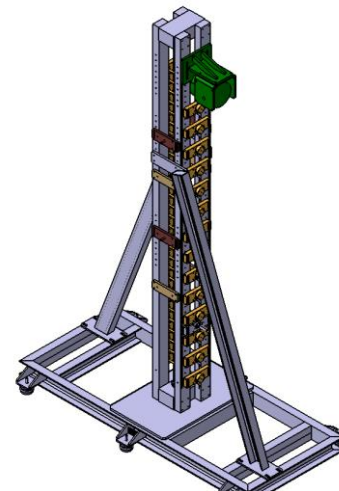

Thanks for your attention.

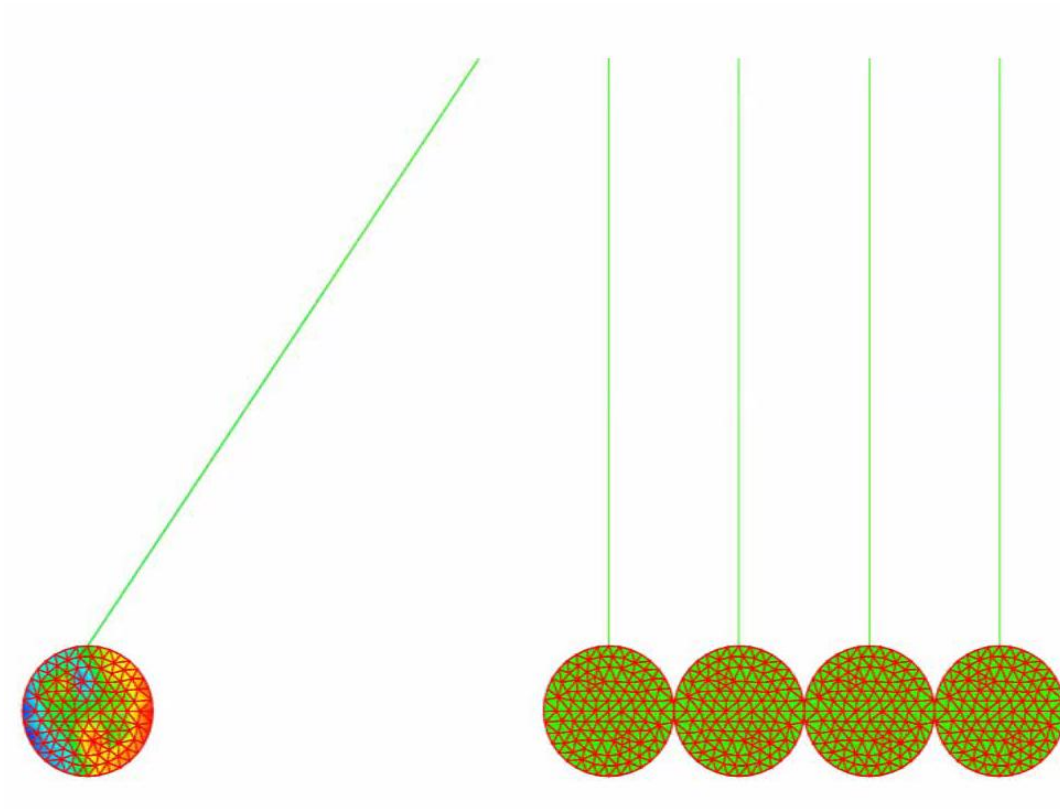

## Rationale of the selection of timoshenko beam.

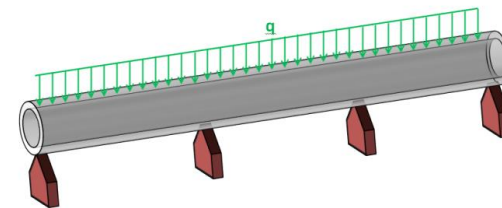
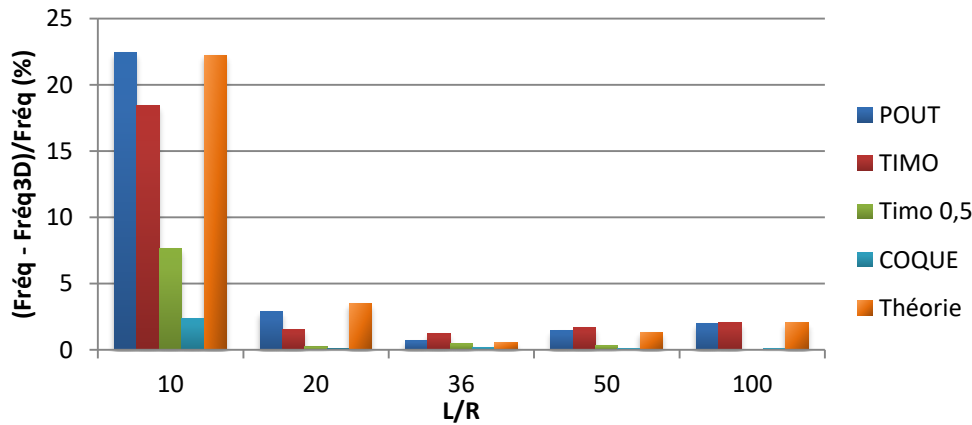
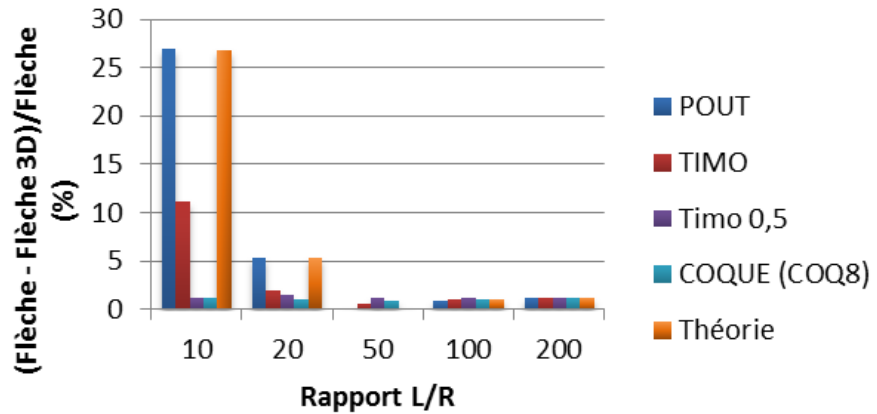
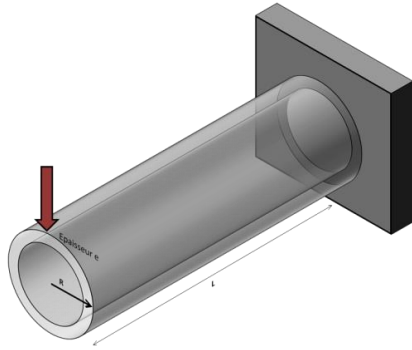

- Contact law

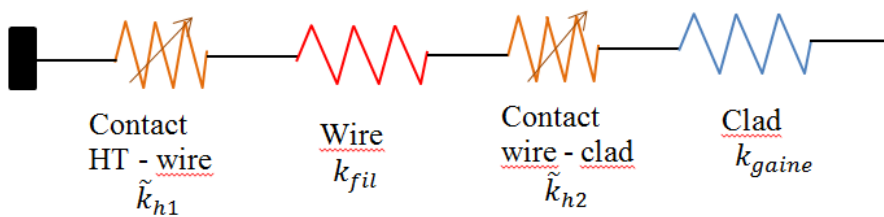
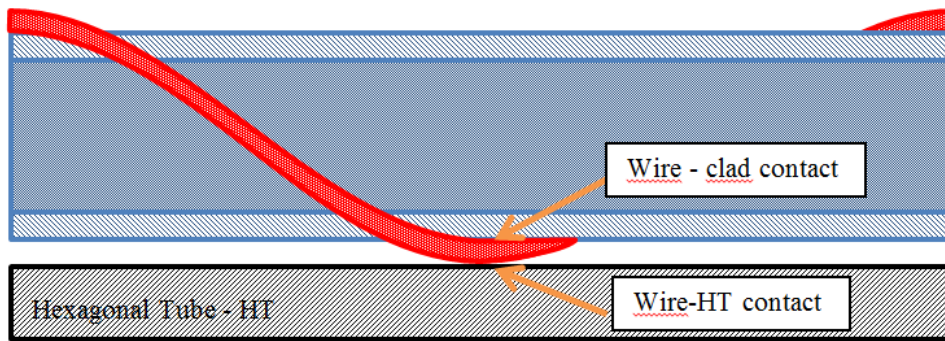

**Hertzian spring**

$$F = \tilde{k} \delta^{\frac{3}{2}}$$

**Linear spring**

$$F = k \delta$$

- Non-linear stiffness : Hertz theory
- Shell stiffness : [Millard 1981] , [Madureira 2004,2010,2015]

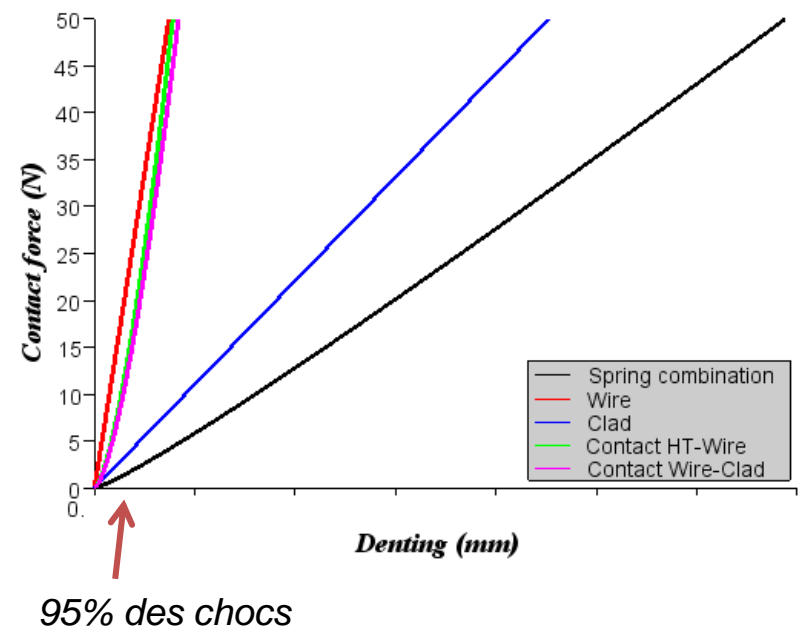

- Sub-structuring

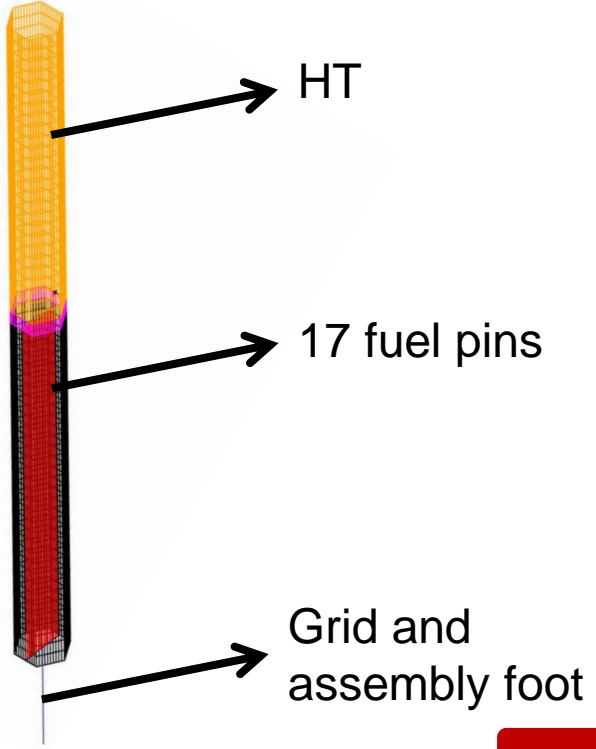

**Modal analysis**  
 $\Phi_{HT}, \Phi_{pin_1}, \dots$

**Connectivity mode**  
 $\Psi_{c1}, \Psi_{c2}, \dots$

$$x = \Sigma \Phi_i q_i + \Sigma \psi_j q_{Lj},$$
$$B_r = [\Phi, \Psi]$$

$$\hat{K} = B_r^t K B_r \quad \text{et} \quad \hat{M} = B_r^t M B_r$$

**Modal analysis on  $\hat{K}$  and  $\hat{M}$**   
*Eigenvalues and Eigenvectors written on  $B_r$*



**Modal recombination**  
*Eigenvalues and Eigenvectors written on physical basis*