

Thermodynamics
of the uranium defluorination process
and its application
for efficient recycling of fluorine
in the nuclear fuel cycle

J.M. Borgard, F. Herbelet, B. Gwinner, J.L. Fleche
DEN/DPC/SCCME DEN/DTEC/SCGS

Recommended pathway for fluor recycling in the nuclear fuel cycle



What we want !

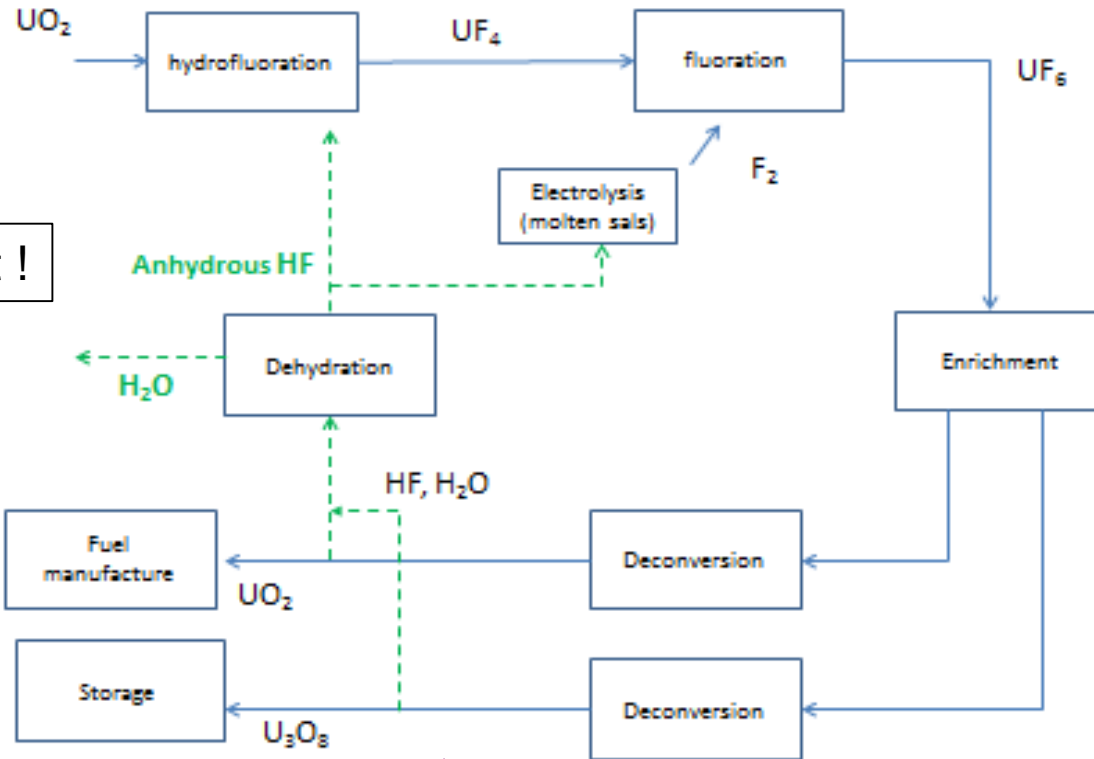

What we get !

The thermodynamical issue :

Liquid-vapor equilibrium of HF/H₂O at 1 bar

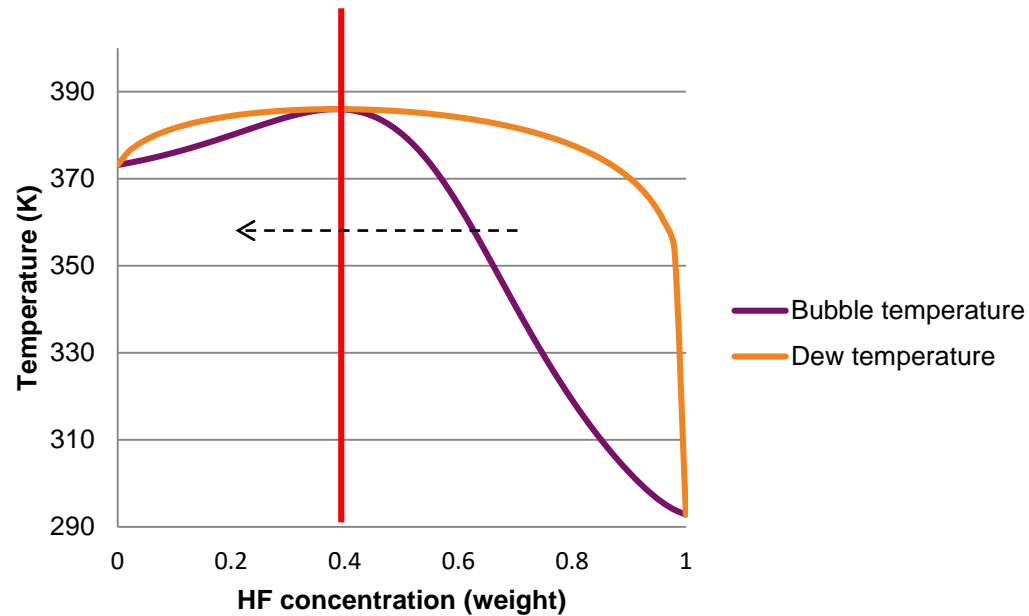

How can we get over the azeotrop ?

Effect of HF concentration on corrosion of Cu-Ni alloy

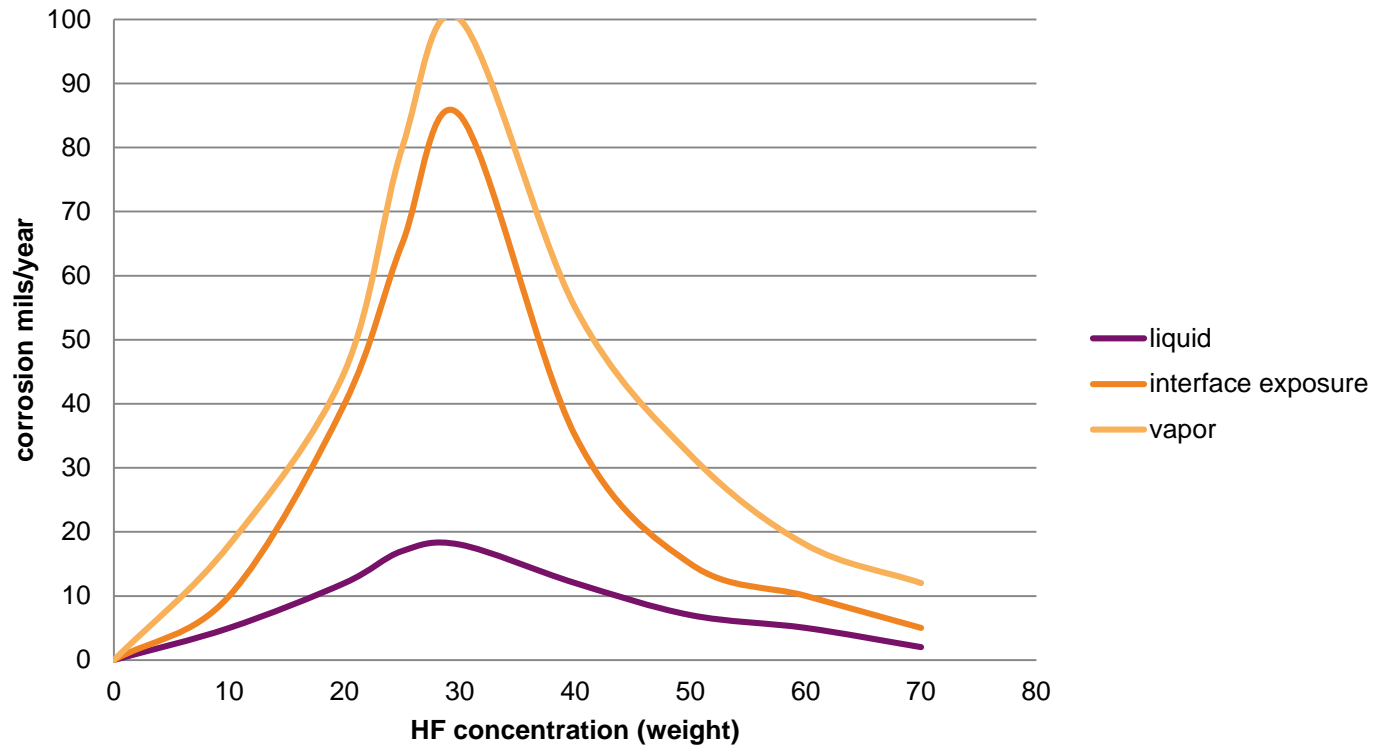

T=60°C, 1% O₂ in purge gas, Test time = 7 days

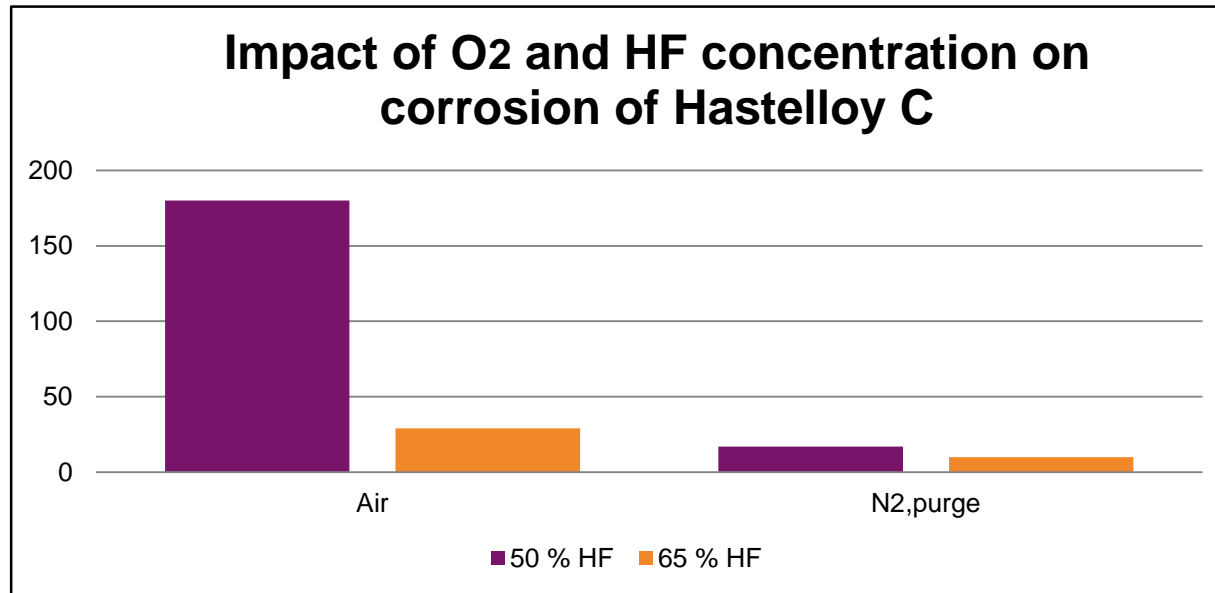

Solutions to limit corrosion:

- Avoid the azeotropic zone
- Avoid/limit O₂

Main steps of the defluorination process

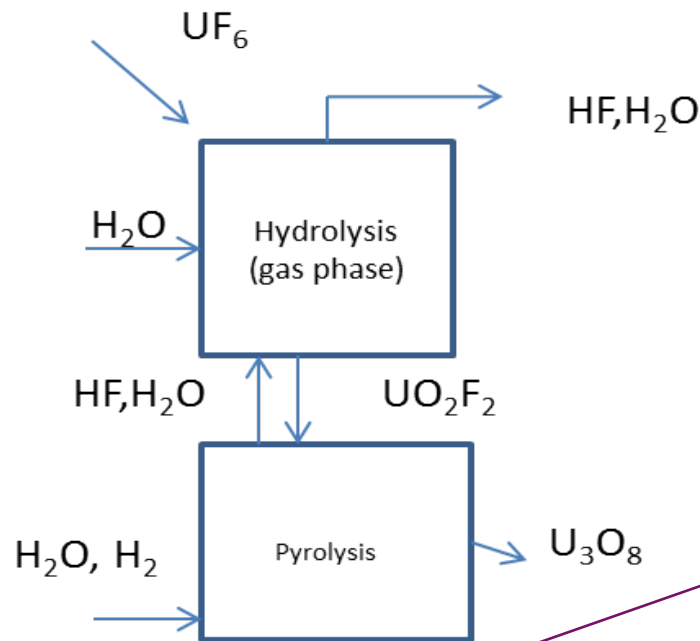

Use chemical reactions to remove extra water (Morel, JFC 2009)

Hydrolysis :



Pyrolysis :

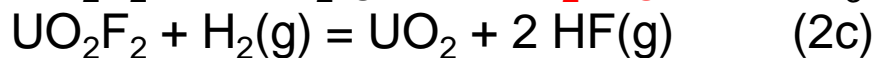

Chemical dewatering options to be discussed :

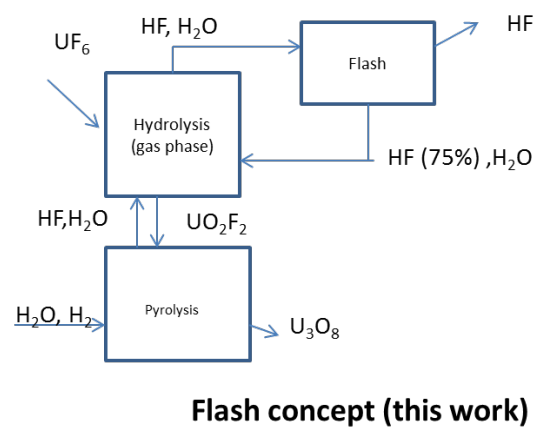
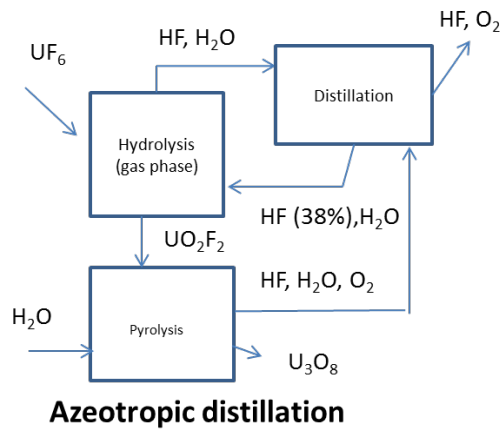
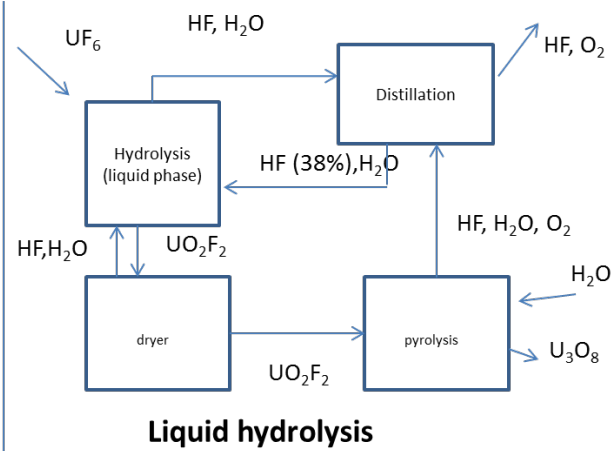
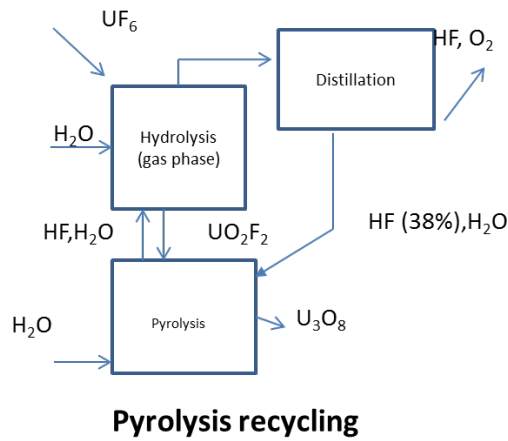

Option 1 : Pyrolysis dewatering

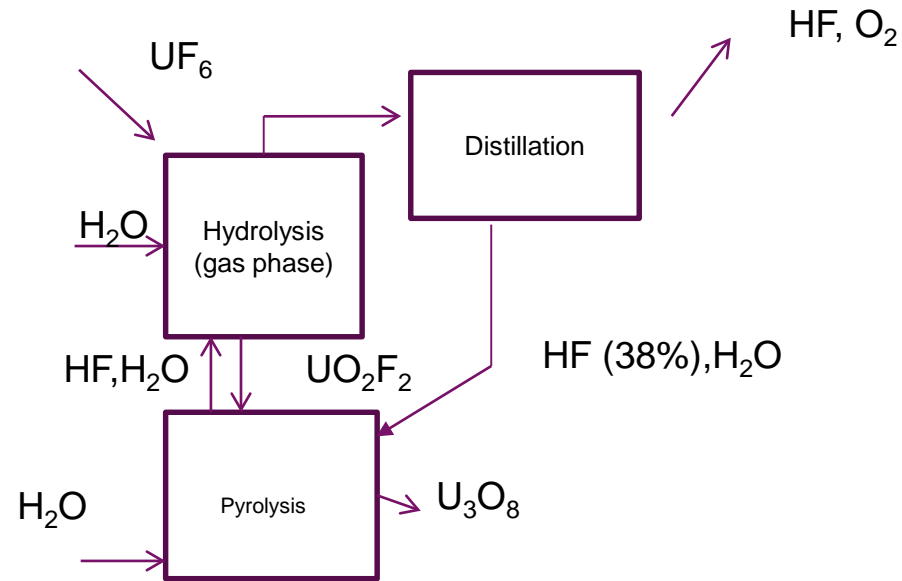

Dewatering equation :

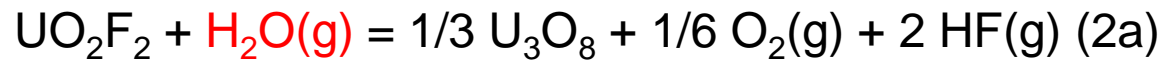

Pyrolysis recycling thermodynamical issue

Mikrokinetic model* : 3 majors steps :

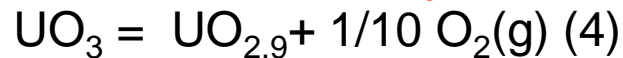

Followed by either :

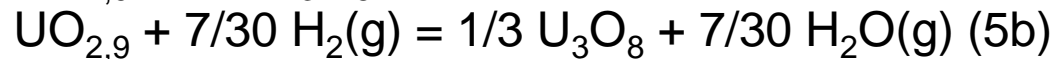
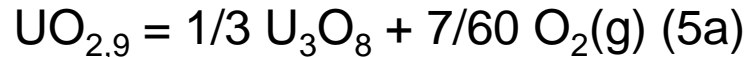

Issue :

Equation (3) : **DG ≈ 0** in operational temperature range
recycling HF => slow down the process and impact purity of U₃O₈ product

Pyrolysis dewatering : concept

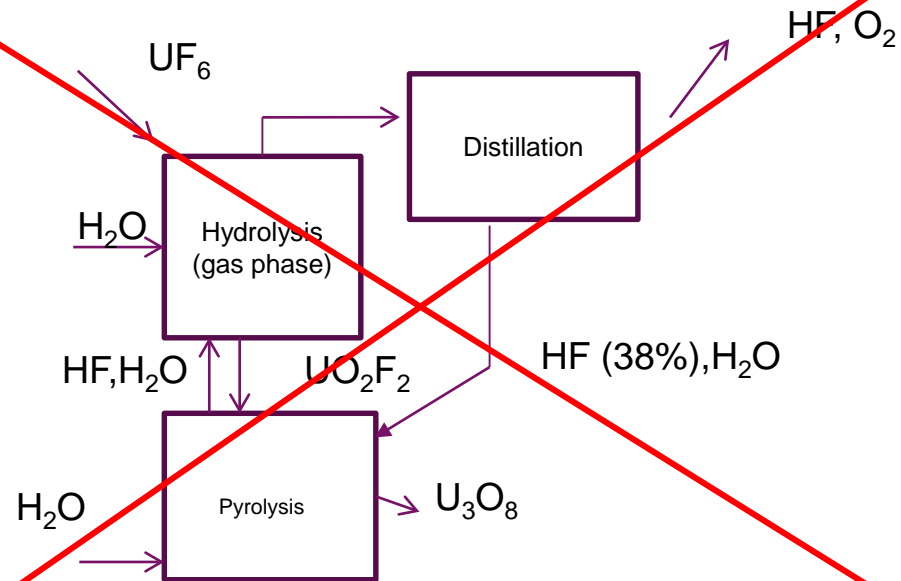

Too Slow

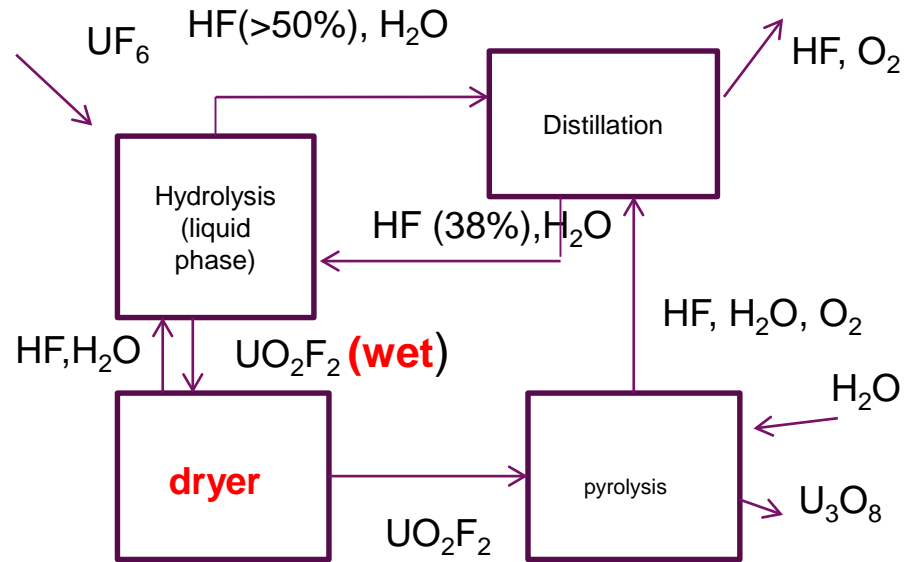

Equation :

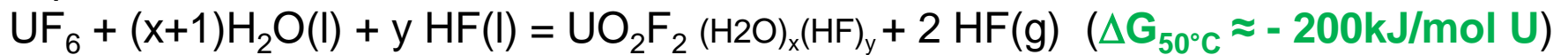

!! large amount H_2O / HF in the solid product

Liquid phase HF% weight	Wet residue HF % weight	Wet residue UO ₃ % weight	Drying energetic cost kJ/mol UO ₂ F ₂
51.41	37.97	31.26	1397
64.69	49.16	22.6	2167
70.11	55.77	19.13	2562
78.64	61.31	20.1	3057
91.4	76.07	14.11	3145

Too high energetic cost !

Option 3 : Dewatering using gaseous pyrolysis

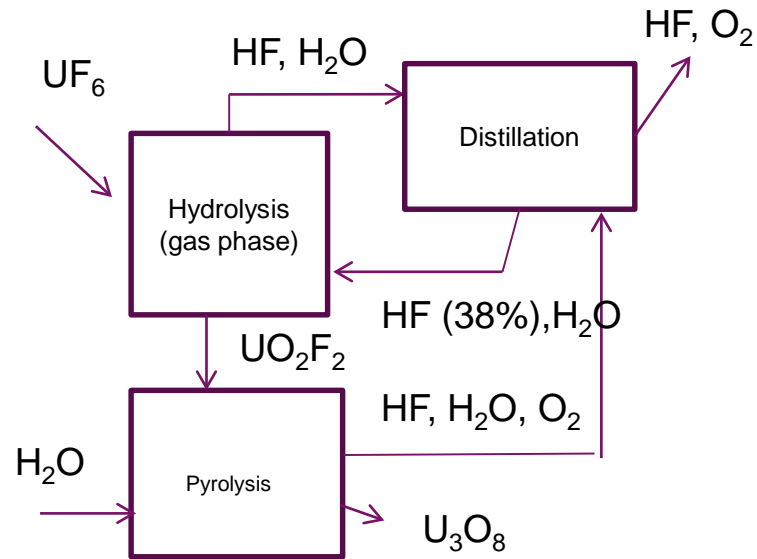

Sequoyah Fuel pilote scheme

Mikrokinetic modeling :

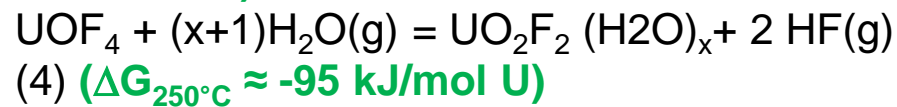
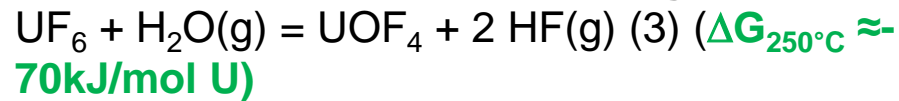

Looks good but two majors issues on the pilot plant :

Option 3 : the issue in the distillation column

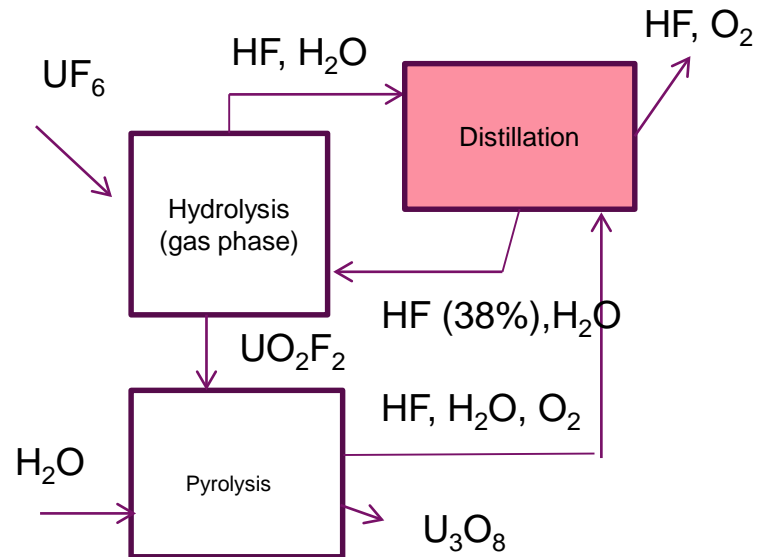

- Distillation of HF-H₂O **azeotropic** mixture with **O₂** : major **corrosion issue!**
- **Stability** of the distillation column with variable H₂O/HF input due to side-reactions in hydrolyser

Gaseous exit : side-reactions

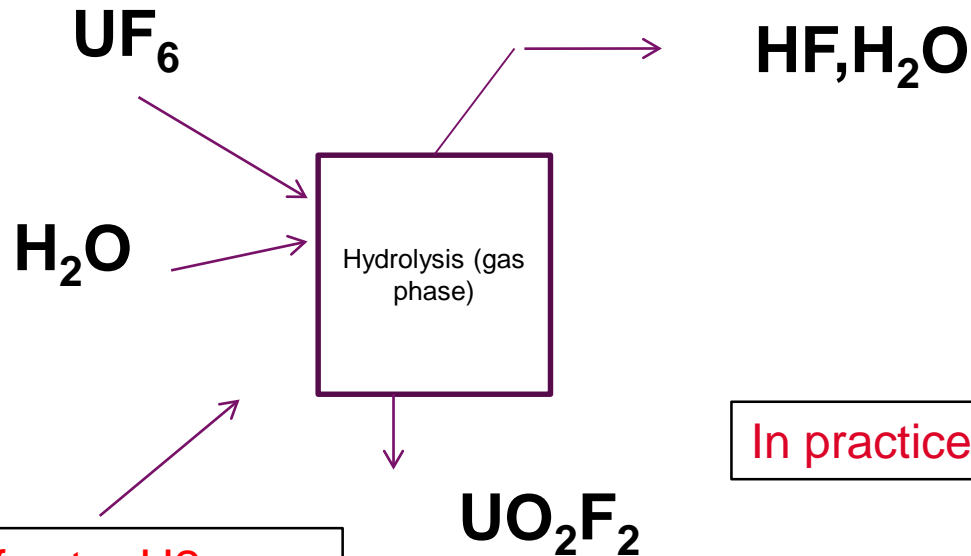

If extra H₂
possible UF₄
side-reaction

In practice hydrated (variable from 0 to 2 H₂O)

Partial decomposition in hot points

All contribute to variable HF-H₂O output in the recycling loop

Option 4 : Overazeotropic flash :

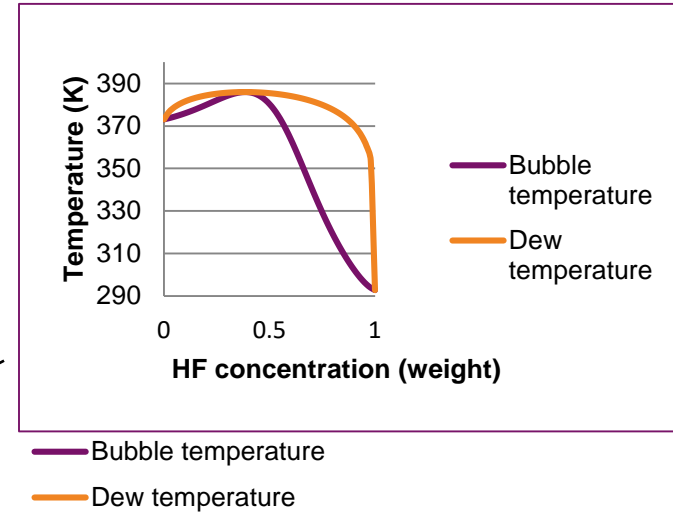
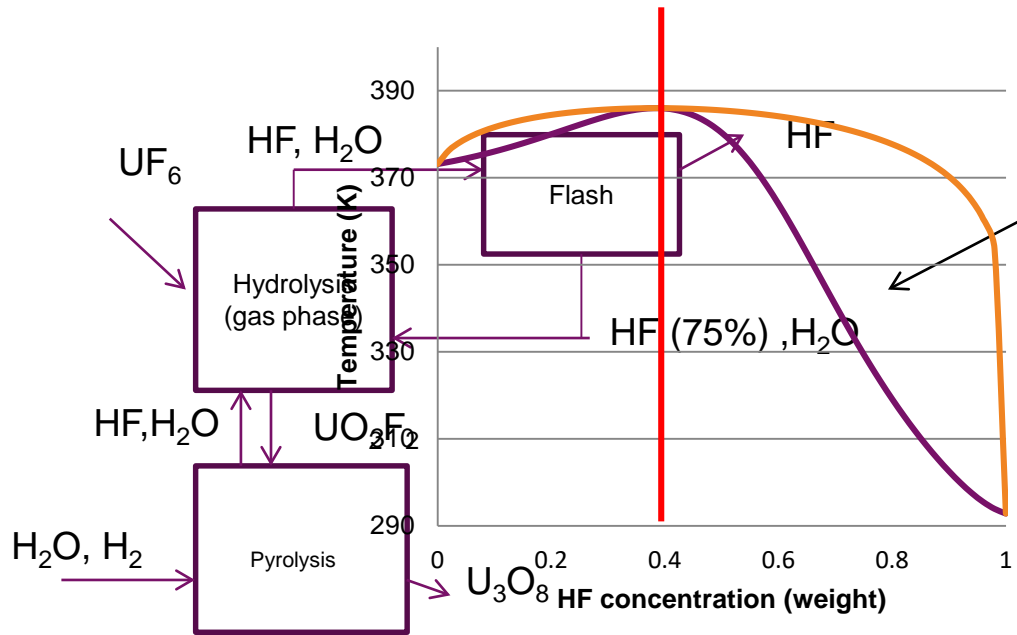

COMPARING OPTIONS:

	Pyrolysis recycling	Hydrolysis recycling + Azeotropic distillation	Liquid hydrolysis	Overazeotropic Flash
Corrosion in recycling loop	high	high	high	low
extra energy cost ((kJ/mol U)	> 700	250 (+ 360 cold source)	1500-4000	200-300
Recycling loop stability	Weak + quality of product issue	weak	Average	good

Conclusion :

Recycling fluorine in nuclear fuel :

Main thermodynamical issue : azeotrop in HF-H₂O mixture

Corrosion issue : high close to azeotropic point

According to Thermodynamics :

- Dewatering possible using UF₆ hydrolysis chemical reaction and chemical loop (pyrolysis of uranyl difluoride not recommended)
- Use of overazeotropic range HF instead of azeotropic recommended to limit corrosion
- Efficient separation can be done using a simple flash in high concentrated acid

Thanks for your attention !!

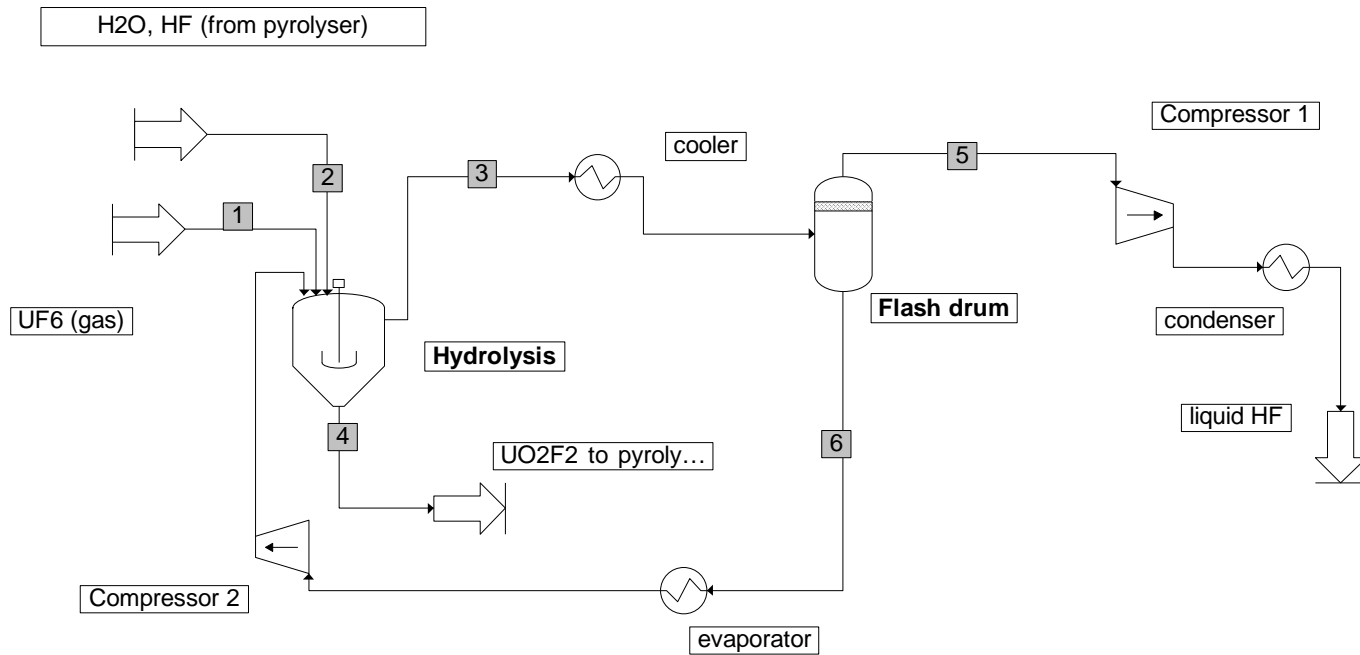

Simulation results

Component	Aqueous HF	Azeotropic distillation	Overazeotropic flash
Hydrolyser	- 80 kJ (200°C)	- 80 kJ (200°C)	- 80 kJ (200°C)
Cooler	- 298kJ (200-50°C) - 24 kJ (0°C)	- 130 kJ (200-120°C) - 30 kJ (120-25°C)	- 306 kJ (200°C-75°C) - 200 kJ (75-25°C)
HF separation unit	Not applicable	104. kJ (110°C) - 355 kJ (20°C)	- 75 kJ (50°C)
AHF compressor	Not applicable	30 kJ (el)	30 kJ (el)
AHF condensor and cooler	Not applicable	- 145 kJ (65°C) - 12 kJ (20°C)	- 145 kJ (65°C) - 12 kJ (20°C)
Boiler	80 kJ (100°C, pure water)	146 kJ (110°C, 38% HF)	288 kJ (50-105°C, 75% HF)
Compressor HF/H ₂ O recycling loop	3 kJ (el)	5 kJ (el)	15 kJ(el)
Global energy demand after heat integration	80 kJ heat (200°C) 3 kJ (el)	80 kJ(200°C) 120 kJ (110°C) 35 kJ (el) Extra cooling required 367 kJ at 20°C	80 kJ (200°C) 45 kJ (el) Extra cooling required 212 kJ (75-20°C)

Heat integration

