

FROM RESEARCH TO INDUSTRY

cea den

CORROSION MONITORING

IN MIXTURE

CEMENT PASTE - BENTONITE

GLOBAL 2015 | J. AGULLO, C. BATAILLON & N. MICHAU

21/09/2015

- Context
- Experimental setup
- Corrosion monitoring
- Experimental results
- Conclusions

Vitrified waste cells

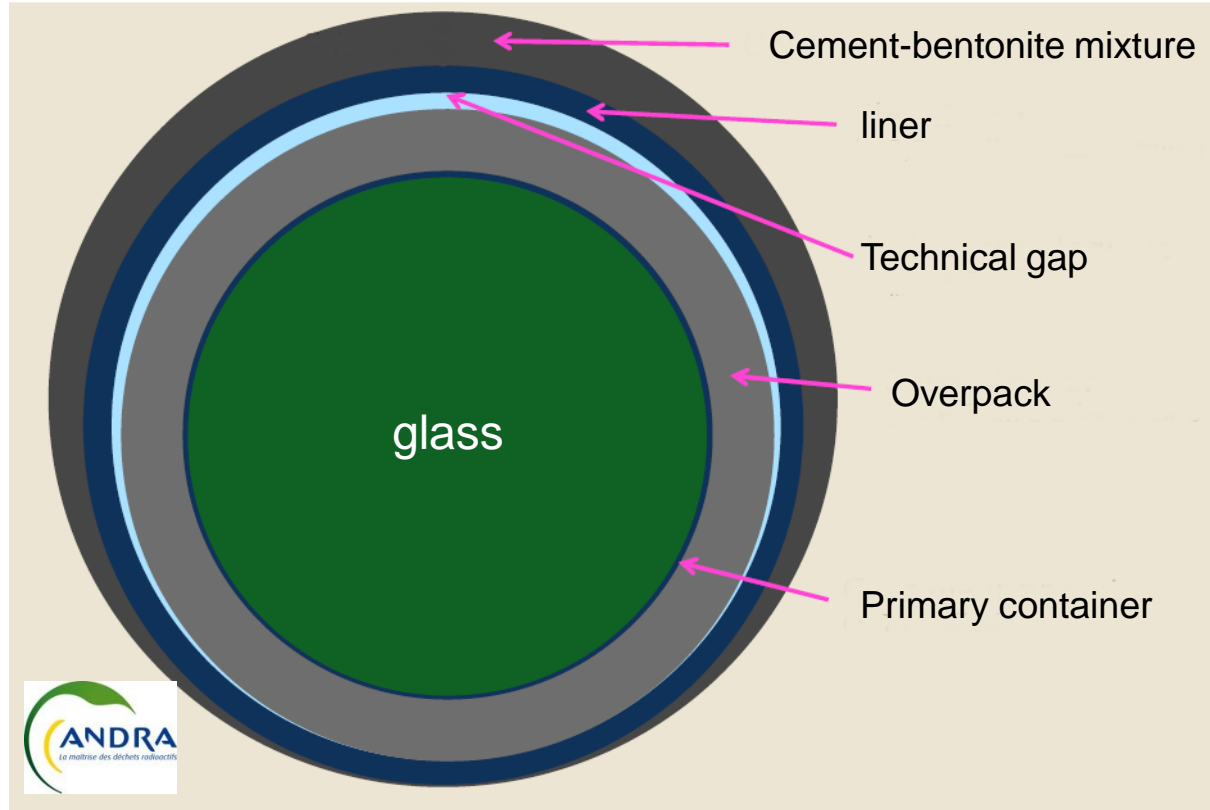

MAIN FUNCTIONS OF THE GROUT

- The first one is to neutralize the acidity due to the drilling oxidation of sulfur

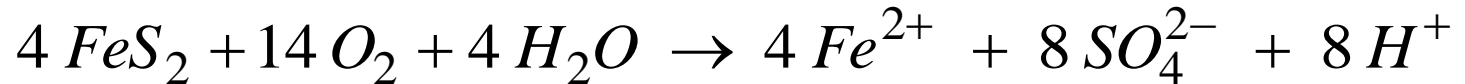

- The second one is to limit the oxygen diffusion along the cell to the claystone

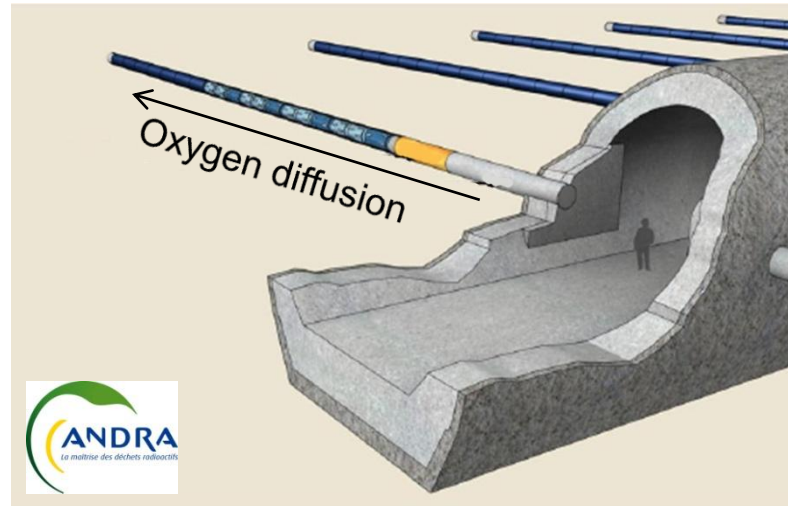

Figure 1. Sch ma g n ral d'une cellule de stockage de d chets G

H^+ and J_{O_2} increase the corrosion rate of carbon steel

ELECTROCHEMICAL EXPERIMENTAL SETUP



Temperature monitoring

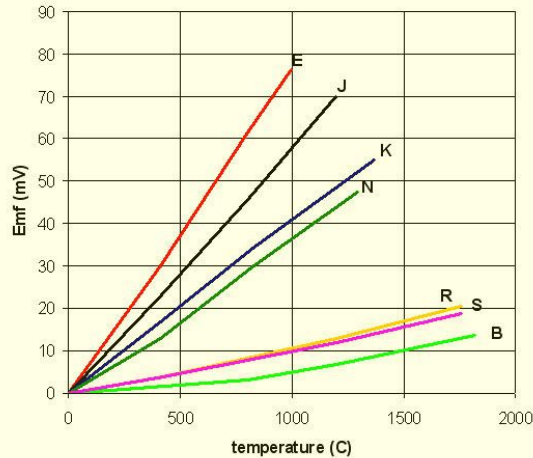
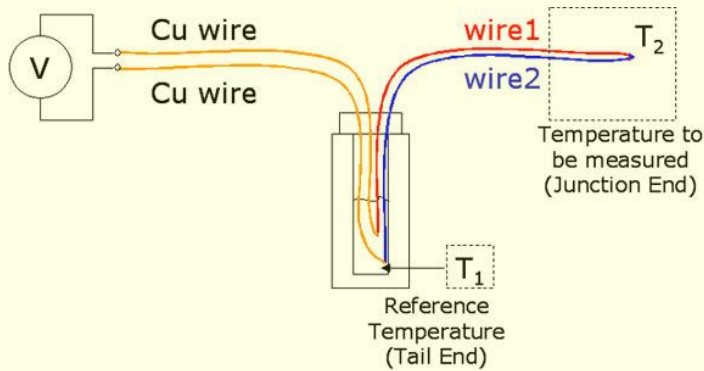

$$V \text{ (mV)} \xrightarrow{\text{Type K}} T \text{ (}^\circ\text{C)}$$

Corrosion monitoring

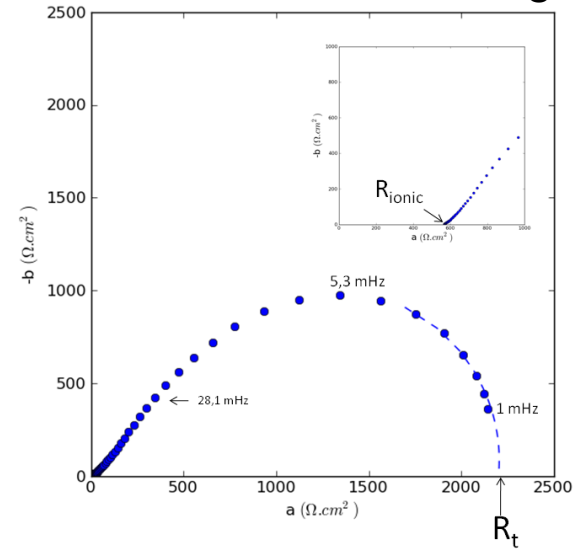

Stern-Geary method

$$j_{corr.} \text{ (A.cm}^{-2}\text{)} = \frac{1}{\alpha_a n_a + \alpha_c n_c} \frac{RT}{F} \frac{1}{R_t}$$

$$j_{corr.} \xrightarrow{\text{Faradays law}} v_{corr.} \text{ (}\mu\text{m/yr)}$$

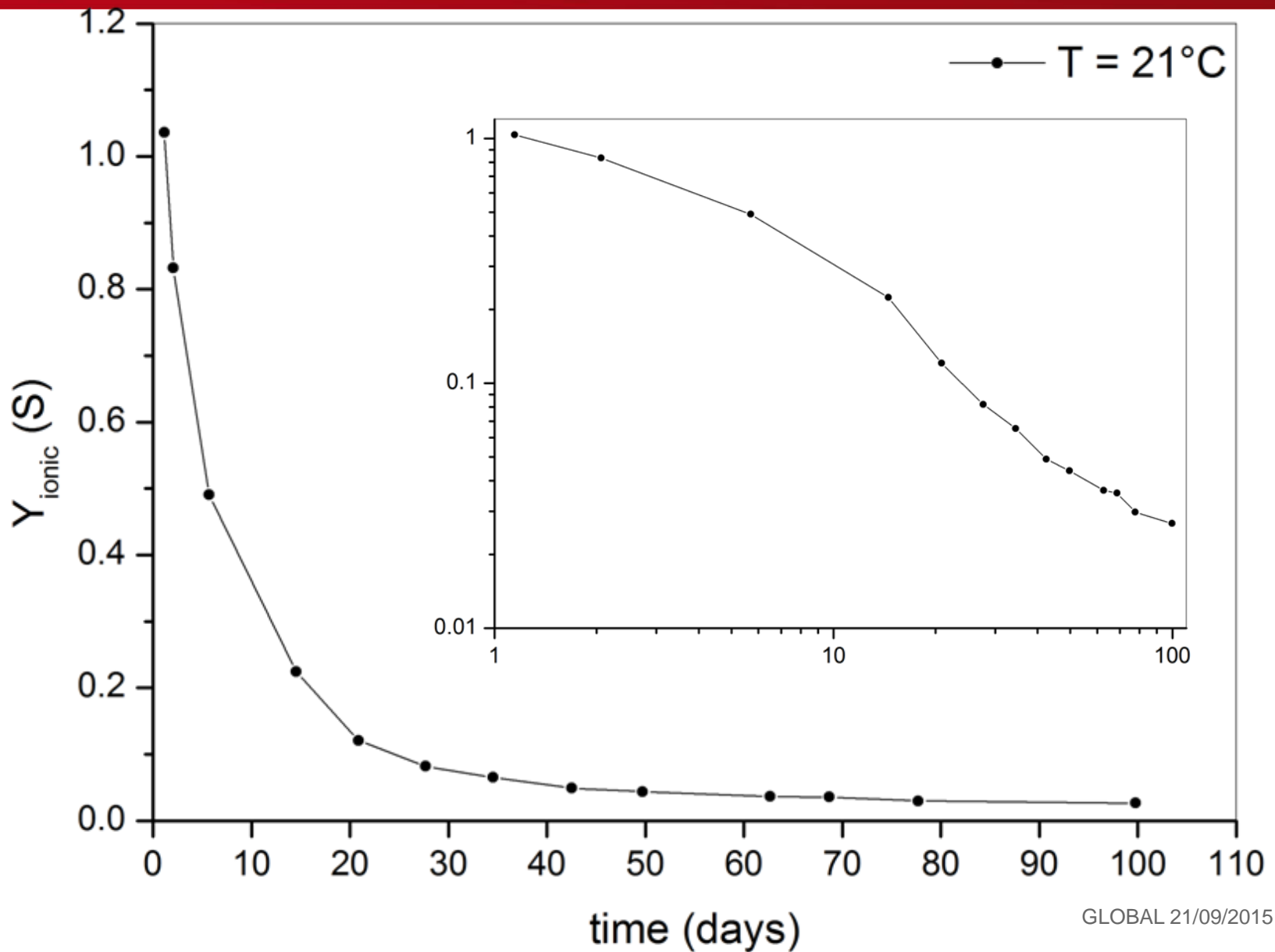

CORROSION RATE MONITORING

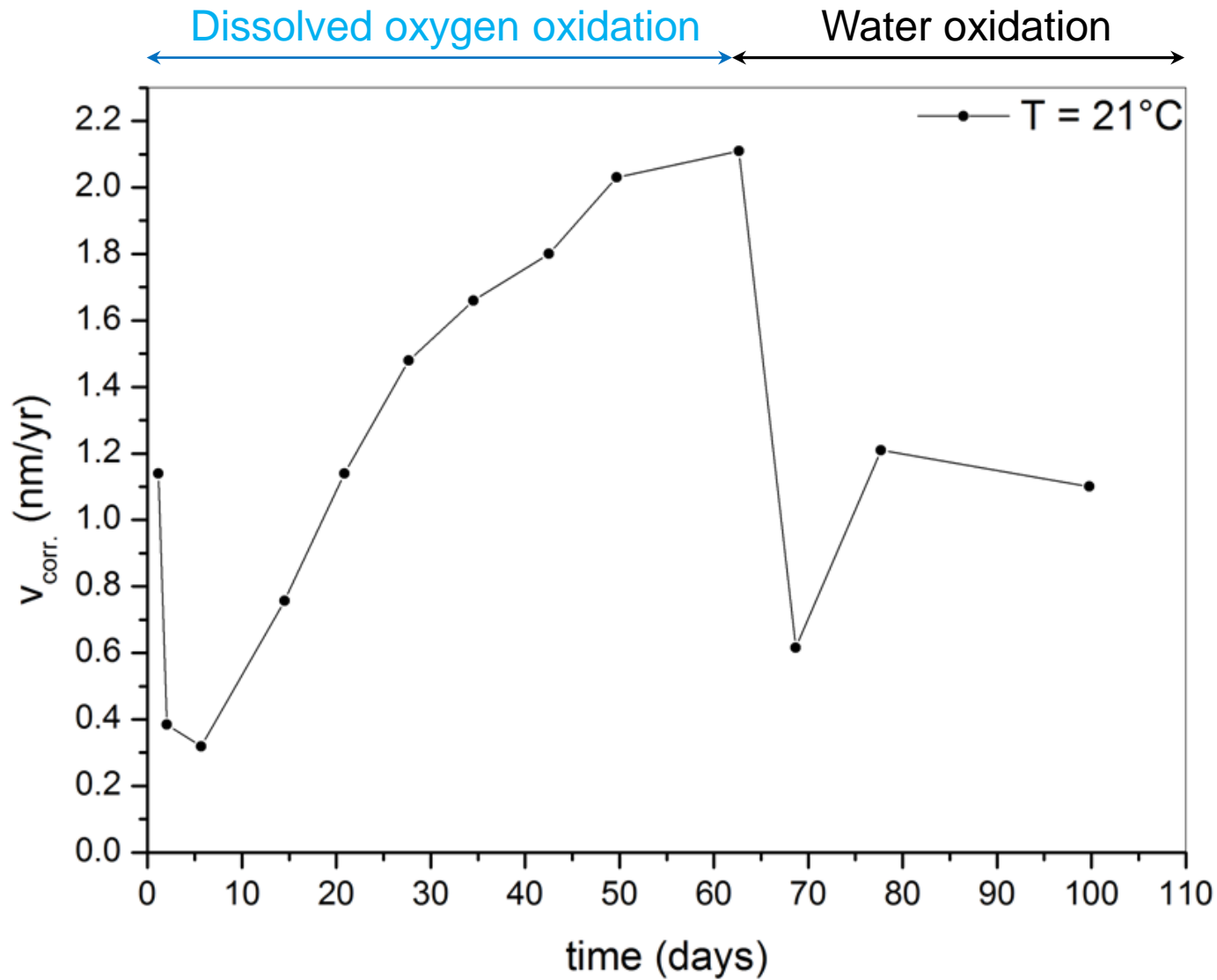

OPTICAL AND ELECTRONIC OBSERVATIONS

Initial surface state



After 100 days



System Vacuum = 1.09e-005 mbar | Probe = 100 pA | Signal A = SE1
Vacuum Mode = High Vacuum | EHT = 5.00 kV | Mag = 36 X
Chamber = 1.09e-003 Pa | WD = 24 mm



System Vacuum = 6.64e-006 mbar | Probe = 100 pA | Signal A = BSD
Vacuum Mode = High Vacuum | EHT = 15.00 kV | Mag = 35 X
Chamber = 6.64e-004 Pa | WD = 11 mm

CONCLUSIONS

- The corrosion rate has increased during the aerated period up to about 2-8 nm/year.
- Then the corrosion rate has decreased down to about 1-4 nm/year in anaerobic condition.
- At the moment there is no evidence in EIS measurements to ensure that steel was passivated. It could be in an inactive state (or inhibited state).
- The lowest limit for gravimetric measurements is about 20-50 nm. This implies that about 10 years long experiment would be needed to reach such low limit.
- EIS measurement is more accurate because it counts electrons exchanged between the anodic and cathodic processes.

Commissariat à l'énergie atomique et aux énergies alternatives
Centre de Saclay | 91191 Gif-sur-Yvette Cedex
T. +33 (0)1 XX XX XX XX | F. +33 (0)1 XX XX XX XX

DEN
DPC
SCCME

Etablissement public à caractère industriel et commercial | RCS Paris B 775 685 019