



HAL
open science

SCC crack initiation of alloy 82 in hydrogenated steam at 400 degrees c

C. Guerre, J. Crepin, M. Sennour, C. Duhamel, E. Heripre, I. de Curieres

► **To cite this version:**

C. Guerre, J. Crepin, M. Sennour, C. Duhamel, E. Heripre, et al.. SCC crack initiation of alloy 82 in hydrogenated steam at 400 degrees c. Réunion annuelle de l'ICG EAC, May 2015, Ann Harbor, United States. cea-02500826

HAL Id: cea-02500826

<https://cea.hal.science/cea-02500826v1>

Submitted on 6 Mar 2020

HAL is a multi-disciplinary open access archive for the deposit and dissemination of scientific research documents, whether they are published or not. The documents may come from teaching and research institutions in France or abroad, or from public or private research centers.

L'archive ouverte pluridisciplinaire **HAL**, est destinée au dépôt et à la diffusion de documents scientifiques de niveau recherche, publiés ou non, émanant des établissements d'enseignement et de recherche français ou étrangers, des laboratoires publics ou privés.

SCC CRACK INITIATION OF ALLOY 82 IN HYDROGENATED STEAM AT 400°C

Elizabeth CHAUMUN^{1,2}

C. Guerre¹

J. Crépin², M. Sennour², C. Duhamel²

E. Héripré³

I. de Curières⁴

¹ CEA, DEN, DPC, SCCME, Laboratoire d'Etude de la Corrosion Aqueuse

² MINES Paris Tech, Centre des Matériaux

³ Ecole Polytechnique, Laboratoire de Mécanique des Solides

⁴ IRSN, Institut de Radioprotection et de Sûreté Nucléaire

DE LA RECHERCHE À L'INDUSTRIE

cea den

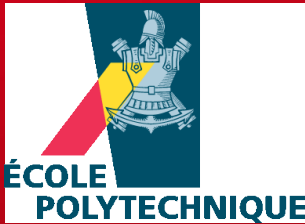

✓ SCC propagation tests [Guerre et al, 2011]

Alloy 82 CT specimen

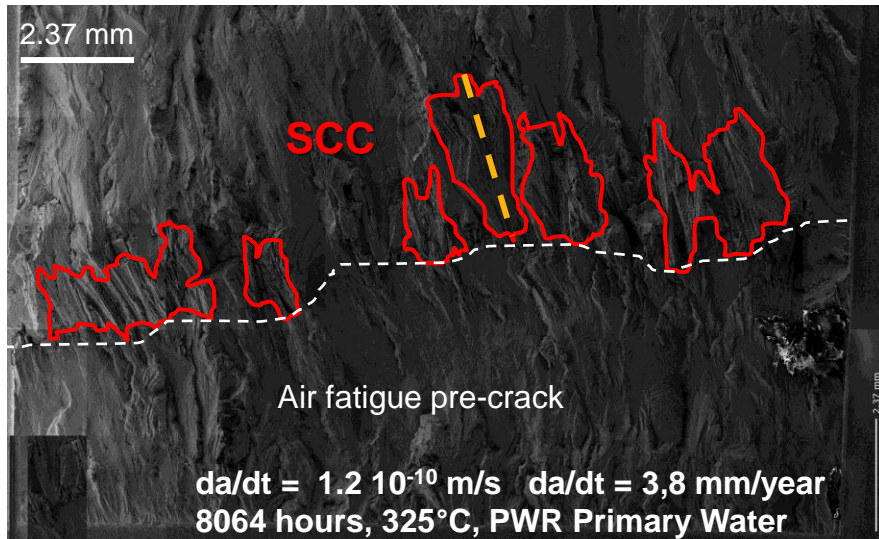

Maximum crack growth rate (m/s)

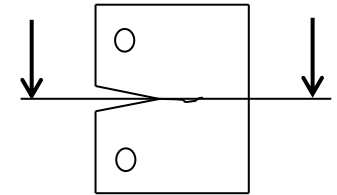
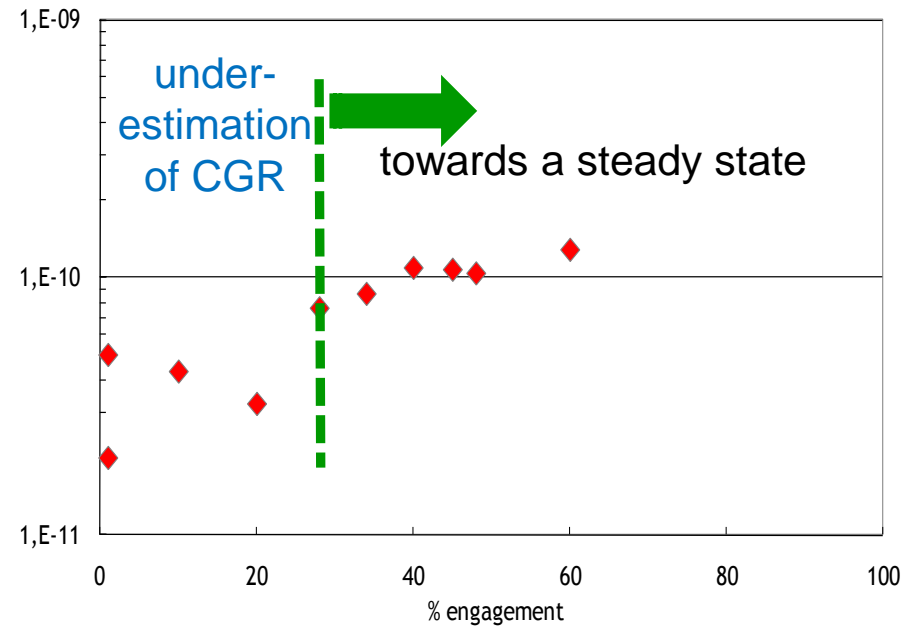

- Uneven crack front with pockets of IG cracks : % of engagement of the crack front is below 100%.
- Along susceptible grain boundaries, the crack growth rate can be very high (few mm/year).

→ **SCC behavior of welds is strongly related to their microstructure.**
→ **Life time depends on the initiation time.**

APPROACH AND AIM

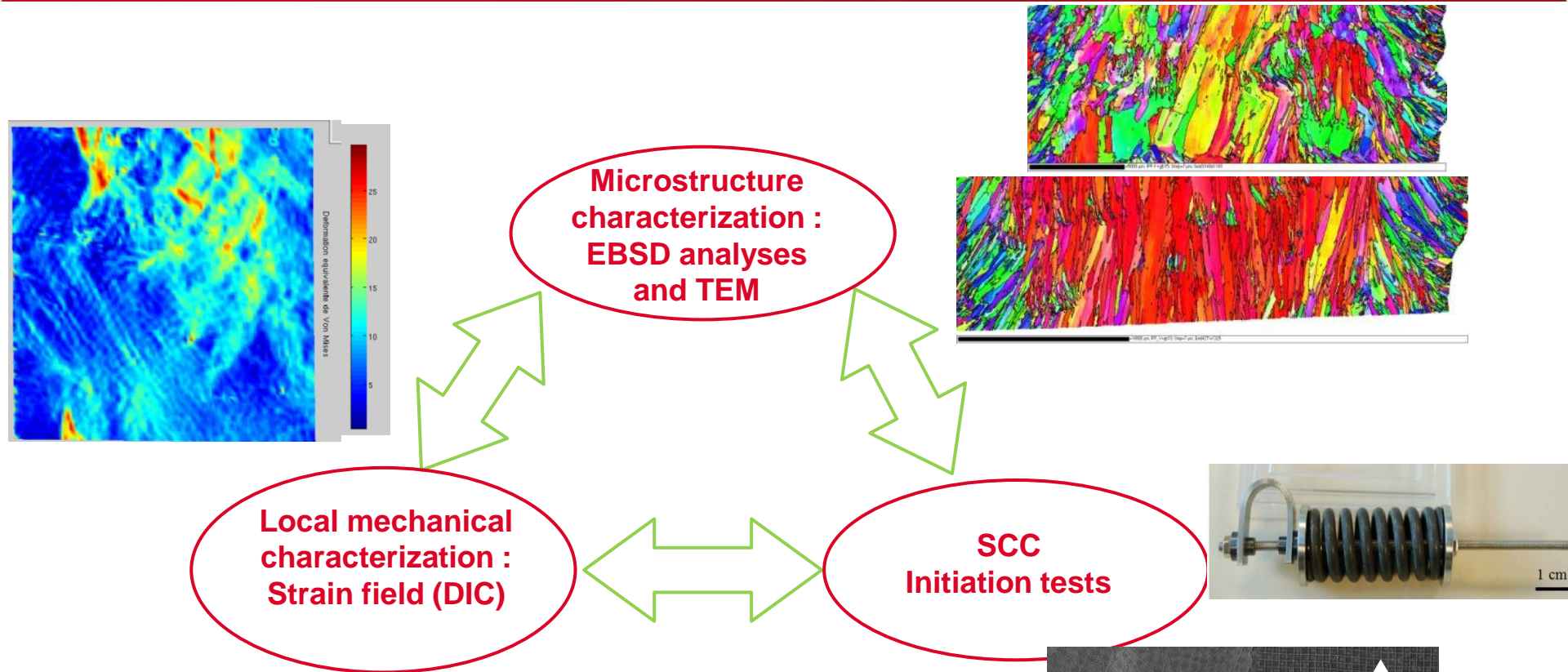

→ To identify which microstructural features associated with mechanical fields enable SCC initiation.

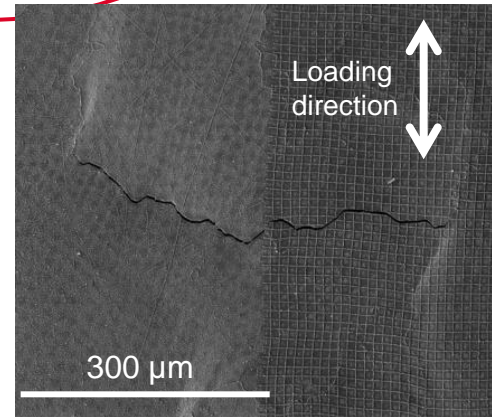

✓ Welds : Alloy 82 (no restraint)

- millimetric columnar grains made of several slightly misoriented dendrites

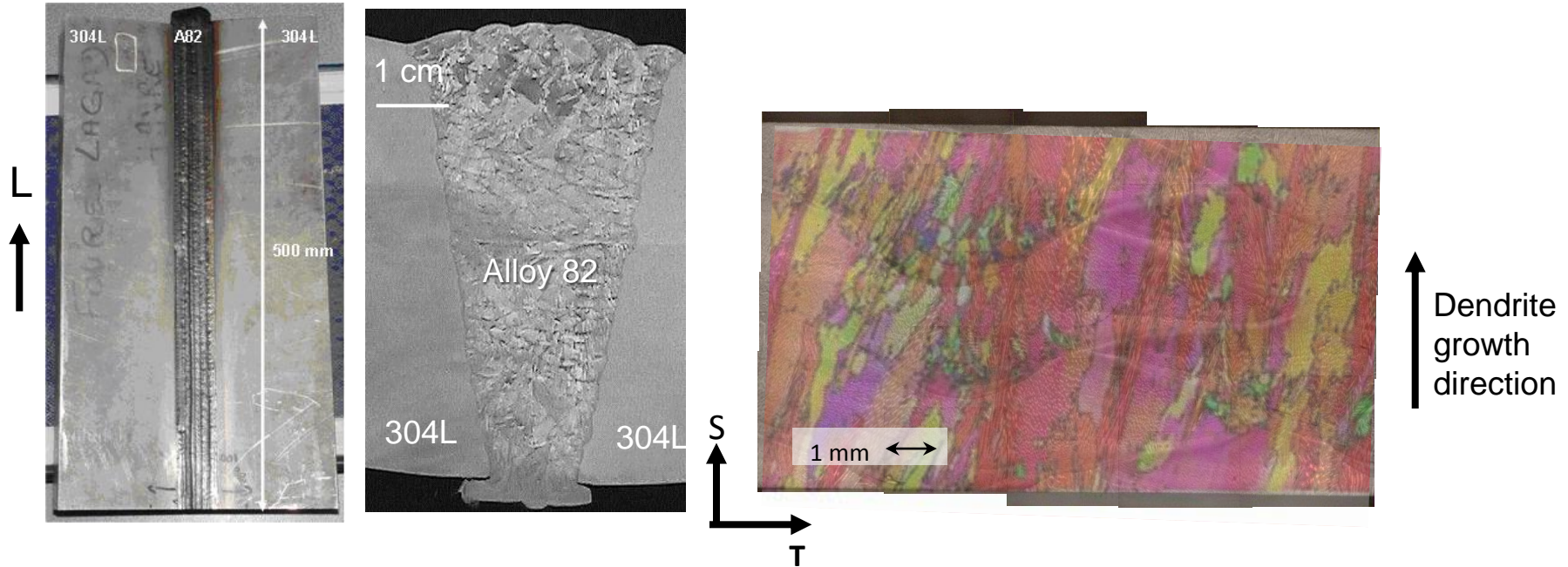

✓ Chemical composition of Alloy 82 (weight%)

	C	S	Si	Mn	Ni	Fe	Cu	Cr	Nb	Ti	P	Co	Mo	O
RCC-M requirements	<0.1	<0.015	<0.5	2.5/3.5	>67	<3	<0.5	18-22	2/3	<0.75	<0.03	<0.1	-	-
Alloy A	0.025	<0.001	0.07	2.57	71.7	3.07	<0.01	19.12	2.41	0.1	0.004	0.04	0.02	0.0016
Alloy B	0.014	0.017	0.17	2.88	72.9	2.3	<0.01	18.15	2.83	<0.01	0.002	0.01	0.05	0.067

Butt weld reference	Chromium content	Carbon content	Metallurgical state	Welding process
Alloy A (AW)	19%	0.025%	As-Welded	Gas Tungsten Arc Welding (GTAW)
Alloy A (HT)	19%	0.025%	Heat-Treated ¹ (7 hr @ 600°C)	Gas Tungsten Arc Welding (GTAW)
Alloy B (AW)	18%	0.014%	As-Welded	Flux Cored Arc Welding (FCAW)

¹ similar to the in-service stress relief treatment

□ Effect of the heat treatment on the precipitation:

- Alloy A : intergranular chromium carbides precipitation (Cr_{23}C_6)
- Alloy B : no IG chromium carbides

A82 19% Cr
Heat treated

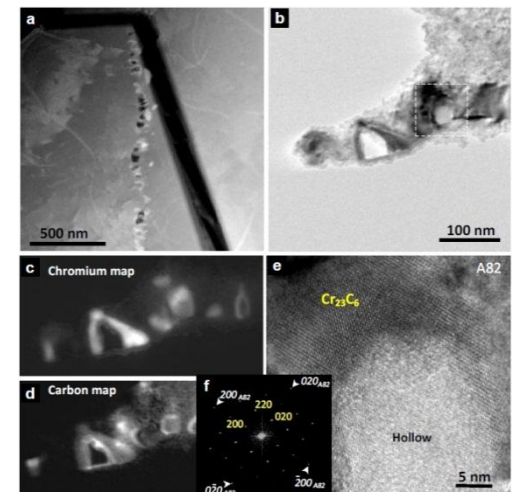

✓ EBSD analyses

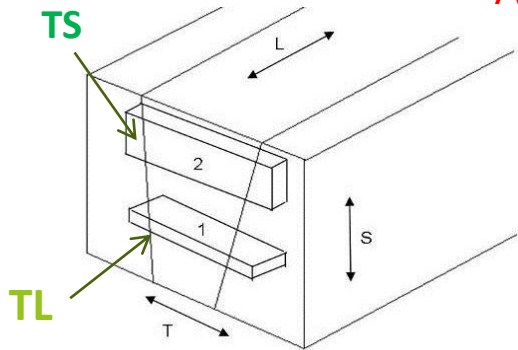

Alloy B
AW FCAW

Alloy A
AW GTAW

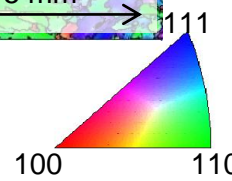
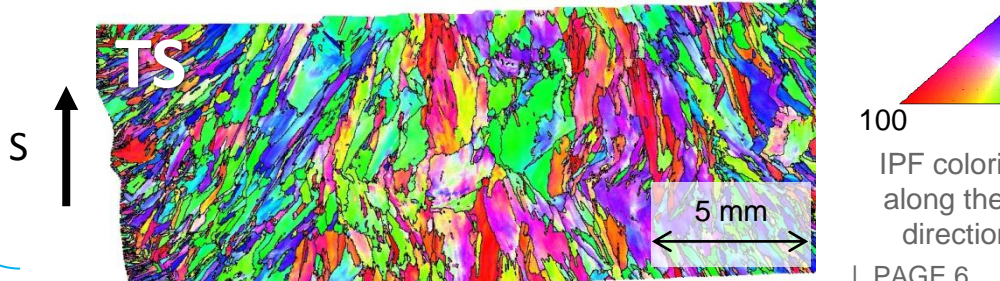
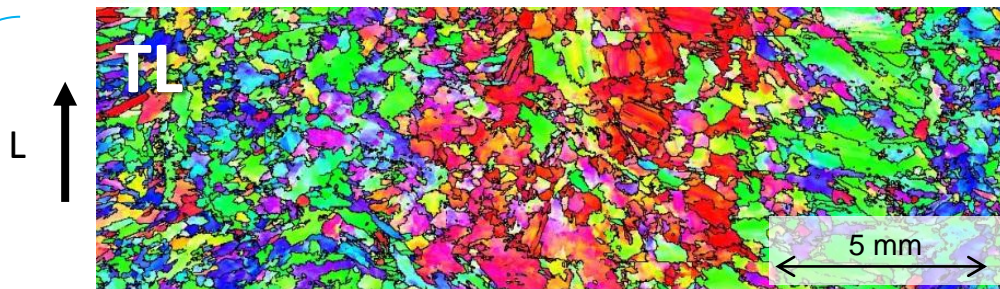
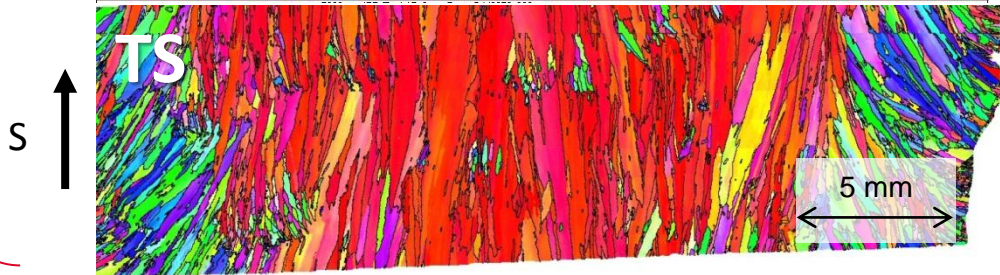
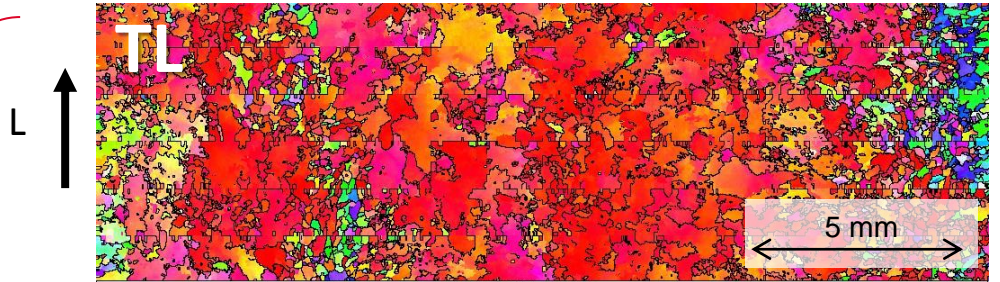

IPF coloring
along the S
direction

- ✓ Large grain size (mm) : macroscopic microstructure
- ✓ Heterogeneous grain size
- ✓ Nearly equiaxed shape (TL)
- ✓ Cristallographic texture isn't the same for the two alloys and depends on the welding process.

✓ EBSD analyses : crystallographic orientation

Alloy B

Cubic and transversal isotropic texture with [001] // dendrite growth direction

TL ↑
L

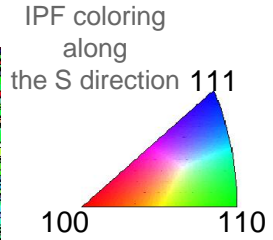
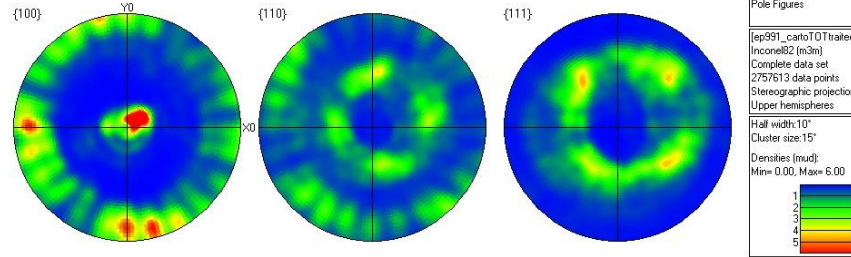
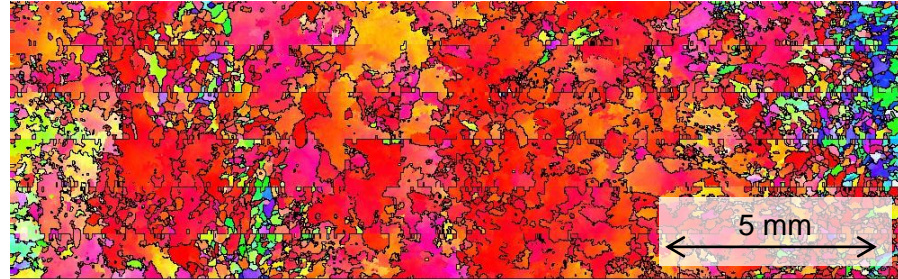

Alloy A

No crystallographic texture

TL ↑
L

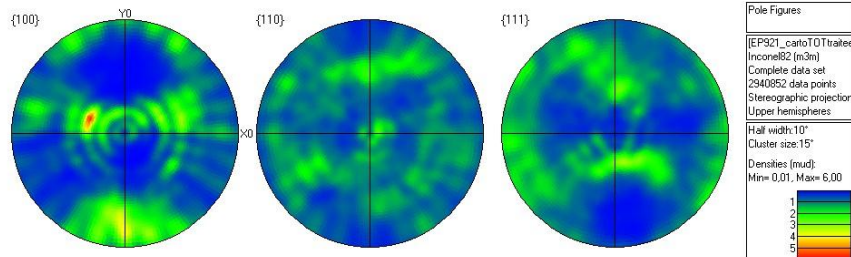
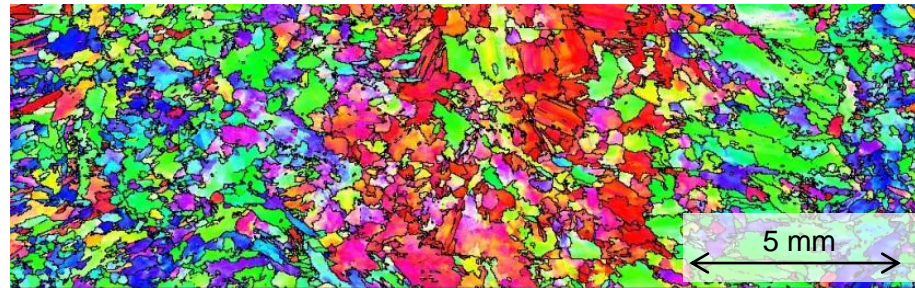

→ U-bends specimen in hydrogenated steam

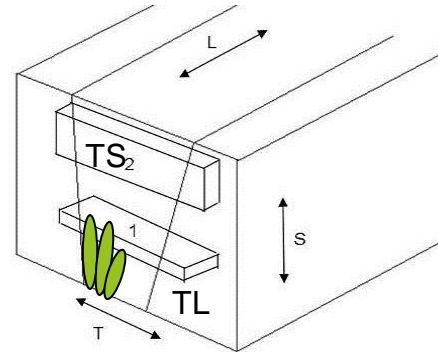

dendrites

- Hydrogenated steam :

Temperature	400 °C
Total pressure	188 bar
Hydrogen partial pressure	0.7 bar

- Strain fields are measured using gold grids and Digital Image Correlation.

- Direct loading path or complex loading path:

0 % → +12%

0% → -2% → +12%

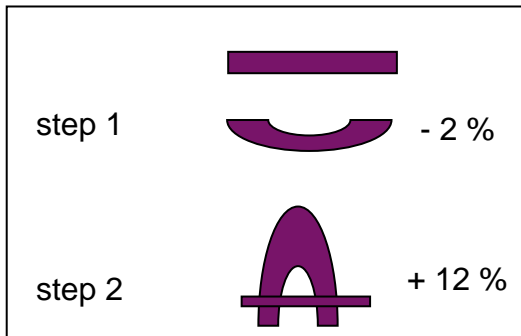

- Test time :
500 hr, 1500 hr, 2500 hr
and 3500 hr.

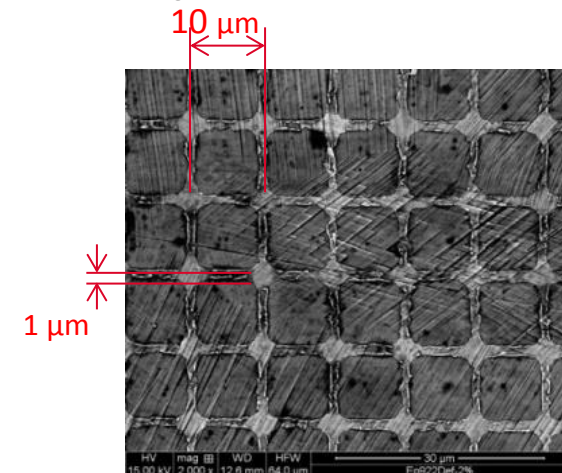

✓ SCC susceptibility.

- ✓ No crack after 500 hr in hydrogenated steam at 400°C.
- ✓ First cracks are observed after 1500 hr for the as-welded alloy and after 2500 hr for the heat-treated alloy (only one shallow crack).
- ✓ Cracks are intergranular.
- ✓ Cracks are observed inside and outside gold grids (used for DIC and strain field measurements) : the cracks are not induced by the grids.
- ✓ Most of the cracks are perpendicular to the loading direction.

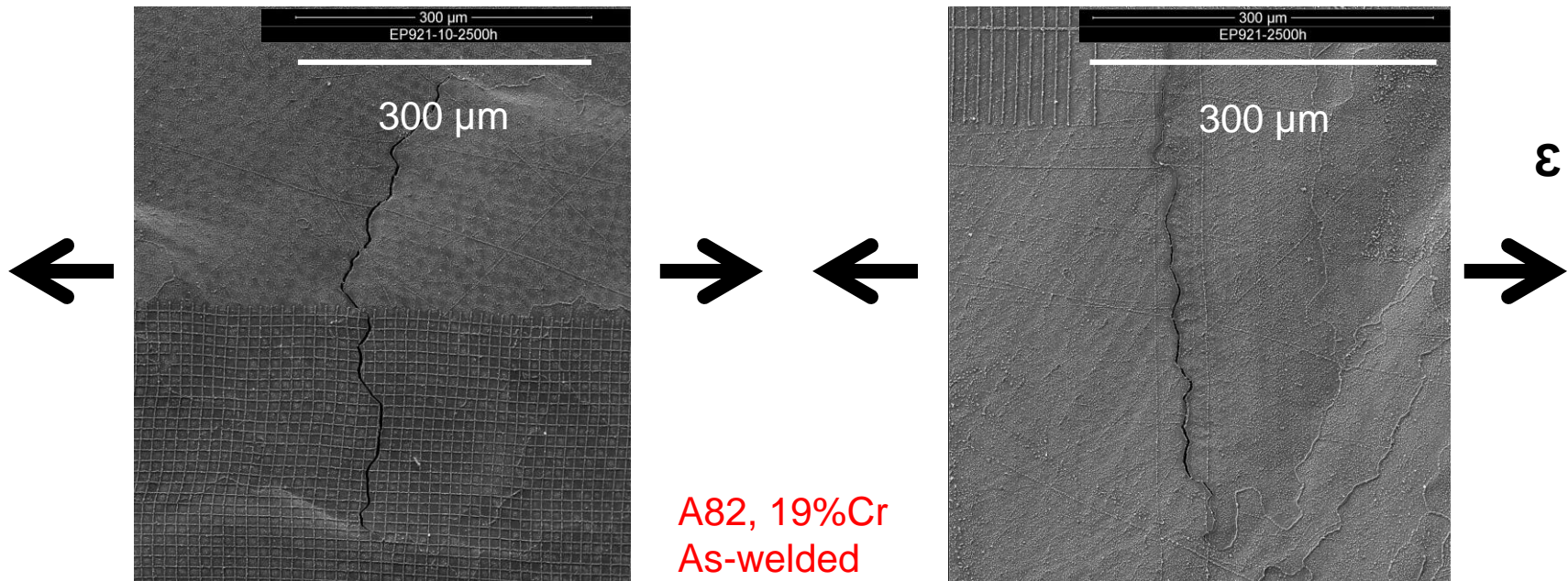

INITIATION TEST : RESULTS

Number of cracks / number of perpendicular grain boundaries

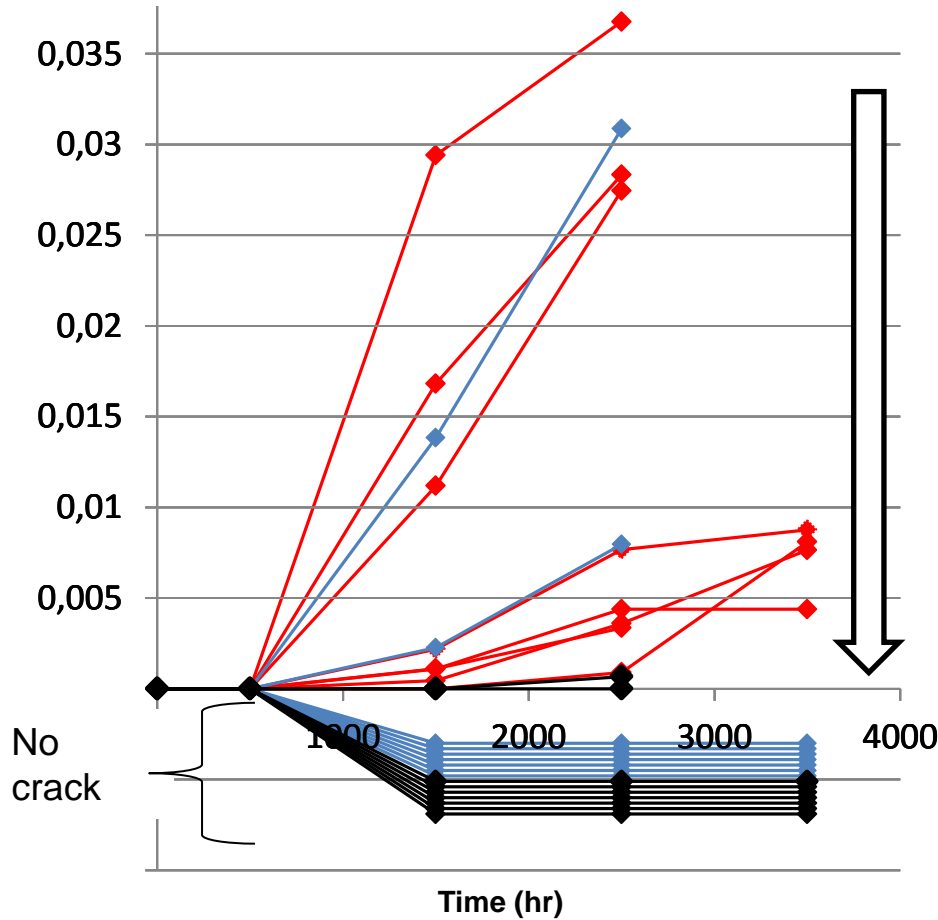

- Alloy A : A82 19%Cr, GTAW, as-welded
- Alloy A : A82 19%Cr, GTAW, heat-treated
- Alloy B : A82 18%Cr, FCAW, as-welded

The number of cracks increases with time.

Alloy A (AW) is less susceptible than Alloy B (AW).

Alloy A (HT) is less susceptible than Alloy A (AW).

Number of cracked specimen.

8 specimen were removed.

Time (hr)	500	1500	2500	3500
Alloy A AW	0/7	2/7	2/7	0/5
Alloy A AW	0/2	0/2	0/2	0/2
Alloy A HT	0/7	0/7	1/7	0/5
Alloy A HT	0/2	0/2	0/2	0/2
Alloy B AW	0/6	5/6	6/6	2/2
Alloy B AW	0/2	2/2	2/2	2/2

INFLUENCE OF THE MICROSTRUCTURE

Alloy A : A82, 19%Cr GTAW, as-welded

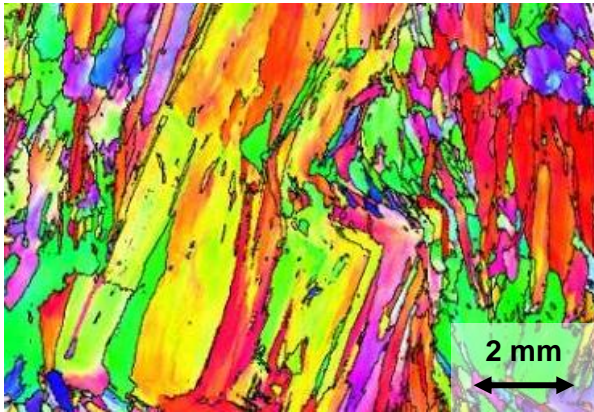

Direction de sollicitation
←→

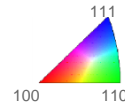

IPF
colouring
along the Y
axis

Alloy B: A82, 18%Cr FCAW, as-welded

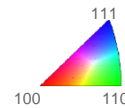
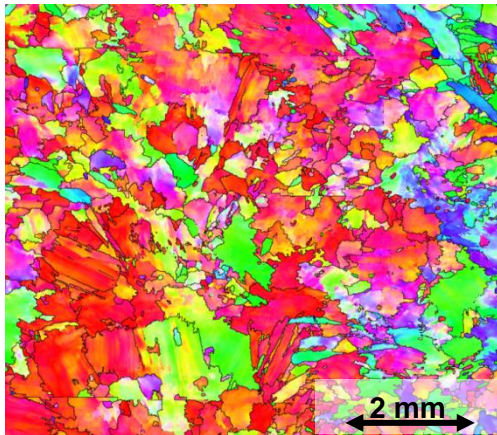
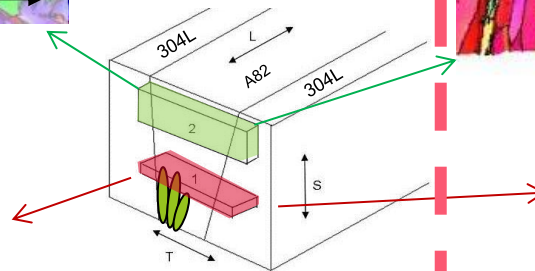

IPF
colouring
along the Z
axis

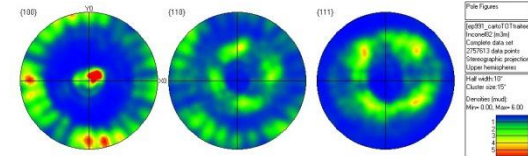
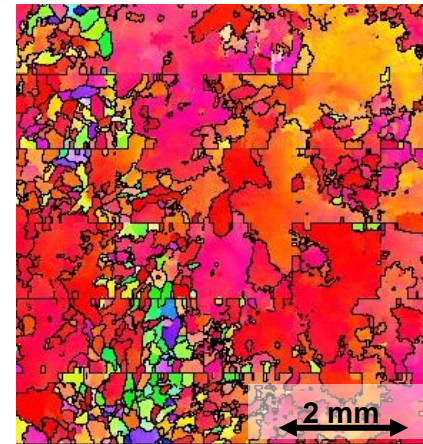

Alloy A : A82, 19%Cr GTAW, as-welded

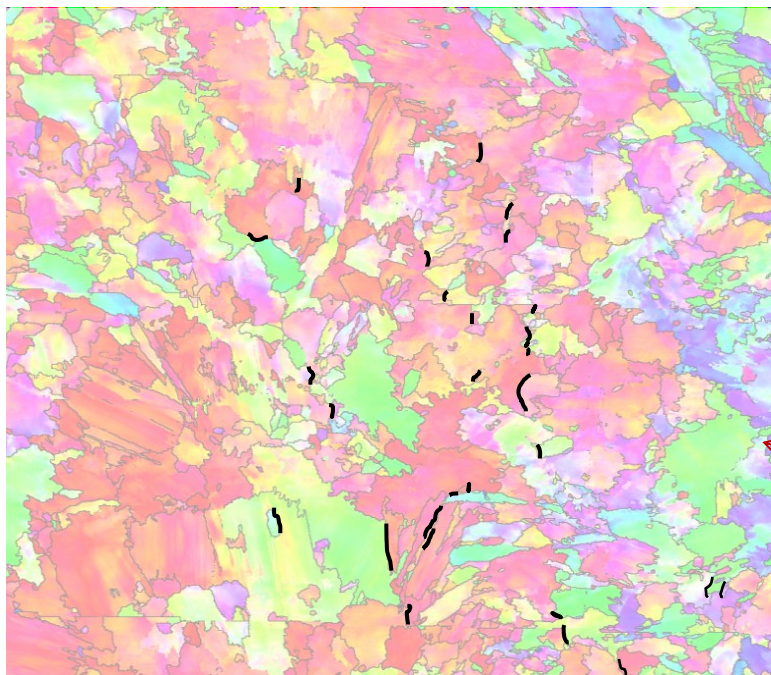

Alloy B: A82, 18%Cr FCAW, as-welded

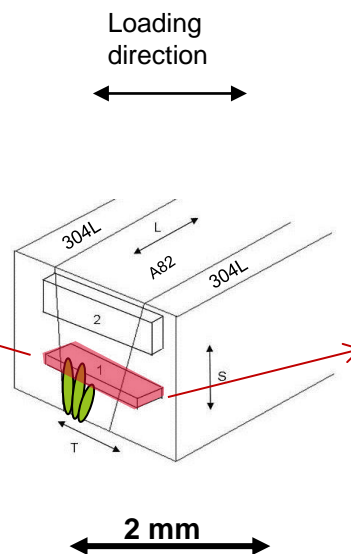
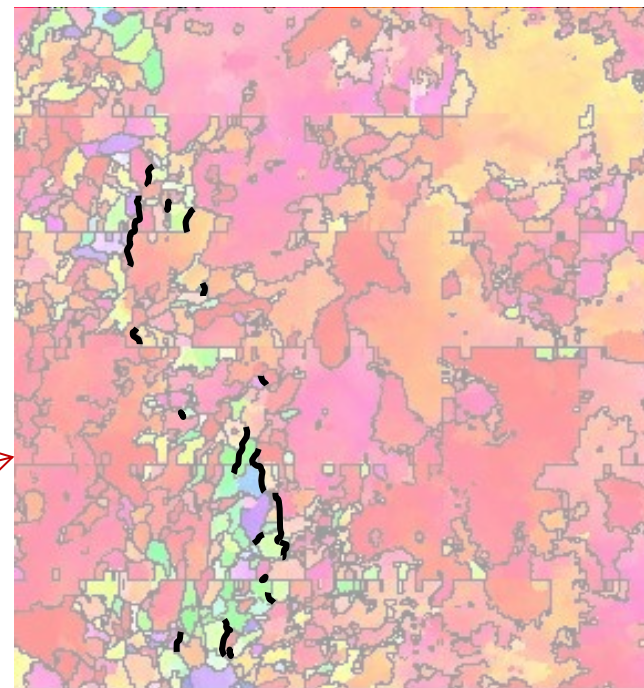

→ Cracks on **random grain boundaries**.

→ **No preferred grain orientation** next to cracked GB.

→ Most of the cracked GB are located **in zones containing small grains** (roots of the weld passes) : no segregation has been observed (SIMS, electron probe microanalyser).

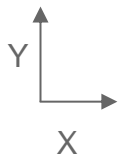
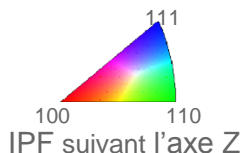

Alloy A : A82, 19%Cr GTAW, as-welded

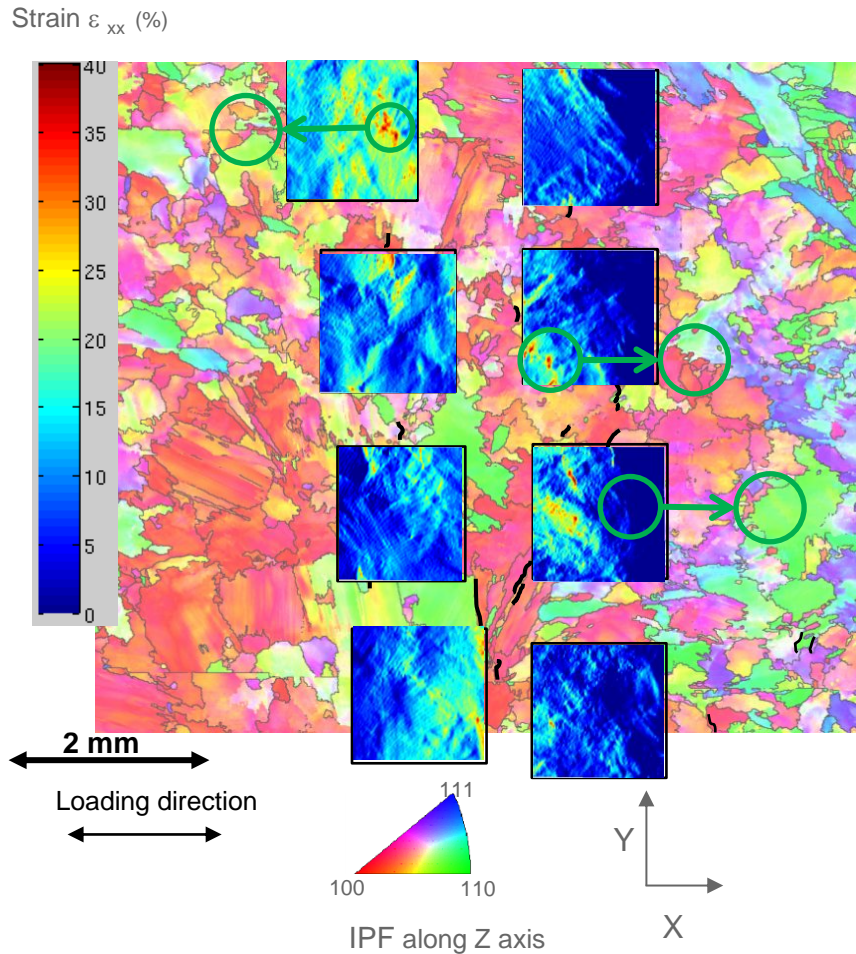

Average Von Mises strain for each grid

	16 %	5,2 %	
	10,4 %	4,6 %	
	8 %	5,4 %	
	11 %	4,8 %	

- Heterogeneous strain fields are measured by digital image correlation.
- No direct correlation between strain localization and crack initiation¹.
- **Finite element simulations** have been carried out in order to determine normal **stress fields** along cracked and uncracked grain boundaries.

→ Simulation of stress fields by finite elements are performed on bicrystals simulating one GB in the case of 16 cracked grain boundaries and 13 uncracked grain boundaries.

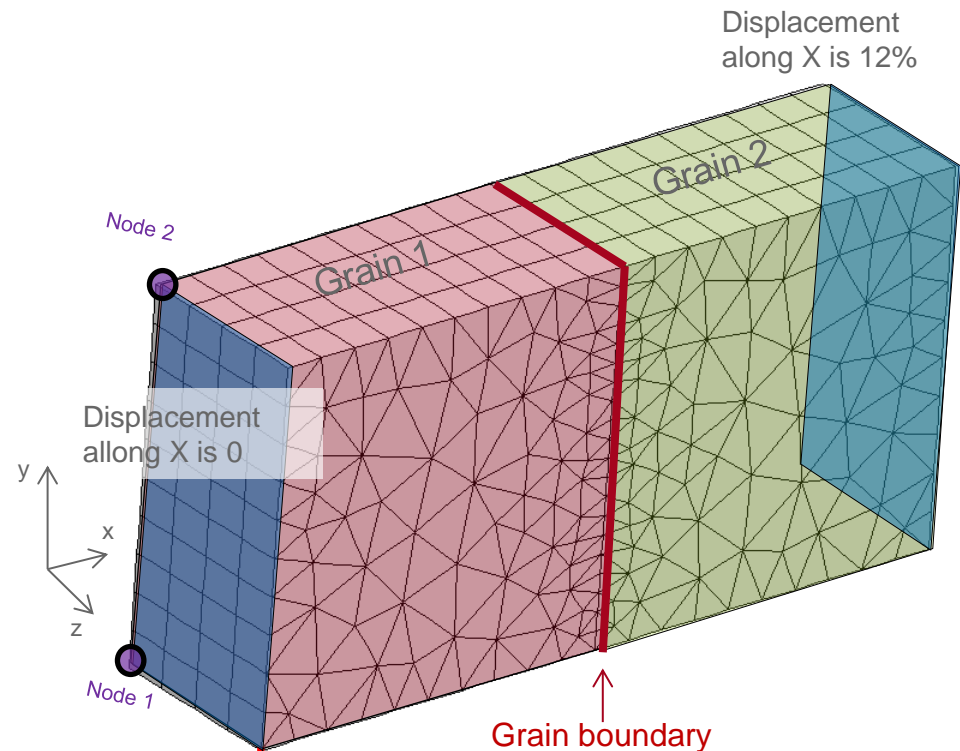

→ Crystallographic orientations are extracted from the EBSD characterizations.

→ Crystallographic law (octaedic elasto-viscoplastic law)¹

$$\dot{\gamma} = \left\langle \frac{(\sigma - X) - R}{K} \right\rangle^n$$

$\dot{\gamma}$: shear rate

σ : critical resolved shear stress

X : kinematic hardening

R : isotropic hardening

K and n : Norton law's parameters

→ Boundary conditions :
a displacement along X is applied

→ First step : a macroscopic deformation of 12 % is applied on true crystallographic orientations.

→ Results : maximum normal stress

Max stress (Sigma XX) normalized by the mean stress in the grains.

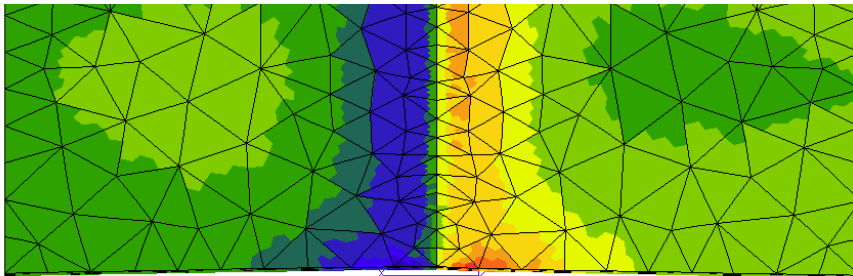
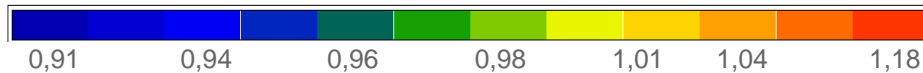

→ Stress localisation close to the grain boundary in all cases (cracked and uncracked GB).

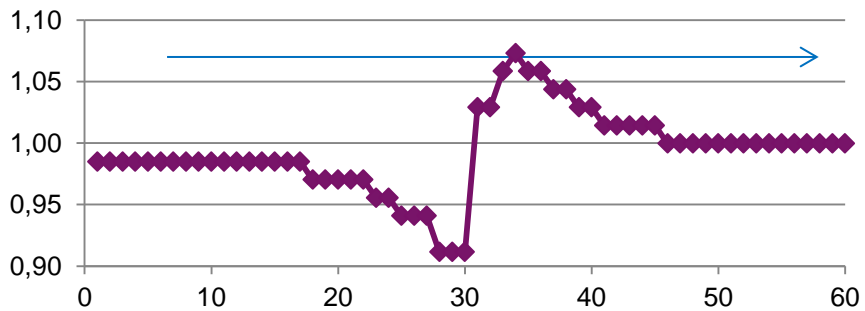

→ Comparison between cracked and uncracked grain boundaries.

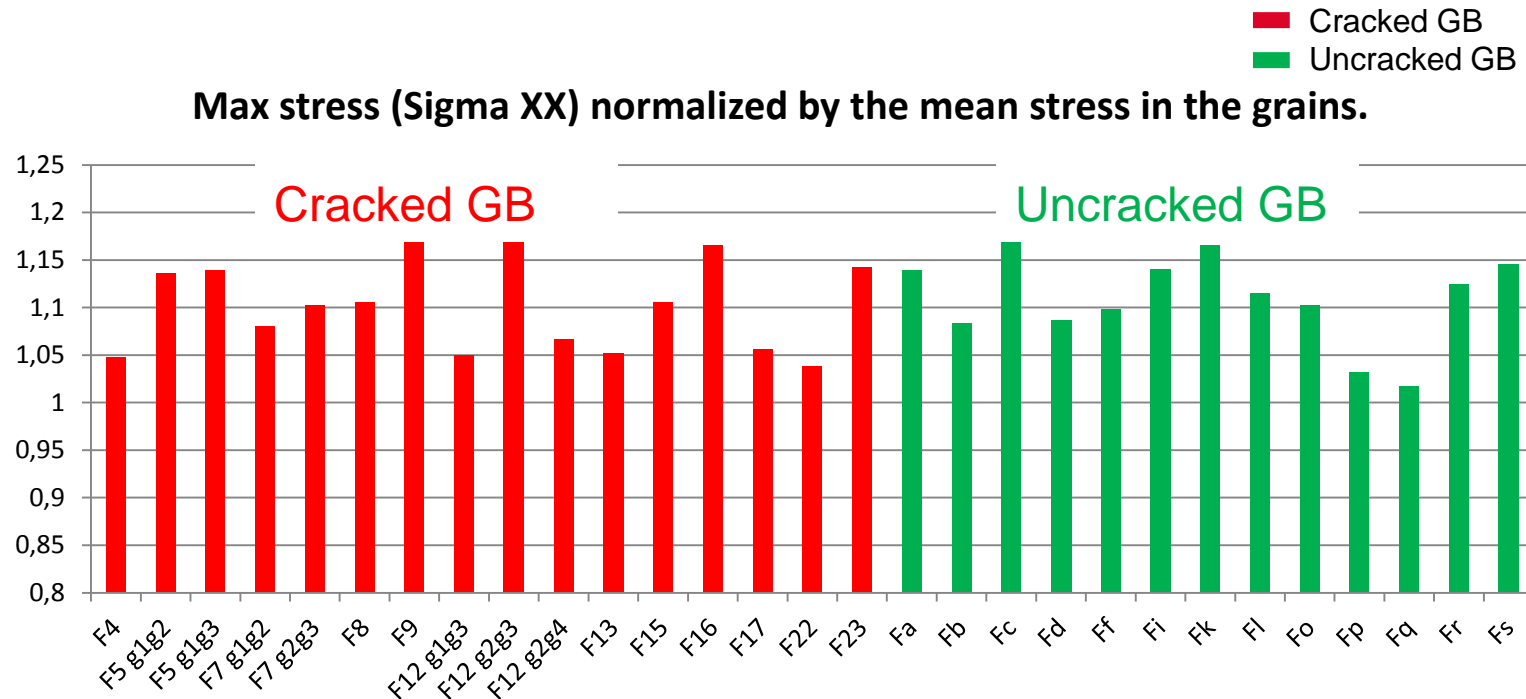

→ The stress is not systematically higher for cracked grain boundaries.

→ The **strain field** (measured by DIC) should also be used **as a boundary condition** : both experimental crystallographic orientation and strain fields -> is the maximum normal stress a criteria to predict cracked GB ?

- SCC initiation test:
 - **Alloy 82 is susceptible to SCC** initiation in hydrogenated steam at 400°C : first cracks are observed **after 1500 hr.**
 - The **thermal treatment** (similar to the in-service stress relief treatment) can decrease the susceptibility to SCC. In this study, it is probably due to the **formation of intergranular chromium carbides.**
 - As – welded Alloy B is more susceptible to SCC than as-welded Alloy A : not the same chemical composition and not the same crystallographic texture (welding process is different). No IG chromium carbides for both alloys.

- Correlations between microstructure / strain fields and SCC :
 - **Crystallographic orientations and strain localization are not sufficient parameters to predict susceptible grain boundaries.**
 - Most of the cracks are located **in zones with the smallest grains** (roots of the weld passes) **-> chemical analysis are in progress**

- Future **FE simulations** will take into account **both the strain fields measured by digital image correlation and the crystallographic orientations** : critical normal stress to discriminate between cracked and uncracked GB ?

- *Which one of those parameters will be at the first order of magnitude ?*