



HAL
open science

Biases ans uncertainties in Doppler reactivity worth calculations

A. Santamarina, D. Bernard

► **To cite this version:**

A. Santamarina, D. Bernard. Biases ans uncertainties in Doppler reactivity worth calculations. UAM-9 Workshop - Workshop on Uncertainty Analysis in Modeling, May 2015, Madrid, Spain. cea-02492562

HAL Id: cea-02492562

<https://cea.hal.science/cea-02492562>

Submitted on 27 Feb 2020

HAL is a multi-disciplinary open access archive for the deposit and dissemination of scientific research documents, whether they are published or not. The documents may come from teaching and research institutions in France or abroad, or from public or private research centers.

L'archive ouverte pluridisciplinaire **HAL**, est destinée au dépôt et à la diffusion de documents scientifiques de niveau recherche, publiés ou non, émanant des établissements d'enseignement et de recherche français ou étrangers, des laboratoires publics ou privés.

DE LA RECHERCHE À L'INDUSTRIE

cea den

Biases and Uncertainties in Doppler reactivity worth calculations

UAM-9 Workshop

20-22 May 2015

A. Santamarina, D. Bernard

➤ **The Fuel Reactivity Temperature Coefficient**

➤ **Challenges and biases in Doppler deterministic calculations**

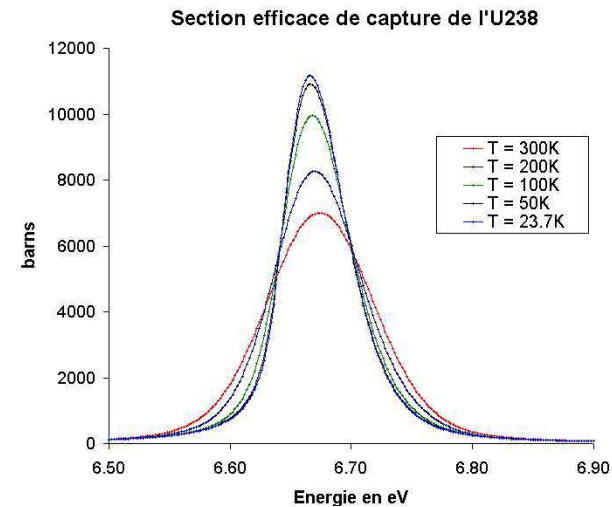

➤ **Uniform effective temperature T_{eff} to account for pellet Temperature profile**

➤ **Effective temperature T_{eff}^{RI} to account for Crystal Lattice binding in UO₂ fuel**

➤ **Up-scattering effect in resonances**

➤ **Recommendations and Conclusion : Uncertainty in standard Doppler calculations**

The Fuel Reactivity Temperature Coefficient (FTC)

- 90% of the Fuel Temperature reactivity worth is due to $^{238}\text{U}(n,\gamma)$ broadening
 - ^{235}U component is weak (0.1%), due to cancellation of (n,f) and (n, γ) contributions
 - $^{16}\text{O}(n,n)$ positive component amounts to 10 % (thermal spectrum shift effect).
-
- 35% of $^{238}\text{U}(n,\gamma)$ Doppler effect comes from the first 3 resonances broadening.
 - 60% of $^{238}\text{U}(n,\gamma)$ Doppler effect comes from $E_n = [60\text{eV}; 2\text{keV}]$, unless capture rate is only 20%

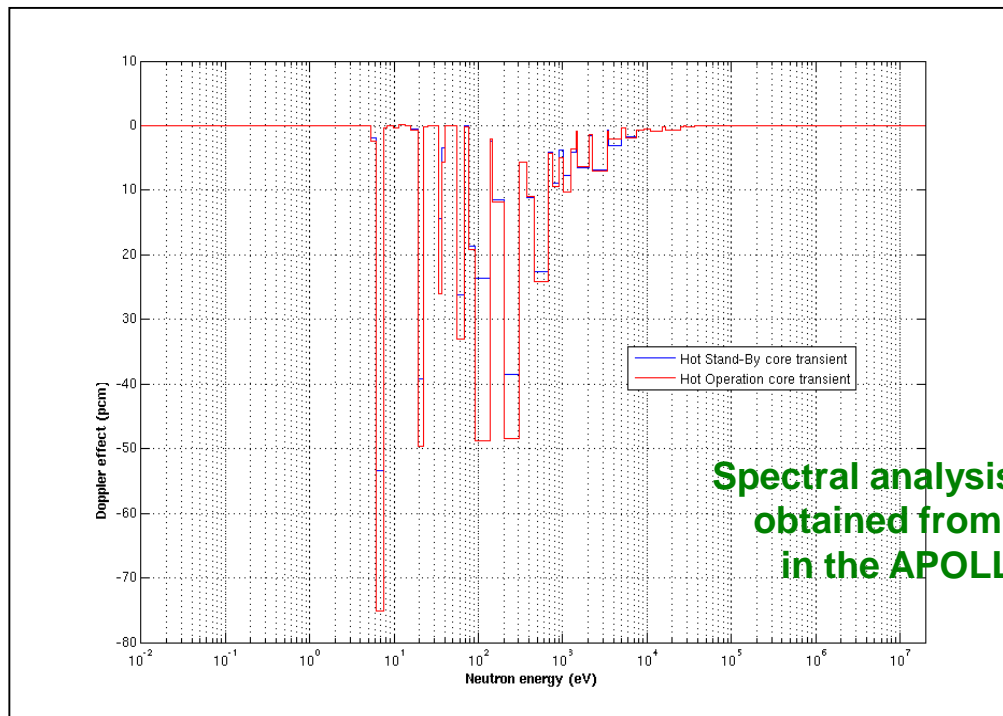

Spectral analysis of ^{238}U Doppler worth
obtained from Perturbation Theory
in the APOLLO2 transport code

- The Fuel Reactivity Temperature Coefficient
- **Challenges and biases in Doppler deterministic calculations**
- Uniform effective temperature T_{eff} to account for pellet temperature profile
- Effective temperature T_{eff}^{RI} to account for Crystal Lattice binding in UO₂ fuel
- Up-scattering effect in resonances
- **Recommendations and Conclusion : Uncertainty in standard Doppler calculations**

Spatial self-shielding

- Resonance energetic self-shielding comes with fuel rod spatial self-shielding
- ^{238}U resonances are more self-shielded at the center of fuel pellet (shadow effect)
 \Rightarrow ^{238}U capture and ^{239}Pu build-up is higher on pellet boundary \Rightarrow thermomechanic 'rim effect' (Bu is twice !)

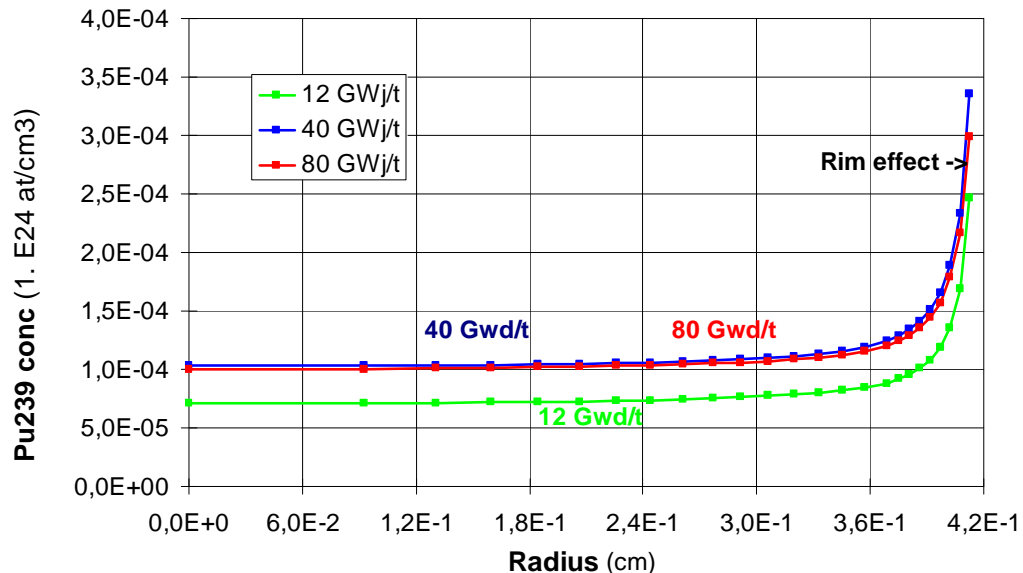

Fuel :
4 'self-shielded regions' needed

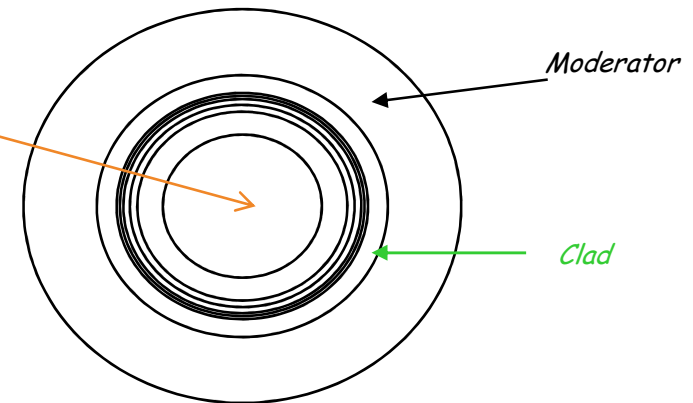

- Space-dependent self-shielding is required for accurate LWR calc.
- **4 concentric rings :**
5%, 15%, 30%, 50% in volume

Exact Perturbation Theory supplies the following spatial informations:

- 60% of the $^{238}\text{U}(n,\gamma)$ Doppler effect comes from the first 800 μm of the pellet
- The rim effect is significant in the Doppler worth:
both $\tau^{238}\text{U}(n,\gamma)$ and $\Delta\tau^{238}\text{U}(n,\gamma)$ present a non-uniform spatial distribution

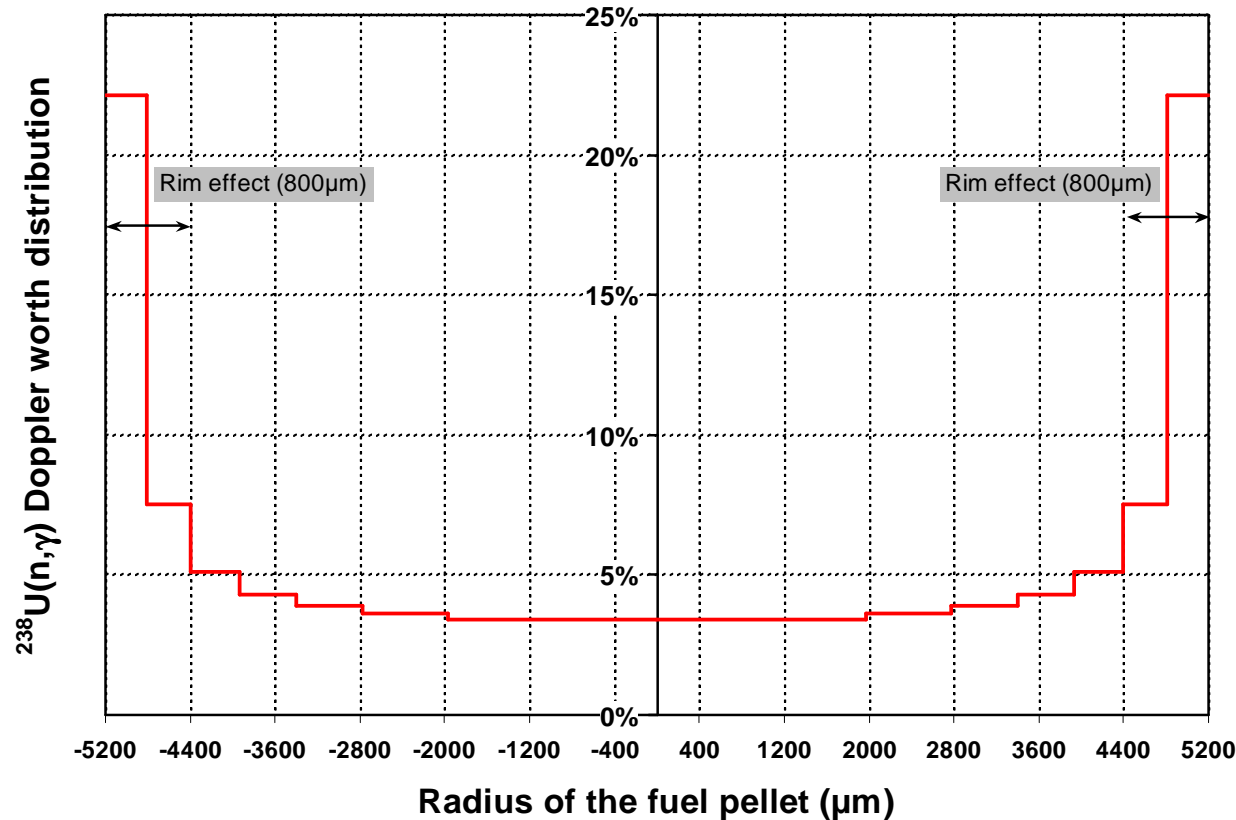

Thus, the temperature model have to take into account the actual surface temperature.

FTC components in LWR UO2 assemblies

Isotopic components obtained from Perturbation Theory : $\delta\rho = \frac{1}{I_f} \langle \phi^*, \delta H \phi \rangle$

The Rim effect induces 30% Doppler contribution for the 5% pellet periphery
 ⇒ temperature at fuel surface should be accounted for

UOX fuel	Fuel region 1	Fuel region 2	Fuel region 3	Fuel region 4	Full Fuel
²³⁸ U	-42.9	-36.2	-38.2	-29.4	-146.7
²³⁵ U	+0.1	0.0	0.0	0.0	+0.1
¹⁶ O					+12.9
Total	-42.8	-36.2	-38.2	-29.4	-133.7

Thermal spectrum shift due to temperature of fuel's Oxygen

(n,γ)	(n,f)	(n,n)	$\sigma_s^{g' \rightarrow g}$	Total
-148.2	+0.6	+1.5	+12.4	-133.7

1st calculation challenge : space-dependent self-shielding formalisms require crossed probability tables to account for non-uniform temperatures

FTC components in LWR MOX assemblies

- ^{238}U broadened resonance contribution almost the same in MOx and UOx fuels
- **Doppler level increases by about 30% due to ^{240}Pu broadening**

MOX Sample	Fuel region 1	Fuel region 2	Fuel region 3	Fuel region 4	Full Fuel
^{238}U	-42.9	-36.1	-42.1	-31.7	-152.8
^{240}Pu	-23.2	-22.8	-19.0	-6.6	-71.6
^{239}Pu	-0.6	-0.2	-0.1	0.0	-0.9
^{242}Pu	-0.5	-0.3	-0.1	0.0	-0.9
^{241}Pu	+0.1	+0.1	0.0	0.0	+0.2
^{235}U	+0.1	0.0	0.0	0.0	+0.1
^{16}O					-6.6
Total	-67.0	-59.3	-61.3	-38.3	-232.5

^{239}Pu : cancellation between (n,f) and (n, γ) strong components

Thermal spectrum shift due to temperature of fuel's Oxygen : becomes negative

(n, γ)	(n,f)	(n,n)	$\sigma_s^{g' \rightarrow g}$	Total
-272.9	+42.4	+4.6	-6.6	-232.5

Resonance overlap in MOX: 2nd Doppler calc challenge

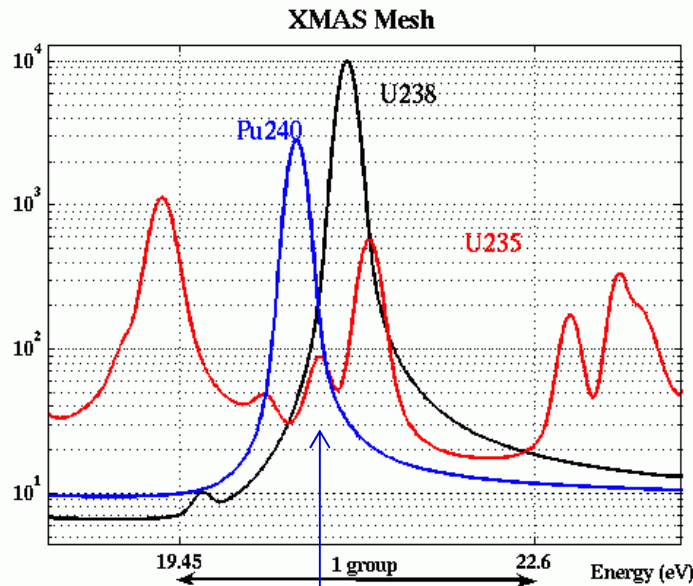

$^{238}\text{U}/^{240}\text{Pu}/^{235}\text{U}$ overlap at $E=20\text{eV}$

Mutual shielding taken into account by the fine mesh of SHEM

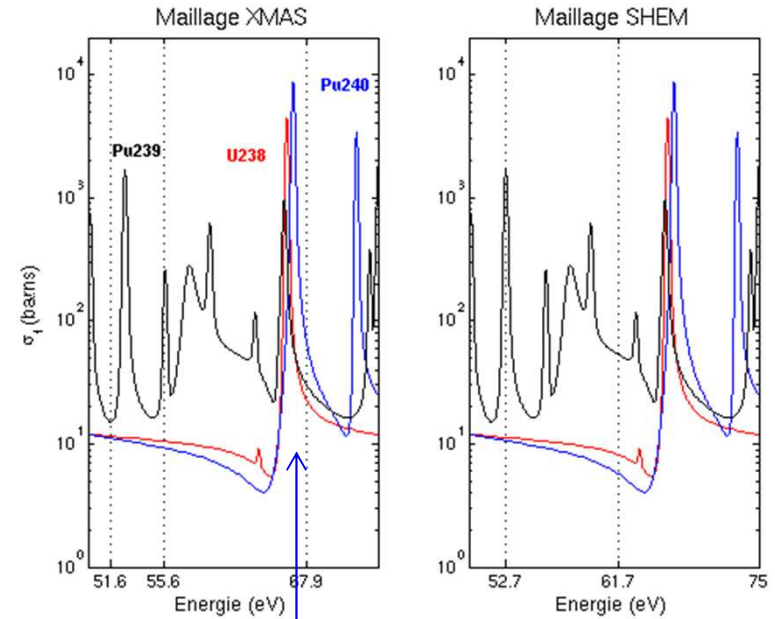

$^{238}\text{U}/^{240}\text{Pu}/^{239}\text{Pu}$ overlap at $E=66\text{eV}$

Mutual shielding taken into account by SHEM-361g (used for Sub-Group method)

D. Bernard - A. Santamarina, Conf. M&C2003, Gatlinburg, April 6-11

Rigorous method:
iterative algorithm for optimal discretisation

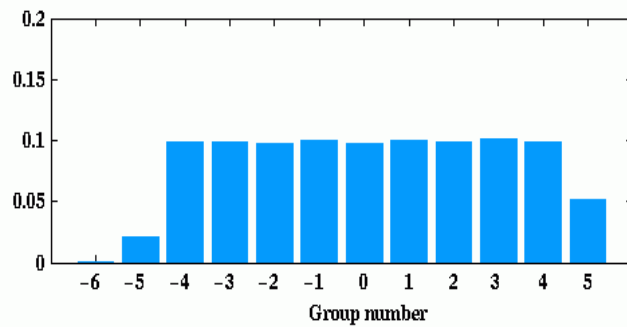
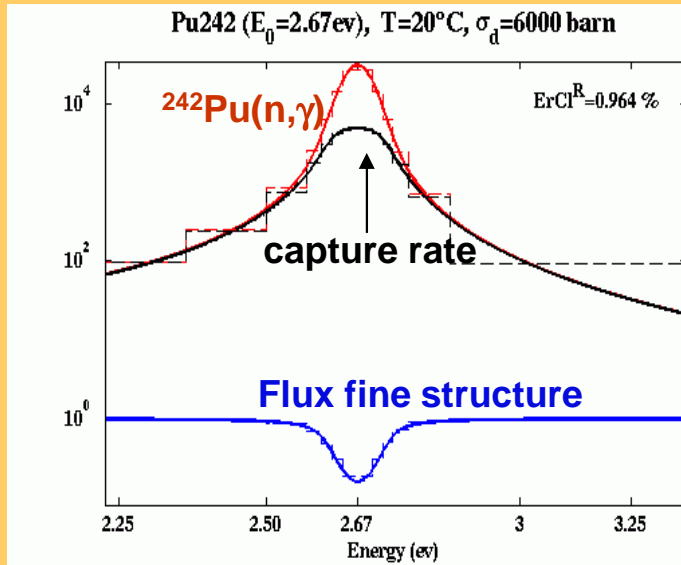

U238/U235 overlap 20eV

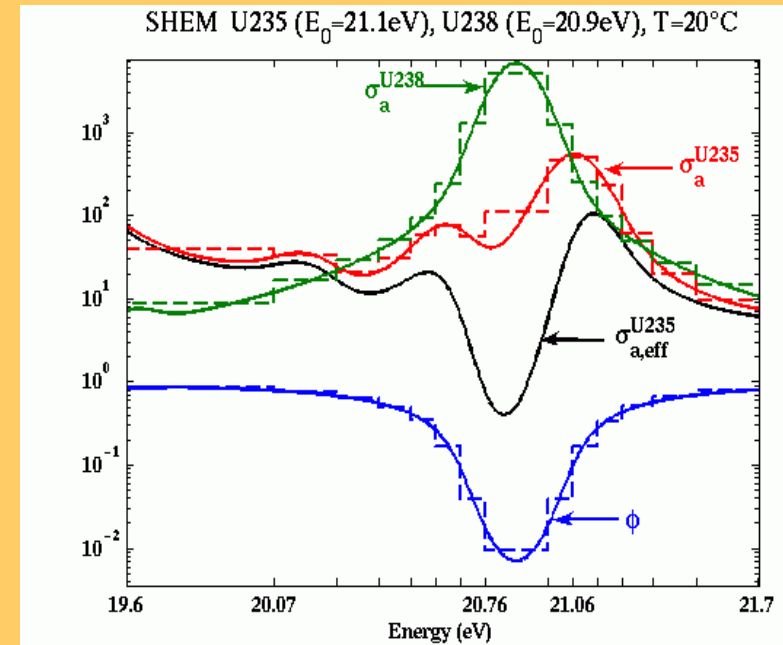

N. Hfaiedh - A. Santamarina, Conf. M&C2005, Avignon, Sept 12-15

SHEM-361g for Sub-Group self-shielding

- From SHEM-281g to SHEM-361g to allow NR assumption in SG method
⇒ refine discretization between 24eV and 3keV → 80 supplementary groups

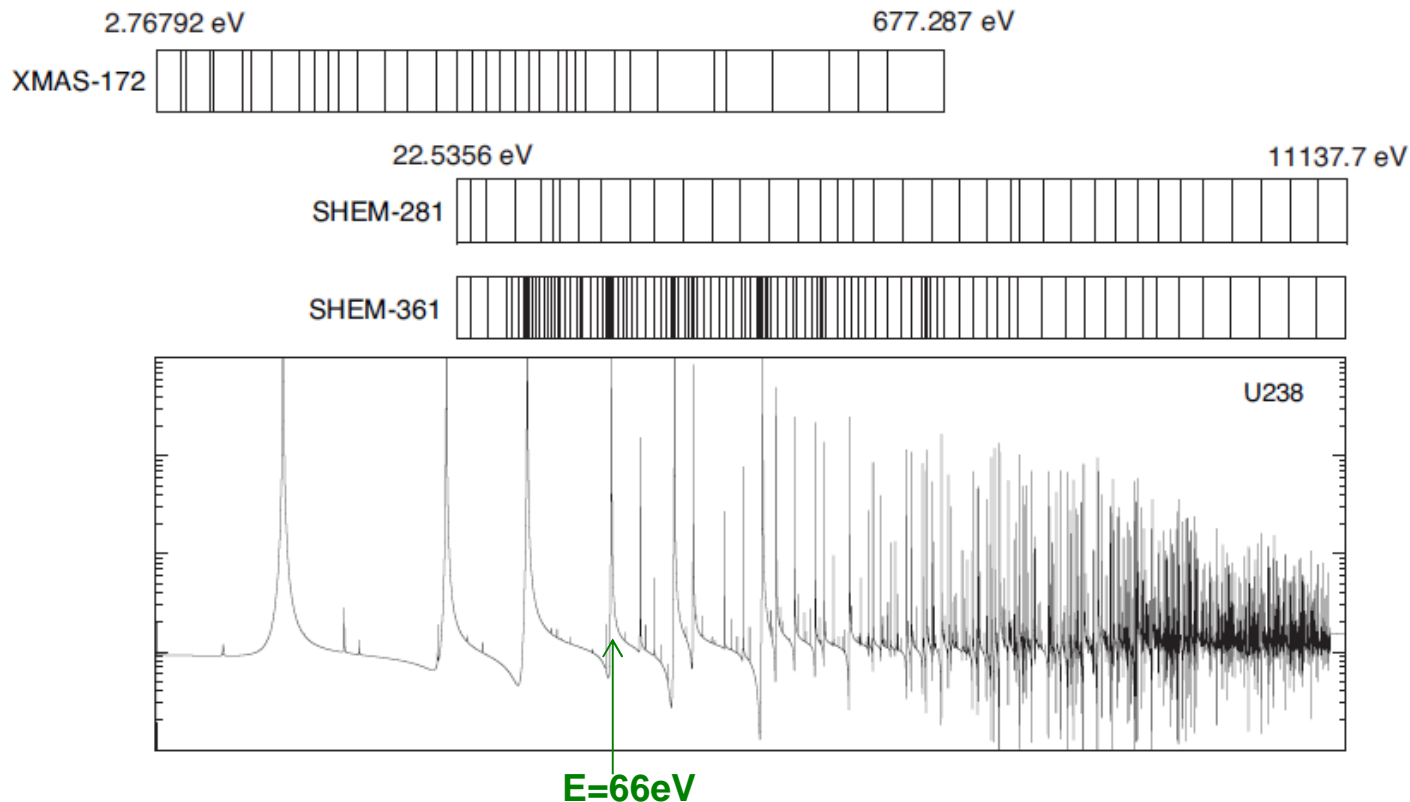

- Moreover, resonance overlap ^{238}U / ^{239}Pu is explicitly described

- The Fuel Reactivity Temperature Coefficient
- Challenges and biases in Doppler deterministic calculations
- **Uniform effective temperature T_{eff} to account for pellet temperature profile**
- Effective temperature T_{eff}^{RI} to account for Crystal Lattice binding in UO₂ fuel
- Up-scattering effect in resonances
- Recommendations and Conclusion : **Uncertainty in standard Doppler calculations**

Spectral distribution of the ^{238}U capture increase with fuel temperature

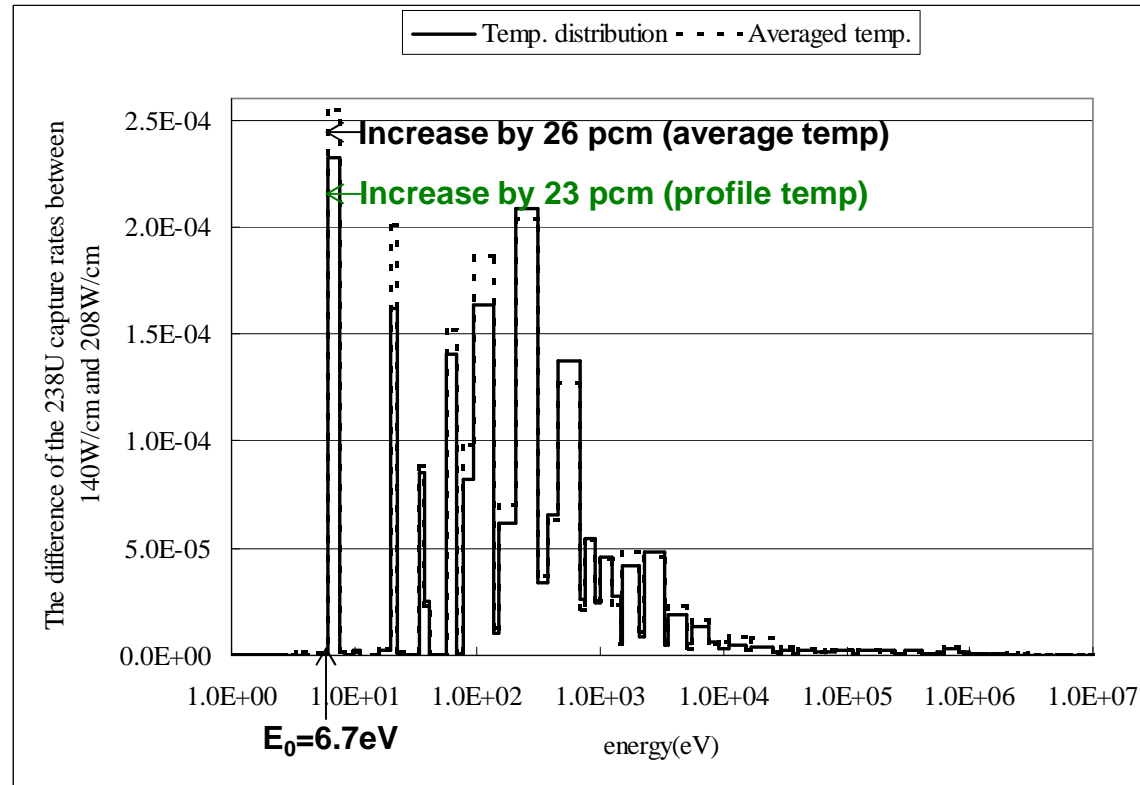

The average temperature model overestimates the ^{238}U capture increase particularly in the first large resonances (because true temperature is lower in the rim)

Consideration of temperature profile (cylindrical pellet)

- At least, Rowlands formula should be used :

$$T_{eff} = \frac{4}{9}T_c + \frac{5}{9}T_s$$

- We propose the more accurate effective temperature (also suited for transients):

$$T_{eff} = \bar{T}_{therm} - \frac{1}{18}(T_c - T_s)$$

with: $\bar{T}^{therm} = \int T(r) dr / \int dr$

A. Santamarina, Report CEA/SPRC/02-03, 2002

- The Fuel Reactivity Temperature Coefficient
- Challenges and biases in Doppler deterministic calculations
- Uniform effective temperature T_{eff} to account for pellet temperature profile
- **Effective temperature T_{eff}^{RI} to account for Crystal Lattice binding in UO₂ fuel**
- Up-scattering effect in resonances
- Recommendations and Conclusion : Uncertainty in standard Doppler calculations

Doppler broadening of ^{238}U in UO_2 fuels

Gelina meas. of resonance $E^{U^{238}}=6.7\text{eV}$

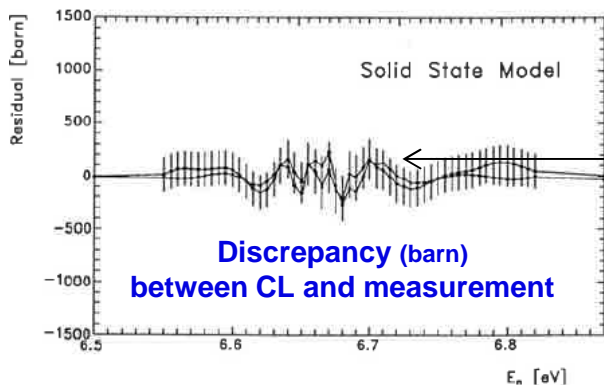
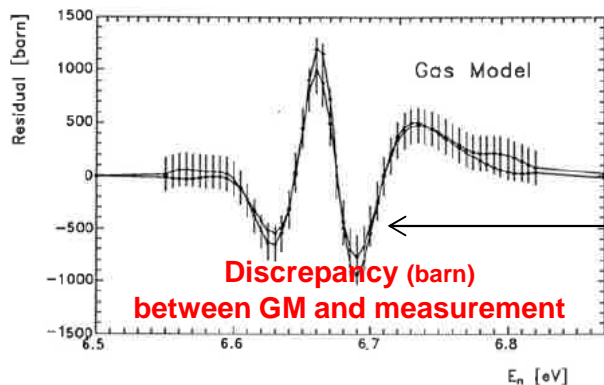
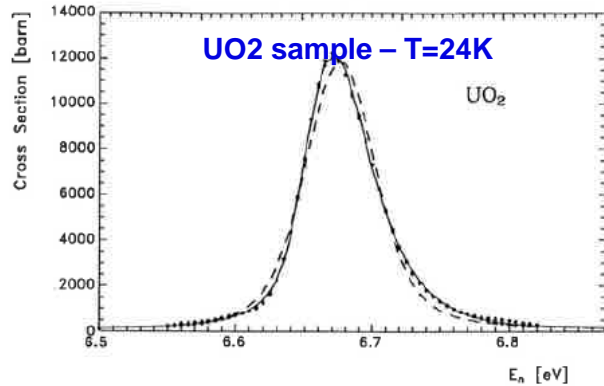

- Thermal motion of fuel atoms → Free Gas Model (GM)
- **But** atoms are actually embedded in a solid state
- Lamb has shown that in a 'weak binding' assumption, the Doppler broadening can be approximated by GM, using an effective temperature $T_{\text{eff}}^L (= \langle \mathcal{E} \rangle / k_B)$
- The 'weak binding' approx is not relevant for $E_n < 1\text{keV}$
 ⇒ **GM using T_{eff}^L does not fit ^{238}U first resonances**
- We use **Cristal Lattice Model(LM)**, with 2 lattice vibration frequencies (acoustic and optical mode):

$$\rho(\hbar\omega) = 0.9 \cdot \delta(\hbar\omega - 13.4\text{meV}) + 0.1 \cdot \delta(\hbar\omega - 51.8\text{meV})$$
 ⇒ **describe accurately ^{238}U resonances in UO_2**

A. Meister et al., Conf. ND'97, Trieste, May 19-24

Determination of the actual effective temperature

- The real effective temp $T_{\text{eff}}^{\text{RI}}$ has to preserve the ^{238}U capture rate (thus I_{eff} Res. Integral)
- Solving the flux fine structure equation (both for σ_{238}^{GM} and σ_{238}^{LM}) supplies I_{eff}
- Then we solved the following equation : $I_{\text{eff}}^{\text{GM}}(T_{\text{eff}}^{\text{RI}}) = I_{\text{eff}}^{\text{LM}}(T)$

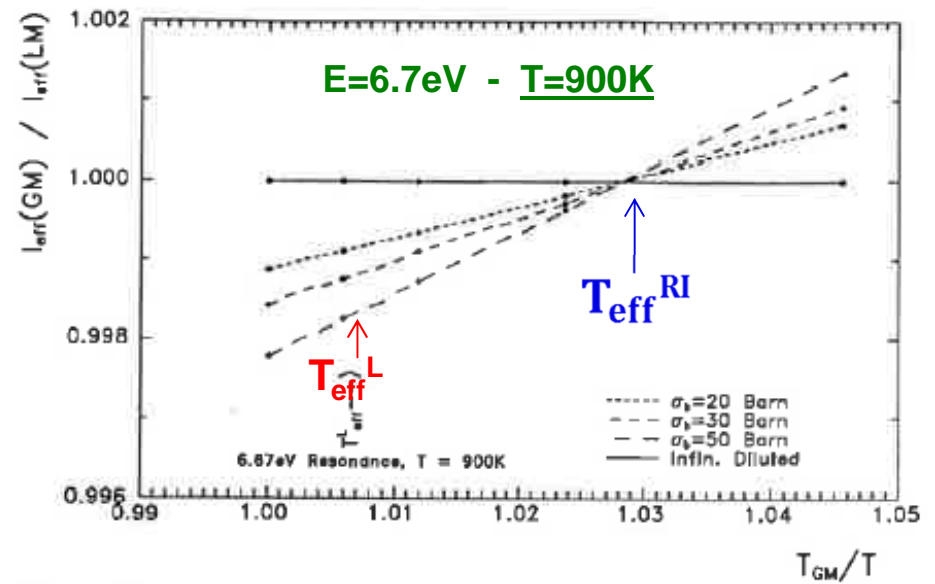
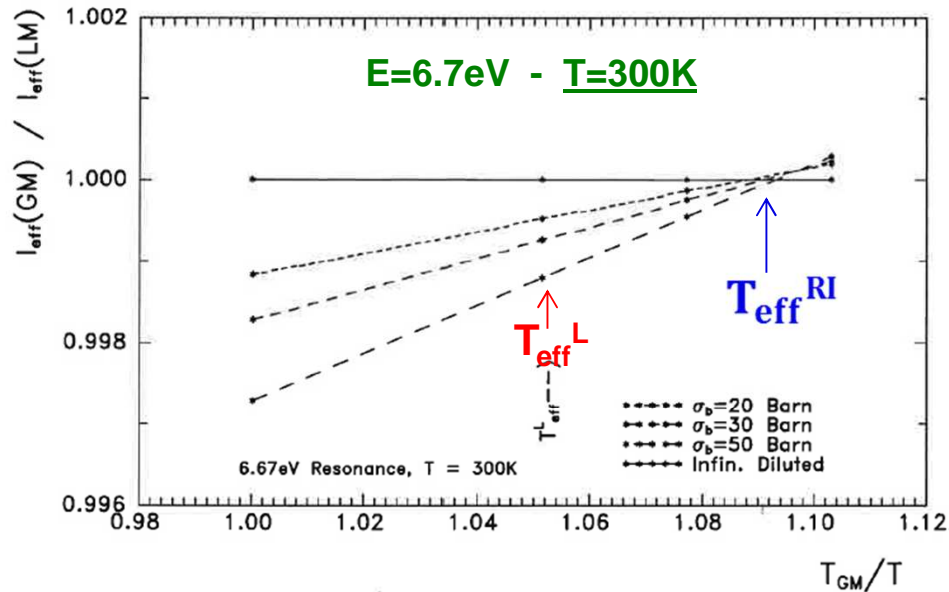

- $T_{\text{eff}}^{\text{RI}}$ is quite independent from Geometry/Concentration

A. Meister and A. Santamarina, Conf. PHYSOR98, Long Island, May 19-24

The accurate effective temperature $T_{\text{eff}}^{\text{RI}}$

- $T_{\text{eff}}^{\text{RI}}$ depends strongly on resonance energy:
 - In large resonances $E < 100$ eV, the solid state effect is stronger than Lamb ($T_{\text{eff}}^{\text{RI}} > T_{\text{eff}}^{\text{L}}$)
 - Above 1 keV, $T_{\text{eff}}^{\text{RI}}$ tends towards $T_{\text{eff}}^{\text{L}}$

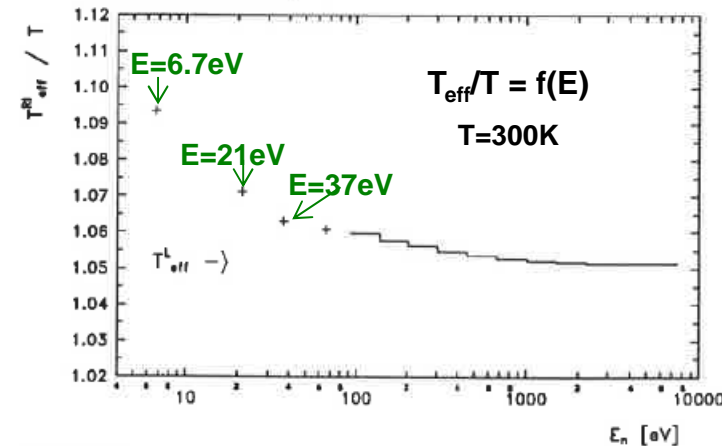

➤ Therefore we proposed $T_{\text{eff}}^{\text{RI}}/T$ corrections for the various energy domains

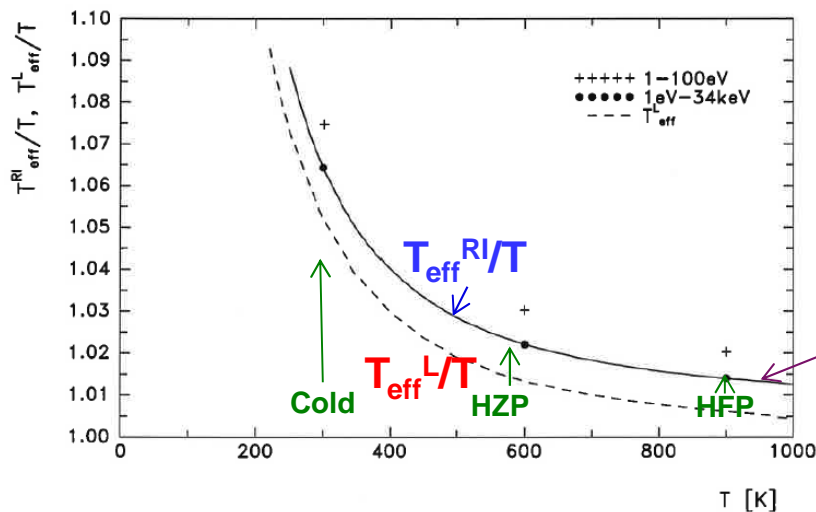

➤ However, the I_{eff} preservation on the whole resonance range (useful for **thermal reactors**) gives the **Meister-Santamarina formula** ($T < 1000\text{K}$):

$$\frac{T_{\text{eff}}}{T} = 1 + \frac{8.6}{T} + \frac{3100}{T^2} \quad (T \text{ en K})$$

- The Fuel Reactivity Temperature Coefficient
- Challenges and biases in Doppler deterministic calculations
- Uniform effective temperature T_{eff} to account for pellet temperature profile
- Effective temperature T_{eff}^{RI} to account for Crystal Lattice binding in UO₂ fuel
- **Up-scattering effect in resonances**
- Recommendations and Conclusion : Uncertainty in standard Doppler calculations

- **The Asymptotic Kernel (AK): T = 0K - target at rest**

$$P(E \rightarrow E') dE' = \frac{1}{(1-\alpha)E} dE' \quad \text{with} \quad \alpha = \left(\frac{A-1}{A+1} \right)^2$$

→ Used in deterministic resonance self shielding calculation

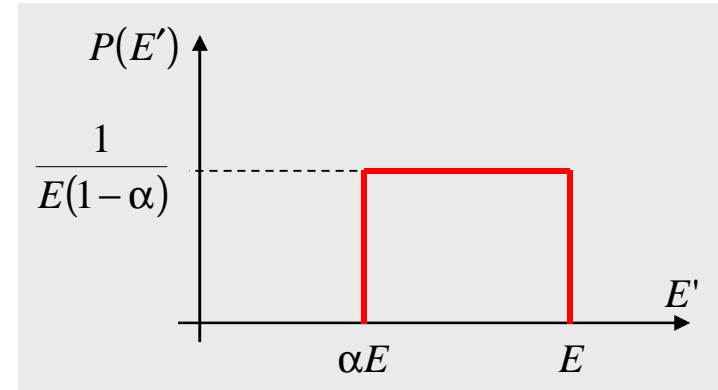

- **Sampling the Velocity of the Target (SVT) → Used in Monte Carlo codes**

$$\sigma_s(E \rightarrow E', \omega \rightarrow \omega', T) = \frac{1}{v} \int_{V: v_r > 0} v_r \sigma_s(v_r, 0) P(v, V \rightarrow E', \omega') M_T(V) dV$$

joint Probability Density: $p(V, \mu_t) = \frac{\sigma_s(v_r, 0) v_r g(V)}{2\sigma_s(E, T) v}$ $\sigma_s(v_r) = \text{constant}$ + $\Rightarrow p(V, \mu_t) \propto \frac{\sqrt{v^2 + V^2 - 2\mu_t V v}}{v + V} [V^3 e^{-\beta^2 V^2} + v V^2 e^{-\beta^2 v^2}]$
Gaz Model

SVT algorithm : μ uniformly sampled in [-1;+1] - target velocity V sampled - then Rejection applied to sampled pair (μ_i, V_i)

$$R_{SVT} = \frac{\sqrt{v^2 + V^2 - 2\mu_t V v}}{v + V} = \frac{v_r}{v + V} \leq 1$$

When (μ_i, V_i) known, the two-body kinematic equations for energy and momentum are solved \Rightarrow scattered neutron properties

Resonance Elastic Kernel and Up-scattering

- ▶ **Ouisloumen & Sanchez (NSE 1991)** : energy distribution of scattered neutrons at resonance energy is strongly affected by nuclei thermal motion
- ▶ **Bouland & Rowlands (Conf ND1994)** developed the TRAMP code and quantified resonant scattering effect. At LWR HZP:
 - +1% on ^{238}U capture rate
 - +9% on Doppler coefficient
- ▶ **A. Courcelle, R. Dagan, J. Rowlands** tried to consider **solid state effects on resonance scattering** : small impact vs GM

Dagan, Rowlands, Courcelle (Conf ND2007, Nice)

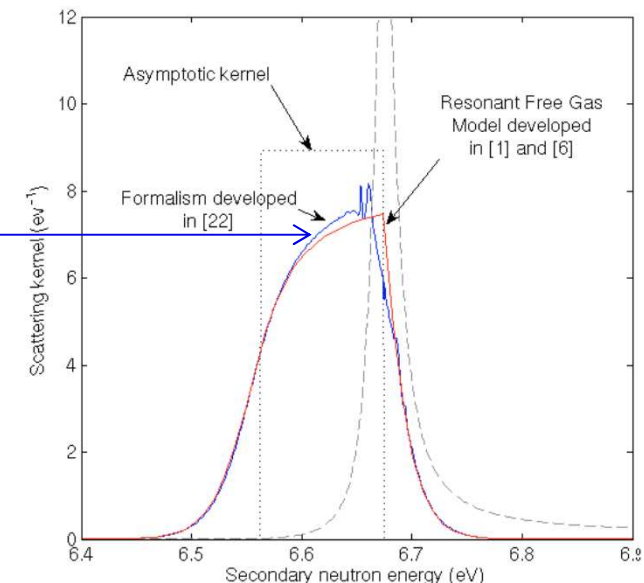
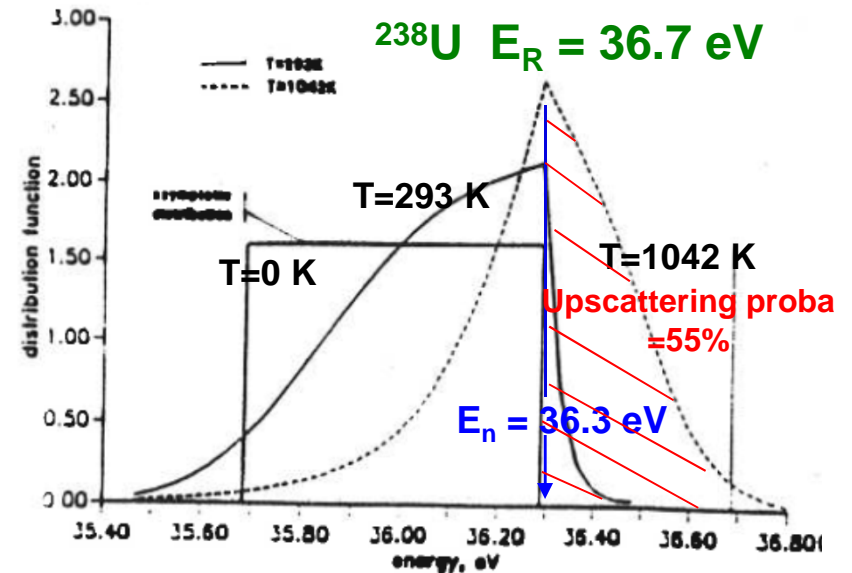

- The Fuel Reactivity Temperature Coefficient
- Challenges and biases in Doppler deterministic calculations
- Uniform effective temperature T_{eff} to account for pellet temperature profile
- Effective temperature T_{eff}^{CL} to account for Crystal Lattice binding in UO₂ fuel
- Up-scattering effect in resonances
- **Recommendations and Conclusion : Uncertainty in standard Doppler calculations**

	Cold → HZP 293K 560K	HZP → HFP 560K 900K
Flat Temperature Profile	0%	+8.0%
UO ₂ binding : GM vs LM	+4.0%	+1.3%
AK vs Resonant Upscat	-6.0%	-9.4%

- It is mandatory to take into account the temperature profile at LWR operating condition
- **Crystal binding** in UO₂ fuels is particularly important at **room temperature**
- On the contrary, **resonant up-scattering** is particularly **important for large linear power** (however, the -9% AK bias on Doppler worth is assessed in the Free Gaz approximation)

Uncertainty in FTC neutronic calculations

- Using the previous recommended T_{eff} and the resonant scattering kernel, the **calculation uncertainty components** (1σ) are:

Flat Temp	UO ₂ binding	Up-scattering	Total Unc. 1σ
2%	0.3%	3%	3.6%

- **FTC uncertainty due to nuclear data is small:**

²³⁸ U(n,n')	H(n,n)	²³⁸ U Γ_n, Γ_γ	Total Unc. 1σ
0.6%	0.5%	1.0%	1.3%

⇒ **The total uncertainty on FTC best-estimate calculation amounts to 4%**

Conclusions

- Modeling assumptions in FTC neutronic calculation generate high biases : **2% to 10%**
- Total uncertainty (bias uncert + ND) in FTC best-estimate calculation amounts to **4%(1 σ)**
- Supplementary deterministic biases can occur in MOX due to resonance shielding
- Fuel Temp Coeff measured in the PWR lattice at MINERVE in 1978 from 20°C up to 900°C
4 UO₂ fuel samples ($E_{U235} = 0.2; 0.7; 3.0; 5.1\%$) & 6 MOX fuel samples
⇒ TRIPOLI4-DRBC: **(C-E)/E = +3% \pm 3%(1 σ)**

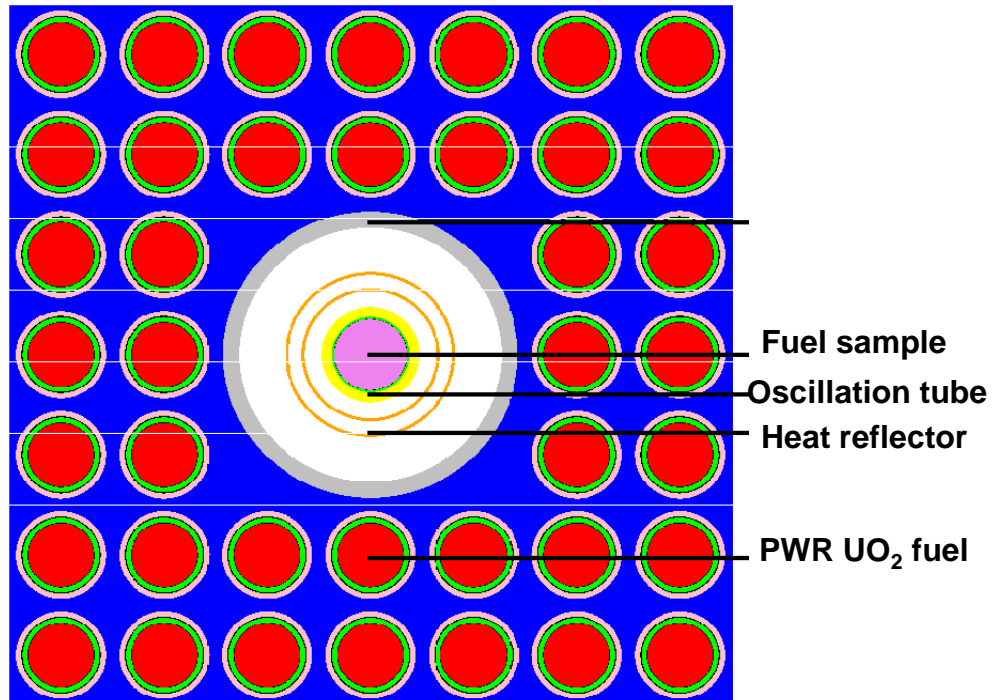

Measured Fuel Temp. reactivity worth vs \sqrt{T}

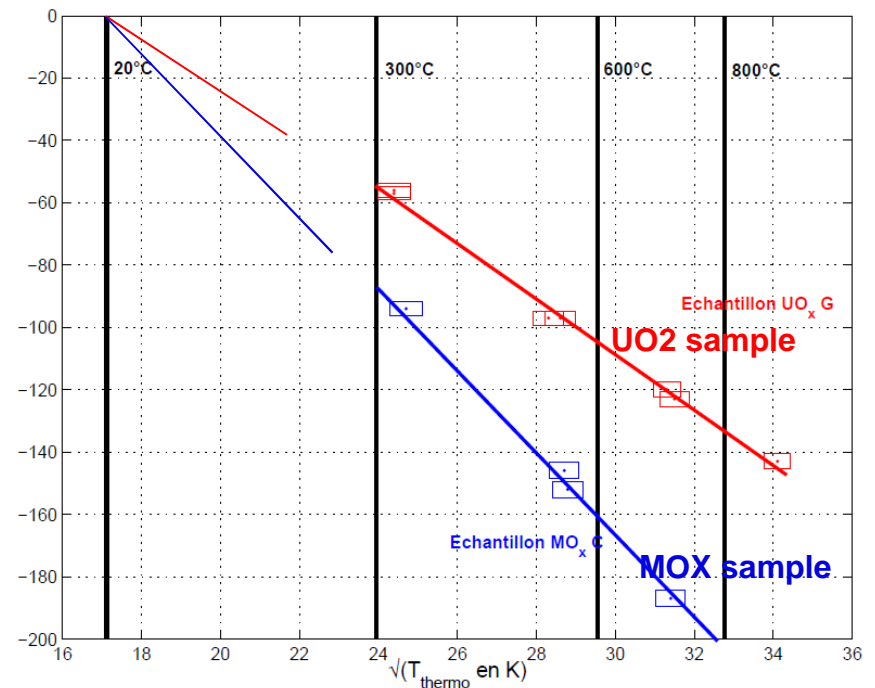

DE LA RECHERCHE À L'INDUSTRIE

cea den

Merci pour votre attention