



**HAL**  
open science

## Tritium trapping by metal oxides in radioactive wastes

A. Le Floch, K. Liger, M. Troulay, P. Guichardon

► **To cite this version:**

A. Le Floch, K. Liger, M. Troulay, P. Guichardon. Tritium trapping by metal oxides in radioactive wastes. Sardinia Symposium - International waste management and landfill symposium, Oct 2015, Perm, Russia. cea-02489578

**HAL Id: cea-02489578**

**<https://cea.hal.science/cea-02489578v1>**

Submitted on 24 Feb 2020

**HAL** is a multi-disciplinary open access archive for the deposit and dissemination of scientific research documents, whether they are published or not. The documents may come from teaching and research institutions in France or abroad, or from public or private research centers.

L'archive ouverte pluridisciplinaire **HAL**, est destinée au dépôt et à la diffusion de documents scientifiques de niveau recherche, publiés ou non, émanant des établissements d'enseignement et de recherche français ou étrangers, des laboratoires publics ou privés.

# TRITIUM TRAPPING BY METAL OXIDES IN RADIOACTIVE WASTES

A. LE FLOCH\*, K. LIGER\*, M. TROULAY\*, P. GUICHARDON\*\*

\* CEA, DEN, Cadarache DTN/SMTA/LIPC, F-13108 Saint-Paul-lez-Durance, France. [Anais.lefloch@cea.fr](mailto:Anais.lefloch@cea.fr)

\*\* Aix Marseille Université, CNRS, Ecole Centrale Marseille, M2P2, UMR7340, Pole de l'Etoile Technopole de Château-Gombert, 38 rue Frédéric Joliot Curie 13451 Marseille, France

**SUMMARY:** Fusion facilities like ITER will produce radioactive waste during operation and dismantling phase. A part of those waste generated by this fusion machine are tritiated waste that have to be managed. One of the main issues in tritiated waste management is the confinement of tritium which presents a good ability to diffusion. One of the solutions is to trap the tritium degassed from waste directly in waste drums. In containers tritium is under gaseous form (HT and T<sub>2</sub>), tritiated water vapor (HTO and T<sub>2</sub>O) and some traces of organic bounded tritium species (OBT). As a hydrogen isotope, HT and T<sub>2</sub> conversion in HTO and T<sub>2</sub>O is possible thanks to a reaction with a mix of metal oxides MnO<sub>2</sub> and Ag<sub>2</sub>O [2] and tritiated water can be adsorbed on molecular sieve [5]. This paper aims at describing a methodology of developing a trapper, with an experimental part to obtain results on trapper efficiency and a modeling part to forecast impact of trapper on tritium release rate from waste drum.

## 1- INTRODUCTION

ITER (International Tokamak Experimental Reactor) is a fusion machine which should demonstrate scientific and technological feasibility of fusion energy by means of D-T fusion reaction. Therefore, most of the solid radioactive waste produced during operation and dismantling phase (around 34000 tons) will result not only from activation by 14 MeV neutrons, but also from contamination by tritium [8]. Because tritiated hydrogen has a good ability to diffusion, one of the main issues in tritiated waste management is the confinement of tritium.

One of the solutions is to trap tritium degassed from waste directly in waste drums. In containers the degassing tritium can be under gaseous form (HT and T<sub>2</sub>), tritiated water vapor (HTO and T<sub>2</sub>O) and trace of organic bounded tritium species (OBT), which is not consider in the present work. To guarantee the confinement of tritium under various operating conditions, trappers have to respect some criteria as follows:

- The chemical process has to be irreversible,
- The reaction has to have a rapid kinetics and a high trapping capacity,

- The chemical process has to work at ambient temperature and atmospheric pressure,
- Trapper has to be stable in case of incidental event (high temperature, high pressure...),
- No interaction should be observed between trappers and the other radionuclides present in the drum,
- Trapper should not require maintenance, because waste drums will be stored many years.

As tritium is a radioactive isotope of hydrogen with a half-life of 12.32 years, the physical and chemical properties of tritium are very similar to those of hydrogen and should react with oxides as hydrogen does. One of the best way to remove hydrogen is to convert hydrogen into water by means of a mix of manganese oxide  $MnO_2$  and silver oxide  $Ag_2O$  with proportions of 90% of  $MnO_2$  and 10% of  $Ag_2O$  [2]; according to the undermentioned reactions:

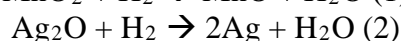

Moreover, X. Lefebvre et al. found in previous study [5] that a good efficiency of 30 cm<sup>3</sup> of trapped tritium /g of powder is reached by adding platinum in the mix of  $MnO_2/Ag_2O$  and a zeolith molecular sieve, which offers an adsorption capacity of 20g of water/100 g of sieve to adsorb formed tritiated water.

The present paper aims to describe the different steps forecasted to develop a trapper for tritiated hydrogen inside radioactive waste drum. An experimental study will enable to determine the higher trapper efficiency (with testing different formulation of powders), the conversion reaction kinetics and it will enable to study the mechanism of tritiated water adsorption. Those experimental data will be used for tritium trapping modeling. The modeling part aims to determine the influence of trapper on tritium release rate from a waste drum. To that, a step of diffusion modeling will be done to find tritium release rate without trapper. Then, using kinetics data obtained during the experimental phase, trapping modeling will be established in view to determine the effect of trapper on tritium release rate.

## 2- STUDY OF TRITIUM TRAPPING

Trapper is a mix of oxidizing powder and molecular sieve. Tritiated hydrogen trapping require two steps. First, tritiated hydrogen molecules H-T and T<sub>2</sub> are converted in tritiated water HTO and T<sub>2</sub>O with oxidizing powder. Then, this water formed is adsorbed irreversibly on molecular sieve.

### 2.1 Conversion reaction

Study of conversion reaction will enable to obtain kinetics data to model tritiated hydrogen reaction inside drum. Twenty powders will be prepared with different formulations in order to find the powder with best efficiency for HT conversion. To that, several tests will be done on a specific facility using hydrogen as a simulant of tritiated hydrogen (see paragraph 2.3).

### 2.2 Oxidizing powders

#### 2.2.1 Formulation of powders

As V.Chaudron shows [2], oxidizing powder to convert hydrogen in water is a mix of 90% of  $MnO_2$  and 10% of  $Ag_2O$ . As an add of catalyzers as platinum, palladium and copper to oxidizing powder can have an influence on conversion reaction efficiency [9], four different powders will

be prepared to compare catalyzer influence: a reference and three other mixes with an add of 1% of a catalyzer. Oxidizing powders are prepared using the same protocol as V.Chaudron [2]. Both of oxides  $MnO_2$ ,  $Ag_2O$  and catalyzer are firstly weighted, crushed in a milling machine and screened. Then, for 20 g of powder, 8 mL of water is added to soak the mix of oxides. Last step consists of heating the powder up to  $100^\circ C$  during 2h to remove any trace of water.

For the soak step, some salt solutions can be used, as: NaOH, KOH,  $CoSO_4$  and  $NiCl_2$  solutions, which can also improve the efficiency of the powder [1]. So, sixteen other powders will be prepared similarly as the previous ones, but soaked with one of those four solutions as water substituent. Table 1 is a summary of the different powders to study.

Table 1 : Composition of the different powders to study

<i>Powder</i>	<i>Composition</i>	<i>% MnO<sub>2</sub></i>	<i>% Ag<sub>2</sub>O</i>	<i>% Catalyst</i>	<i>Solution of impregnation</i>
1	$MnO_2/Ag_2O$	90	10	0	Water
2	$MnO_2/Ag_2O + Pt$	89	10	1	Water
3	$MnO_2/Ag_2O + Pd$	89	10	1	Water
4	$MnO_2/Ag_2O + Cu$	89	10	1	Water
5	$MnO_2/Ag_2O$	90	10	0	KOH
6	$MnO_2/Ag_2O + Pt$	89	10	1	KOH
7	$MnO_2/Ag_2O + Pd$	89	10	1	KOH
8	$MnO_2/Ag_2O + Cu$	89	10	1	KOH
9	$MnO_2/Ag_2O$	90	10	0	NaOH
10	$MnO_2/Ag_2O + Pt$	89	10	1	NaOH
11	$MnO_2/Ag_2O + Pd$	89	10	1	NaOH
12	$MnO_2/Ag_2O + Cu$	89	10	1	NaOH
13	$MnO_2/Ag_2O$	90	10	0	$CoSO_4$
14	$MnO_2/Ag_2O + Pt$	89	10	1	$CoSO_4$
15	$MnO_2/Ag_2O + Pd$	89	10	1	$CoSO_4$
16	$MnO_2/Ag_2O + Cu$	89	10	1	$CoSO_4$
17	$MnO_2/Ag_2O$	90	10	0	$NiCl_2$
18	$MnO_2/Ag_2O + Pt$	89	10	1	$NiCl_2$
19	$MnO_2/Ag_2O + Pd$	89	10	1	$NiCl_2$
20	$MnO_2/Ag_2O + Cu$	89	10	1	$NiCl_2$

### 2.2.2 Characterization of powders

As specific area of powders can have an influence on efficiency of oxidizing reaction, BET tests will be carried out to highlight relation between specific area and efficiency. As shown in Table 2, a first powder (named powder A, similar to powder number 1) with 90% of  $MnO_2$  and 10% of  $Ag_2O$  was used and BET measurement indicates a very small specific area of  $4m^2/g$ , in comparison with other powders. The three other powders coming from previous research [2] [3] [5] show good trapping capacity (which is a way to determine if a powder is efficient or not) with higher specific area.

Moreover, with the aim of determining the phenomenological aspects of the trapping phenomena, characterization of this material is foreseen and other measurements will be carried out. Powders sizes will be studied and X-Ray Diffraction (XRD) analysis will be done on powder chosen before and after oxidizing reaction in order to check if compounds were formed during the reaction.

Table 2: Comparison with results in literature

	<i>Lefebvre's powder [5]</i>	<i>Powder A</i>	<i>Chaudron's powder[2]</i>	<i>Galliez's powder [3]</i>
<i>Composition</i>	90% MnO <sub>2</sub> 10% Ag <sub>2</sub> O	90% MnO <sub>2</sub> 10% Ag <sub>2</sub> O	90% MnO <sub>2</sub> 10% Ag <sub>2</sub> O	87% MnO <sub>2</sub> 13% Ag <sub>2</sub> O
<i>Operating conditions</i>	1,2bar – 25°C 0,01% H <sub>2</sub>	1,2bar – 25°C 0,01% H <sub>2</sub>	2bar – 25°C 50% H <sub>2</sub>	1,6bar – 25°C 4% H <sub>2</sub>
<i>Trapping capacity (cm<sup>3</sup>/g)</i>	23	2,23	42,5	76,4
<i>Specific area (m<sup>2</sup>/g)</i>	68,6	4,7	82	161

## 2.2 The facility

The study of the conversion reaction is developed in a facility composed of a fixed bed reactor.

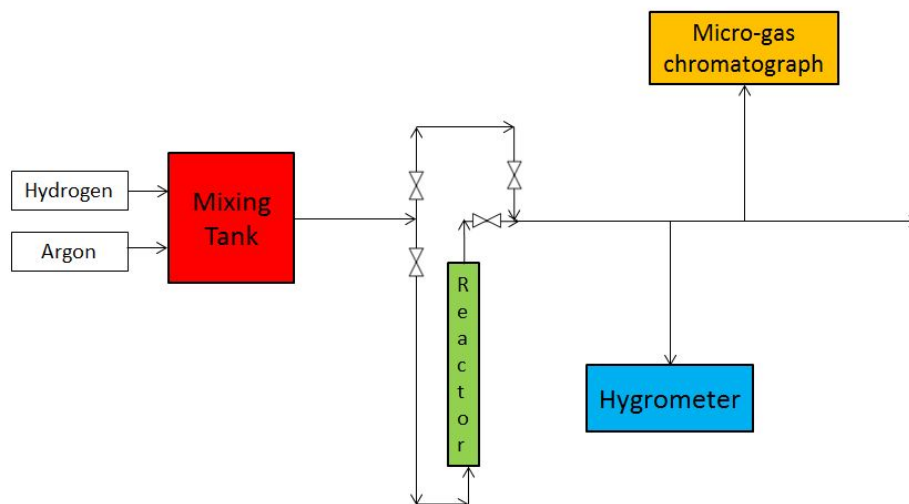

Figure 1 : Schematic representation of the facility

As Figure 1 indicates, a mix of hydrogen and argon (as carrier gas) is done in the mixing tank in order to have a gaseous flow with a concentration around 130 Vppm of hydrogen, which corresponds nearly to the concentration of tritiated hydrogen inside package wastes [6]. Then, mixed gases pass inside the reactor which is filled with of reactive powder and glass balls (see Figure 2).

There are two analyses equipments to obtain information on conversion reaction:

- A micro-gas chromatograph analyzer R-3000 SRA Instruments®, with a molecular sieve column, which enables to measure concentration of hydrogen during tests,
- A hygrometer S4000 Michell Instruments®, which enables to get water concentration so that the mass balance of the reaction can be established.

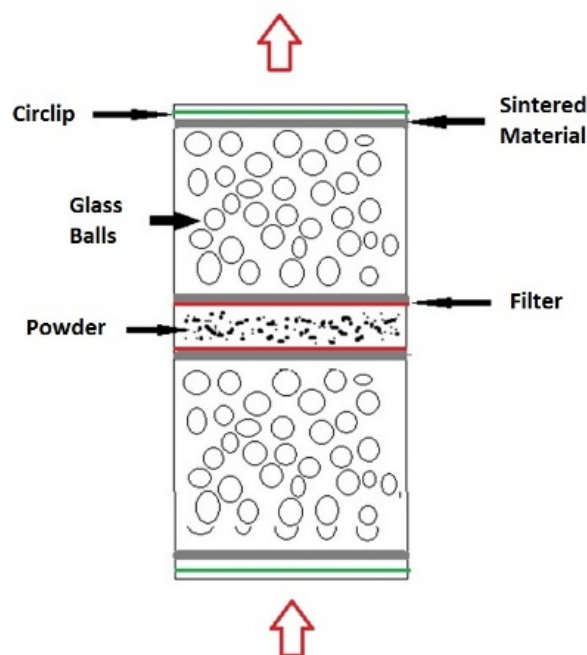

Figure 2 : The reactor

Concerning operating conditions, trapping criteria seen previously have to be respected, with ambient temperature and atmospheric pressure. Table 3 is describing the different values of operating conditions.

Table 3: Operating conditions

<i>Temperature (°C)</i>	<i>Pressure (bar)</i>	<i>Powder mass (g)</i>	<i>Ar flow rate (L/min)</i>	<i>H<sub>2</sub> flow rate (mL/min)</i>
16-25	1-1,3	1-4	0,2-7	0,1-4

### 2.3 Determination of trapping capacity

Trapping capacity ( $C_a$ ), in  $\text{cm}^3/\text{g}$  of powder, is an important value to determine for each powder because it will enable to find the most efficient powder that will be associated to molecular sieve for the trapping, by comparing experimental results. This physical quantity represents the volume of hydrogen trapped by the mass of powder put in the reactor.

The trapping capacity is determined by means of mass balance on hydrogen and water. The amount of hydrogen consumed or water produced can be directly estimated for the breakthrough curves (see Figures 3 and 4), which represent the variation of  $\text{H}_2$  and  $\text{H}_2\text{O}$  concentrations at the reactor outlet ( $C_s$ ).

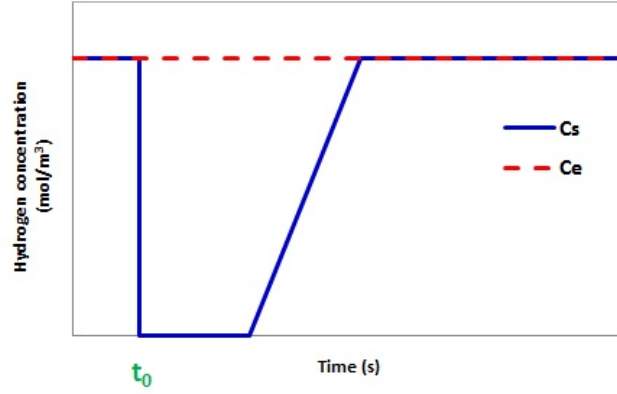

Figure 3 : Ideal breakthrough curve of hydrogen ( $t_0$  represents the beginning of the experiment)

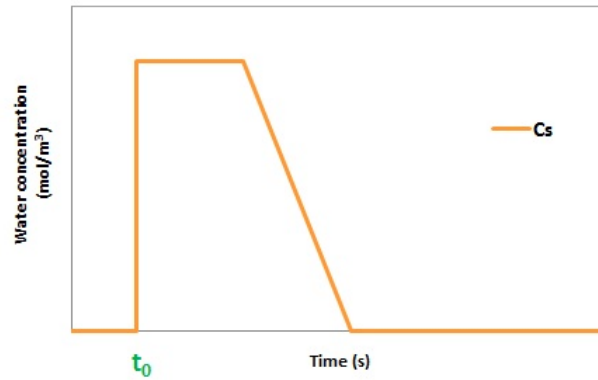

Figure 4 : Ideal breakthrough curve of water ( $t_0$  represents the beginning of the experiment)

Those graphs will enable to obtain molar quantities of  $H_2$  consumed and  $H_2O$  produced by the reaction, in considering  $H_2$  and  $H_2O$  as perfect gases, formula (1) and (2) can be applied.

$$n_{H_2\text{consumed}} = Q \int_{t_0}^{t_f} (C_e - C_s) dt \quad (1)$$

$$n_{H_2O\text{produced}} = Q \int_{t_0}^{t_f} C_s dt \quad (2)$$

Where  $n_{H_2\text{consumed}}$  and  $n_{H_2O\text{produced}}$  are molar quantities of consumed hydrogen and produced water.

$C_e$  and  $C_s$  are, respectively, the inlet and the outlet concentrations ( $\text{mol}/\text{m}^3$ ) and  $Q$  is the volume flow rate ( $\text{m}^3/\text{s}$ ).

Trapping capacity is calculated with volume of  $H_2$  consumed, at ambient temperature and atmospheric pressure, as:

$$C_a = \frac{V_{H_2\text{consumed}}}{m_{\text{powder}}} \text{ in } \text{cm}^3/\text{g} \quad (3)$$

As soon as powder with the best efficiency will be found, study of conversion reaction kinetics will be investigated to obtain reaction rate that will be used in modeling of trapping phenomenon. Experimental conditions will be chosen closed to X.Lefebvre's tests (ambient temperature, atmospheric pressure, 4g of powder, bed thickness of 0,4 cm, 130Vppm of H<sub>2</sub> and gas flow around 750 mL/min) [4]. Results will be compared to theoretical model Bi-Kinetics Model (BKM) as determined by X.Lefebvre [6].

Then experiments with adsorber (with capacity of water trapping of 20g of water/100g of adsorber) will be carried out in order to check tritium trapping efficiency of oxidation-adsorption coupling.

After obtained those experimental results, modeling of trapping phenomenon of tritiated species inside waste drum will be developed; it will be assumed adsorber will be in excess in drum to consider tritiated water formed as totally adsorbed, to focus study of diffusion on tritiated hydrogen.

### 3- STUDY OF TRITIUM DIFFUSION INSIDE DRUM

#### 3.1 Behaviour of tritium inside waste

Inside waste, tritium released from the waste may be under different forms : gaseous with HT, T<sub>2</sub> and as tritiated water vapor HTO and T<sub>2</sub>O. At the beginning of radioactive waste drum life, tritium is present in waste inside drum; as Figure 5 shows, tritium is released from waste and then released from drum.

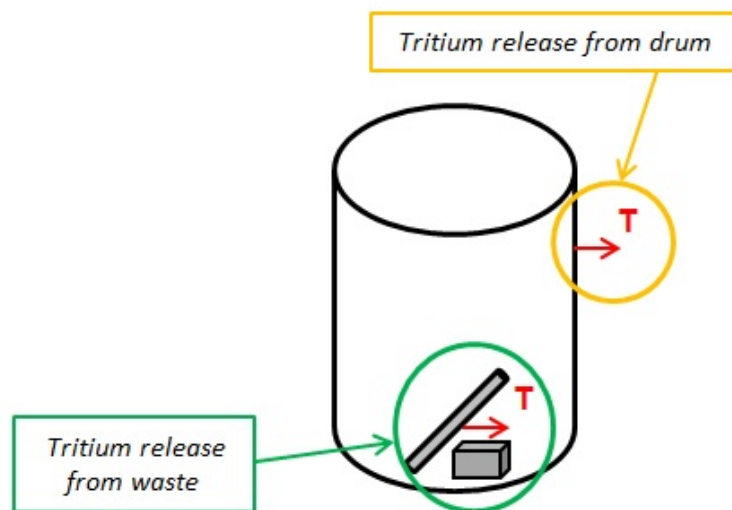

Figure 5 : Tritium release

In case of chemical molecules, phenomenon to pass through wall drum is called permeation. It is a phenomenon which carried out in about seven steps : molecular dissociation (H-T, T-T, HTO and T<sub>2</sub>O); adsorption; absorption; diffusion inside metal; desorption; deadsorption and molecular recombination [11]. As diffusion is mainly the limiting step of permeation [11], this study with COMSOL Multiphysics<sup>®</sup> software will be focused on diffusion of tritiated species, particularly on HT diffusion because it is more mobile than HTO [4] and because it is assumed HTO presents in drum is totally adsorbed with molecular sieve.

#### 3.2 Diffusion phenomena through wall drum



### 3.2.1 Hypothesis and experimental conditions

Diffusion Model development of tritiated hydrogen through wall drum, is based on different assumptions:

- Tritium concentration inside drum is homogeneous,
- Tritium concentration outside drum is null,
- Internal and external temperatures are considered constant,
- Drum material is stainless steel,
- Drum is a cylinder,
- Tritium degassing rate of wastes per year depends linearly to the inventory of tritium in the waste,
- Void fraction inside drum is not null,
- Drum is considered welded and water-resistant,
- At time 0 wall drum does not contain tritiated molecules.

### 3.2.2 Model equations

A cylindric geometry is used in considering an invariance with rotation following  $\Theta$  thanks to homogeneity of tritium concentration inside drum. Figure 6 shows specific volume to mass balance.

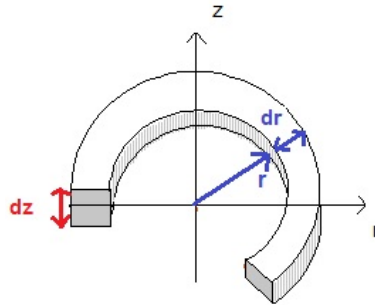

Figure 6 : Calculation conditions

With using Fick's law and with considering tritium disintegration, mass balance of system is :

$$\frac{\partial C(r,z,t)}{\partial t} - D \left( \frac{1}{r} \frac{\partial}{\partial r} \left( r \frac{\partial C(r,z,t)}{\partial r} \right) + \frac{\partial^2 C(r,z,t)}{\partial z^2} \right) = - \lambda \cdot C(r,z,t)$$

With :

C tritium concentration inside drum (mol/m<sup>3</sup>),

D diffusion coefficient of tritium through drum wall (m<sup>2</sup>.s<sup>-1</sup>),

$\lambda$  decay constant of tritium (s<sup>-1</sup>).

To determine C, boundary conditions, see Figure 7, are:

$$C(x=0,t)=C_0$$

$$C(x=e,t)=0$$

$$C(x,t=0)=0$$

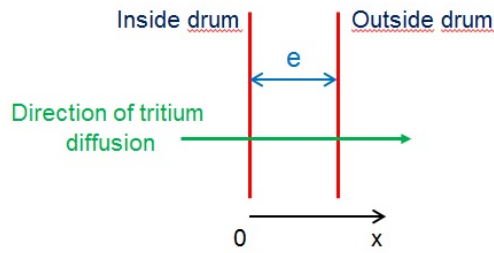

Figure 7 : Boundary conditions

$C_0$  concentration is calculated thanks to the Sievert's law [7] [10], concerning gases dissolution in solid metals, which is relevant for diatomic gases:  $C_0 = K_s \sqrt{P}$

Where :

$K_s$  is the Sievert's constant ( $\text{mol.m}^{-3}.\text{Pa}^{-1/2}$ ),

$P$  is the tritiated hydrogen partial pressure inside drum (Pa).

$K_s$  is obtained with tritium diffusion and permeation coefficients ( $D$  and  $P_e$ ) :  $K_s = \frac{P_e}{D}$

$D$  et  $P_e$  are determined with Tison's correlations and with temperature  $T$  in Kelvin [11] :

$$D = 6,2 \cdot 10^{-7} \exp\left(\frac{-6456,67}{T}\right) \text{ in } \text{m}^2.\text{s}^{-1}$$

$$P_e = 2,30 \cdot 10^{-7} \exp\left(\frac{-7739,96}{T}\right) \text{ in } \text{mol.m}^{-1}.\text{s}^{-1}.\text{Pa}^{-1/2}$$

Partial pressure is determined thanks to a specific formula :

$$P = \frac{A_m r [1 - (1 - \tau)^t] e^{-\lambda t} R T}{f V \lambda N_a}$$

With :

$A_m$ : specific activity of tritium in waste at time 0 (Bq/g),

$r$ : packing factor ( $\text{t.m}^{-3}$ ),

$\tau$ : outgassing rate of waste inside drum,

$f$ : void fraction inside drum,

$N_a$ : Avogadro's number,

$R$ : constant of perfect gases

$V$ : internal volume of the drum, and other terms are defined before.

Formula of partial pressure of tritiated hydrogen in the package is obtained with perfect gases law such as :

$$P = \frac{n_{\text{released}}.R.T}{V_{\text{void}}}$$

With :

$n_{\text{released}}$  : the amount of HT released in the package by the waste such as:

$$n_{\text{released}} = n_0 [1 - (1 - \tau)^t] e^{-\lambda t}, \text{ where } n_0 = \frac{A_m.r.V}{\lambda.N_a}$$

And  $V_{\text{void}}$  is the void volume inside drum =  $f.V$ .

This modeling step will enable to obtain quantity of tritium release outside drum over time because of diffusion phenomenon.

#### 4- COUPLING OF BOTH PHENOMENA AND PARAMETRIC STUDY

For coupling of both phenomena, mass balance is written with an added reaction kinetics term beforehand determined with experimental tests:

$$\frac{\partial C(r,z,t)}{\partial t} - D \left( \frac{1}{r} \frac{\partial}{\partial r} \left( r \frac{\partial C(r,z,t)}{\partial r} \right) + \frac{\partial^2 C(r,z,t)}{\partial z^2} \right) = - \lambda \cdot C(r,z,t) + R$$

Where R is the term corresponding to trapping influence on tritium release, in mol/m<sup>3</sup>/s.

Different parameters will be used to know the real impact they have on tritium release. Wall drum thickness and internal temperature are two main parameters that can be varied to analyze their influence on tritium release. Then for modeling, variation of wall drum thickness with a value between 3 and 5 mm and variation of internal temperature with a value between 40 and 60°C will be tested.

#### 5- CONCLUSIONS

Trapper is an association of oxidizing powders, which may contain a catalyzer (Pt, Pd or Cu) and remains of salts, to convert HT and T<sub>2</sub> in tritiated water, and adsorber, to catch HTO and T<sub>2</sub>O. This present work, coupling experimental and modeling, will determine the real impact of the trapper proposed on tritium release rate from a radioactive waste drum in which one tritium trapper was filed.

Next papers will develop results of experimental tests, conversion reaction kinetics and modeling.

#### REFERENCES

- [1] Charcosset et al., 1971- Increase of reductibility of NiO by H<sub>2</sub>, due to pretreatment with salt solutions - Journal of catalysis 22 204-212
- [2] Chaudron et al., 1997 – Experimental evaluation of hydrogen getters as mitigation technique in a fusion reactor – 17<sup>th</sup> IEEE/INPSS Symposium on fusion engineering - San Diego, USA
- [3] Galliez et al., 2013 -Influence of MnO<sub>2</sub> polymorphism form on MnO<sub>2</sub>/Ag<sub>2</sub>O hydrogen getter - Journal of Nuclear Materials 438 261-267
- [4] Lefebvre et al, 2011- Limitation of tritium outgassing from fusion reactors waste drums : Theoretical aspects of hydrogen oxidation - Fusion engineering and design 86 2398-2402
- [5] Lefebvre et al., 2011 – Procédé et dispositif de réduction du dégazage de déchets tritiés issus de l'industrie nucléaire – Patent FR 1161500
- [6] Lefebvre et al., 2011- Theoretical study of the reactivity of mixed manganese and silver oxides on hydrogen simulating tritium for the limitation of outgassing from waste drums – Fusion Science and Technology 60 1276-1279
- [7] Oriani, 1993 - The Physical and Metallurgical Aspects of Hydrogen in Metals - Fourth International Conference on Cold Fusion, Lahaina, Maui.
- [8] Pamela et al., 2014 - ITER tritiated waste management by the Host state and first lessons learned for fusion development – Fusion Engineering and Design 89 2001-2007
- [9] Roman et al., 1973 - Promoter and carrier effects in the reduction of NiO/SiO<sub>2</sub> - Journal of catalysis 30 333-342
- [10] Sievert, 1929 – The absorption of gases by metals – Zeitschrift für metallkunde 21 37-46
- [11] Tison, 1984 – Influence de l'hydrogène sur le comportement des métaux - Rapport CEA-R-5240 (French)