



**HAL**  
open science

## **A macroscopic and molecular study for a complete description of technetium (VII) and uranium (VI) co-extraction mechanism with monoamides**

P. Moeyaert, C. Sorel, T. Dumas, D. Guillaumont, M. Miguiditchian, P. Moisy, Jean-François Dufrêche

### ► To cite this version:

P. Moeyaert, C. Sorel, T. Dumas, D. Guillaumont, M. Miguiditchian, et al.. A macroscopic and molecular study for a complete description of technetium (VII) and uranium (VI) co-extraction mechanism with monoamides. RANC 2016 - The 1st International Conference on Radioanalytical and Nuclear Chemistry, Apr 2016, Budapest, Hungary. cea-02442334

**HAL Id: cea-02442334**

**<https://cea.hal.science/cea-02442334>**

Submitted on 16 Jan 2020

**HAL** is a multi-disciplinary open access archive for the deposit and dissemination of scientific research documents, whether they are published or not. The documents may come from teaching and research institutions in France or abroad, or from public or private research centers.

L'archive ouverte pluridisciplinaire **HAL**, est destinée au dépôt et à la diffusion de documents scientifiques de niveau recherche, publiés ou non, émanant des établissements d'enseignement et de recherche français ou étrangers, des laboratoires publics ou privés.

DE LA RECHERCHE À L'INDUSTRIE

cea den

# A MACROSCOPIC AND MOLECULAR STUDY FOR A COMPLETE DESCRIPTION OF TECHNETIUM (VII) AND URANIUM (VI) CO-EXTRACTION MECHANISM WITH MONOAMIDES

P. Moeyaert<sup>a</sup>, C. Sorel<sup>a</sup>, T. Dumas<sup>a</sup>, D. Guillaumont<sup>a</sup>, M.  
Miguirditchian<sup>a</sup>, Ph. Moisy<sup>a</sup>, J.-F. Dufrêche<sup>b</sup>

<sup>a</sup> CEA Marcoule, DEN / DRCP / SMCS BP 17171  
30207 Bagnols sur Cèze, France.

<sup>b</sup> ICSM BP 17171 30207 Bagnols sur Cèze, France

E-mail: pauline.moeyaert@cea.fr

**RANC 2016**

Budapest, April 12<sup>th</sup> 2016



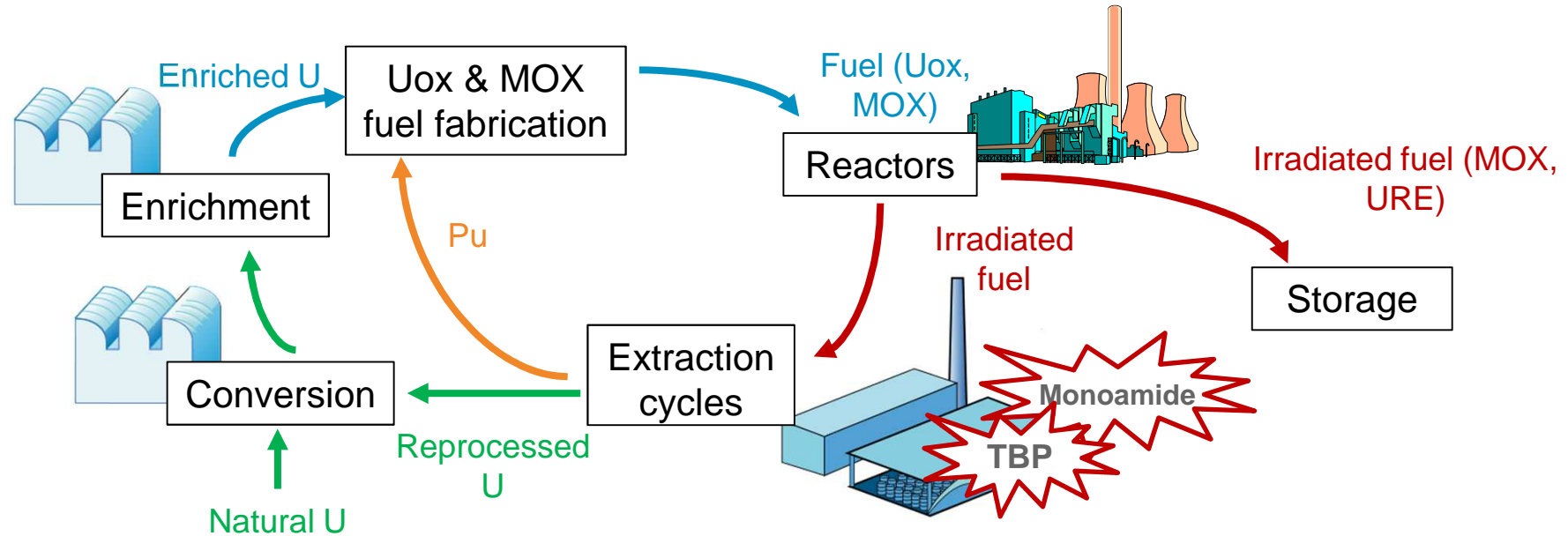

**Monoamides for U & Pu extraction ...**

- Innovative liquid-liquid extraction processes for the reprocessing of spent nuclear fuels
- Good stability towards radiolysis and hydrolysis

**... But what about fission products extraction?**

## Techneium in the PUREX process

- $^{99}\text{Tc}$  = Long-lived  $\beta$  emitting radionuclide (with a radioactive half-life of  $2.1 \times 10^5$  y)
- Radionuclide potentially mobile in the environment
- Present as  $\text{HTcO}_4$  in nitric acid dissolution solutions
- Can cause some issues in the PUREX process if not correctly scrubbed (hydrazine destruction, U & Pu contamination)
- Measurements implemented in La Hague plant

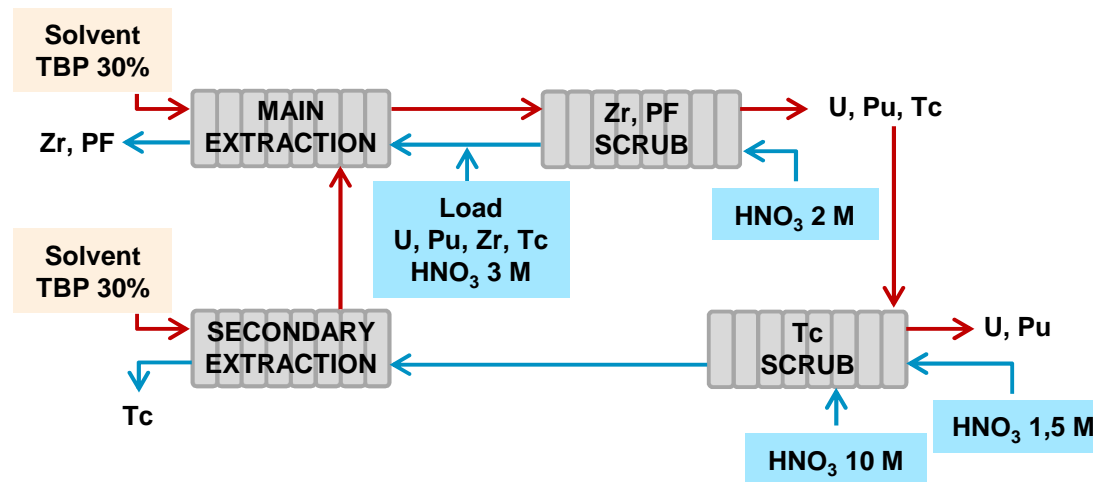

### Techneium in the PUREX process

- $^{99}\text{Tc}$  = Long-lived  $\beta$  emitting radionuclide (with a radioactive half-life of  $2.1 \times 10^5$  y)
- Radionuclide potentially mobile in the environment
- Present as  $\text{HTcO}_4$  in nitric acid dissolution solutions
- Can cause some issues in the PUREX process if not correctly scrubbed (hydrazine destruction, U & Pu contamination)
- Measurements implemented in La Hague plant

### Towards a new process ...

- DEHiBA (N,N-di-2-ethylhexyl-isobutyramide) = promising extractant for future processes

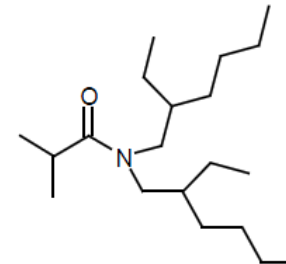

DEHiBA

## Objectives:

- Understanding the mechanisms involved in the extraction of technetium with DEHiBA
  - Modeling technetium extraction
- Integrating the model into the CEA PAREX code to improve the modeling of extraction processes and help flowsheets design

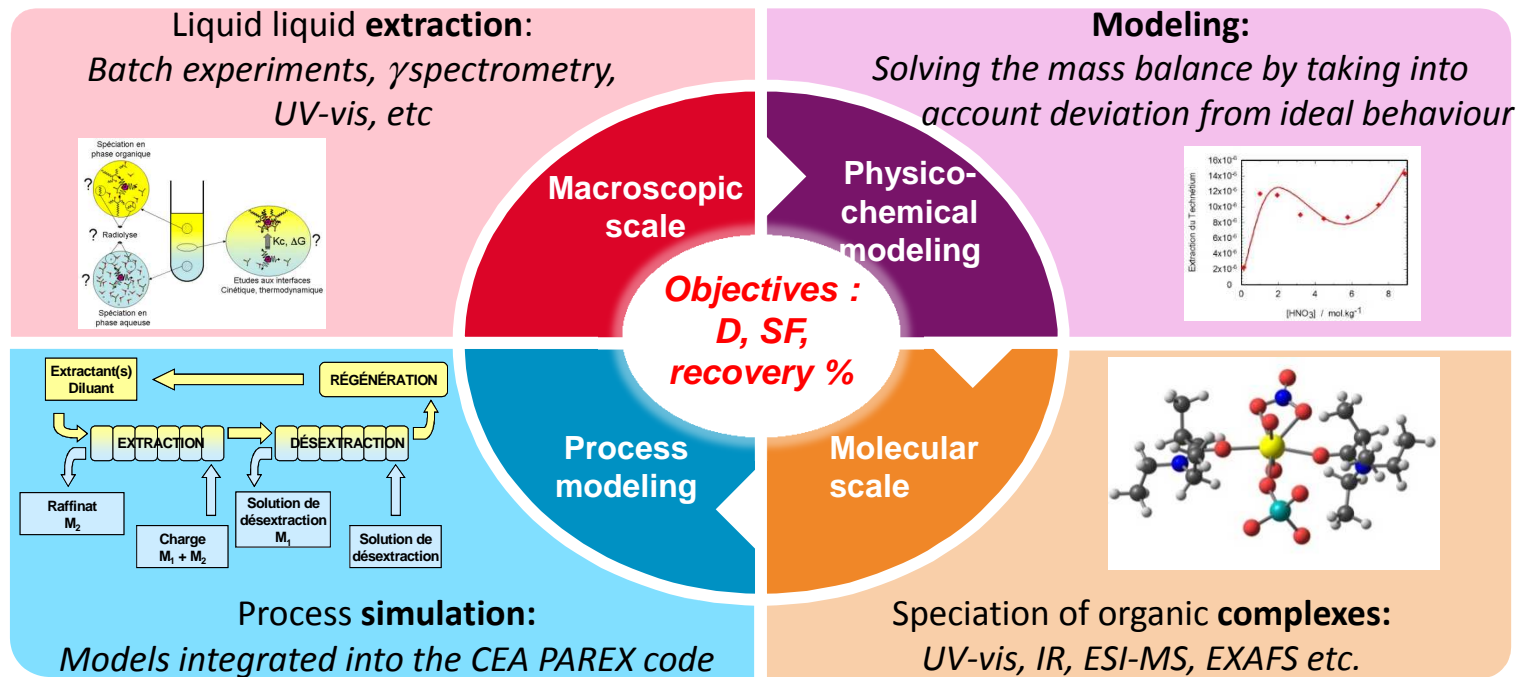

# TECHNETIUM EXTRACTION EXPERIMENTAL PROTOCOLE

## Aqueous phase:

H<sub>2</sub>O  
HNO<sub>3</sub> 0.1-6 M  
UO<sub>2</sub>(NO<sub>3</sub>)<sub>2</sub> 0-120 g.L<sup>-1</sup>  
HTcO<sub>4</sub> 10<sup>-3</sup> M + <sup>99m</sup>Tc as  $\gamma$  spiker

## Organic phase:

DEHiBA / TPH

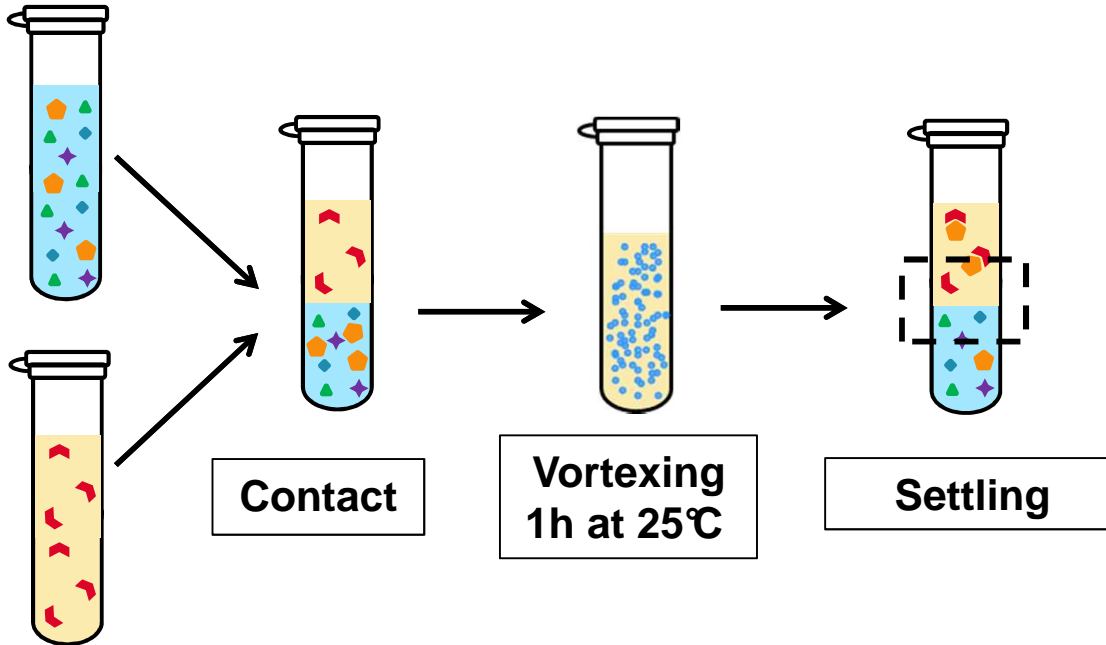

<sup>99m</sup>Tc = short-lived  $\gamma$  emitter ( $T_{1/2} \approx 6$  h)  
Used as spiker for Tc measurements



- Acid base titration
- $\gamma$  spectrometry
- UV-vis spectrophotometry

- Acid base titration
- $\gamma$  spectrometry
- UV-vis spectrophotometry

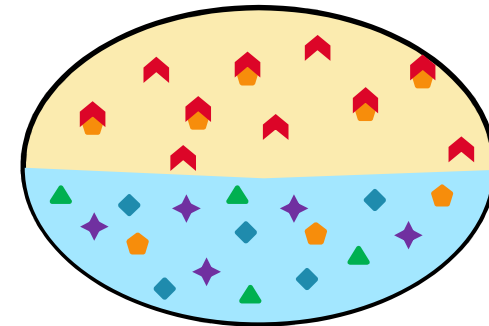

### Experimental results

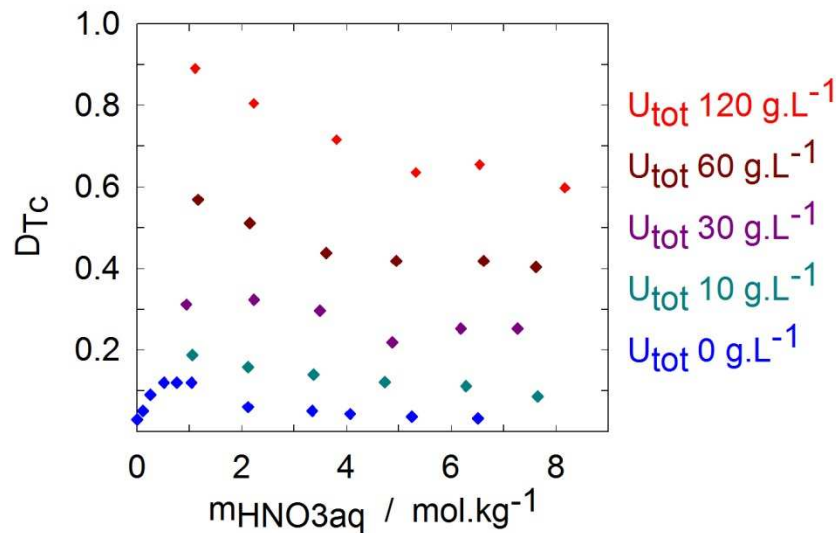

- $D_{Tc} = [Tc]_{org}/[Tc]_{aq} \nearrow$  when  $U_{tot} \nearrow$
- Assumption of the following extraction equilibria:

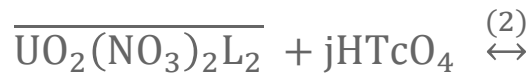

### Mass balance equations

#### Equilibrium constants:

$$K_1 = \frac{\overline{(HTcO_4)L_i}}{[L]^i [HTcO_4]} \frac{\gamma_{\overline{(HTcO_4)L_i}}}{\gamma_{HTcO_4} \gamma_L^i}$$

$$K_2 = \frac{\overline{UO_2(NO_3)_{2-j}(TcO_4)_jL_2} [HNO_3]^j}{[L]^2 [UO_2(NO_3)_2] [HTcO_4]^j} \frac{\gamma_{\overline{UO_2(NO_3)_{2-j}(TcO_4)_jL_2}} \gamma_{HNO_3}^j}{\gamma_{UO_2(NO_3)_2} \gamma_{HTcO_4}^j \gamma_L^2}$$

#### Method:

- Free extractant concentration determined by an iterative method based on dichotomy resolution
- Calculation of U, Tc, H, H<sub>2</sub>O concentrations in organic phase
- Optimization of the unknown parameter K by an iterative method based on least-squares analysis corresponding to the minimization of:

$$\min \sum \left( \frac{[\overline{X}]_{calc} - [\overline{X}]_{exp}}{[\overline{X}]_{exp}} \right)^2$$



## In aqueous phase: the simple solutions theory

- Simple behaviour of isopiestic solutions (Zdanovskii-Stokes-Robinson)
- Mikulin equation to calculate activity coefficients

$$\gamma_{\text{HTcO}_4} = \frac{\nu_{\text{HTcO}_4} \gamma_{\text{HTcO}_4}^{\text{bi}} m_{\text{HTcO}_4}^{\text{bi}}}{\nu_{\text{HTcO}_4} m_{\text{HTcO}_4} + \nu_{\text{HNO}_3} m_{\text{HNO}_3} + \nu_{\text{UO}_2(\text{NO}_3)_2} m_{\text{UO}_2(\text{NO}_3)_2}}$$

Binary mixture data  
= f(a<sub>w</sub>)

Real mixture  
composition

### Procedure for binary data acquisition = triplet (Φ, γ, m)

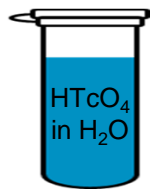

Measurements of water  
activity a<sub>w</sub>



Osmotic coefficient  
calculation

$$\phi = -\frac{\ln a_w}{\nu m M_{\text{H}_2\text{O}}}$$



Activity coefficient of the  
electrolyte by integrating  
Gibbs-Duhem equation

$$\ln \gamma = \phi - 1 + \int_0^m \frac{\phi - 1}{m} dm$$

Fitting according to a semi-empirical  
equation (ex: NIST, Pitzer, ...)

$$\phi = f(m)$$

m = molality  
(mole per kg of solvent)



In aqueous phase: the simple solutions theory

- Simple behaviour of isopiestic solutions (Zdanovskii-Stokes-Robinson)
- Mikulin equation to calculate activity coefficients

$$\gamma_{\text{HTcO}_4} = \frac{v_{\text{HTcO}_4} \gamma_{\text{HTcO}_4}^{\text{bi}} m_{\text{HTcO}_4}^{\text{bi}}}{v_{\text{HTcO}_4} m_{\text{HTcO}_4} + v_{\text{HNO}_3} m_{\text{HNO}_3} + v_{\text{UO}_2(\text{NO}_3)_2} m_{\text{UO}_2(\text{NO}_3)_2}}$$

Binary mixture data  
= f(a<sub>w</sub>)

Real mixture  
composition

Procedure for binary data acquisition = triplet (Φ, γ, m)

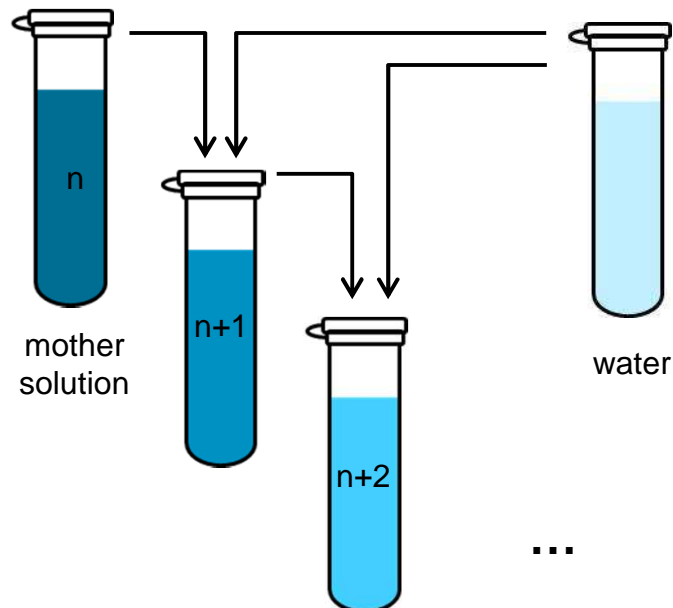

Pertechnetate acid  $\text{HTcO}_4$  binary data = triplet  $(\Phi_{\text{HTcO}_4}, \gamma_{\text{HTcO}_4}, m_{\text{HTcO}_4})$

## New variation of $\gamma = f(m)$

- Boyd's data available in the literature
- New  $a_w$  measurements
- New variation implemented in the models

$$\gamma_{\text{HTcO}_4} = \frac{\nu_{\text{HTcO}_4} \gamma_{\text{HTcO}_4}^{\text{bi}} m_{\text{HTcO}_4}^{\text{bi}}}{\nu_{\text{HTcO}_4} m_{\text{HTcO}_4} + \nu_{\text{HNO}_3} m_{\text{HNO}_3} + \nu_{\text{UO}_2(\text{NO}_3)_2} m_{\text{UO}_2(\text{NO}_3)_2}}$$

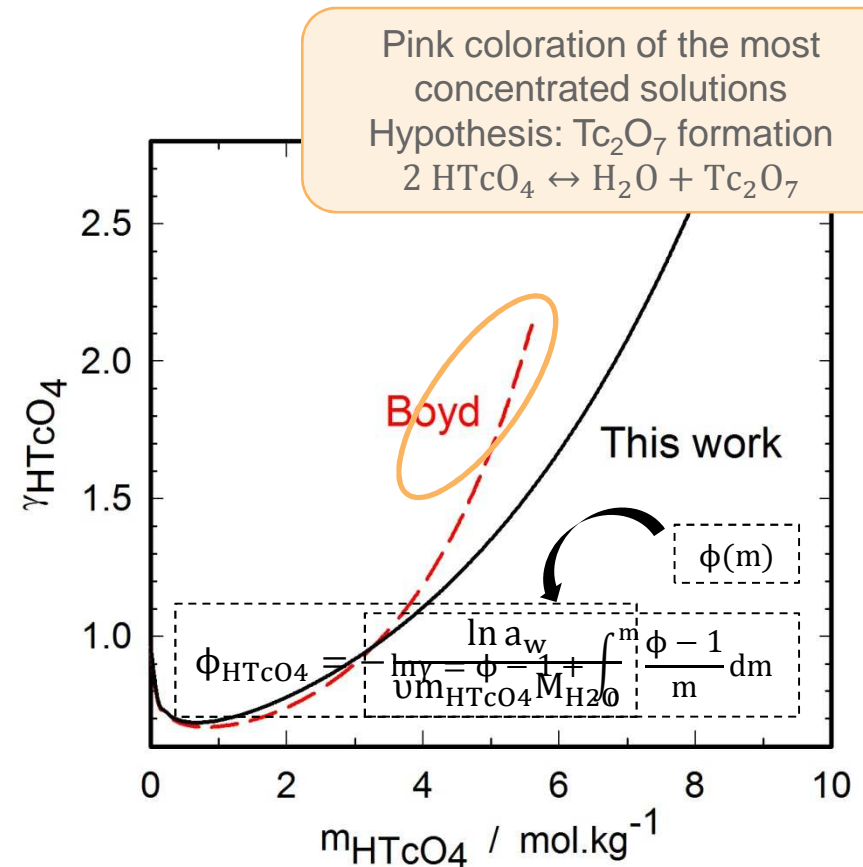

Boyd, G.E., Inorganic Chemistry, 1978. **17**(7): p. 1808-1810.

Moeyaert, P., et al. The Journal of Chem. Therm., 2015. **85**(0): p. 61-67.

Moeyaert, P., et al. The Journal of Chem. Therm., 2015. **91**(0): p. 94-100.

CEA Thesis L. Abiad

# TECHNETIUM EXTRACTION MODELING RESULTS

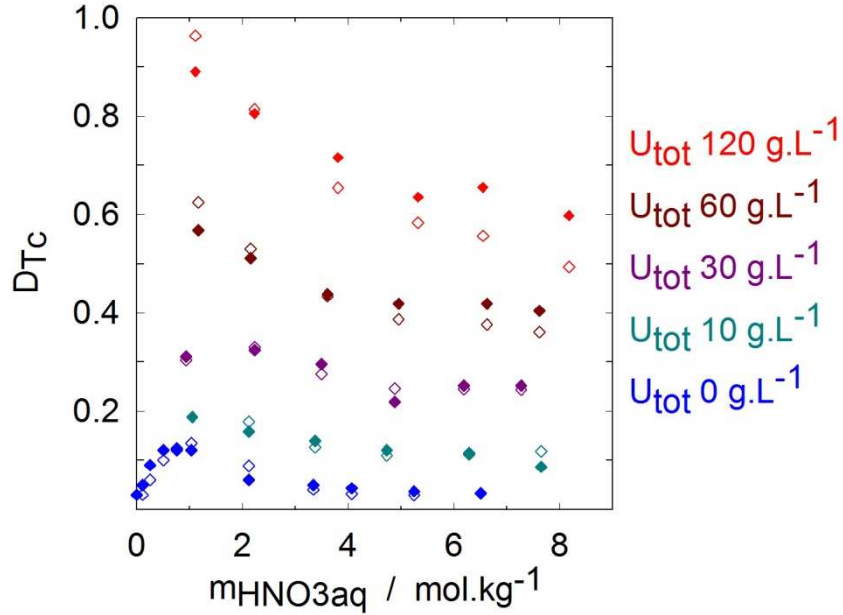

## Main extraction mechanisms:

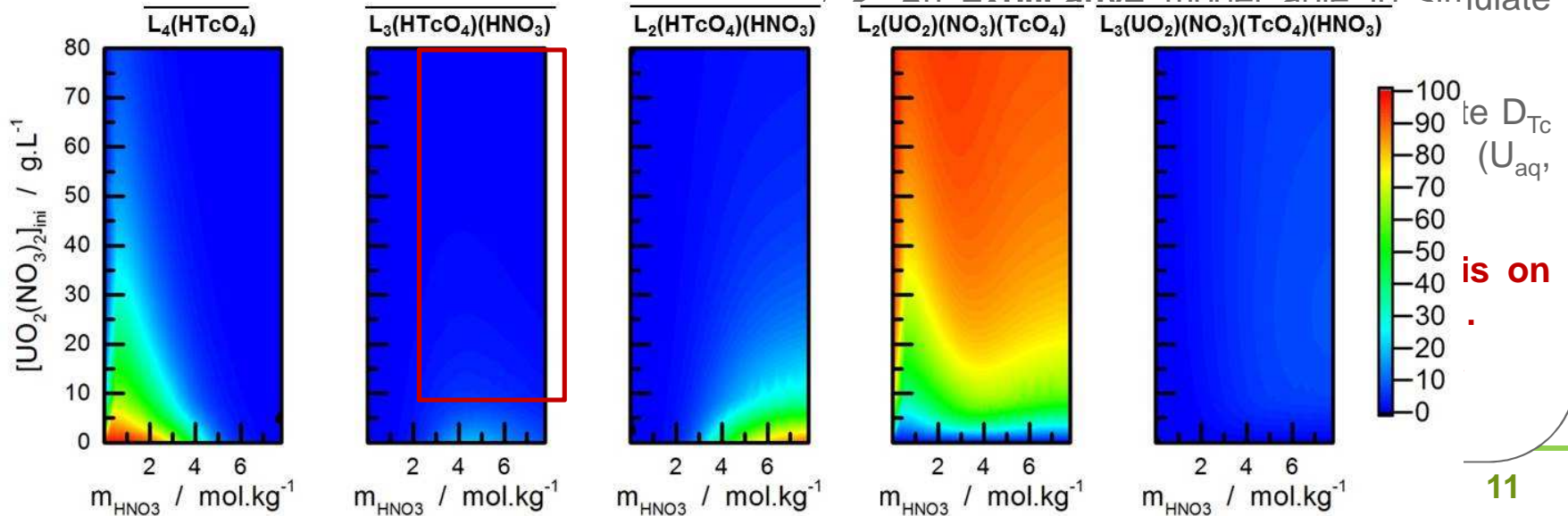
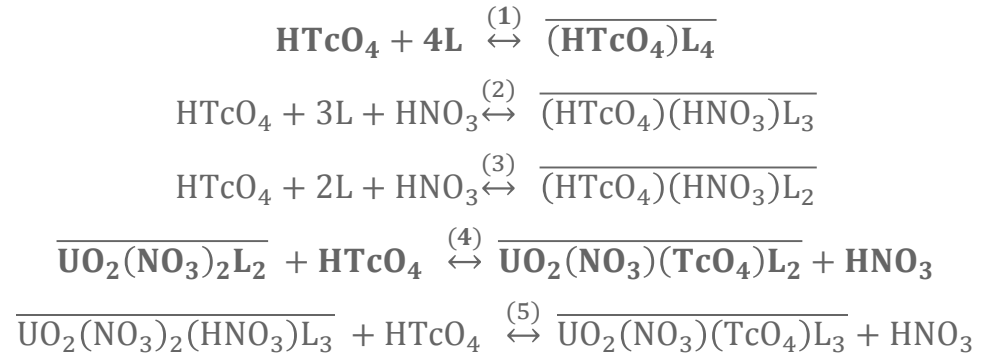

## IR and XAS spectroscopies investigations

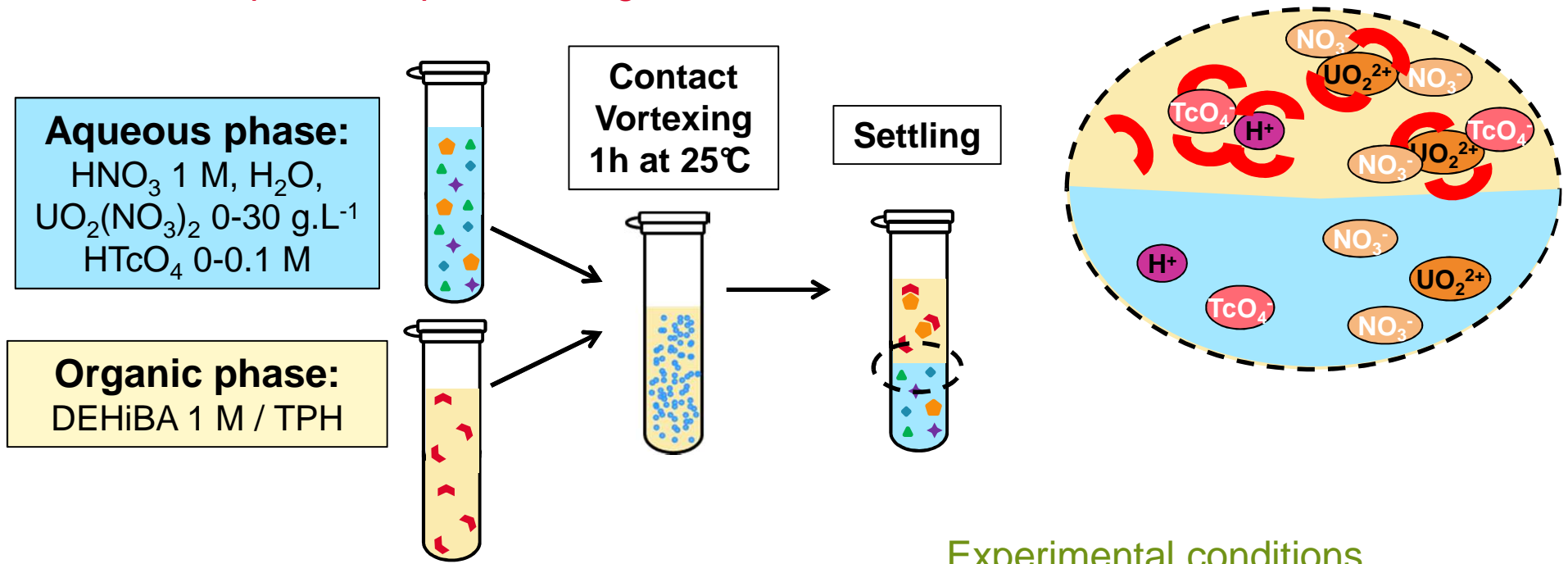

**IR spectroscopy:** influence of the Tc/U ratio

**XAS spectroscopy:** influence of the Tc/U ratio and data processing

DEHiBA- $\text{HNO}_3^-$   
 $\text{UO}_2(\text{NO}_3)_2$

DEHiBA- $\text{HNO}_3^-$   
 $\text{UO}_2(\text{NO}_3)_2$ - $\text{HTcO}_4$

DEHiBA- $\text{HNO}_3^-$   
 $\text{HTcO}_4$

## IR spectroscopy

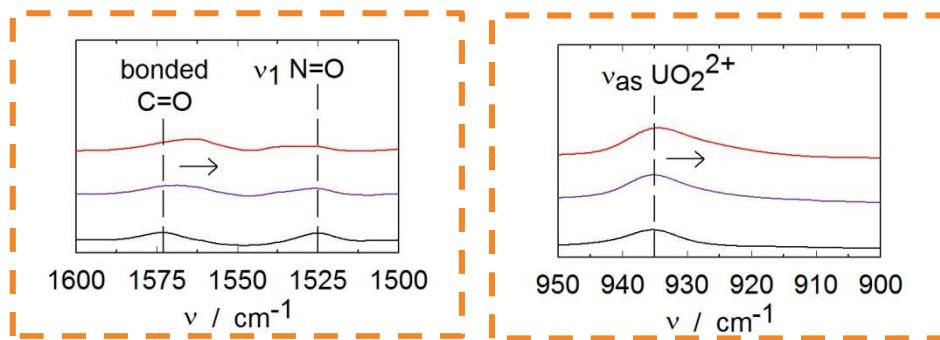
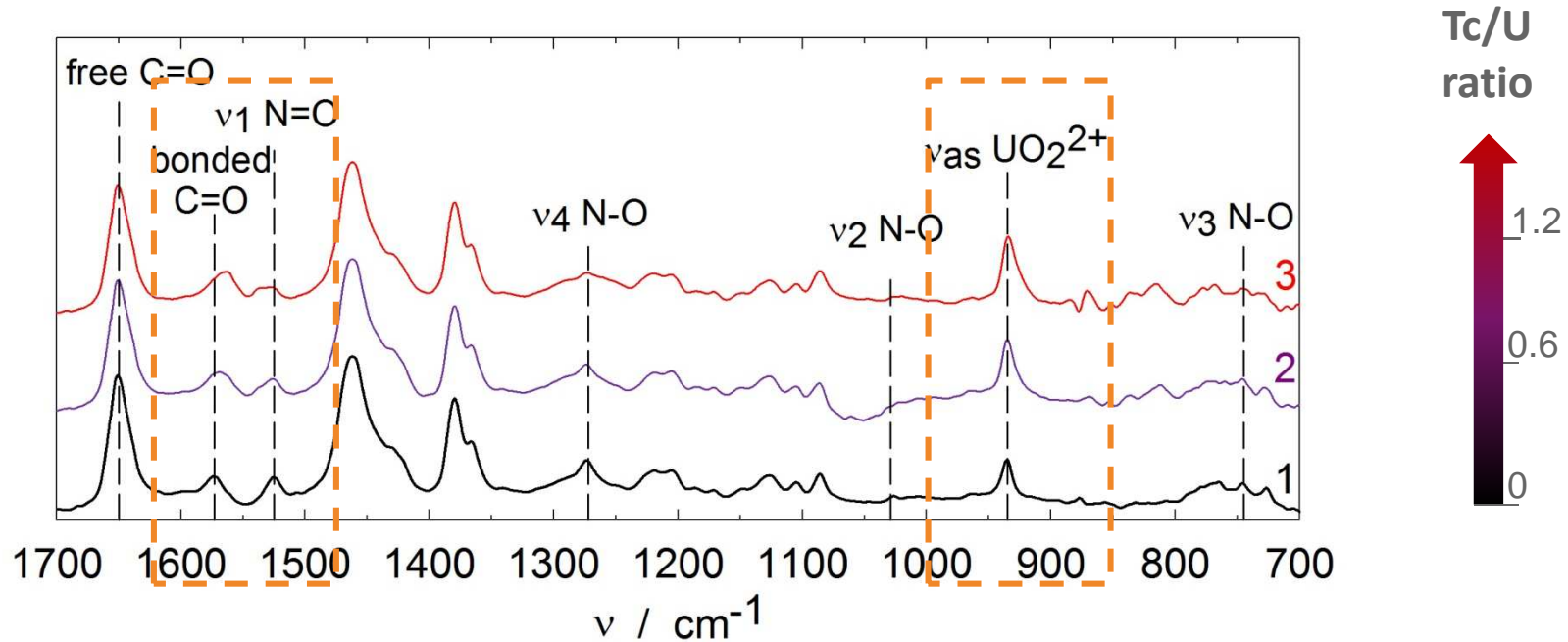

- Bonded C=O and  $UO_2$  stretch shifted to lower frequencies when  $[Tc] \nearrow$
- Changes in the intensity and in the shape of the nitrate  $\nu_1$  N=O stretch when  $[Tc] \nearrow$
- ➔ **Changes are occurring in the U(VI) inner coordination sphere when uranium and technetium are co-extracted**

## IR spectroscopy combined with theoretical calculations (DFT)

- Optimisation of the  $\text{UO}_2(\text{NO}_3)(\text{TcO}_4)\text{L}_2$  complex structure
- Vibrational frequencies calculation for  $\text{UO}_2(\text{NO}_3)_2\text{L}_2$  and  $\text{UO}_2(\text{NO}_3)(\text{TcO}_4)\text{L}_2$  complexes
- ➔ **Confirmation that changes are occurring in the U(VI) inner coordination sphere when uranium and technetium are co-extracted**
- ➔ **Calculated  $\text{UO}_2(\text{NO}_3)(\text{TcO}_4)\text{L}_2$  structure is used as support for XAS data processing**

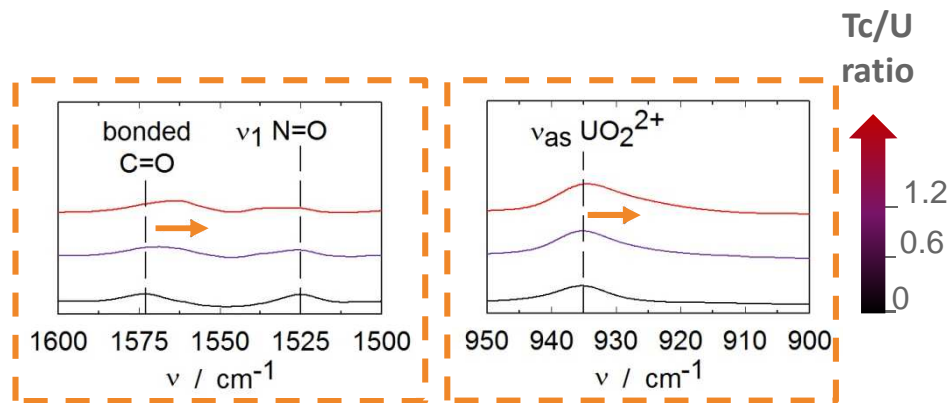
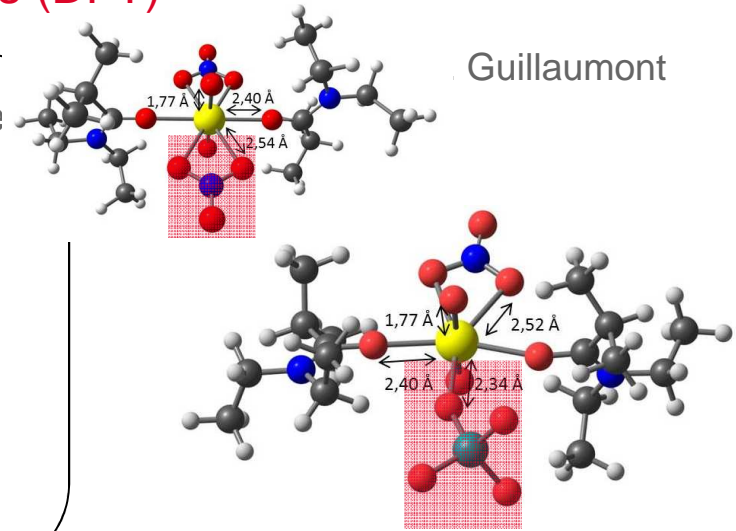

		v / cm <sup>-1</sup>	
		Bonded v C=O	ν <sub>as</sub> UO <sub>2</sub> <sup>2+</sup>
<b>exp</b>	Type of vibration		
	$\text{UO}_2(\text{NO}_3)_2\text{L}_2$	1573	935
		v / cm <sup>-1</sup>	
		Bonded v C=O	ν <sub>as</sub> UO <sub>2</sub> <sup>2+</sup>
<b>calc</b>	Type of vibration		
	$\text{UO}_2(\text{NO}_3)_2\text{L}_2$	1587	933
	$\text{UO}_2(\text{NO}_3)(\text{TcO}_4)\text{L}_2$	1576	930

## XAS spectroscopy

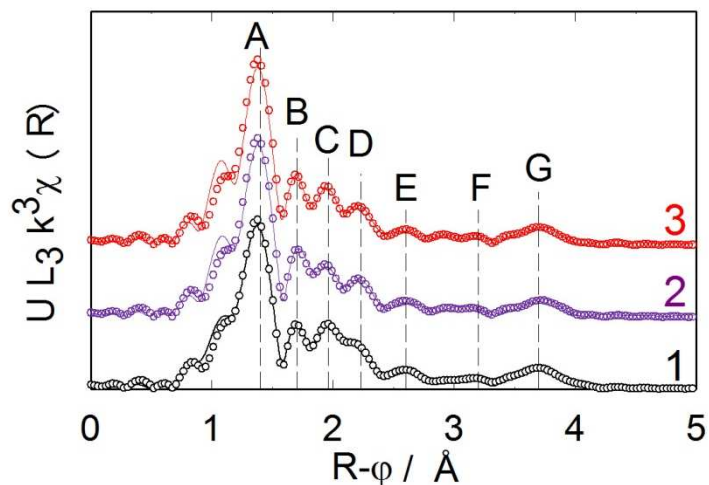

Fourier transform of the  $k^3$ -weighted EXAFS spectra at uranium  $L_3$  edge for U-Tc complexes

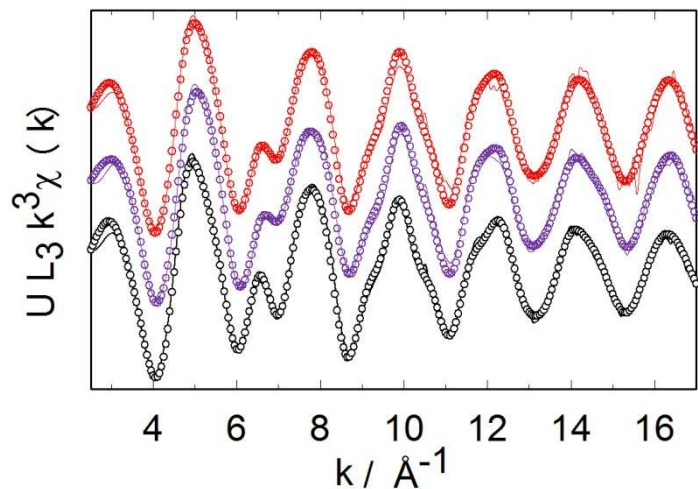

$k^3$ -weighted EXAFS spectra at uranium  $L_3$  edge for U-Tc complexes



	$CN_{U-O_{eq}}$	$d_{U-O_{eq}} / \text{\AA}$
1	6	2.48
2	5.7	2.47

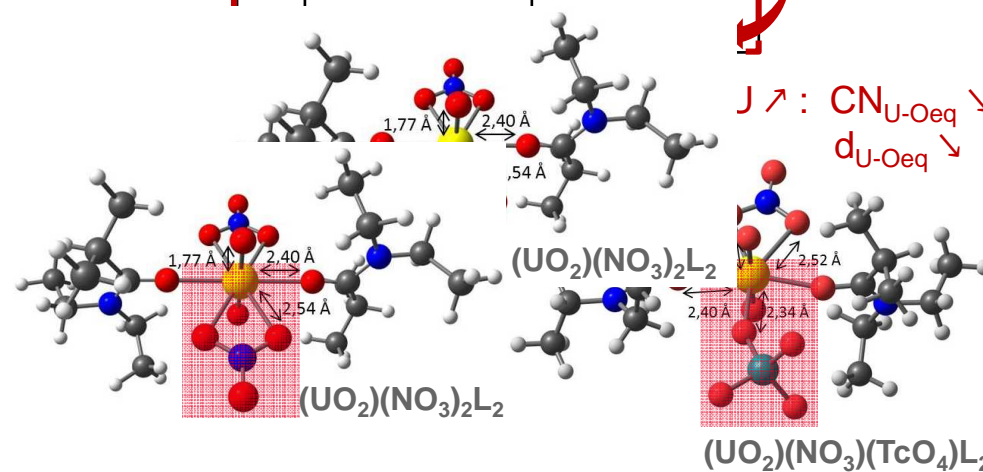

**Confirmation of the suggested co-extraction mechanism of U(VI) and Tc(VII)**

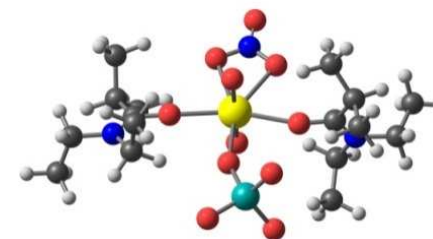



## Liquid liquid extraction:

Batch experiments,  $\gamma$  spectrometry, UV-vis, etc

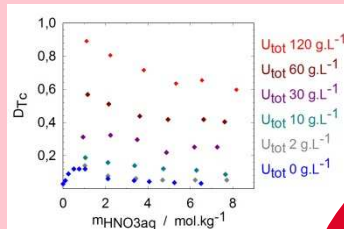
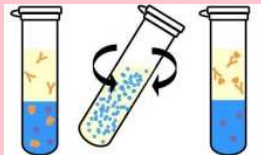

## Modeling:

Solving the mass balance by taking into account deviation from ideal behaviour

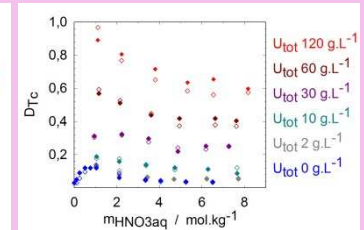
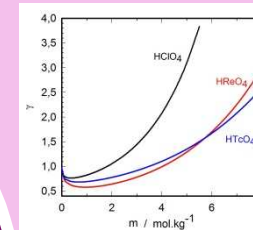

Macroscopic scale

Physico-chemical modeling

Objectives :  
D, SF,  
recovery %

Process modeling

Molecular scale

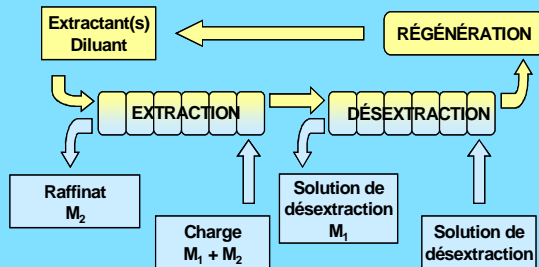

## Process simulation :

Models integrated into the CEA PAREX code

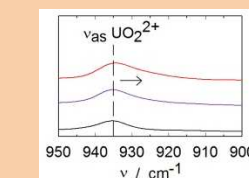
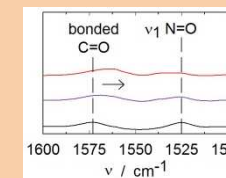
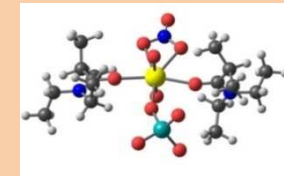
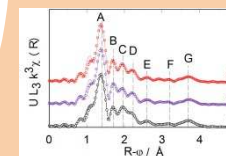

## Speciation of organic complexes:

UV-vis, IR, ESI-MS, EXAFS etc.

Moeyaert, P., et al. Inorg. Chem., 2016. Submitted

## Aknowledgements

Laurence Chareyre  
Dr. Christian Sorel  
Dr. Manuel Miguirditchian  
Dr. Thomas Dumas  
Dr. Dominique Guillaumont  
Dr. Kristina Kvashnina  
Pr. Philippe Moisy  
Pr. Jean-François Dufrêche



# THANK YOU FOR YOUR ATTENTION



Commissariat à l'énergie atomique et aux énergies alternatives  
Centre de Marcoule | BP17171 | 30207 Bagnols-sur-Cèze Cedex  
T. +33 (0)4 66 39 78 66 | F. +33 (0)4 66 79 63 25

Etablissement public à caractère industriel et commercial | RCS Paris B 775 685 019