



**HAL**  
open science

## Non-linear dynamical behavior of a fuel pins bundle.

T. Catterou, V. Blanc, G. Ricciardi, Bruno Cochelin, Stéphane Bourgeois

► **To cite this version:**

T. Catterou, V. Blanc, G. Ricciardi, Bruno Cochelin, Stéphane Bourgeois. Non-linear dynamical behavior of a fuel pins bundle.. Atoms for the future 2016, Jun 2016, Paris, France. cea-02439473

**HAL Id: cea-02439473**

**<https://cea.hal.science/cea-02439473>**

Submitted on 26 Feb 2020

**HAL** is a multi-disciplinary open access archive for the deposit and dissemination of scientific research documents, whether they are published or not. The documents may come from teaching and research institutions in France or abroad, or from public or private research centers.

L'archive ouverte pluridisciplinaire **HAL**, est destinée au dépôt et à la diffusion de documents scientifiques de niveau recherche, publiés ou non, émanant des établissements d'enseignement et de recherche français ou étrangers, des laboratoires publics ou privés.

DE LA RECHERCHE À L'INDUSTRIE

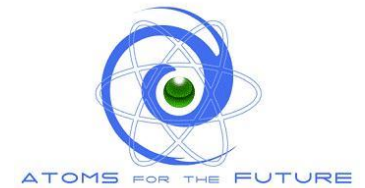

## NONLINEAR DYNAMICAL BEHAVIOR OF A FUEL PINS BUNDLE

Thomas CATTEROU

*Guided by :*

Victor BLANC (CEA)

Guillaume RICCIARDI (CEA)

Bruno COCHELIN (LMA)

Stéphane BOURGEOIS (LMA)

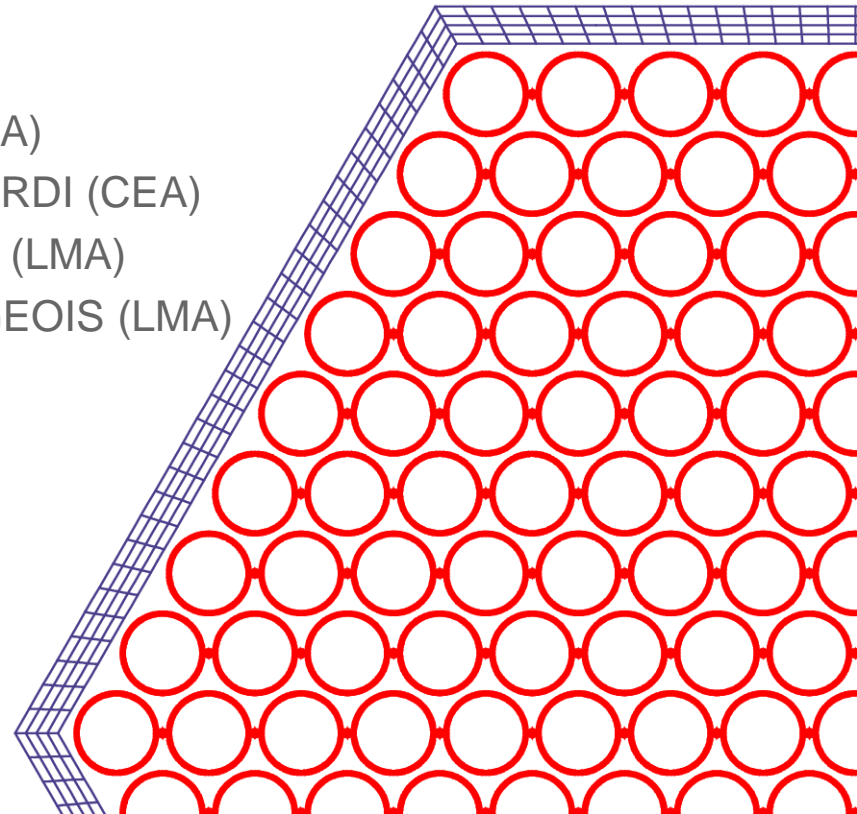

- ❑ An introduction to the Sodium Fast Reactor ASTRID
- ❑ State of the art
- ❑ Linear dynamic analysis of a fuel pins bundle
- ❑ Motivation and methodology of the study
- ❑ Non-linear behaviour, pins bundle with clearances
- ❑ Future applications

# ASTRID

*Advanced Sodium Technological Reactor  
for Industrial Demonstration*



- Technological demonstration reactor
- Gen IV system
  - Safety
    - Level at least equivalent to GEN III
    - Integrating FUKUSHIMA accident feedback
  - Durability
    - Close cycle of fuel
    - Pu multi recycling to preserve natural resources
  - Operability

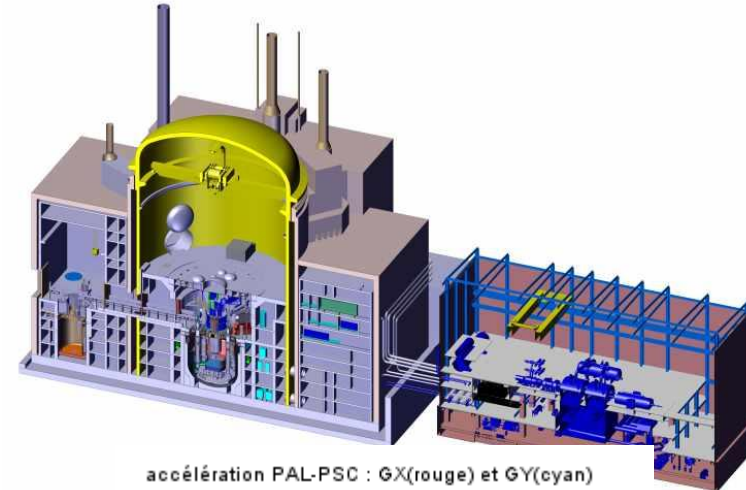

accélération PAL-PSC : GX(rouge) et GY(cyan)

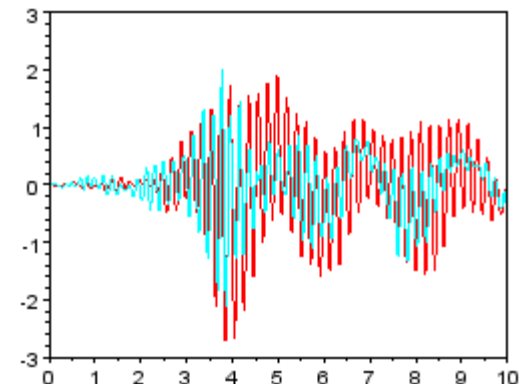

## Various scales of study

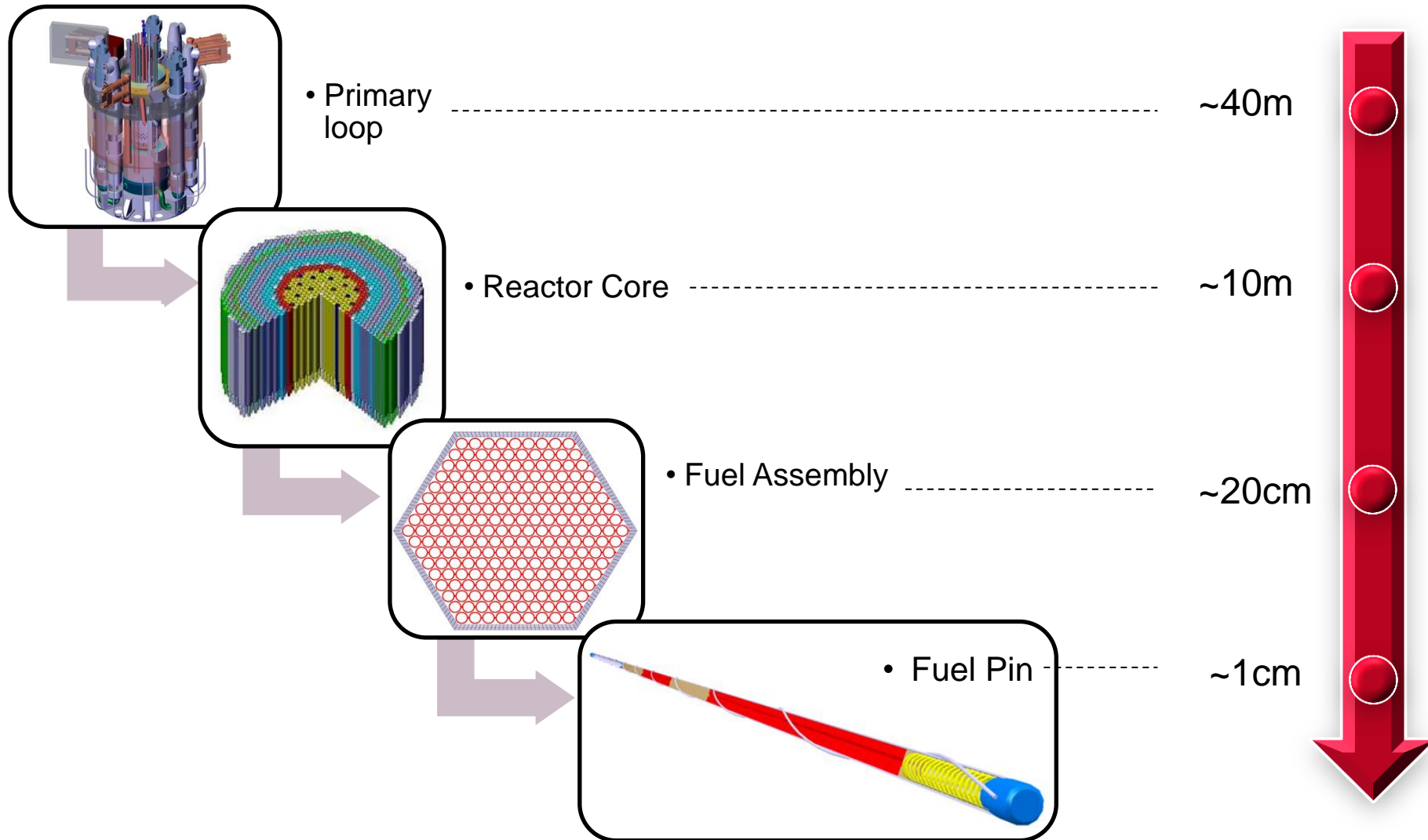

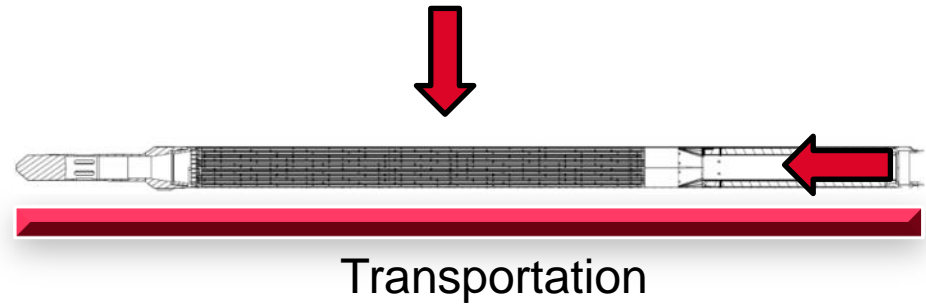
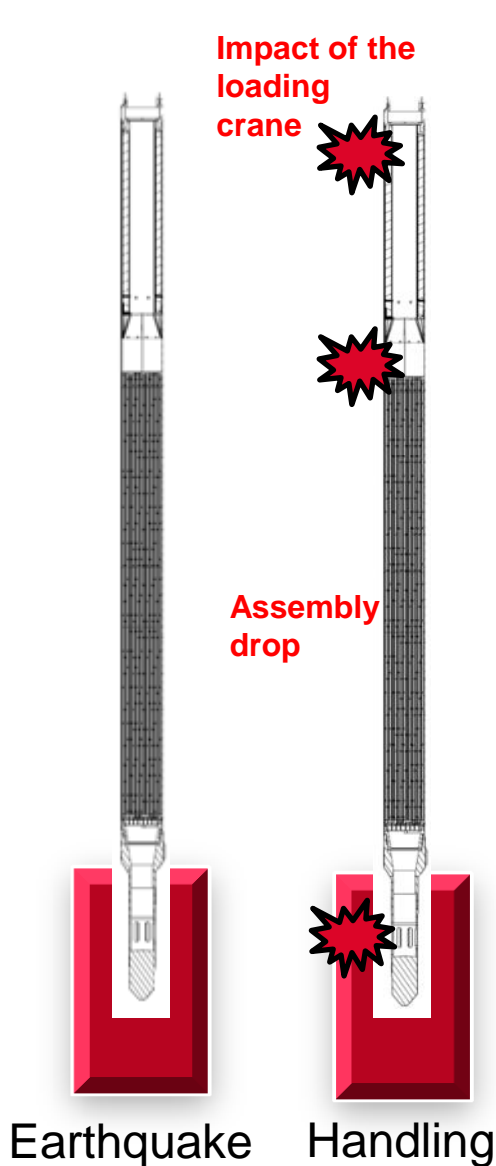

## Goals :

- To describe the dynamical behaviour of the fuel pins bundles with internal clearances
- To assess stresses in the pins induced by dynamic loads



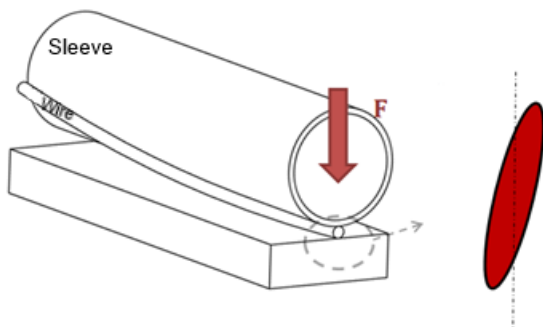
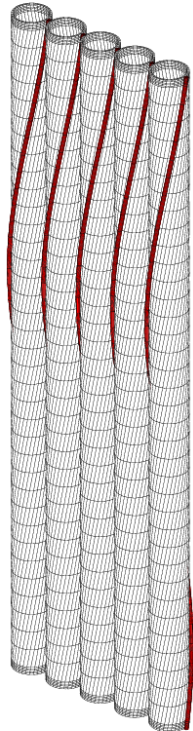

## Difficulties :

- To create a numerical models with a large amount of potentiel contact (~30000)
- Identify local stress in a tube from a beam calculation (sizing studies).
- Quick and accurate calculations...

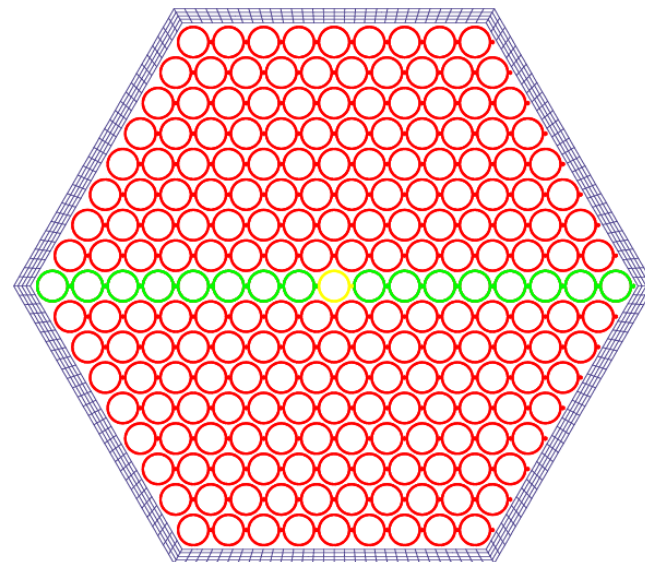



## ■ Progress in the field in the CEA

### ■ Moussalam[1], Broc [2].

*Seismic studies on Fast breeder reactor core*

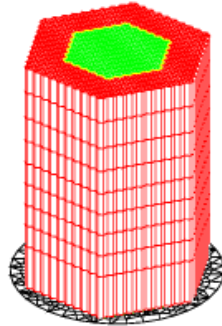

### ■ Vizcaino (2014)



*Review and study of the longest lines on one winding pitch*

### ■ DOMAJEUR2 / Bamboo Leturq (2015)

*Thermomechanic of the pins bundle*

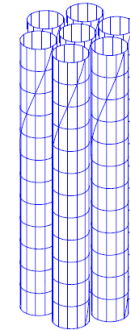

### ■ Catterou (2015)

*3D quadratic finite elements*

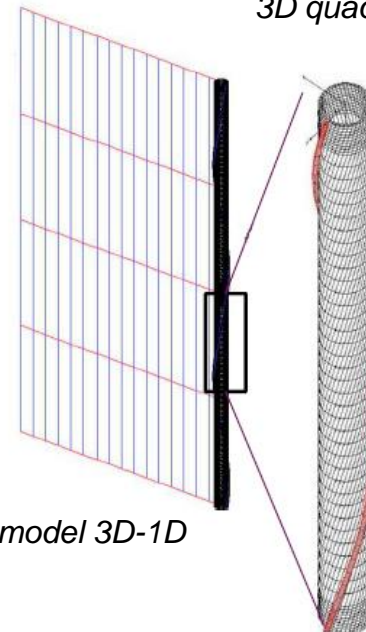

*Mixed model 3D-1D*

Maximum stress calculation but:

- Without clearance
- No impact effect
- Incomplete modelling of the fuel bundle.

[1] SMiRT21 (2011), "Industrial model for the dynamic behavior of [...] LMFBR core"

[2] SMiRT20 (2009), "Fluid Structure Interaction models for the dynamic behaviour of tube bundles [...]"



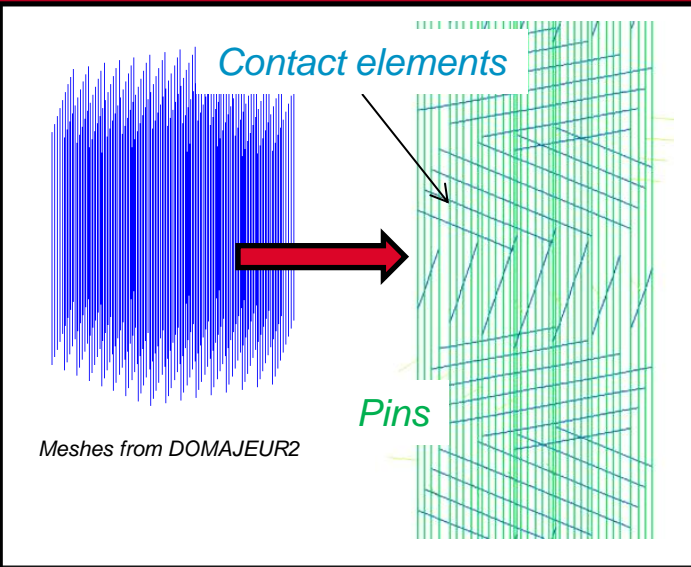

■ Dynamic analysis  
 Input : imposed acceleration on the first mode

### Maximum stress

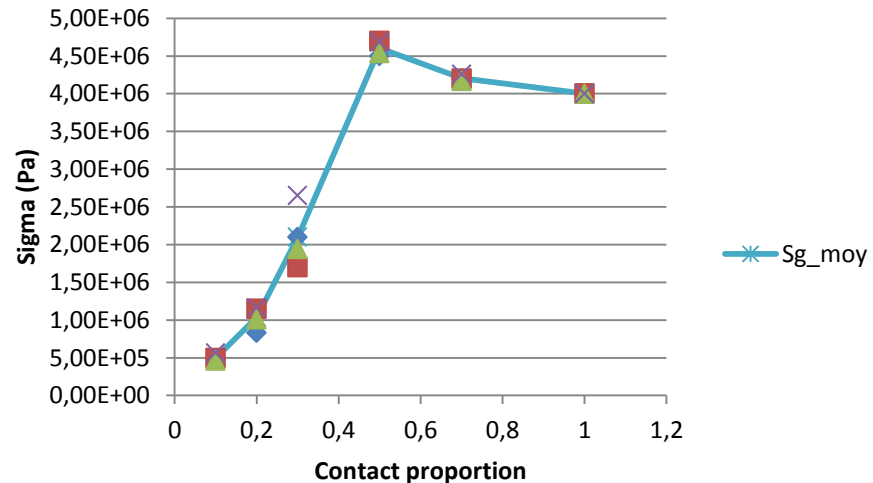

■ Modal analysis

Mode 1    Mode 2    Mode 3

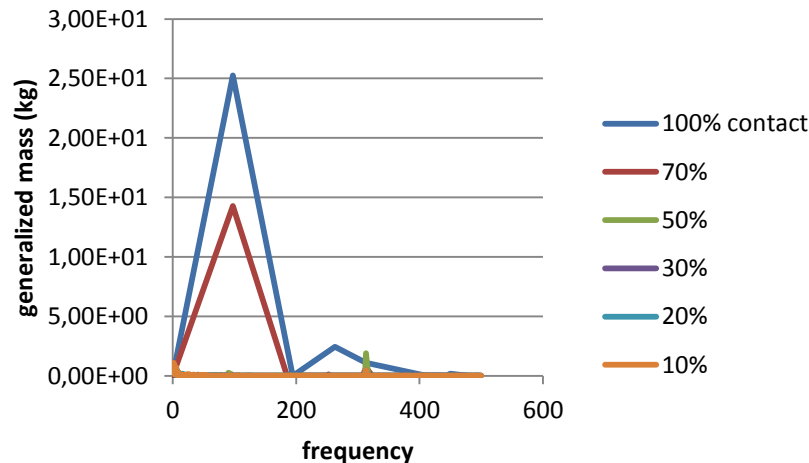
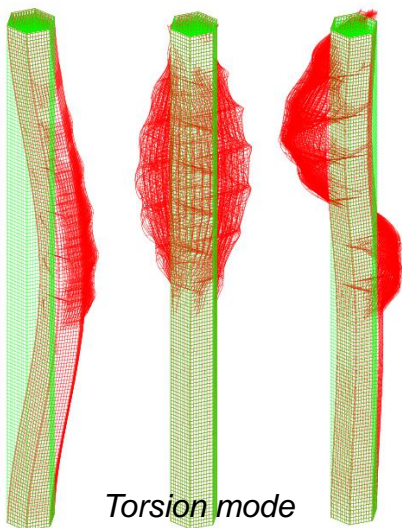

**Observations:**  
 Results are very dependant of the presence and the characterization of the contact elements.

■ Experimental equipment : BELIER (CEA)

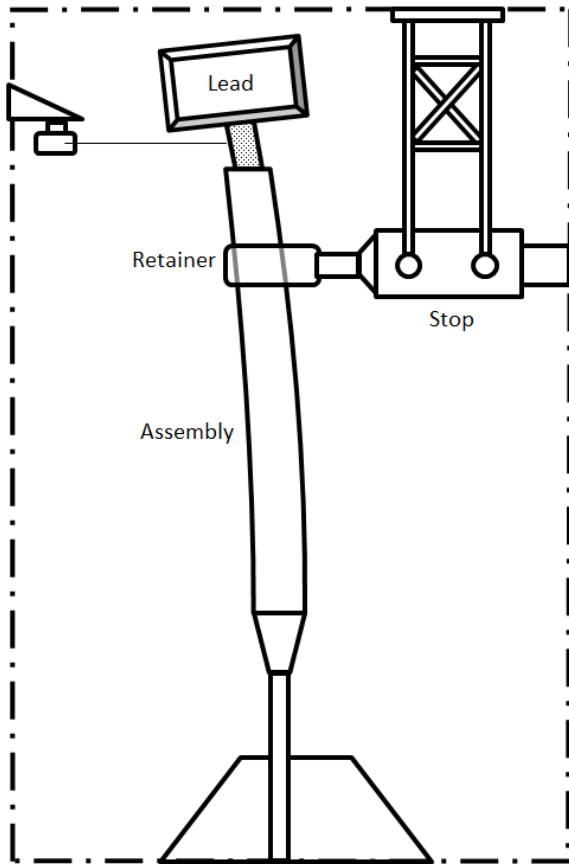

■ Tests in CEA Cadarache between 1989 and 1995

■ In air and in water

■ Homogeneous clearance or without clearance

■ Some instrumented pins on the height of the impact.

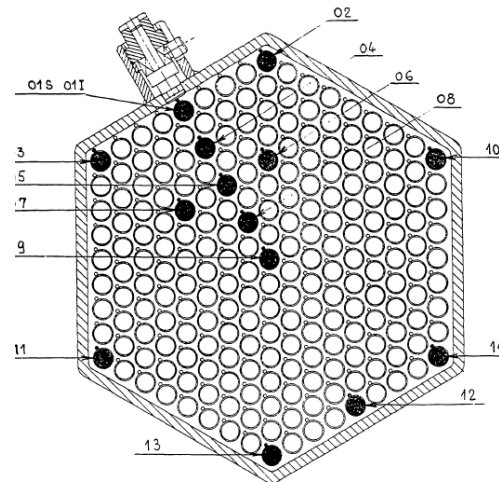

● *Instrumented pin*

## ■ Experimental equipment : BELIER (CEA)

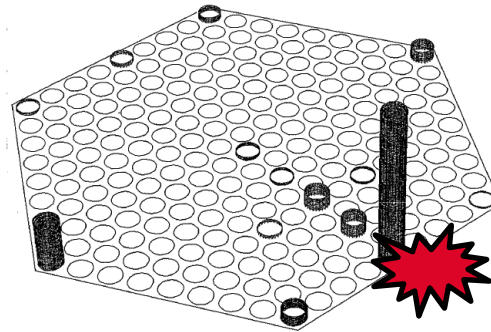
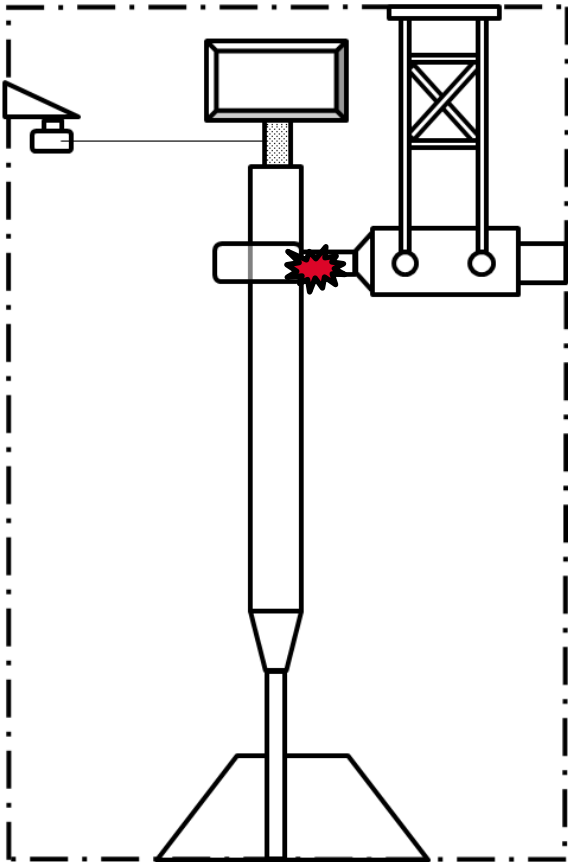

Pins bundle without clearances

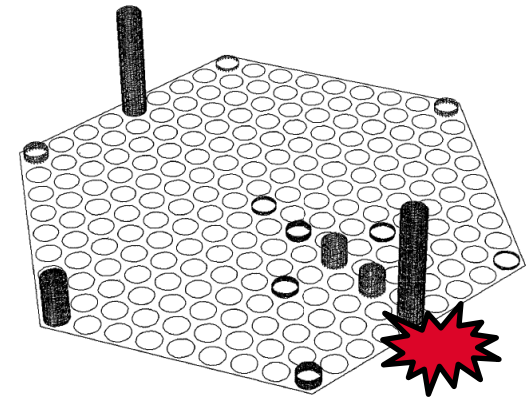

Pins bundle with homogeneous clearances

- Which is the most critical situation ?
- Are there particular clearance distributions which could be more harmful?

→ Necessity to model clearances in the bundle.

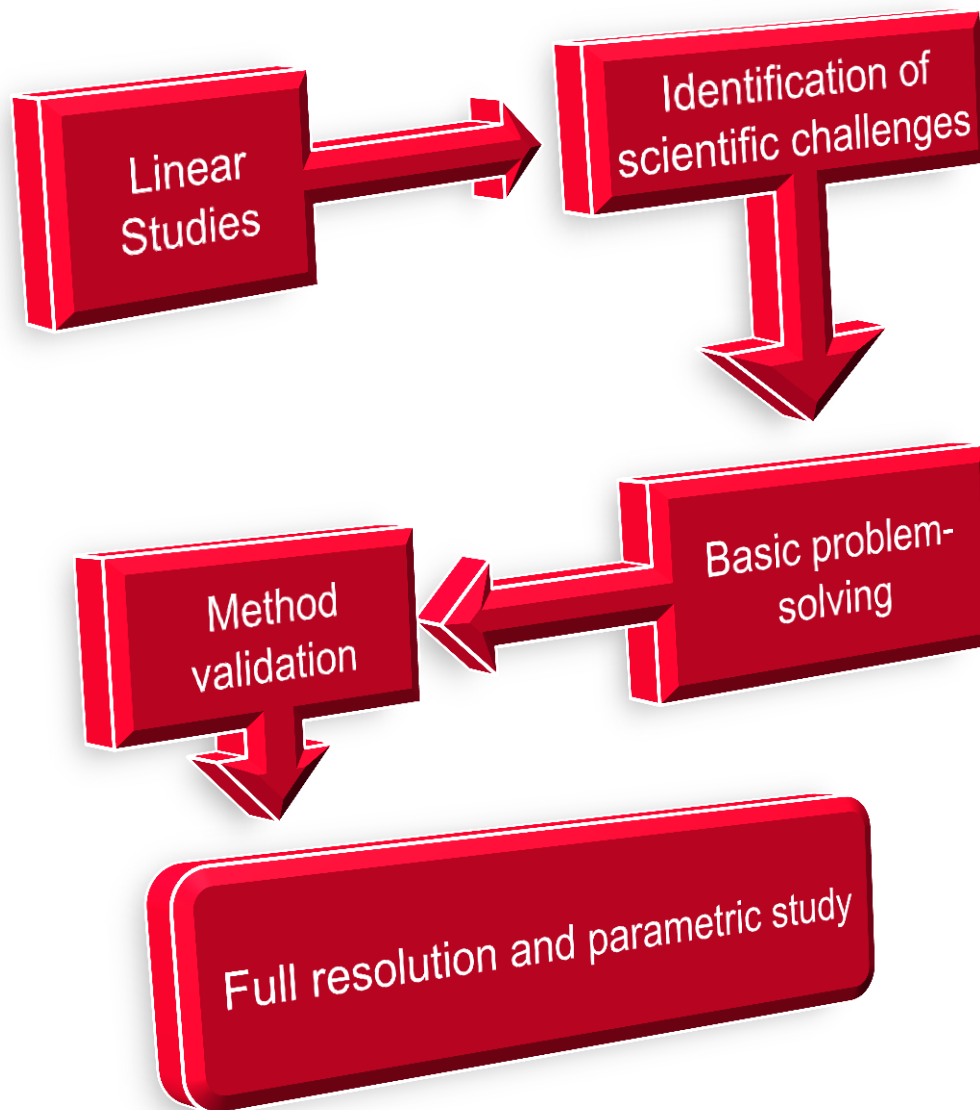

- Use of a mass-spring system  
**Aborted, bad simulation of the bending.**

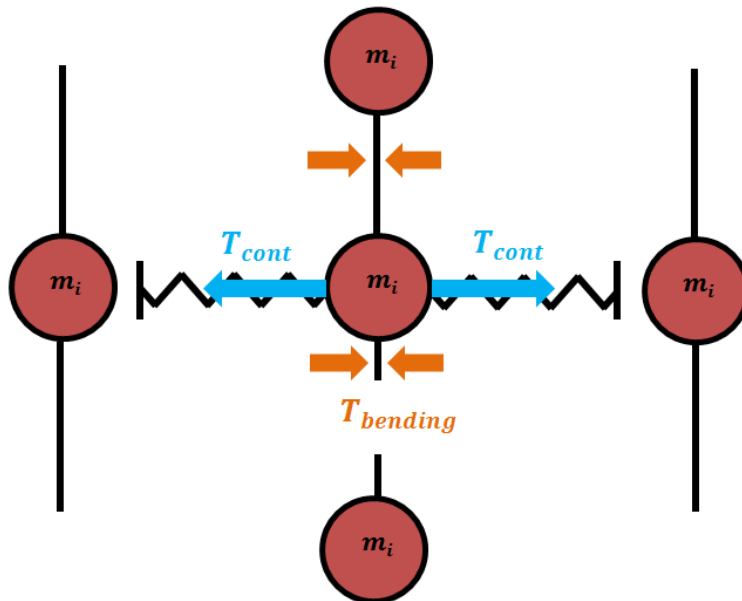
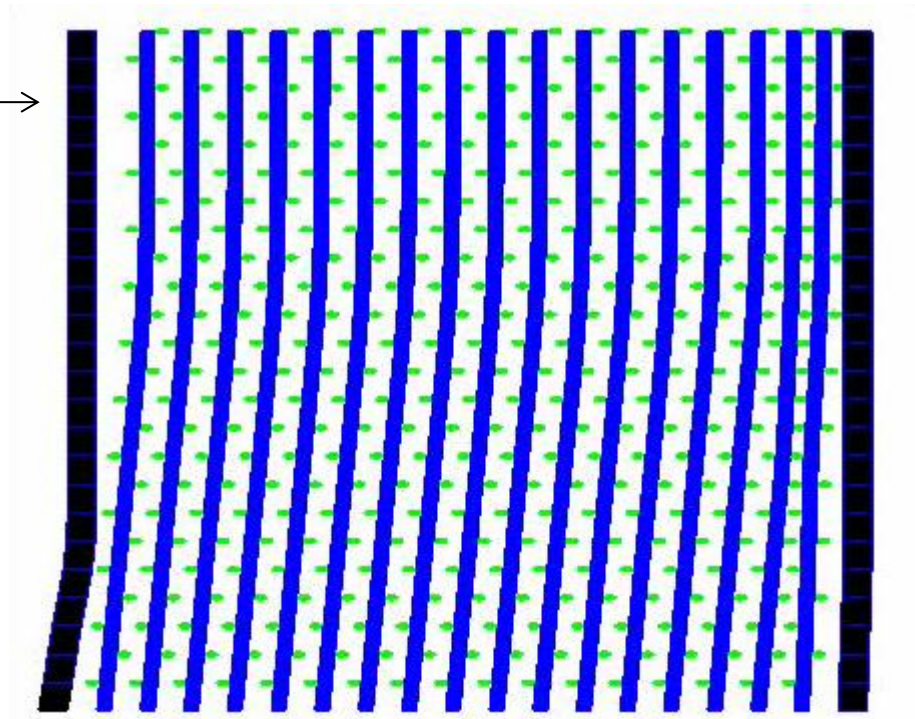
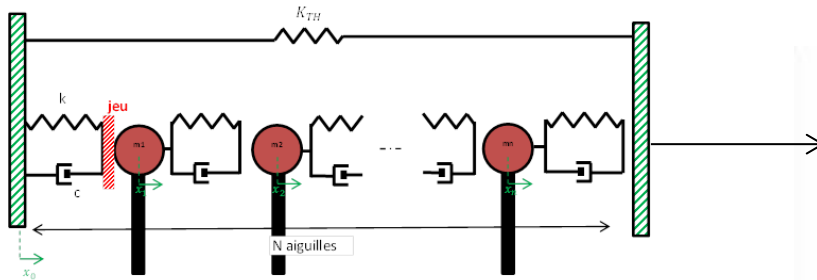

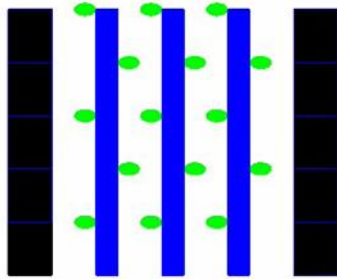

- Use of a mass-spring system  
**Aborted, bad simulation of the bending.**

- Resolution of an elementary problem analytically and with the finite element software CAST3M

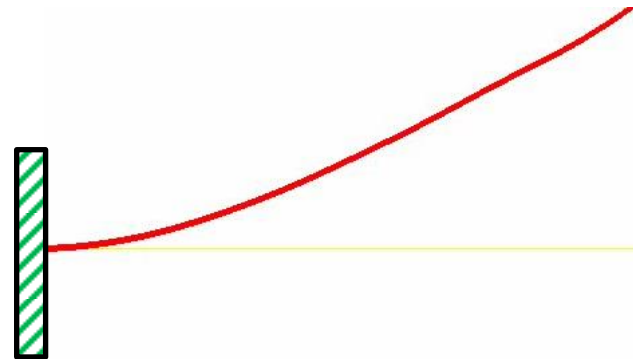
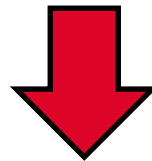

- Integration scheme approval
- Study on the influence of the contact moment search algorithm
- Determination of the stability barrier of the numerical solution

*Experimental calculation of the behavior of a pin in a transport configuration*



**To come**

- Calculation on a 2D then a 3D pin's beam.
- Statistical analysis of the influence of the repartition of clearances in the beam.
- Experimental validation

*Experimental calculation of the dynamic of a line of pins*

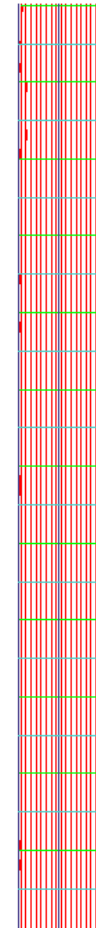



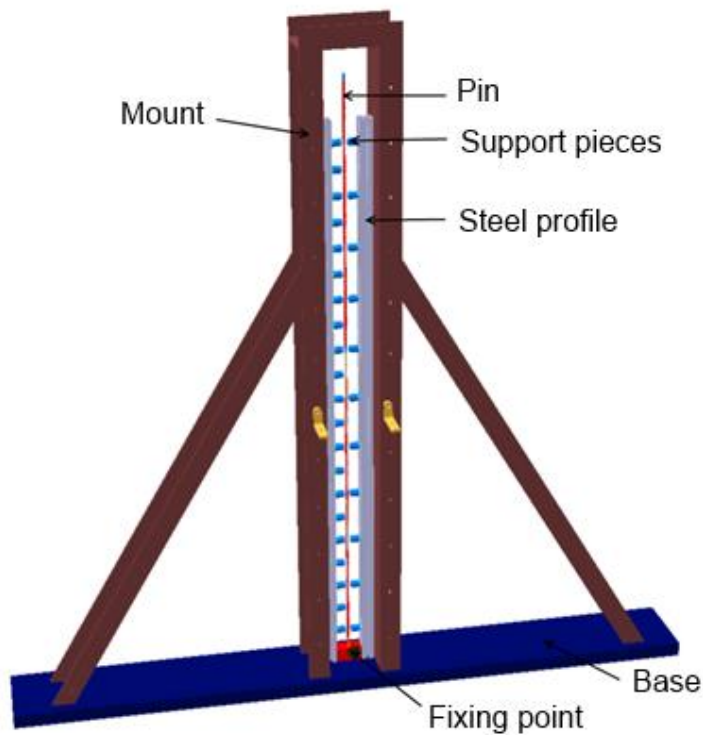

**CARNAC**

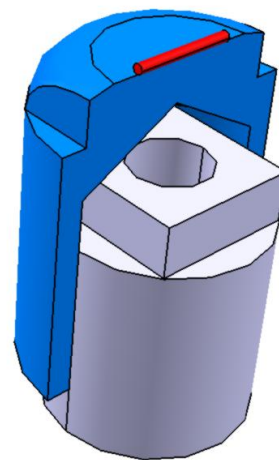

*Support pieces*

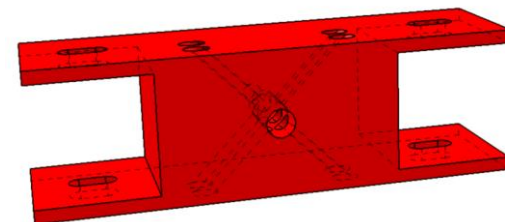

*Fixing point*

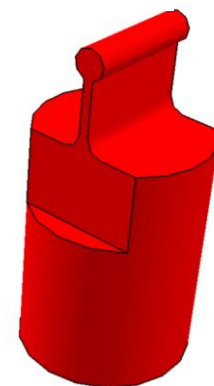

## Goals:

- To identify the influence of clearances on the dynamical behavior of one pin.
- To validate numerical model

- Small and numerous clearances in the pins beam influence strongly the dynamical behavior of the structure.
- Difficulty to estimate if a study without clearance is conservative or not.
- Some points must be examined carefully to ensure a right answer:
  - The integration scheme
  - The force law and the contact model
  - The estimation of the contact moment and period

- Integration scheme validation.
- Contact detection algorithm validation.
- 3D pins bundle model achievement.
- Statistical study of the impact of clearance and its repartition.

Thank you for  
your attention !

