



HAL
open science

Actinides separation chemistry in molten salts and its applications at the CEA

E. Mendes, J. Serp, D. Bengio, L. Diaz, D. Quaranta, G. Serve, M. Bertrand

► **To cite this version:**

E. Mendes, J. Serp, D. Bengio, L. Diaz, D. Quaranta, et al.. Actinides separation chemistry in molten salts and its applications at the CEA. Séminaire scientifique DRCP, Jun 2016, Bagnols Sur Cèze, France. cea-02439443

HAL Id: cea-02439443

<https://cea.hal.science/cea-02439443v1>

Submitted on 26 Feb 2020

HAL is a multi-disciplinary open access archive for the deposit and dissemination of scientific research documents, whether they are published or not. The documents may come from teaching and research institutions in France or abroad, or from public or private research centers.

L'archive ouverte pluridisciplinaire **HAL**, est destinée au dépôt et à la diffusion de documents scientifiques de niveau recherche, publiés ou non, émanant des établissements d'enseignement et de recherche français ou étrangers, des laboratoires publics ou privés.

Actinides separation chemistry in molten salts and its applications at the CEA

E. Mendes, J. Serp, D. Bengio, L. Diaz,
D. Quaranta, G. Serve, M. Bertrand

Nuclear Energy Division
Radiochemistry & Processes Department
Modelling and Separation Chemistry Service
Development of Separation Processes Laboratory

CEA Marcoule, Direction à l'énergie atomique,
Département radiochimie et procédés
Service modélisation et chimie des procédés de séparation



“Pyrochemistry” : High temperatures chemical reaction processes



Zeus or
Poseidon,
Athens National
museum.

Igneous metallurgy (→ pyrometallurgy): materials upgrading well-being for everyday life (art, stained glass windows and ...).

Weapons for defence... or conquest!

Pyrochemistry

- Molten salt chemistry
- Liquid metals chemistry

Pyrochemical reprocessing

Can be defined as: set of chemical separations and/or conversion processes avoiding aqueous media.

Pyrochemical processing is, generally, associated to the molten salts media, however molten salts are a sub-set of pyrochemistry.

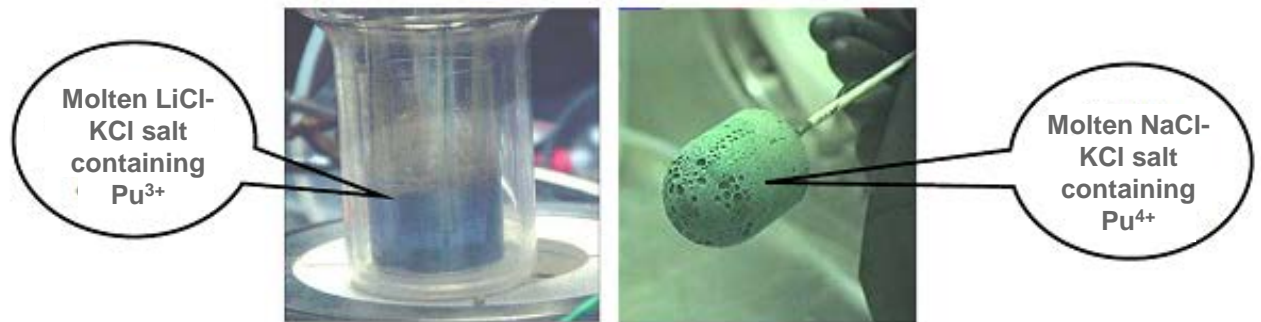

- High conductivity and large electrochemical window: well adapted for treatment of metallic fuels. ▶
- Radiation resistance: treatment of high burn-up fuels, or shorter cooling time of spent fuel.
- Simplified management of criticality: compact installations.
- Processes essential for treatment of MSR fuels

Molten salts: ionic liquids

- Non ideal behaviour liquids: notion of **activity** must be considered.

*Activity: active concentration. Electrostatic interaction between different species decrease their reactivity potential, thus the concentration must be corrected by introducing an **activity coefficient**.*

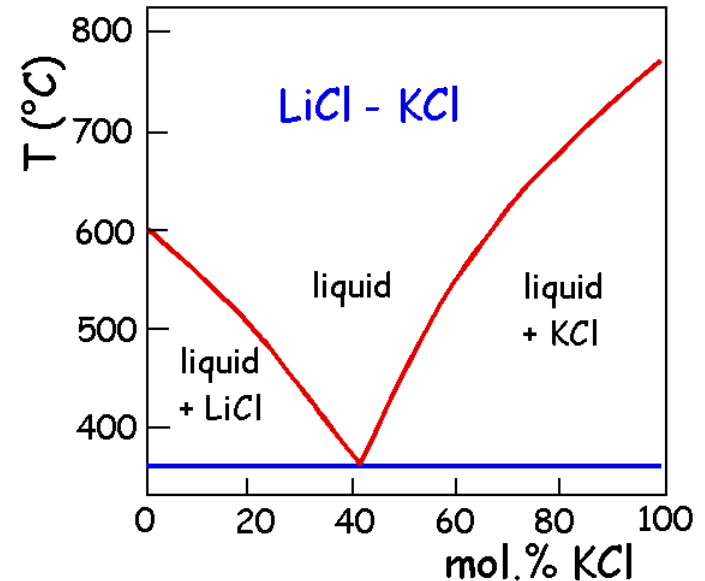

- Largely used.
- Eutectic mixture
352°C (41 mol% KCl)
- Working temperature range: 400- 550°C
- Anodic limitation: chlorine
- Cathodic limitation: lithium
- Electrochemical window: 3.6 V

Two laboratories dedicated to molten salt chemistry in the Radiochemistry & Processes Department

Inactive laboratory

- Two gloveboxes under argon + three fume cupboards
- Electrochemistry studies (CV, OCP...), TGA



ZIP,
CHIMENE

Alpha laboratory

- Four gloveboxes (under Air or N₂ inert atmosphere)
- Analysis : fluorescence X, alpha and gamma spectrométrie , electrochemical studies, in-situ monitoring: LIBS

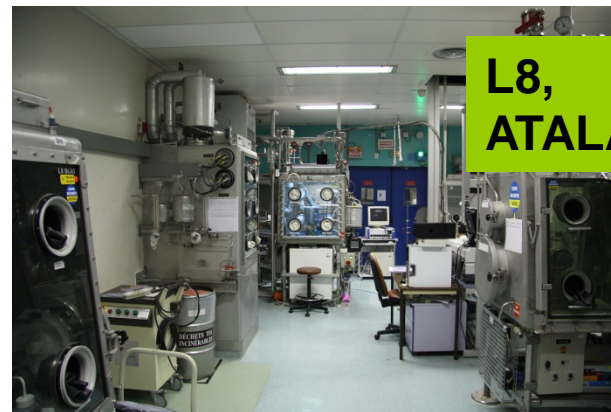

L8,
ATALANTE

R&D:

Fundamental and applied studies on pyrochemical separation processes

Three main separation processes:

Precipitation – role of oxoacidity

Electrochemical processes – electrorefining, electrolywinning

Reductive **liquid-liquid extraction**

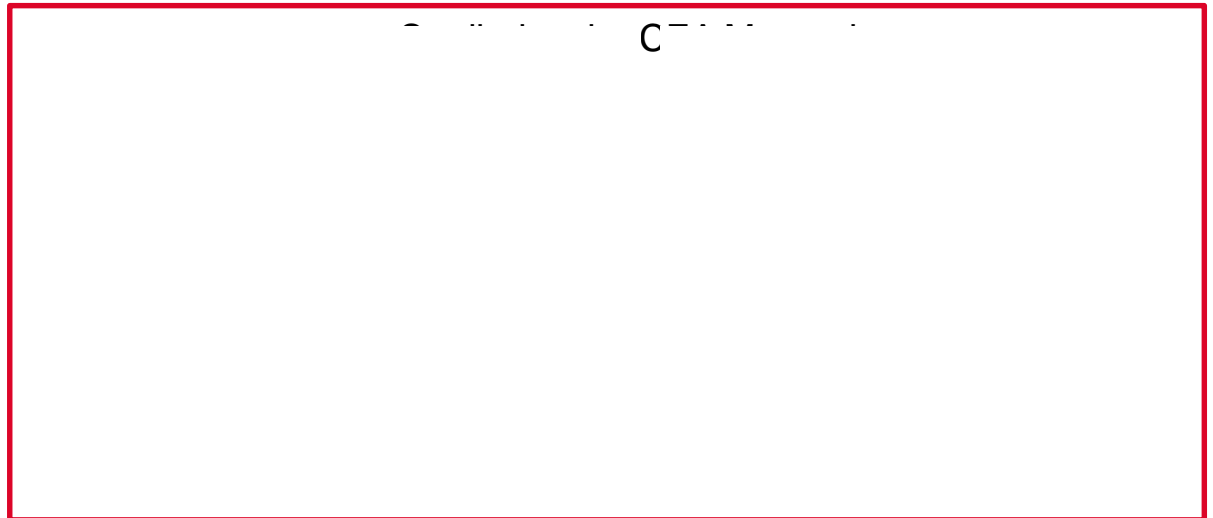

➤ AIDA-Mox process

Conversion of military Pu into non military PuO₂

- Starting alloy: Pu, Ga (<5 wt%) and ²⁴¹Am (<1 wt%) (coming from ²⁴¹Pu activity)
- NaCl-KCl salt at 700°C

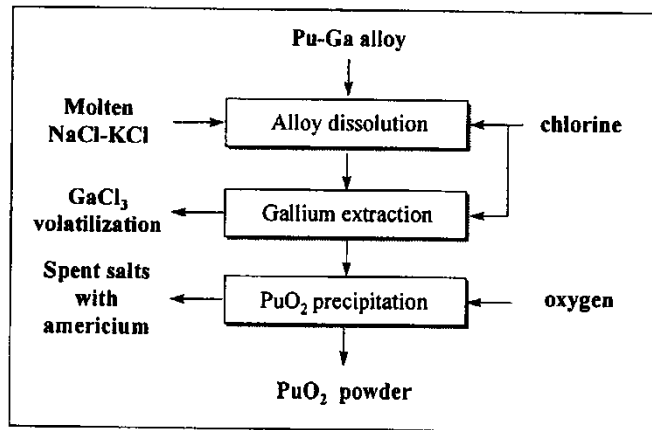
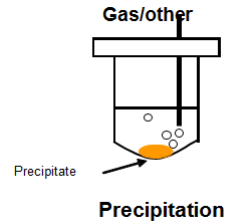
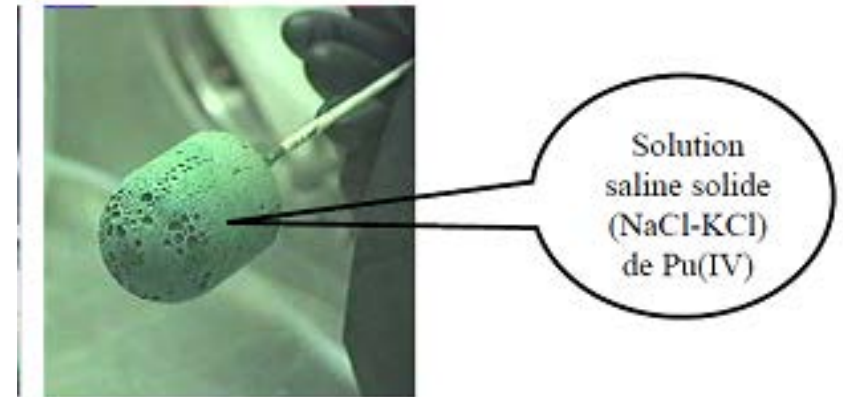
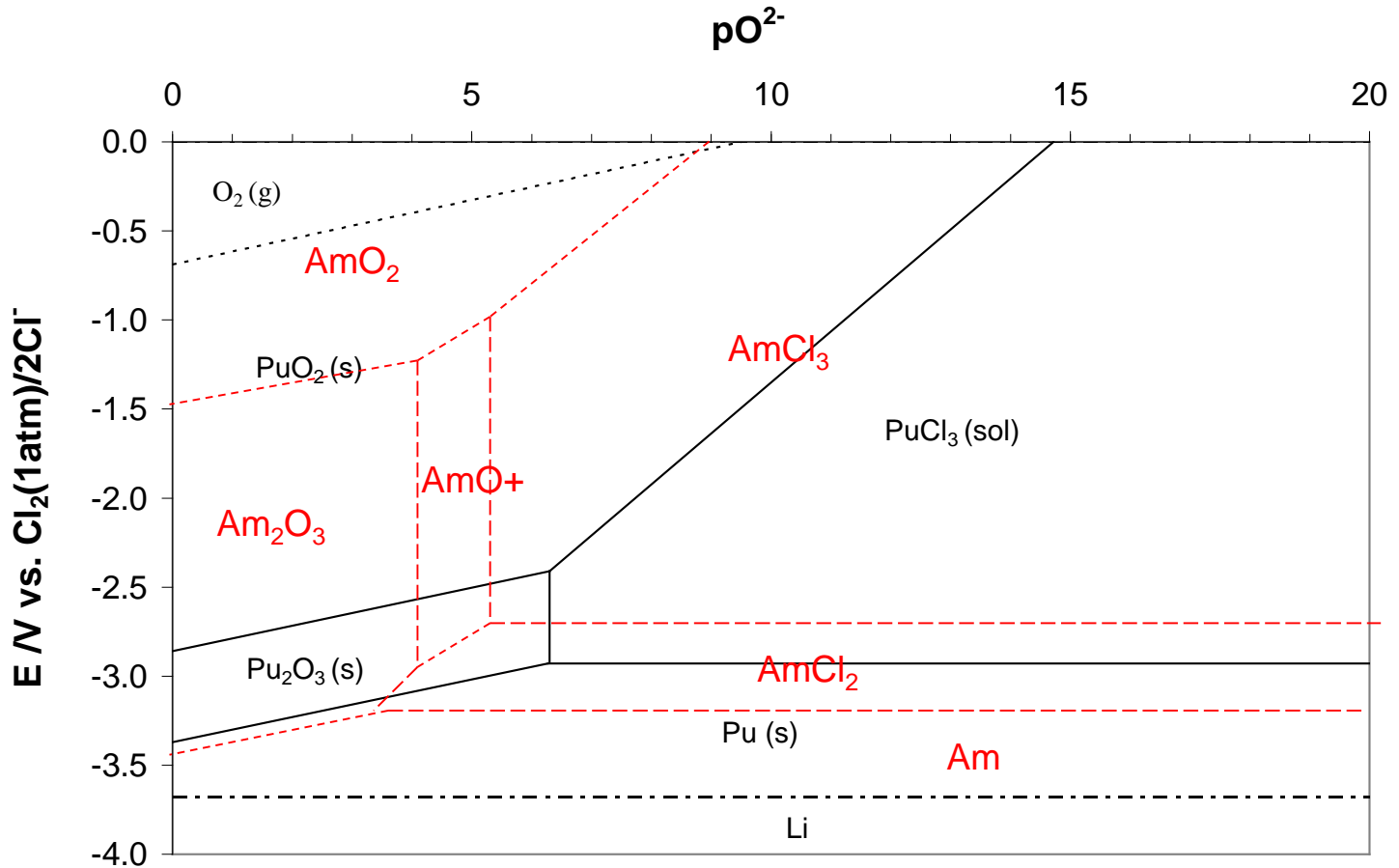

Figure 1 : Pyrochemical conversion of Pu-Ga alloy into PuO₂



A.G. Osipenko et al, Molten Salt Forum, vol.5-6, 553 (1997)

- Alloy chlorination: Pu(IV), Am(III), GaCl₃ volatile
- Selective precipitation of PuO₂ by bubbling O_{2(g)}, Am(III) remains soluble



E- $p\text{O}^{2-}$ Diagram of Pu in LiCl-KCl at 450°C, $[\text{Pu}(\text{III})]=0.01\text{mol/kg}$, et à 0.001mol/kg pour l'Am

Pu: C. Caravaca et al., *J. Nucl. Mat.*, 377, 340 (2008), Am: D. Lambertin et al., *Plasma and ions.*, 3, 65-72 (2000)

Separation processes in molten salts

Three main separation processes:

Precipitation – role of oxoacidity

Electrochemical processes – electrorefining, electrolywinning

Reductive liquid-liquid extraction

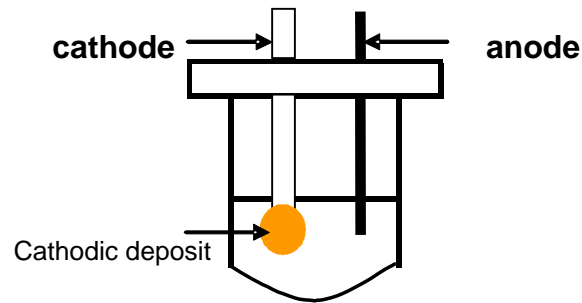

Electrodeposition

Industrial uses of molten salts

Aluminium production ~24 Mt/year

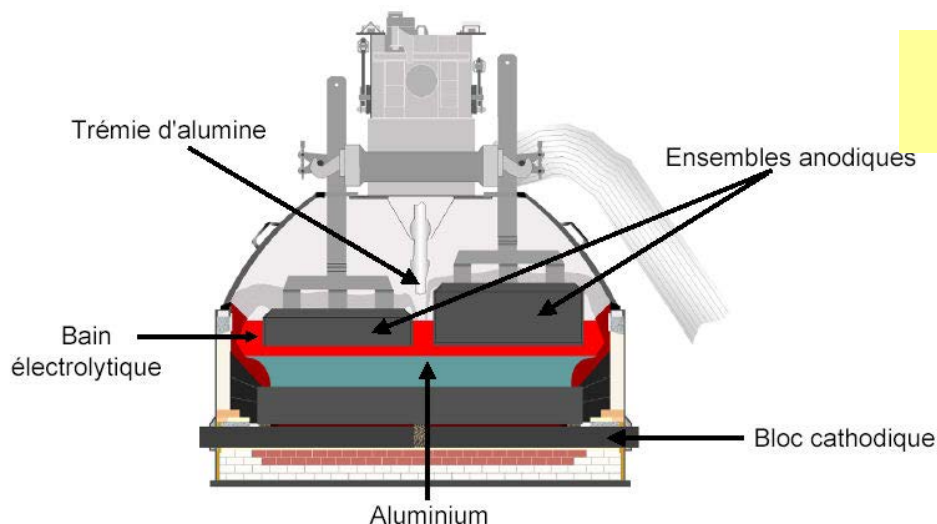

Alumina Electrolysis in molten cryolite
(Na_3AlF_6) at 950°C

Pool AP30 (Alcan) : 14m length, ~300kA,
Far. Yield = 96%, 2,3t/d

Alkali Metals sodium ~ 100 kt/year

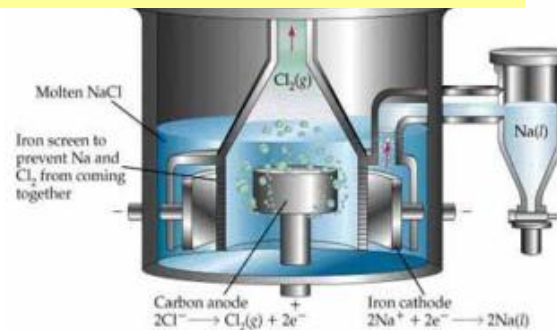

Electrolysis of alkali chlorides.
Ex: production of sodium at 600°C
($2\text{NaCl} = 2\text{Na} + \text{Cl}_2$)

Pool Down : charge 8t, 45 kA,
Far. yield = 90%, 0,8t/j (Na), 1,3t/j (Cl_2)

F_2 production ~ 1,5 kt/year



Electrolysis of 2HF , KF at
 -85 - 105°C
($2\text{HF}_{liq} = \text{H}_2 + \text{F}_2$)

Monel pool: porous
carbone anode, steel
cathode, 6 kA,
Far. yield = 90-95%, 4kg/h
(F_2)

Other metals (Mg, Ca, Li, Zr...)

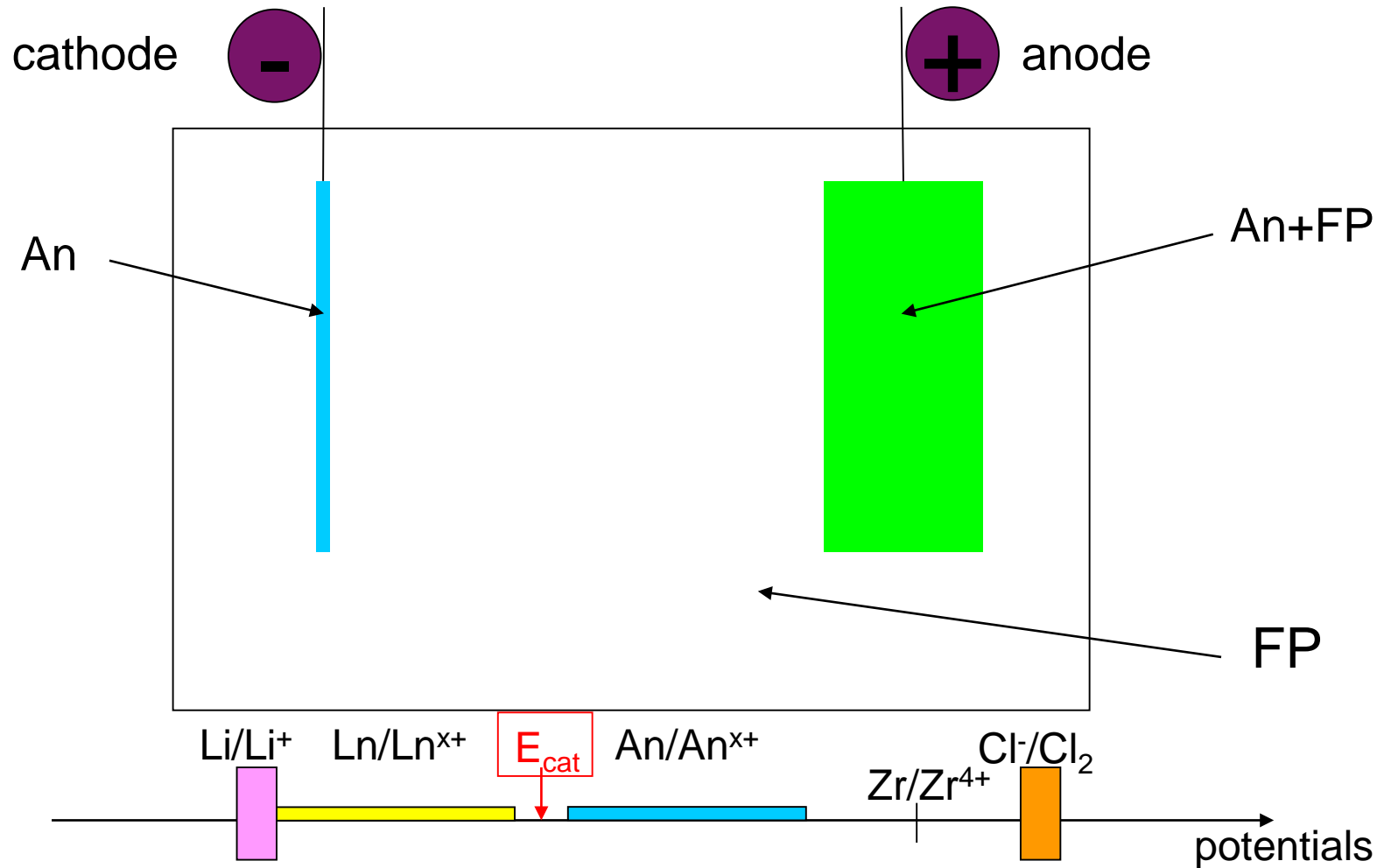

- Purification process: anodic dissolution of impure metal and cathodic deposition of purified metal

Nuclear applications: Reprocessing of metallic fuels



EBR-II

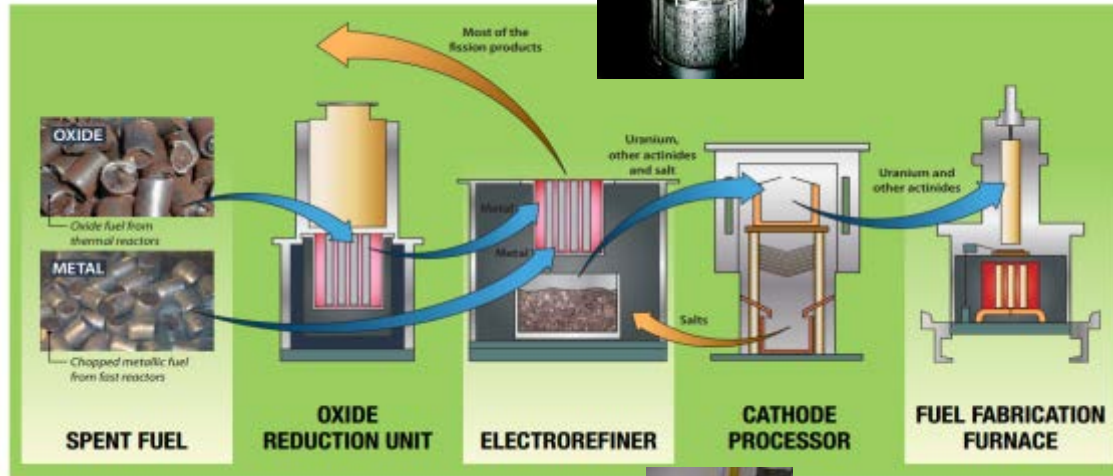

U deposit



Purified metal



Source: ANL website
<http://www.ne.anl.gov>

- Most adapted process for metallic fuel recycling (US, Japan, South Korea, Russia, India)
- Analogue process for nitride fuels (Japan, Russia)

Table I. Inventory of Spent Fuel Designated for Pyroprocessing at INL.

Fuel Type	EBR-II Driver (MTHM)	FFTF Driver (MTHM)	EBR-II Blanket (MTHM)	Total (MTHM)
Initial Fuel in June 1996	3.1	0.25	22.4	25.75
Fuel Treated as of January 2012	0.8	0.22	3.6	4.62
Remaining Untreated Fuel	2.3	0.03	18.8	21.13

Electrochemical processes

■ Nernst equation, equilibrium



$$E_{eq}(\text{An}^{n+} / \text{An}) = E^\circ(\text{An}^{n+} / \text{An}) + \frac{2.3RT}{nF} \log\left(\frac{a(\text{An}^{n+})}{a(\text{An})}\right)$$

$$E_{eq}(\text{An}^{n+} / \text{An}) = E^\circ(\text{An}^{n+} / \text{An}) + \frac{2.3RT}{nF} \log\left(\frac{\gamma_{\text{An}^{n+}}}{\gamma_{\text{An}}}\right) + \frac{2.3RT}{nF} \log\left(\frac{x_{\text{An}^{n+}}}{x_{\text{An}}}\right)$$

– Use of inert solid electrode (deposition of pure An, $a(\text{An})=1$)

$$E_{eq}(\text{An}^{n+} / \text{An}) = E^\circ(\text{An}^{n+} / \text{An}) + \frac{2.3RT}{nF} \log(\gamma_{\text{An}^{n+}}) + \frac{2.3RT}{nF} \log(x_{\text{An}^{n+}})$$

$$= E'^\circ(\text{An}^{n+} / \text{An}) + \frac{2.3RT}{nF} \log(x_{\text{An}^{n+}})$$

\Rightarrow E'° apparent standard potential
Determined by electrochemical measurements

An/Ln separation
depends on ΔE

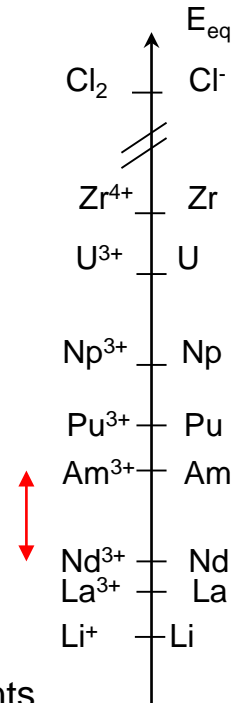

↪ **Electrodeposition of metal: more cathodic potential compared to E_{eq} (= more negative than E_{eq})**

An/Ln Electroseparation: $\Delta E_{An/Ln} = E_{An^{n+}/An} - E_{Ln^{n+}/Ln}$

On inert electrode

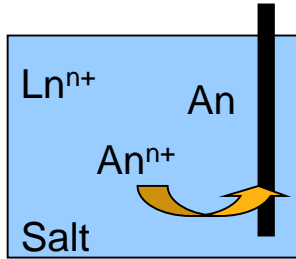

↳ Pure An deposit

On non-inert electrode

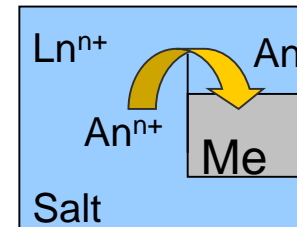

↳ Deposition of solubilised in metal or intermetallic formation

$$\Delta E_{An/Ln} = \Delta E^{\circ}_{An/Ln} + \frac{2,3RT}{nF} \log \left(\frac{x_{An^{n+}} \cdot x_{Ln(Me)}}{x_{Ln^{n+}} \cdot x_{An(Me)}} \right) + \frac{2,3RT}{nF} \log \left(\frac{\gamma_{An^{n+}}}{\gamma_{Ln^{n+}}} \right) + \frac{2,3RT}{nF} \log \left(\frac{\gamma_{Ln(Me)}}{\gamma_{An(Me)}} \right)$$

Thermo data
(pure comp.)

Evolution of
concentrations

Activity
coef.
in salt
Ratio ~1

Activity
Coef.
In Metallic
solvent



- γ ratio in metal may be very important



- **Determination of activity coefficient in metal**

- Galvanic Cell: $An \mid \text{molten salt, } AnCl_3 \mid An_{(Me)}$



LiCl-KCl-PuCl₃, Bi electrode at 500°C

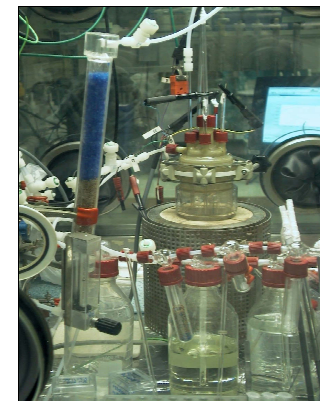
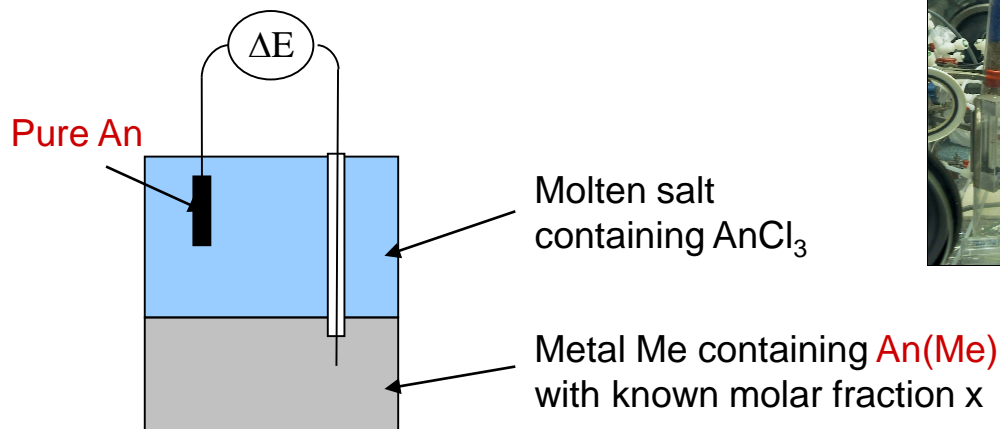

Electromotive force (e.m.f.) :

$$f.e.m = E_{An} - E_{An(Me)} = \frac{2.303RT}{nF} \log(\gamma_{An(Me)}) + \frac{2.303RT}{nF} \log(x_{An(Me)})$$

↳ e.m.f. = f(log x_{An(Me)})

→ log γ_{An(Me)}

→ Number of exchanged electrons

↳ **Measurement does not depend on electrolyte**

Inert cathode / reactive cathode

- Inert
- Liquid cathode: solubilisation of An in metal
- Solid reactive cathode: intermetallic formation

$$\gamma_{An} = 1$$

$$\gamma_{An} \neq 1 \text{ (Cd, Bi)}$$

$$a_{An} \neq 1$$

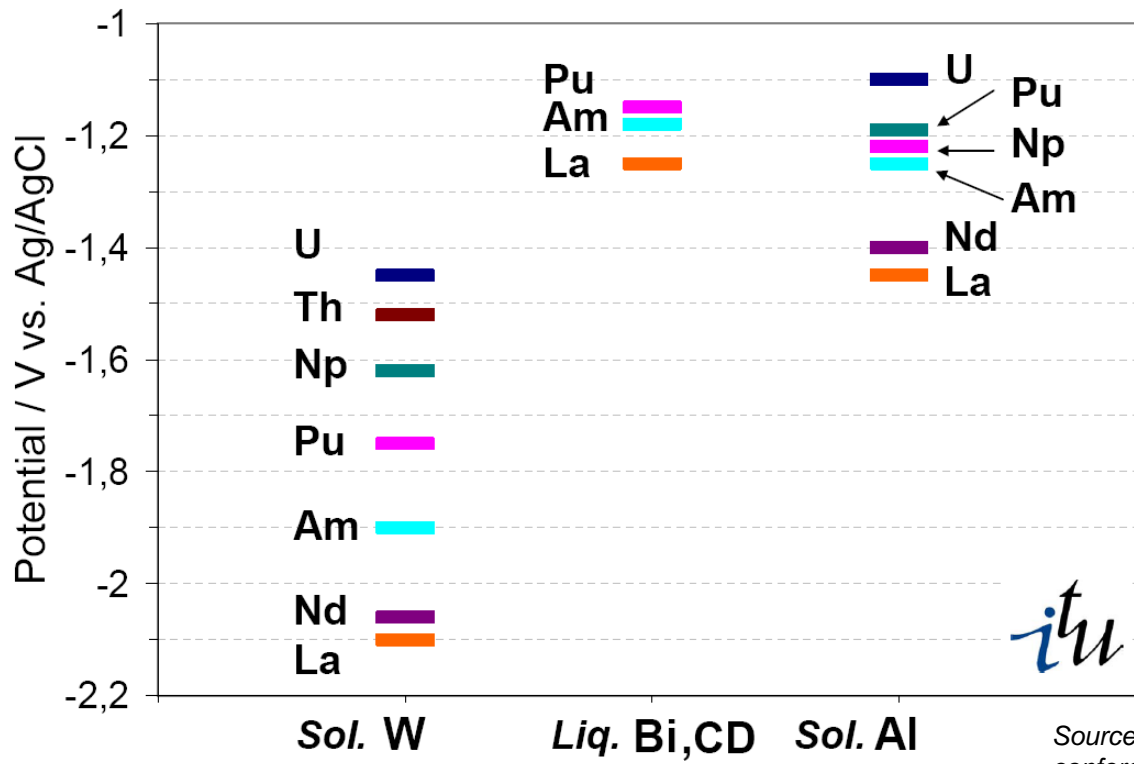

Example : $\log \gamma(\text{Pu}_{(\text{Bi})}) = -8,7$ at 550°C

Inert cathode: high An/Ln separation, but deposit may be difficult to stabilise on cathode

Liquid cathode: lower separation but stabilisation of species in liquid metal.

Source: J.P. Glatz, Atalante conference 2008



Exhaustive electrolysis or electrowinning (FP7 - SACSESS)

Key step of the process: salt coming from E. ref step still contain An

→ **Necessity to recover these An**

- **First electrolysis realised on simulated electrorefining salt baths**

Anode → production of $Cl_{2(g)}$

(first tests on lanthanides at the inactive laboratory)

- **Understanding of the electrolysis behaviour:**

- determination of faradic yields, characterisation of the obtained deposit at the cathode,
- optimisation of Cl_2 producing anode,
- influence of the cathode material (Al, Mo)

- **Active tests on salts containing actinides (Pu) and lanthanides (Ce)**

→ **An/Ln Separation**

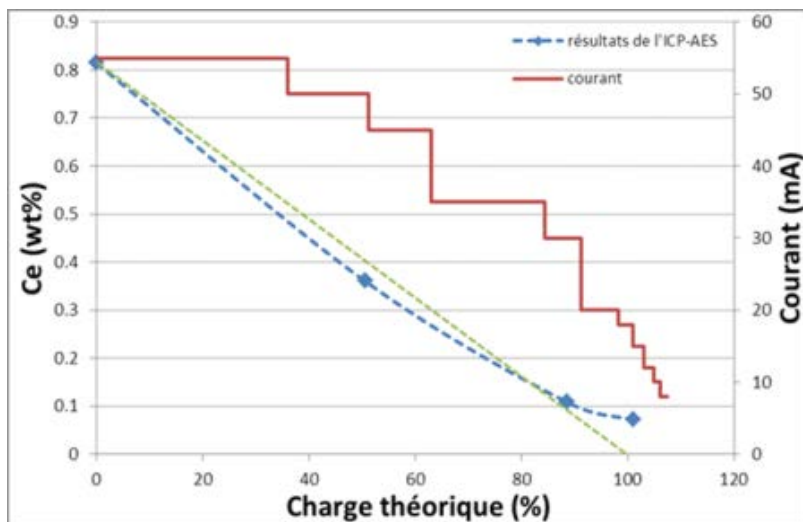
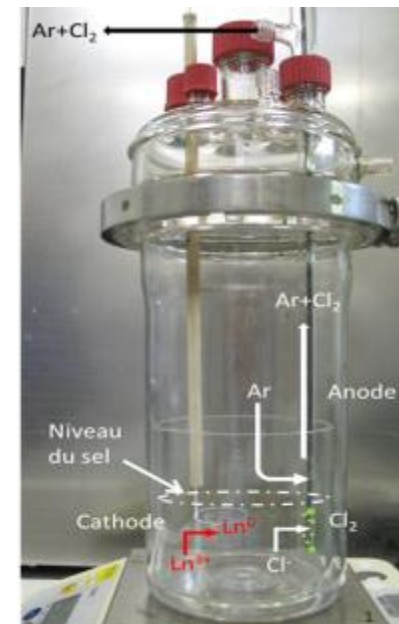

Separation processes in molten salts

Three main separation processes:

Precipitation – role of oxoacidity

Electrochemical processes – electrorefining, electrolywinning

Reductive **liquid-liquid extraction**

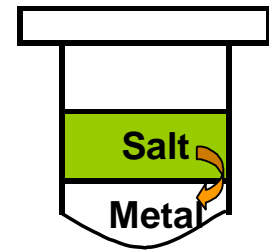

Liquid-liquid extraction

Principe

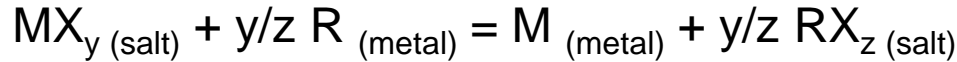

R: reductive **metal** dissolved in a **Metallic solvent**

$$K = \frac{a_M a_{RX_z}^{y/z}}{a_{MX_y} a_R^{y/z}} \quad \begin{cases} a_{\text{Salt}} = X_{\text{Salt}} * \gamma_{\text{Salt}} \\ a_{\text{MS}} = X_{\text{MS}} * \gamma_{\text{MS}} \end{cases}$$

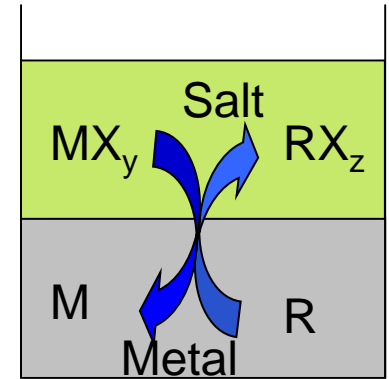

- Important parameters:

- Distribution coefficient $D_M = x_{M(\text{metal})} / x_{MX_y(\text{salt})}$
- Separation Factor $SF_{M/M'} = D_M / D_{M'}$

- Example : $\text{PuF}_3 + 3\text{Li}_{(\text{Bi})} = \text{Pu}_{(\text{Bi})} + 3\text{LiF}$

$$D_{\text{Pu}} = x_{\text{Pu}(\text{Bi})} / x_{\text{PuF}_3}$$

$$S_{\text{Pu}/\text{Nd}} = D_{\text{Pu}} / D_{\text{Nd}}$$

In general, **molar fractions (thermo)**
or **wt% (exp.)**

Example

- Pu/Nd separation by Al, in LiF-AlF₃

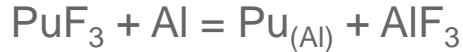

$$K_{\text{Pu}} = \frac{a_{\text{Pu}(\text{Al})} a_{\text{AlF}_3}}{a_{\text{PuF}_3} a_{\text{Al}}} = \frac{\gamma_{\text{Pu}(\text{Al})} \cdot x_{\text{Pu}(\text{Al})} \cdot \gamma_{\text{AlF}_3} \cdot x_{\text{AlF}_3}}{\gamma_{\text{PuF}_3} \cdot x_{\text{PuF}_3}}$$

$$D_{\text{Pu}} = \frac{x_{\text{Pu}(\text{Al})}}{x_{\text{PuF}_3}}$$

- Nd: NdF₃ + Al = Nd_(Al) + AlF₃

$$K_{\text{Nd}} = \frac{a_{\text{Nd}(\text{Al})} a_{\text{AlF}_3}}{a_{\text{NdF}_3} a_{\text{Al}}} = \frac{\gamma_{\text{Nd}(\text{Al})} \cdot x_{\text{Nd}(\text{Al})} \cdot \gamma_{\text{AlF}_3} \cdot x_{\text{AlF}_3}}{\gamma_{\text{NdF}_3} \cdot x_{\text{NdF}_3}}$$

$$D_{\text{Nd}} = \frac{x_{\text{Nd}(\text{Al})}}{x_{\text{NdF}_3}}$$

- Separation factor can be expressed from previous equations:

$$SF_{\text{Pu/Nd}} = \frac{D_{\text{Pu}}}{D_{\text{Nd}}}$$

$$\log SF_{\text{Pu/Nd}} = \log \left(\frac{K_{\text{Pu}}}{K_{\text{Nd}}} \right) + \log \left(\frac{\gamma_{\text{Pu}^{3+}}}{\gamma_{\text{Nd}^{3+}}} \right) + \log \left(\frac{\gamma_{\text{Nd}(\text{Al})}}{\gamma_{\text{Pu}(\text{Al})}} \right)$$

Electrolysis

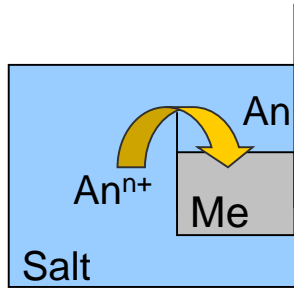

Liquid / liquid extraction

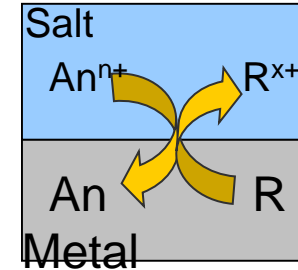
Electrolysis

$$\Delta E_{An/Ln} = \Delta E^{\circ}_{An/Ln} + \frac{2,3RT}{nF} \log \left(\frac{x_{An^{n+}} \cdot x_{Ln(Me)}}{x_{Ln^{n+}} \cdot x_{An(Me)}} \right) + \frac{2,3RT}{nF} \log \left(\frac{\gamma_{An^{n+}}}{\gamma_{Ln^{n+}}} \right) + \frac{2,3RT}{nF} \log \left(\frac{\gamma_{Ln(Me)}}{\gamma_{An(Me)}} \right)$$

Extraction

$$\log SF_{An/Ln} = \log \left(\frac{K_{An}}{K_{Ln}} \right) + \log \left(\frac{\gamma_{An^{n+}}}{\gamma_{Ln^{n+}}} \right) + \log \left(\frac{\gamma_{Ln(Me)}}{\gamma_{An(Me)}} \right)$$

Thermo. data
(pure comp.)

Activity coefficients
Salt

Activity coefficients
Metal

- Pu/Ce Separation– activity coefficient dependency

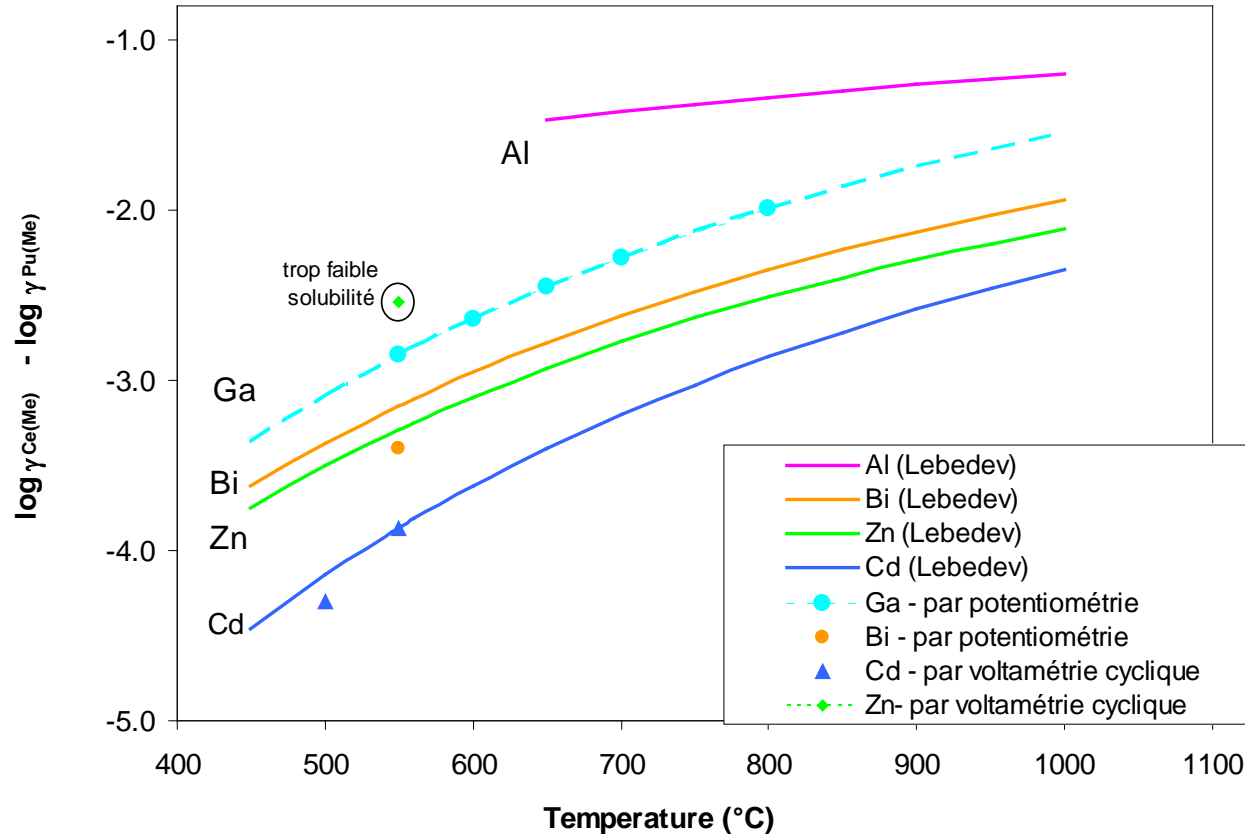

Comparison of activity coefficients in different metallic solvents

↪ Al best solvent

(A. Laplace et al., Proceeding 9th IEMPT, Nimes, September 2006)



Importance of activity coefficients!

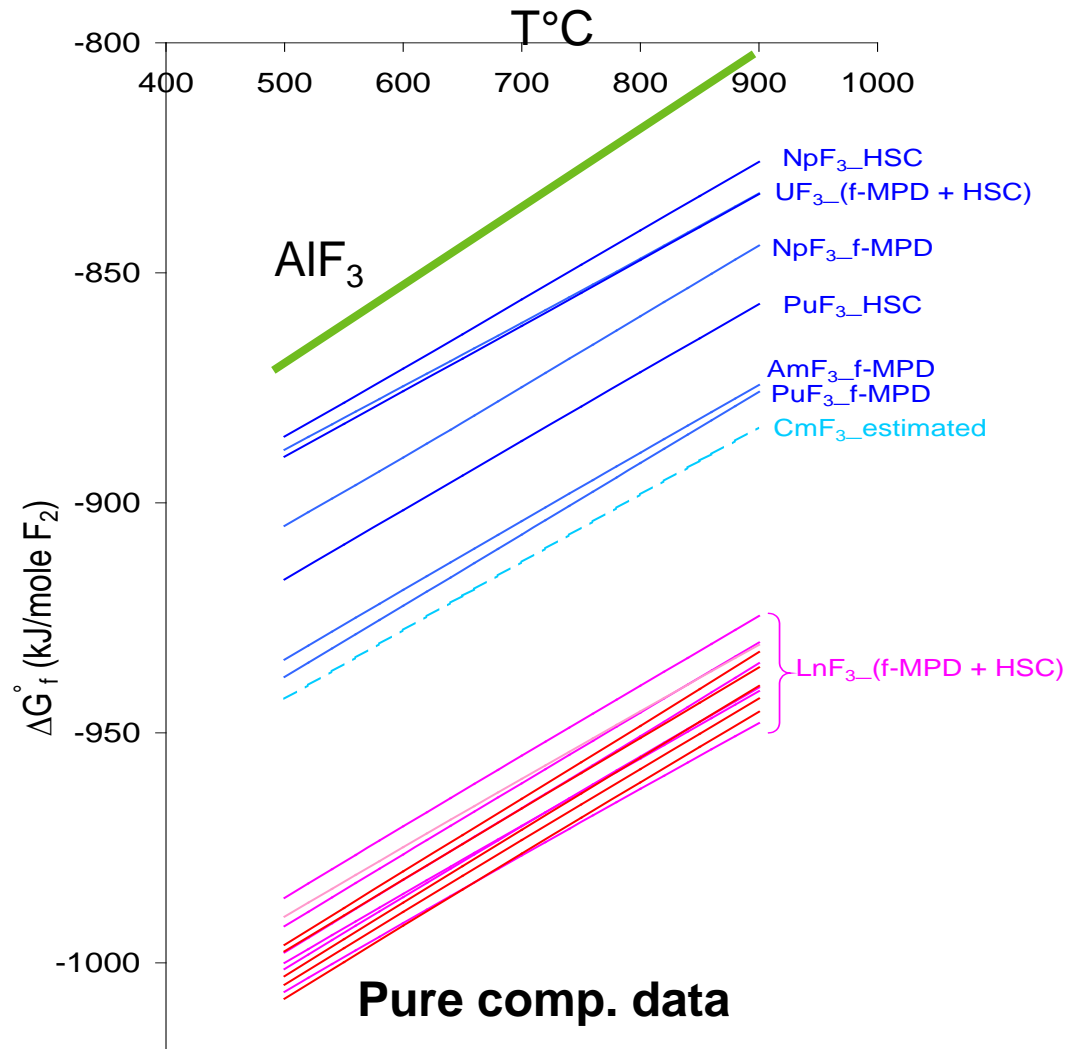

If we don't take into account activity coefficients, Al should not reduce An^{n+}



Reductive Extraction

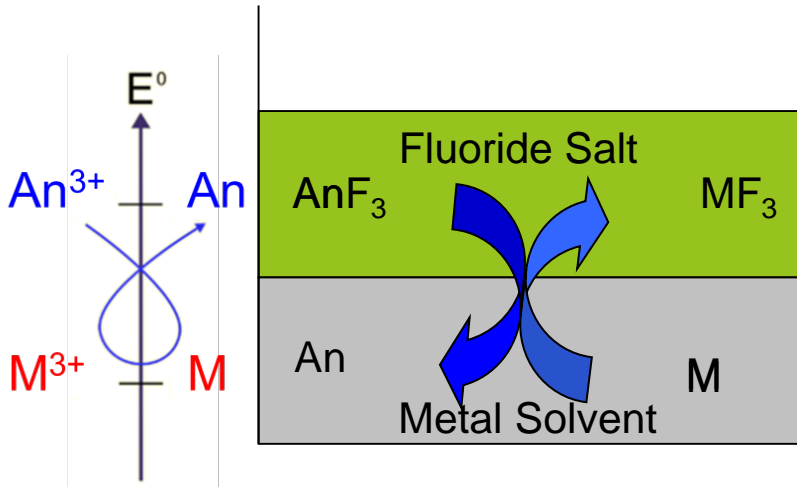
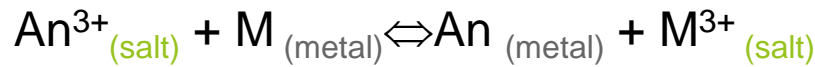

Oxidative Back-extraction

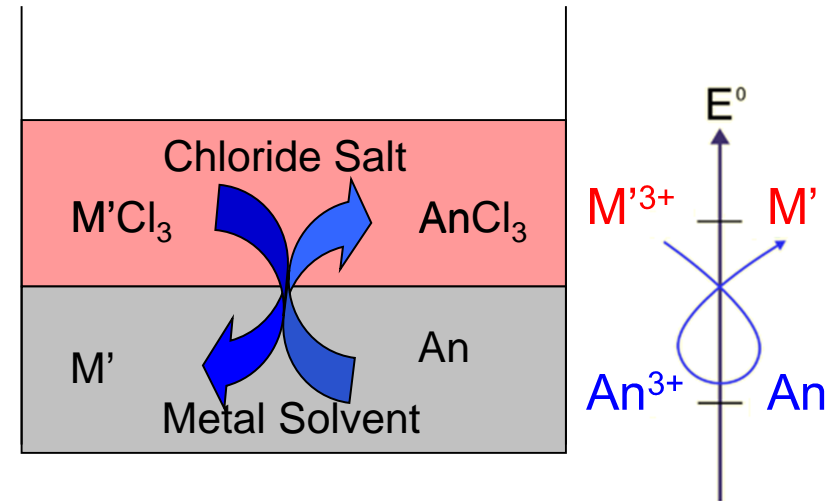
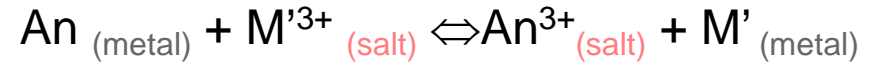

In fluorides

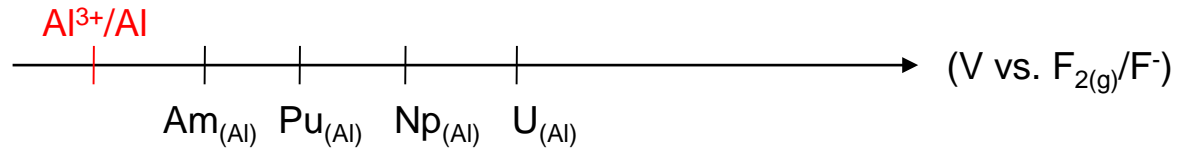

In chlorides



Experimental approach of the reductive extraction

Experimental procedure

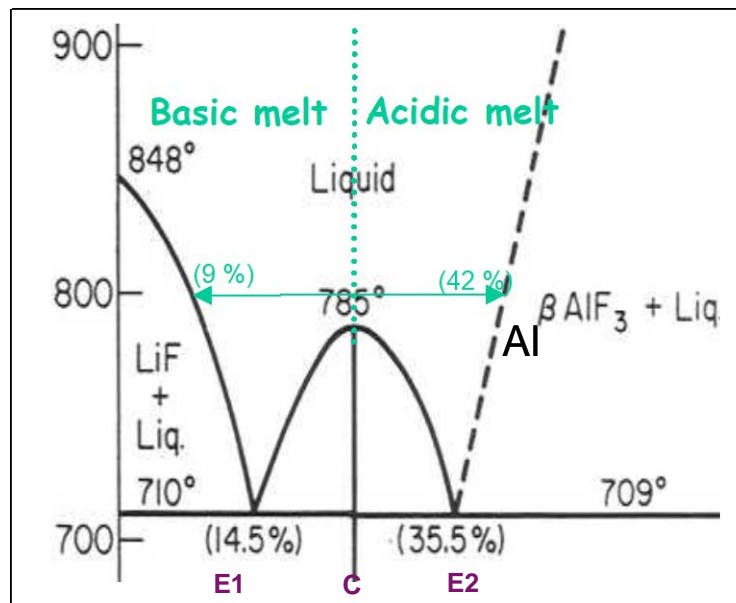
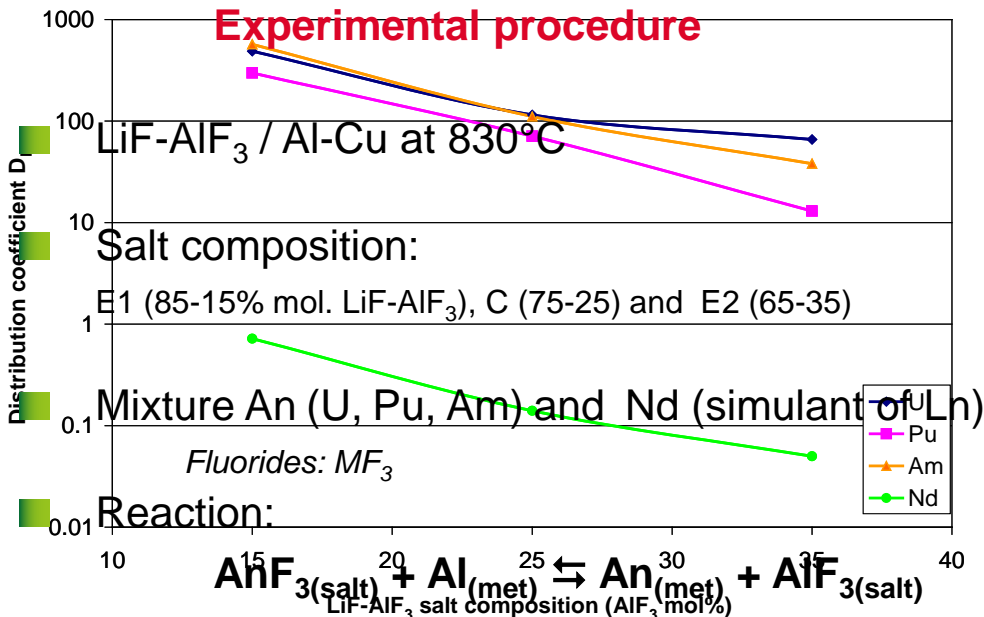

LiF-AIF₃ system, J.L Holm and B.J Holm, *Thermochim. Acta*, 6 [4] 375 (1973)

Distribution coefficient: $D = \frac{X_{An(Al)}}{X_{AnF_3(sel)}}$

D variation as function of salt composition

$$D_{An} = K \cdot \frac{\gamma_{AnF_3}}{\gamma_{An(Al)}} \cdot \frac{1}{a_{AIF_3}}$$

Excellents separation factors An/Ln >100

Core of process validation

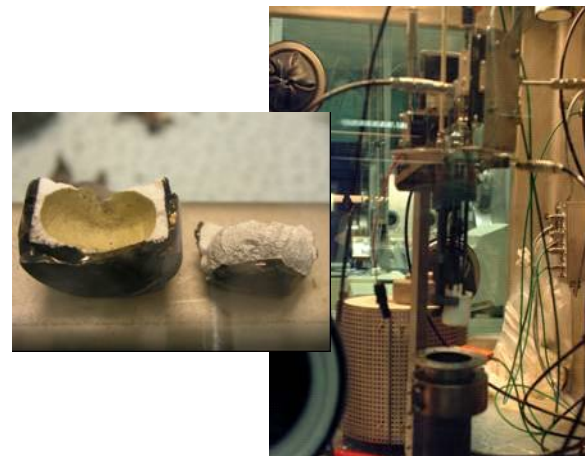

MSBR salt treatment process

Theoretical studies → online L/L extraction to reprocess part of the fuel

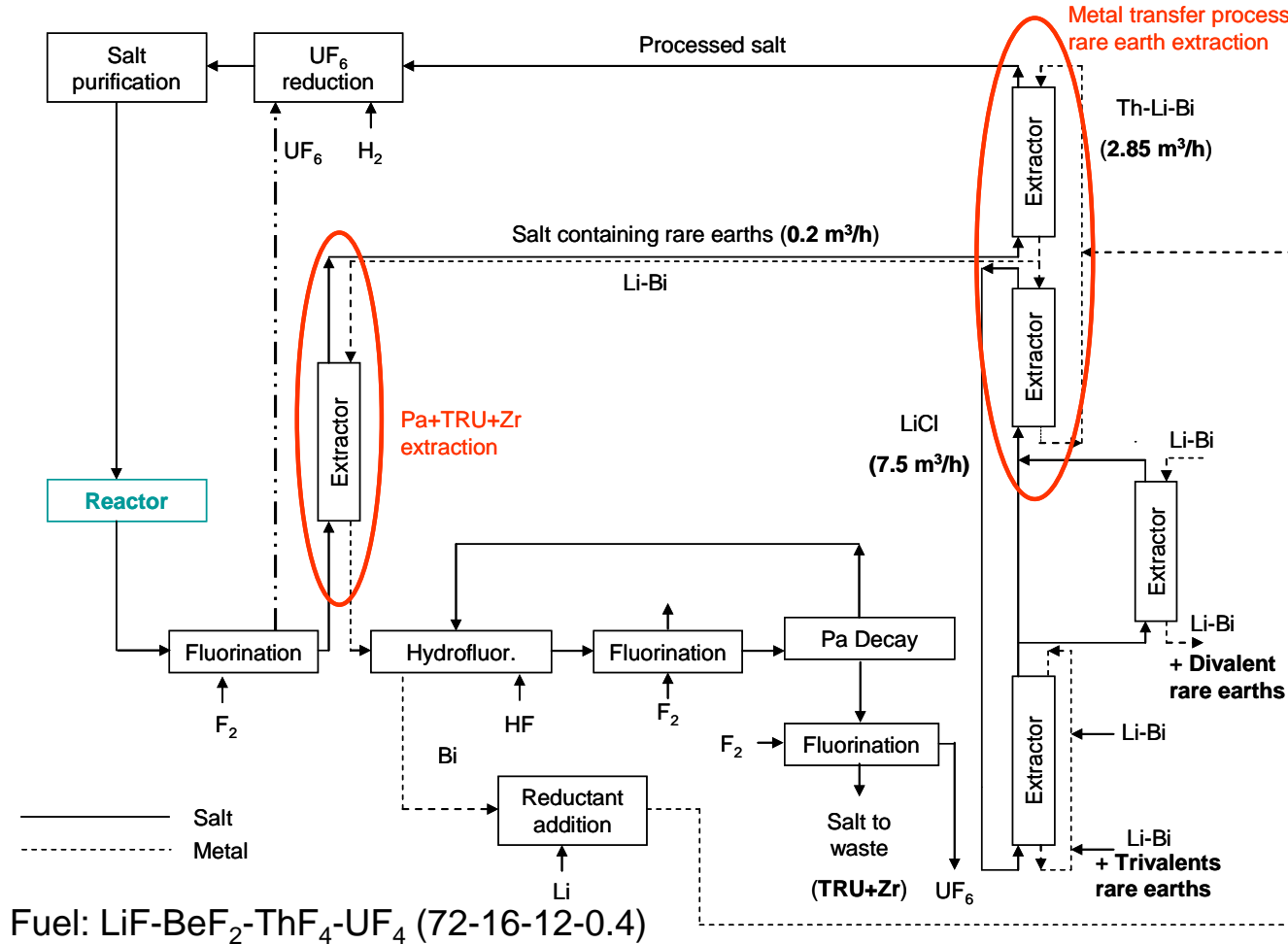

More complicated process:

needs first steps to remove An from salt + counter current L/L extraction to remove FP

Avoiding presence of Bi in the reactor

Reprocessing of 4m³/day

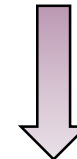

MSFR: fast reactor $\text{LiF}-\text{ThF}_4$ fuel

Reprocessing of 40L/day



Other option: TMSR salt treatment process

Chinese project: combination Pyro/Hydro processing

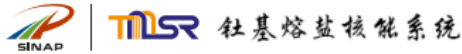

Flow sheet of TMSR Fuel Processing

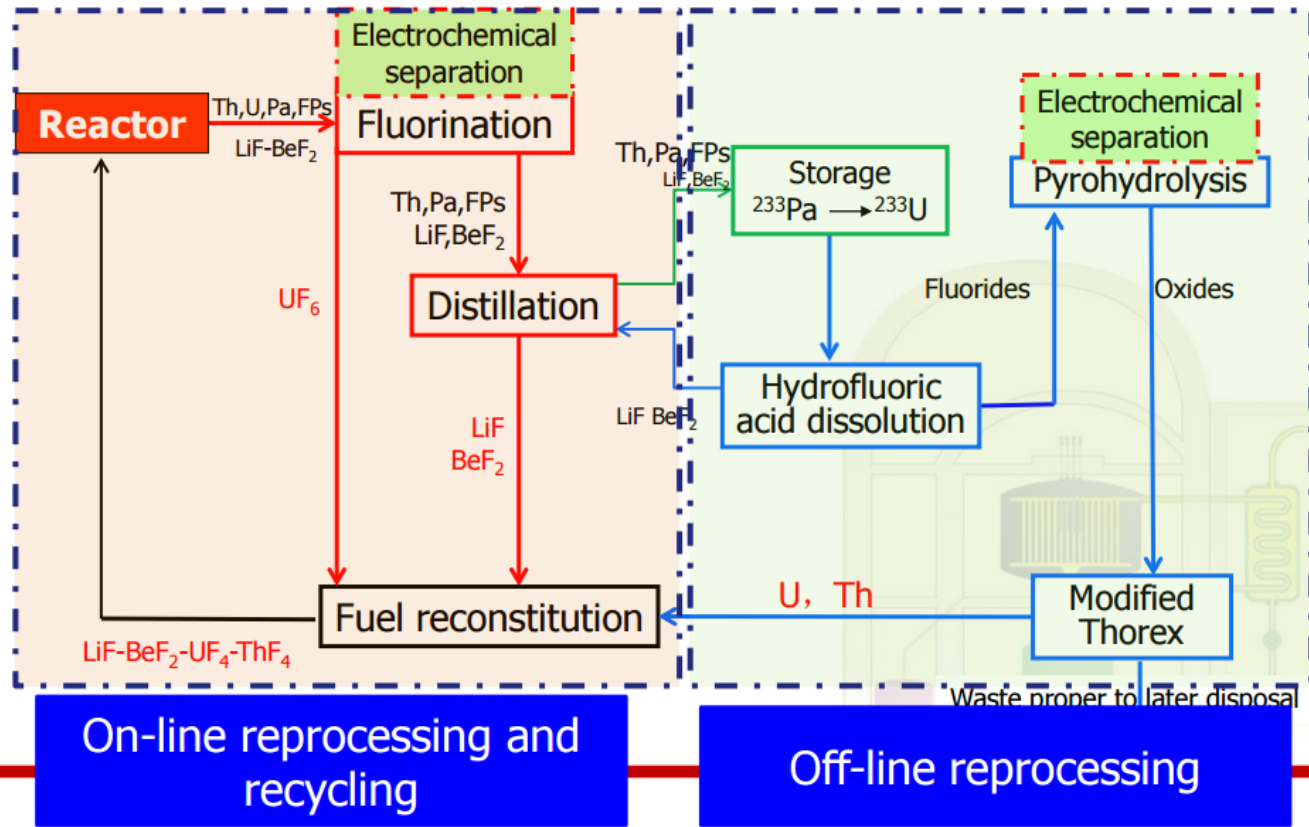

Source: Q. Li & al, IPRC 2014

Pyrometallurgic processes are complementary with hydrometallurgic processes regarding several aspects → *Treatment of particular fuels combustibles (metallic, MSR)*

→ *Possible developments of hybrids hydro/pyro processes (ex : Russia)*

At the CEA Marcoule: Two processes studied

Liquid/liquid reductive extraction process:

- Development of the core of process
- System studies
- Applications to treatment of inert matrices being investigated

Electrochemical separation process:

- Studies focussed on key steps of the electrorefining process
- Applications on recovery of strategic metals

Thank you for your attention

Commissariat à l'énergie atomique et aux énergies alternatives
Centre de Marcoule | BP17171 | 30207 Bagnols-sur-Cèze Cedex
France | T. +33 (0)4 66 79 62 75 | F. +33 (0)4 66 79 63 39

Direction de l'énergie nucléaire
Département de radiochimie des procédés
Service de modélisation et chimie des procédés de séparation

E^0 (V vs Cl_2/Cl^-) at 450°C

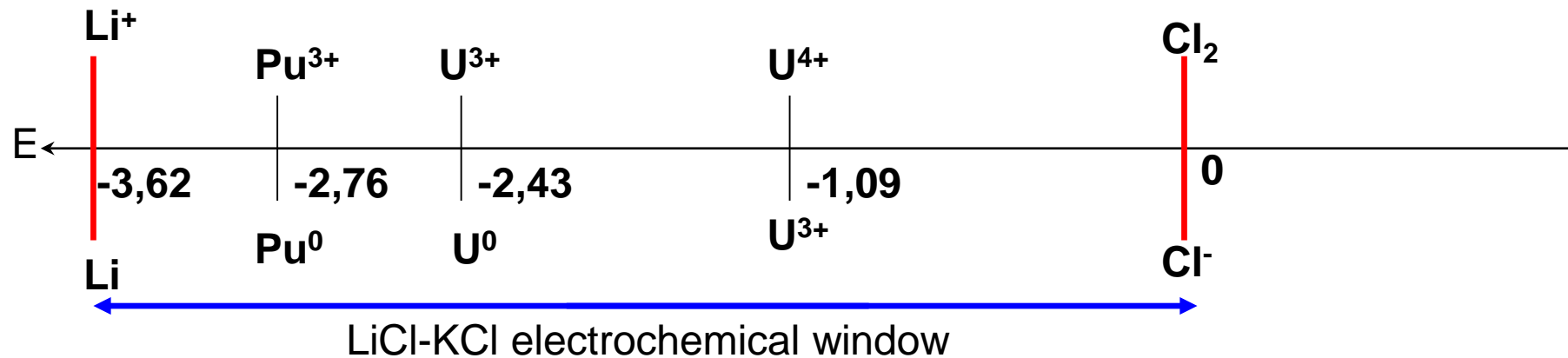

H_2O electrochemical window

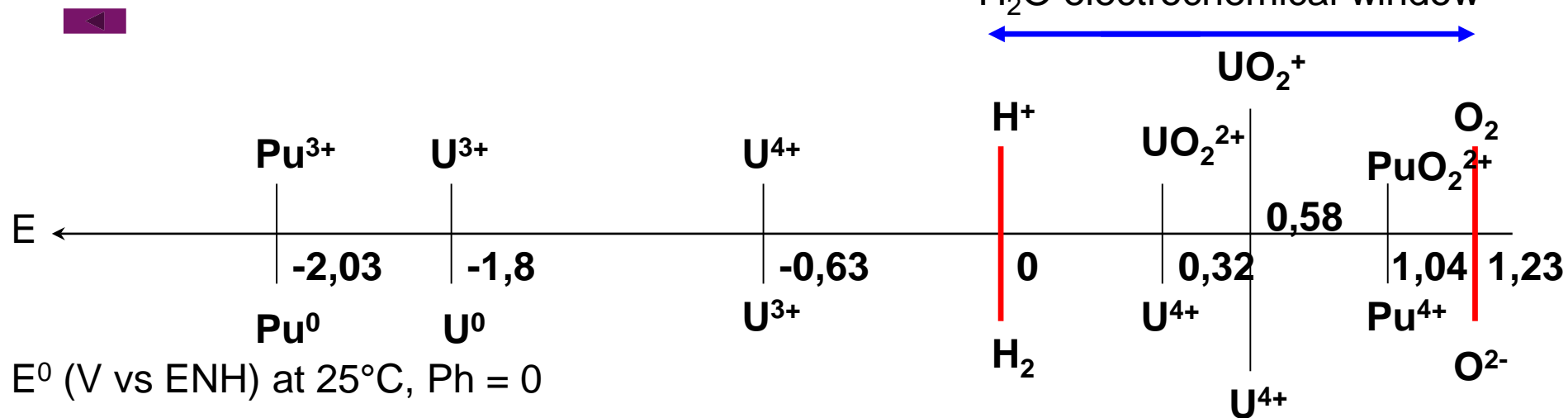

Thermodynamic properties of pure compounds

- Gibbs free Energy of formation of pure compounds
 - Separation

$$\Delta G = -n F \Delta E$$

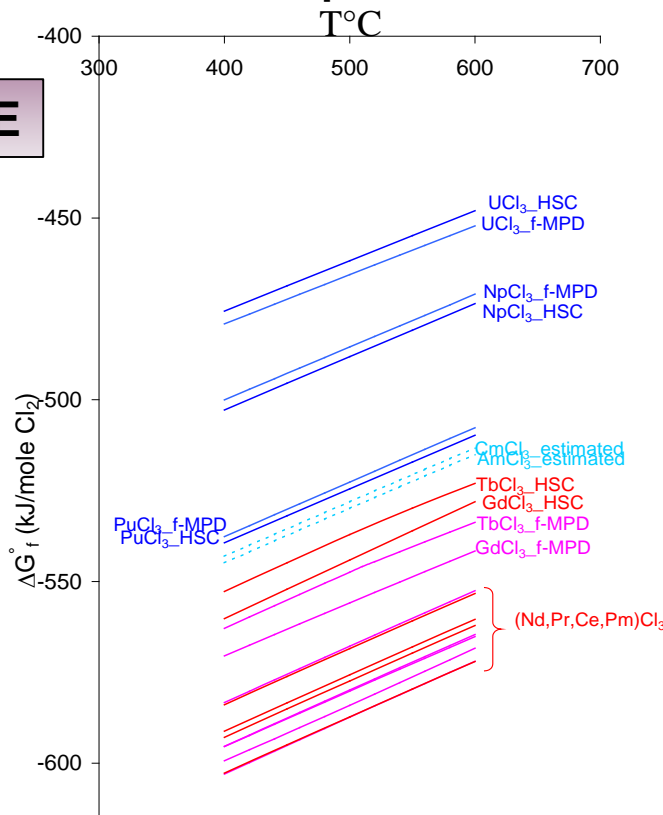

An and Ln chlorides

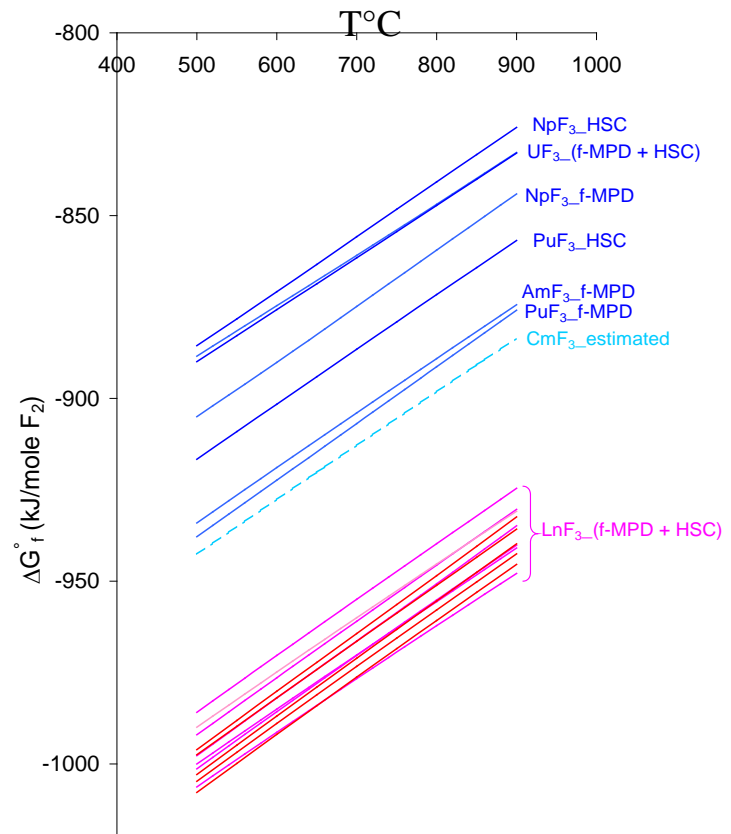

An and Ln fluorides

- "HSC chemistry for windows" (data mainly coming from Barin and Knacke tables)
 - f-MPD: Windows online database: f-elements.net



- Evolution of M^{n+}/M equilibrium potential (on solid inert electrode)

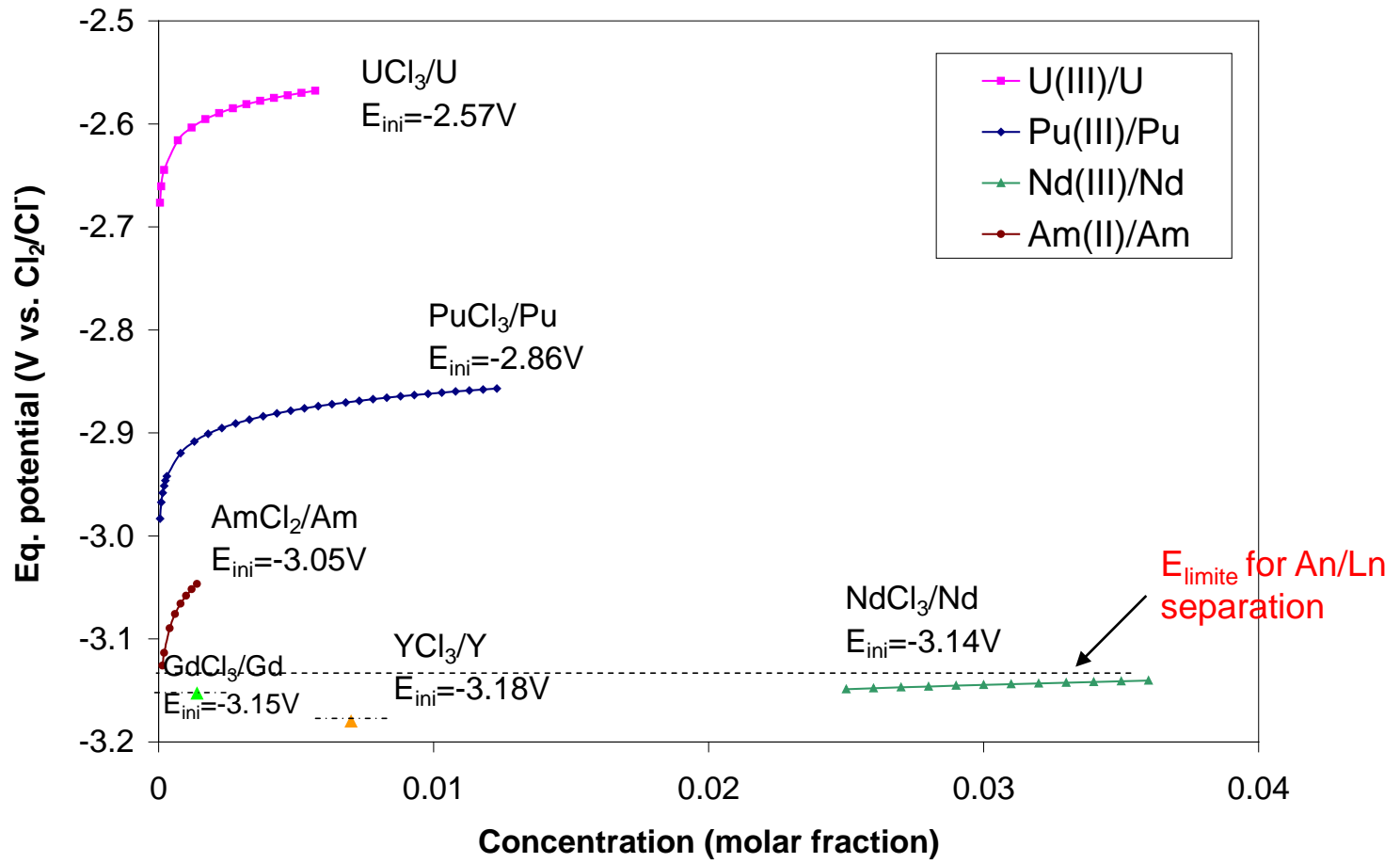

Activity coefficients in salt

LiCl-KCl, 773K

MX_n	$\text{Log}\gamma$	source
LaCl_3	-2,27	Castrillejo Y. (PYROREP)
CeCl_3	-2,30	Castrillejo Y. (PYROREP)
PrCl_3	-2,26	Castrillejo Y. (PYROREP)
GdCl_3	-2,34	Caravaca C (J. Nucl. Mater. 2007)
ThCl_4	-3.17	Cassayre L. (Electrochim. Acta)
UCl_3	-2,34	Caravaca C. (PYROREP)
NpCl_3	-2,30	De Cordoba (Note CEA)
PuCl_3	-2,39	Roy JJ (J. Electrochem. Soc. 1996)

- Activity coefficients of An and Ln chlorides are negative : High complexation with solvent

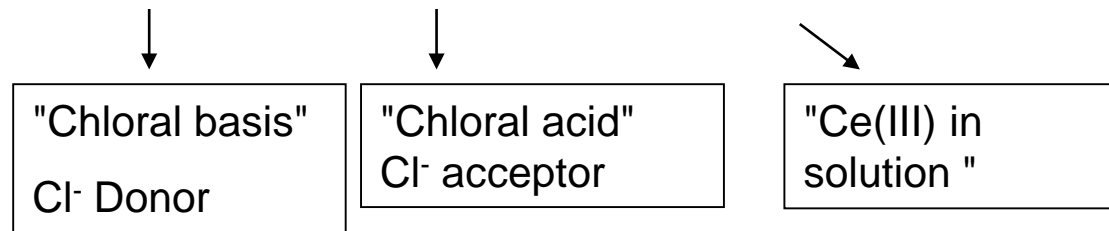

- $\text{Log}\gamma_{\text{MCl}_x}$ depend on :

- Oxidation state of M (IV<III<II<I)
- Ionic radius of M^{x+} (+small → +acid)



An^{3+} and Ln^{3+} : r^{3+} very close (~100pm) so γ values are also very close

Their interaction with salt can't contribute to An/Ln separation

