



HAL
open science

Numerical simulation of HELICOFLEX^R metallic gasket ageing mechanism for spent fuel cask

F. Ledrappier, A. Beziat, K. Vulliez, L. Mirabel, J. F. Juliaa, M. Wataru, K. Shirai, Hp. Winkler, R. Hueggenberg

► **To cite this version:**

F. Ledrappier, A. Beziat, K. Vulliez, L. Mirabel, J. F. Juliaa, et al.. Numerical simulation of HELICOFLEX^R metallic gasket ageing mechanism for spent fuel cask. Workshop on sealing 2016, Oct 2016, Paris, France. cea-02438339

HAL Id: cea-02438339

<https://cea.hal.science/cea-02438339v1>

Submitted on 14 Jan 2020

HAL is a multi-disciplinary open access archive for the deposit and dissemination of scientific research documents, whether they are published or not. The documents may come from teaching and research institutions in France or abroad, or from public or private research centers.

L'archive ouverte pluridisciplinaire **HAL**, est destinée au dépôt et à la diffusion de documents scientifiques de niveau recherche, publiés ou non, émanant des établissements d'enseignement et de recherche français ou étrangers, des laboratoires publics ou privés.

DE LA RECHERCHE À L'INDUSTRIE



www.cea.fr



Numerical simulation of HELICOFLEX® metallic gasket ageing mechanism for spent fuel cask

Workshop sealing 2016
October 14th, 2016 - Paris

F.LEDRAPPIER^a, A.BÉZIAT^b, K.VULLIEZ^b, L.MIRABEL^b, J.F.JULIAA^a,
M.WATARU^c, K.SHIRAI^c, H-P.WINKLER^d, R. HUEGGENBERG^d

^a TECHNICS Group France, Laboratoire d'Étanchéité, 2 rue James Watt 26700 Pierrelatte, France.

^b CEA, DEN, SDTC, Laboratoire d'Étanchéité, 30207, Bagnols Sur Cèze France.

^c Central Research Institute of Electrical Power Industry, 1646 Abiko, Abiko-shi, Chiba-ken 270-1194, Japan

^d Gesellschaft für Nuclear-Service GmbH, Hollestrasse 7A, 45127 Essen, Germany.



Introduction

- Context & Objectives
- Ageing tests methodology



Experimental database

- 100,000 hours ageing tests results
- Analytical processing

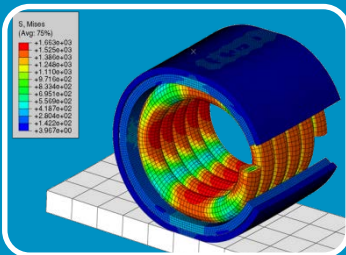

Numerical simulation

- Numerical model presentation
- Results & Discussion



Cooperation Agreement Relating to Ageing of sealing performances



Objectives:

Metallic seals ageing tests are carried out since 1999 to assess their behavior for long periods for spent fuel storage casks.

Method:

Accelerated ageing tests of seals at higher temperature.

- More than **100,000 h** ageing tests at 20, 100 and 200°C
- Residual linear load measurement (Y2R).
- Statistical analysis : 120 mockups used, 444 points.

Metallic seals ageing mechanisms:

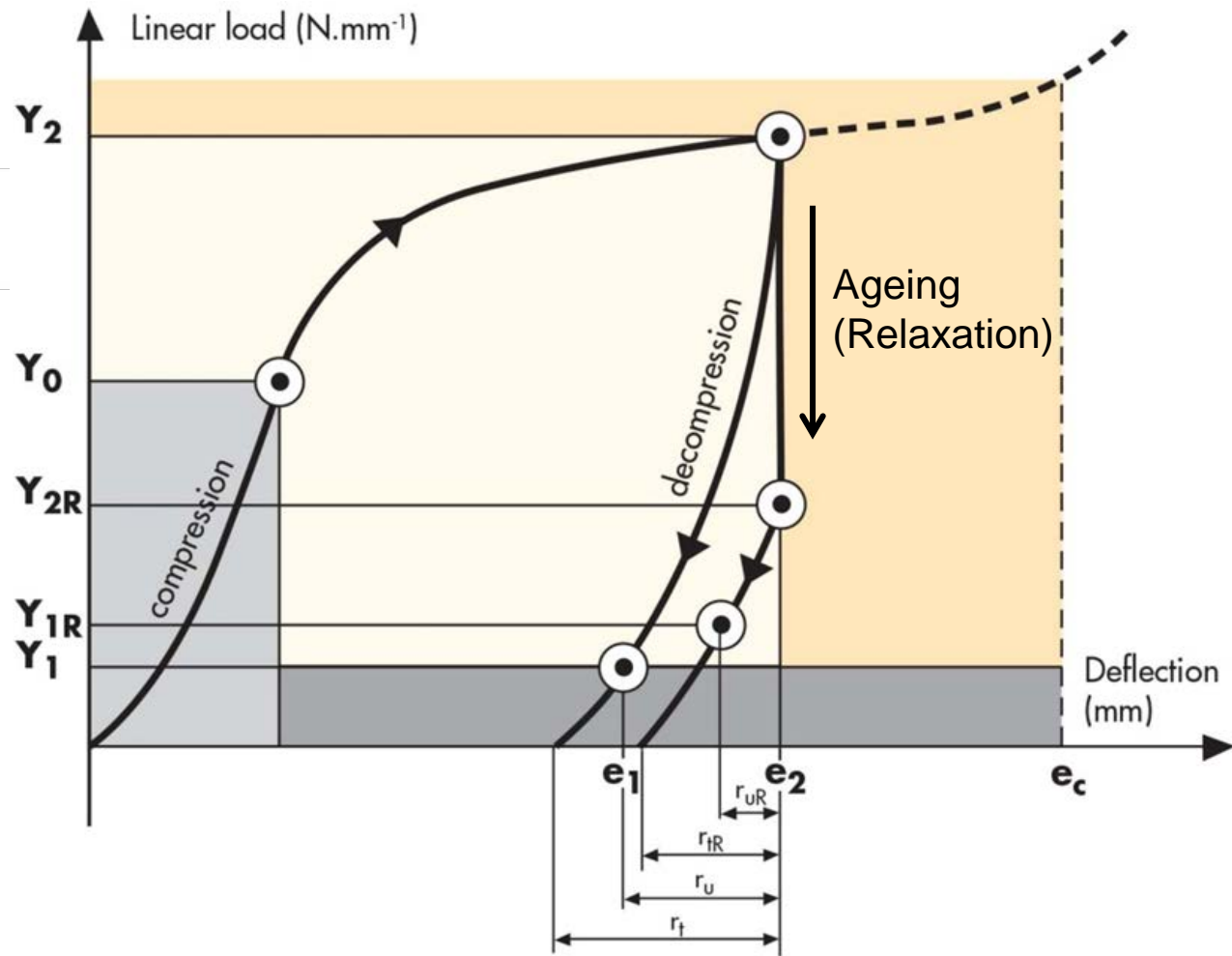
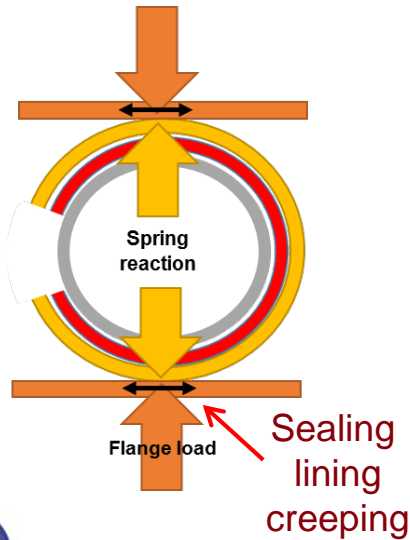



Measurement of the compression curve before ageing.

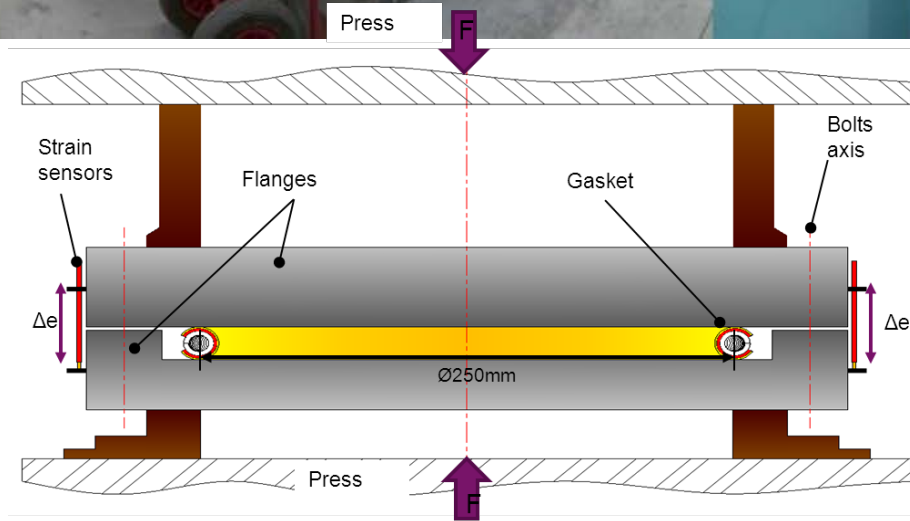
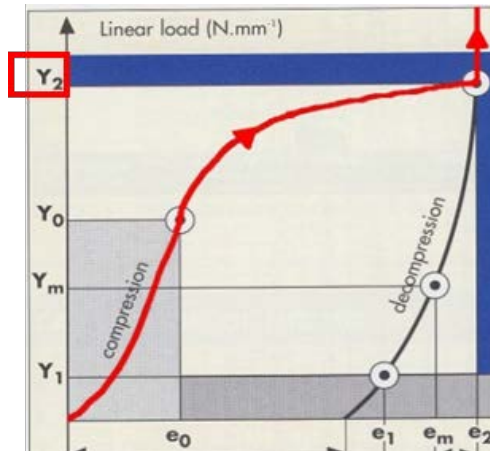



Ageing in ovens at RT, 100 and 200°C
up to 100,000h.

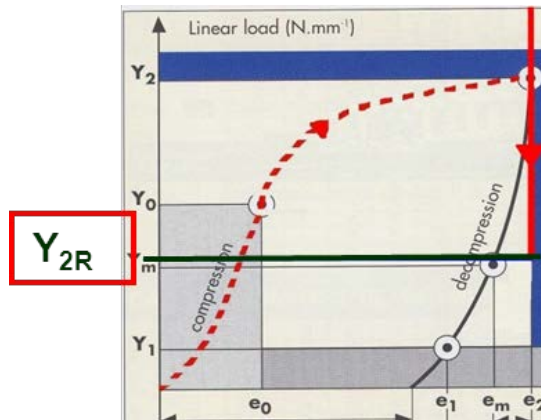



Measurement of the decompression curve after thermal ageing.

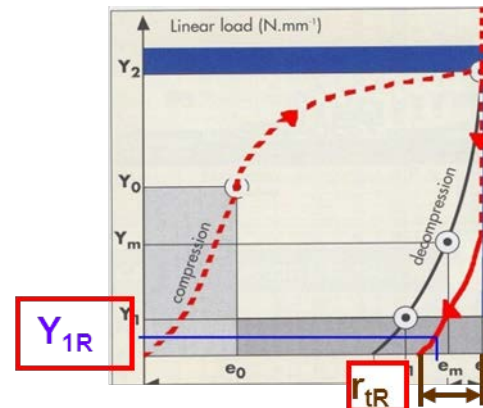

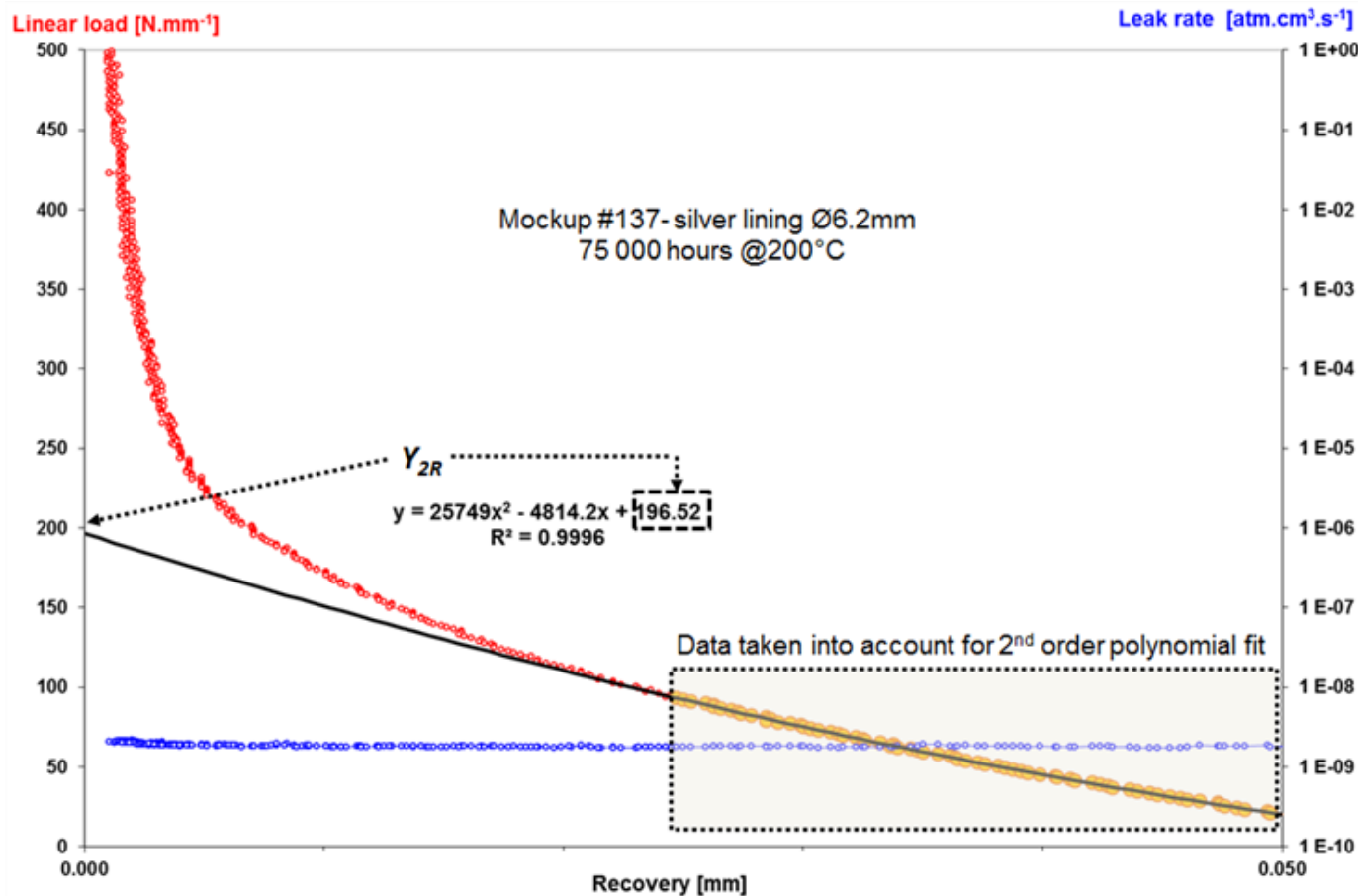

Example of Y_{2R} determination: mockup#137, Ø6.2 mm section silver lining seal held at 200°C for 75,000 h. Blue curve: leak rate measurement. Red curve: residual seal loading.

Available database related to 100,000 hours ageing tests

- Mock-up tightening on instrumented press device
- Accelerated ageing in ovens
- Unloading with instrumented press (@ RT, partial opening on regular time base)
- Tightening and further ageing...
- Time & Temperature equivalence suggested using Larson Miler Parameter :

$$LMP = T \times [C + \log(t)]$$

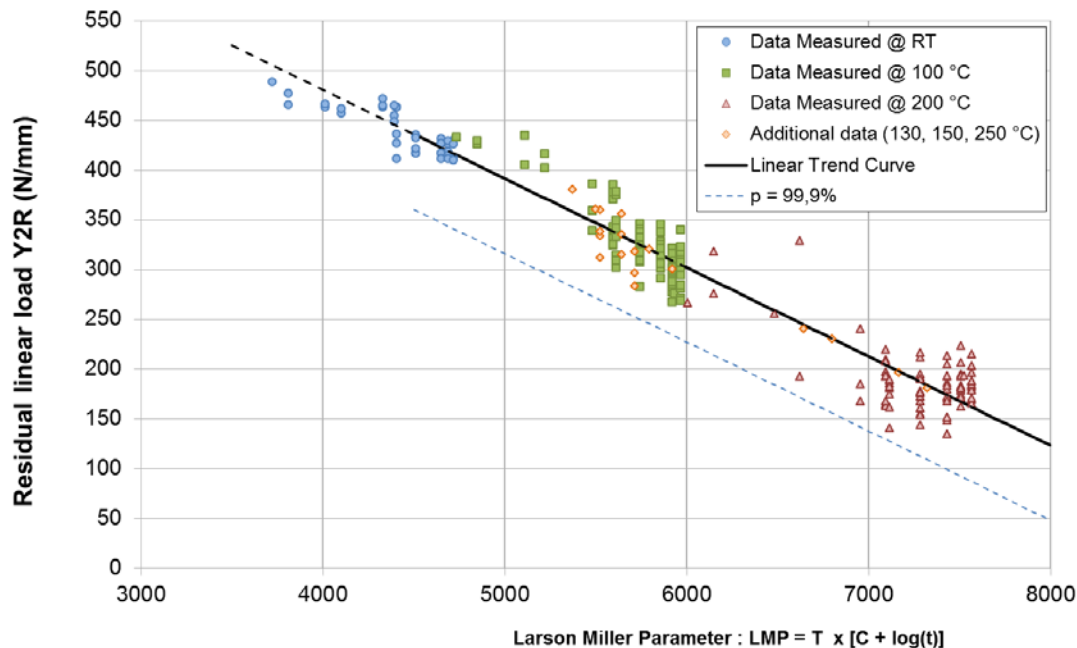

Ø8.4 mm silver seals tests results

Ageing Temperatures :

- RT
- 100 °C
- 200 °C

Ageing durations :

- 10,000 hours
- 25,000 hours
- 50,000 hours
- 75,000 hours
- 100,000 hours

Facts :

- Metallic seals have a complex behavior during ageing :
- Seal compression is constant → Seals relaxation
- Creep of the silver jacket
- Non-linear spring-back reaction

Idea : Consider a polynomial spring back

Initial compression/unloading test :

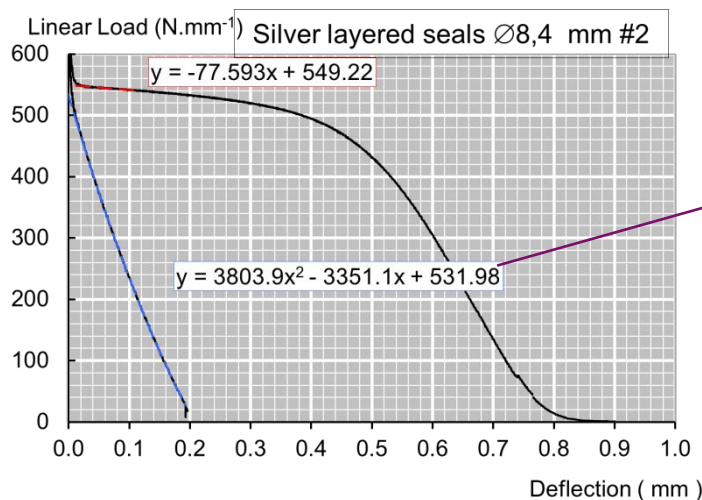

$$F = K_1x^2 + K_2x + K_3$$

$$F = \zeta \cdot \dot{x}$$

F : Linear load
 x : Displacement
 K_1, K_2, K_3 : Non linear stiffness factors
 ζ : Damping coefficient

Idea : Consider a polynomial spring back

Model presentation :

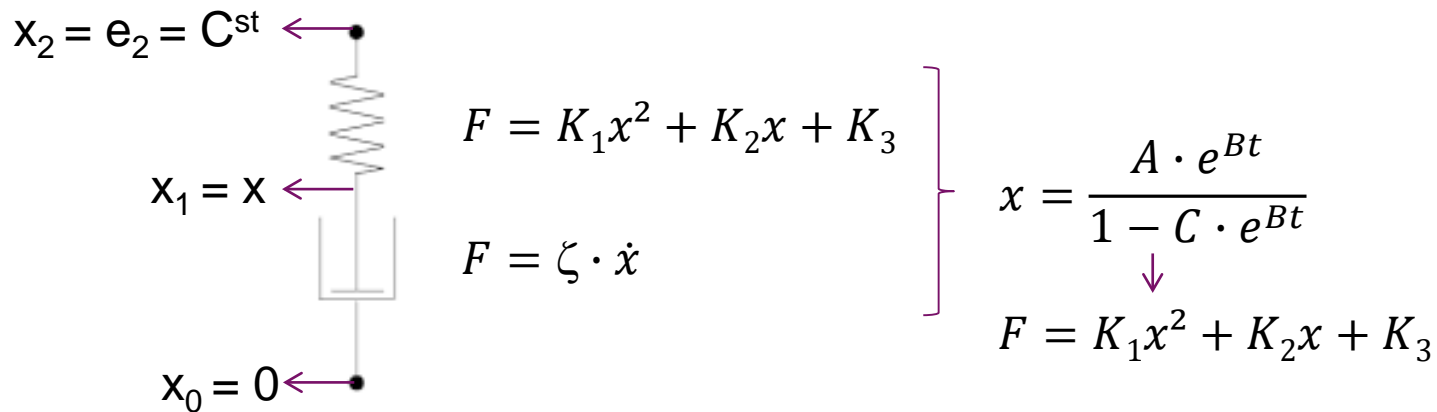

Coefficients optimization : A, B, C, K_1 & K_2 ($K_3 = 185$ N/mm)

Use a gradient algorithm (Python)

Result depends on guess parameters

→ Need to apply a genetic algorithm (ongoing)

LMP-Generalized Maxwell relaxation model

Relevant with RT data : increase the database

Standard deviation = 30 N/mm

→ Need to increase data @ intermediate steps

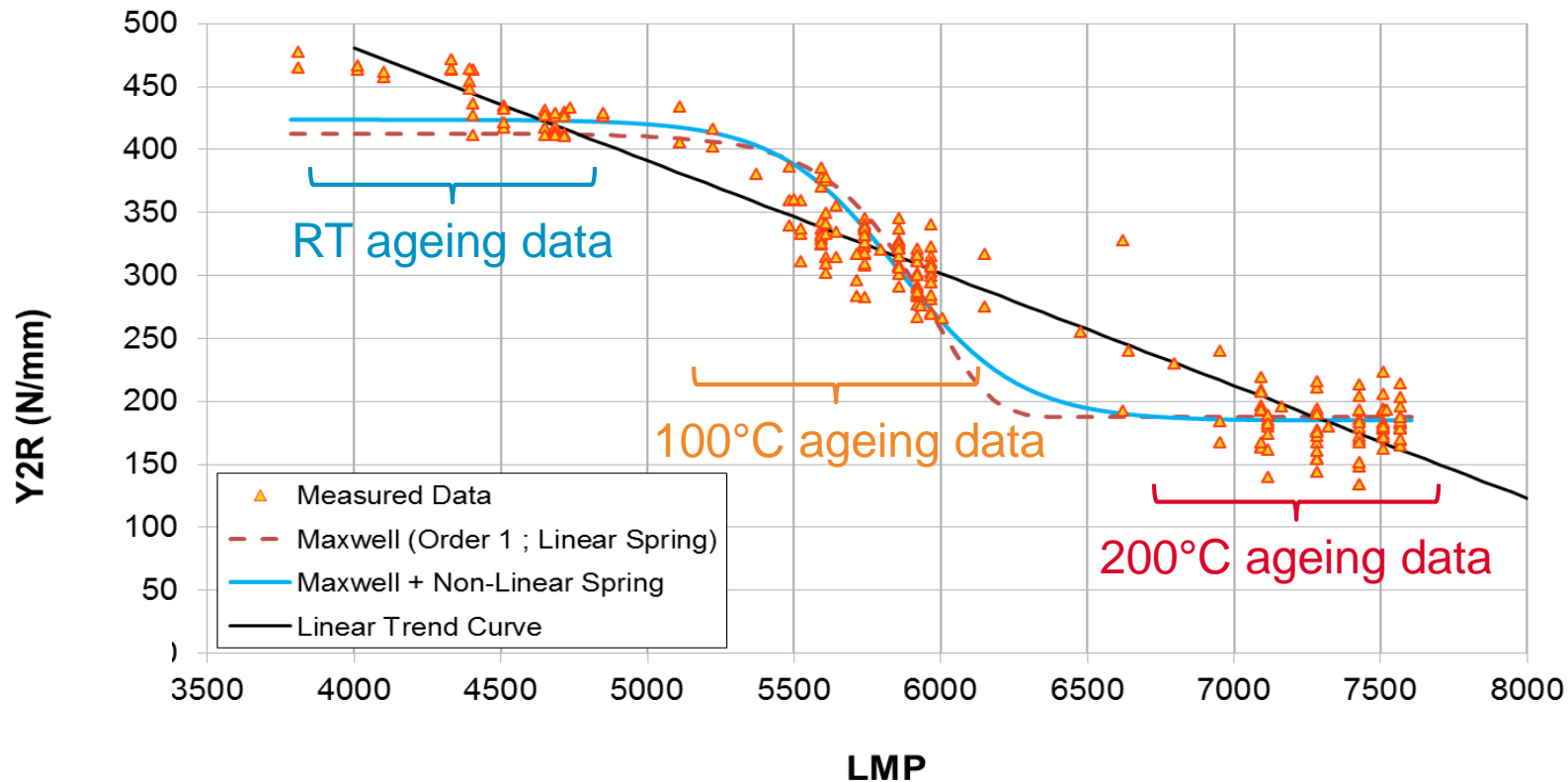

Discussion on tests results :

- Changes in seals designs and materials affect:
 - “C” constant of LMP
 - Linear trend curve of ageing
 - In some cases, linear trend curve does not describe properly behavior at shorter times (data at RT)
- Seal simulations using FEA approaches would be required to assess :
- Behavior in various ageing scenarios
 - Behavior of different seals designs

Seals Tightening simulation

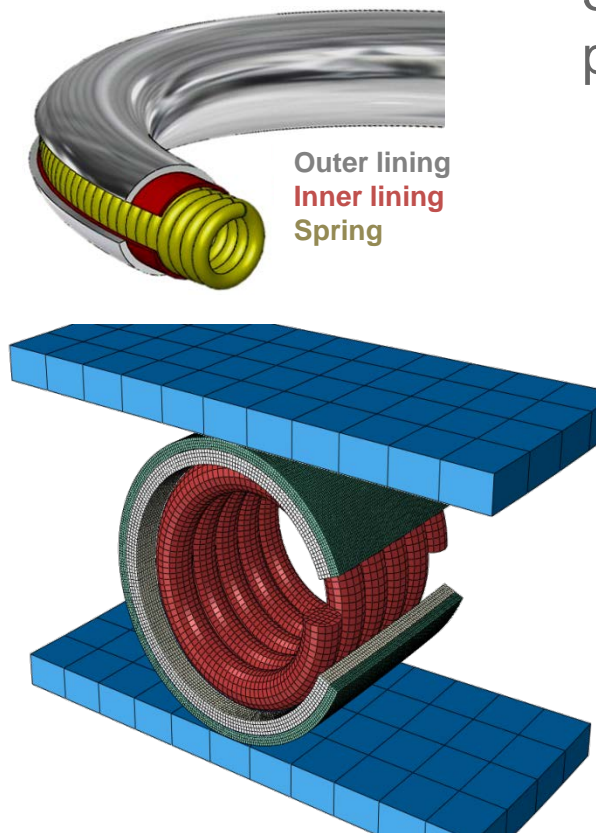

3D Model of HELICOFLEX® is used for a better precision

- Elastic-Plastic behavior for each component
- Perfectly rigid flanges
- Spring made of 5 Coils considered
- Faces of spring coupled
(reproduce cyclic symmetry)
- Symmetry along r-z plane of jackets
- Contacts between each bodies with Friction
- Explicit simulation help to solve convergence issues related to contacts management

Seals Tightening simulation

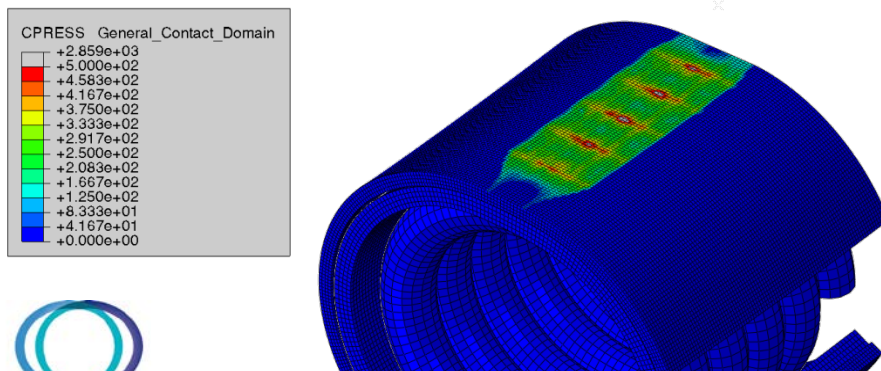
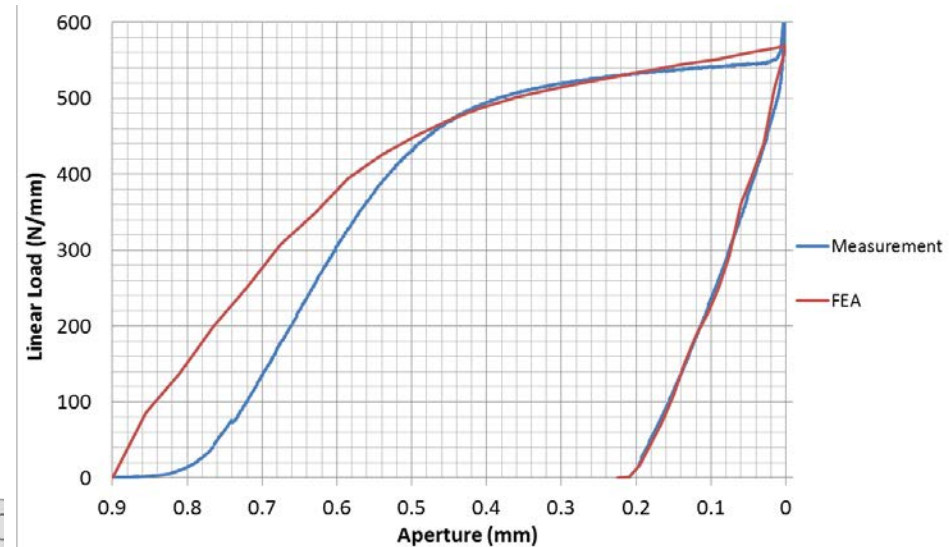
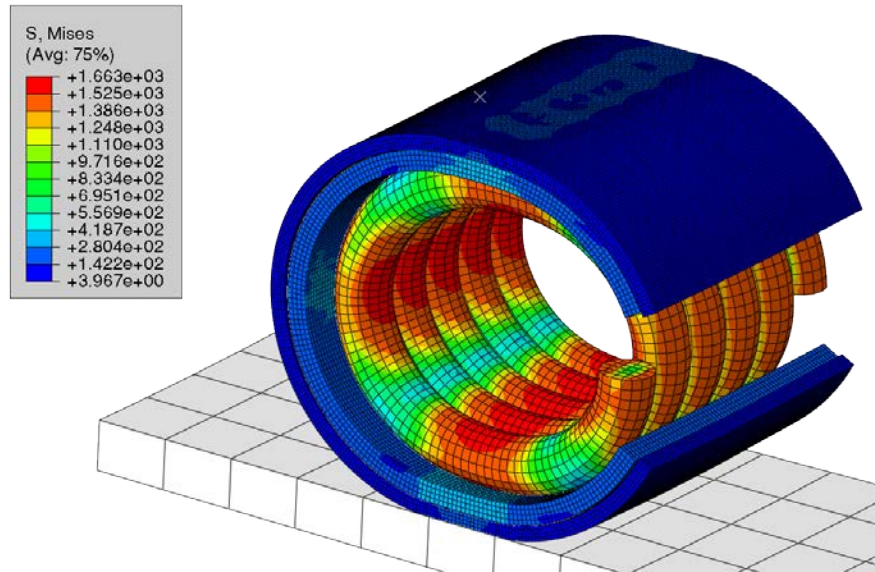

- Good correlation of simulations / tests
- Influence of geometric tolerances & material behavior

Creep tests :

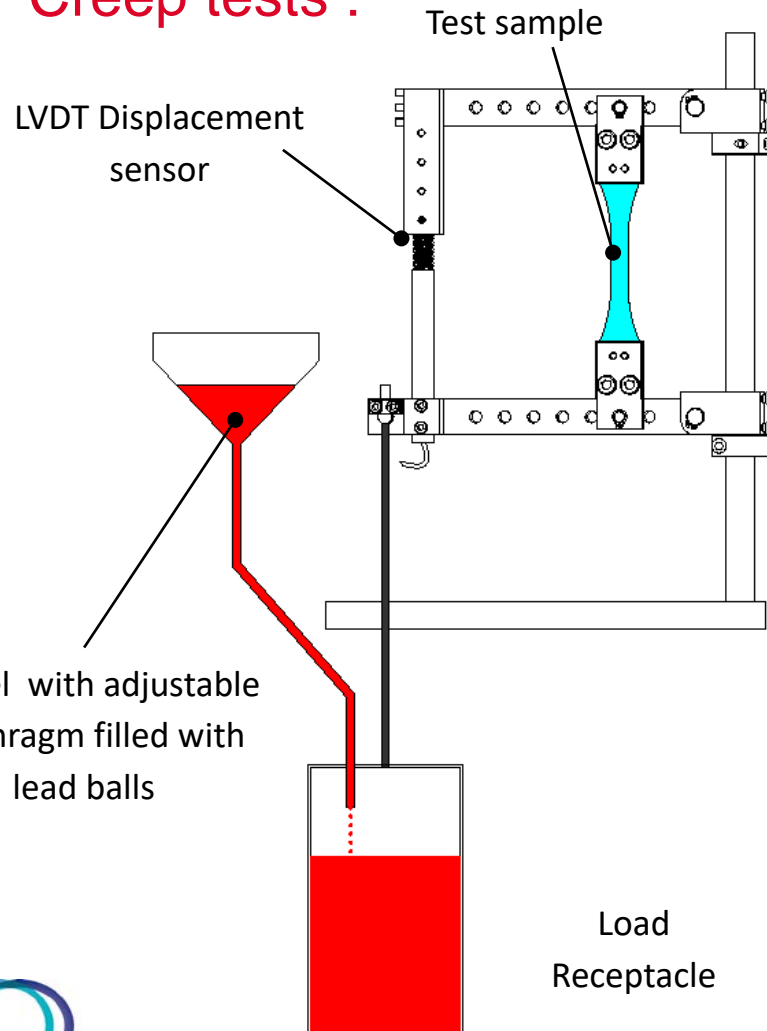

- Samples loaded progressively by gravity with $\varnothing 2\text{mm}$ lead balls
- Sample installation (check LVDT sensor measurement range regarding expected elongation)
- 3 samples are tested simultaneously
- Heating in oven
- Small pre-Loading applied (to suppress initial gaps)
- Loading



Creep tests :

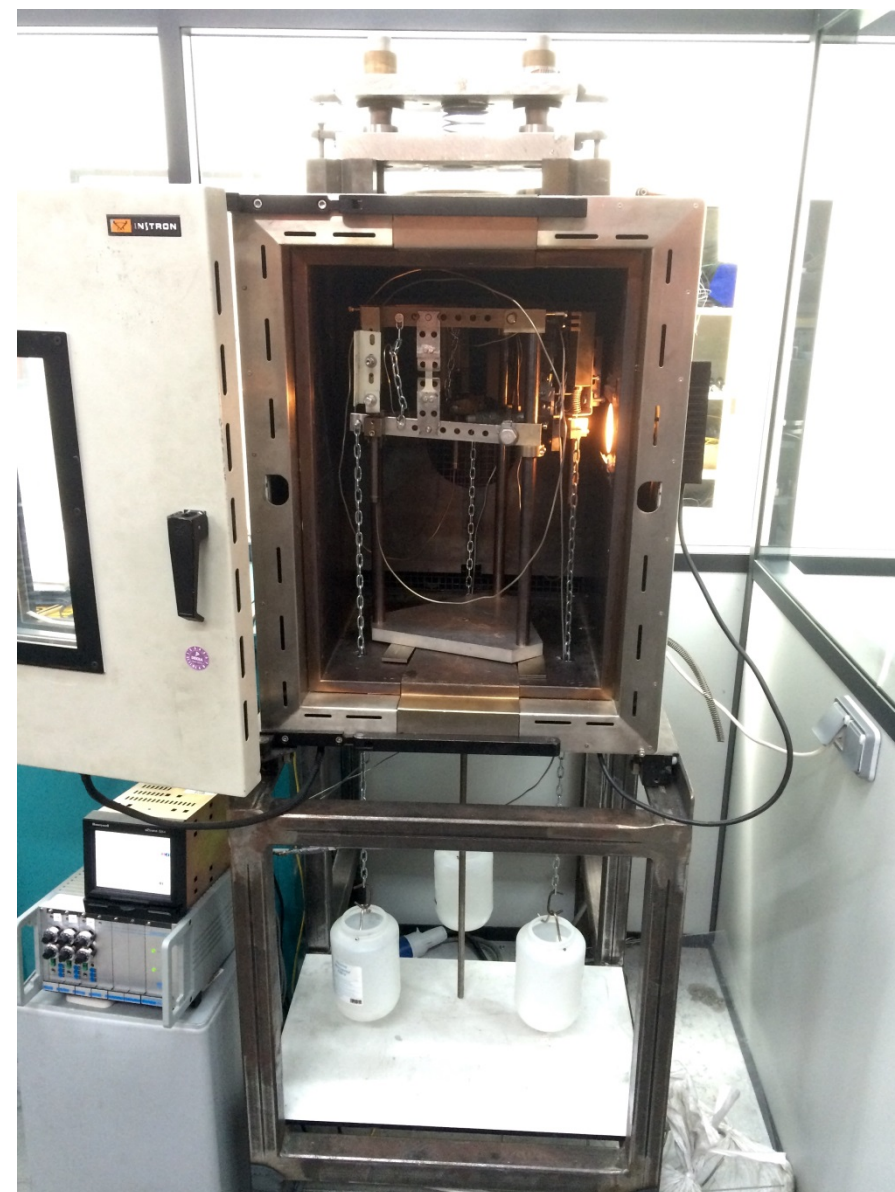
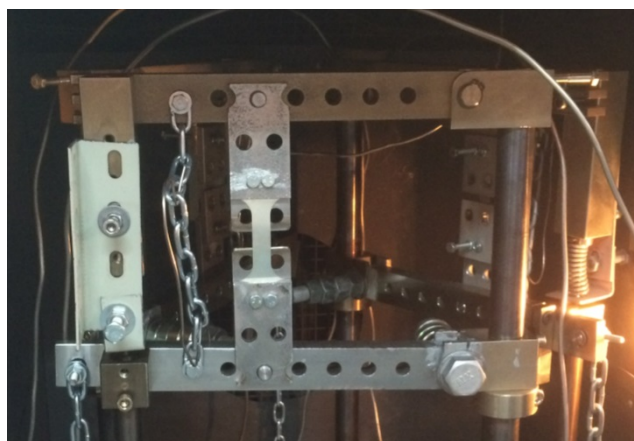
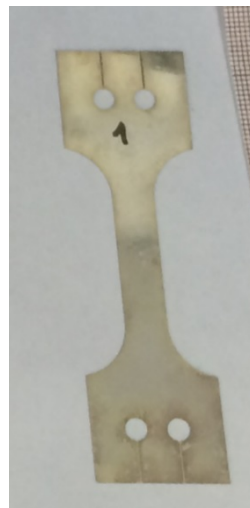

Tests analysis

Creep law coefficients (C_1 , C_2 , C_3) are fitted according to tests data

$$\dot{\varepsilon} = C_1 \cdot \sigma^{C_2} \cdot \varepsilon^{C_3}$$

- 3 Samples / Tests conditions
- 3 Stresses
- 4 Temperatures : 50 °C ; 100 °C ; 150 °C ; 200 °C

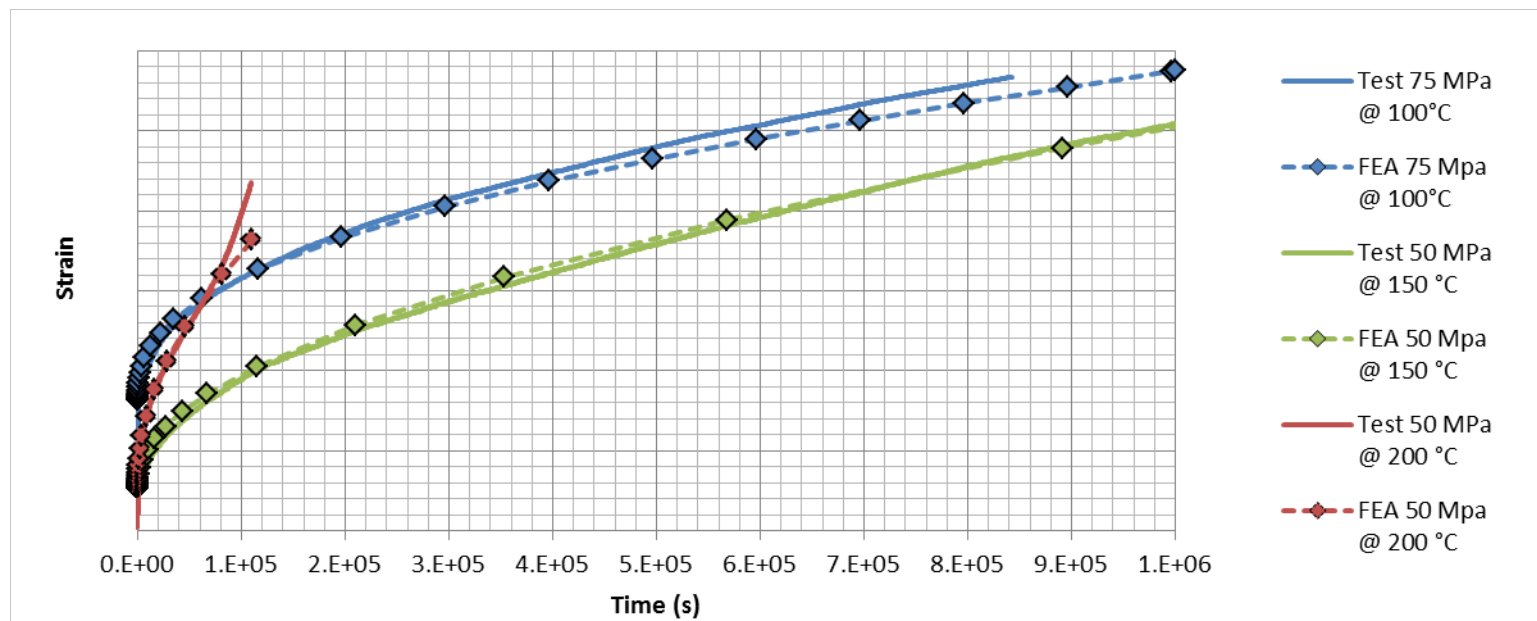

Methodology for Finite Elements Analysis

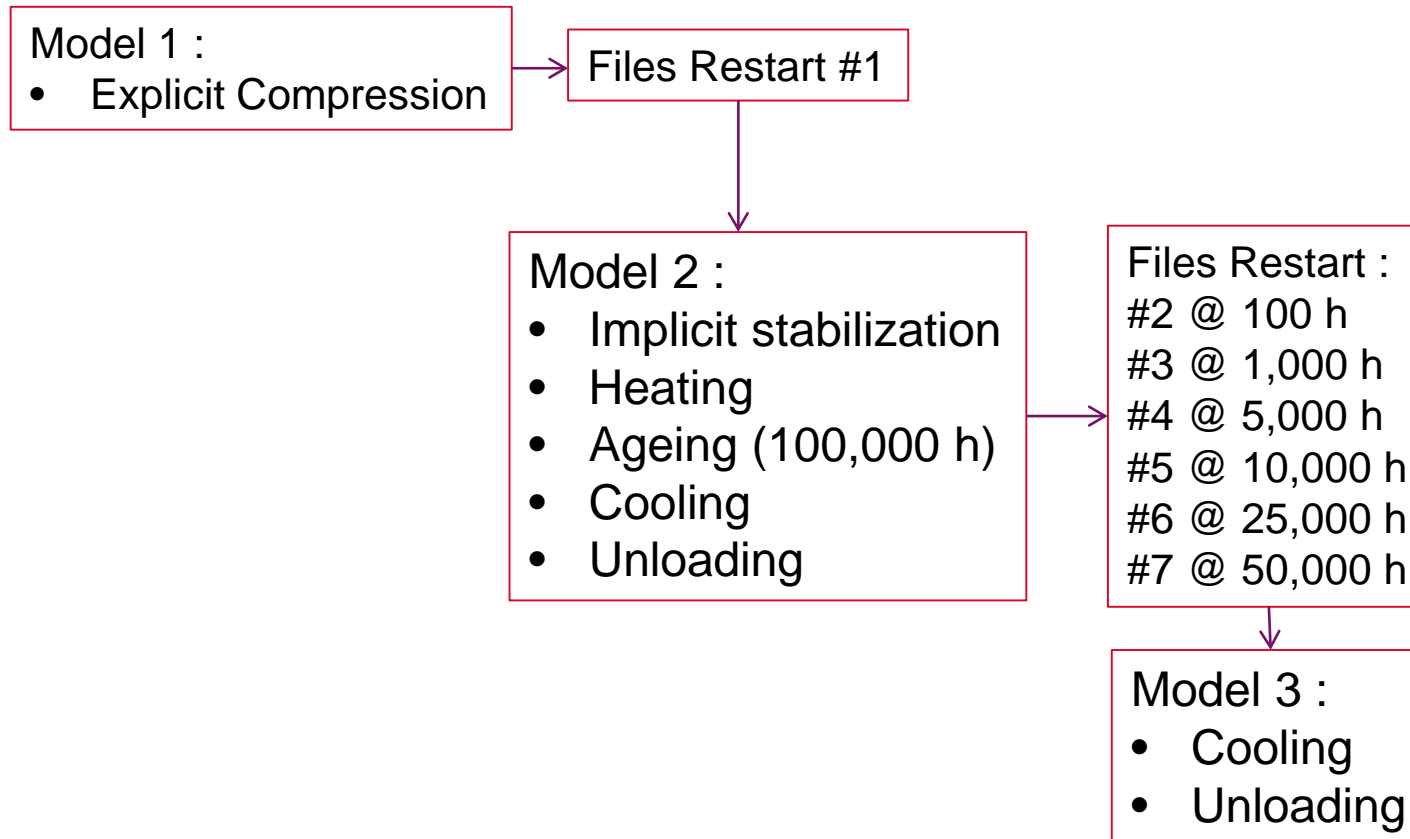

Results

- Y2R drop as a function of LMP remains convenient

$$LMP = T \times [11 + \log(t)]$$
- Comparison with experimental data is consistent

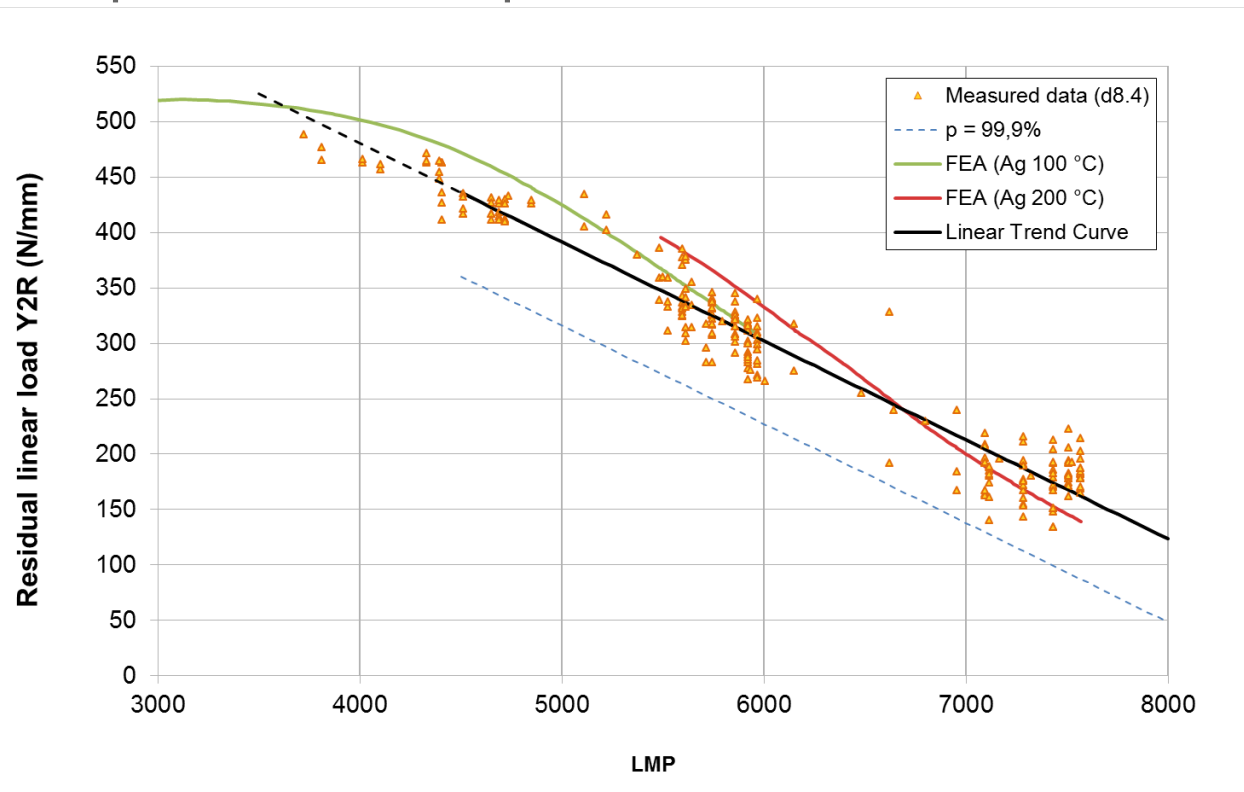

Results

- Adjustment on “C” constant improve calculated curve continuity using LMP Time-Temperature equivalence

$$LMP = T \times [9 + \log(t)]$$
- This adjustment increases maximum ageing temperature

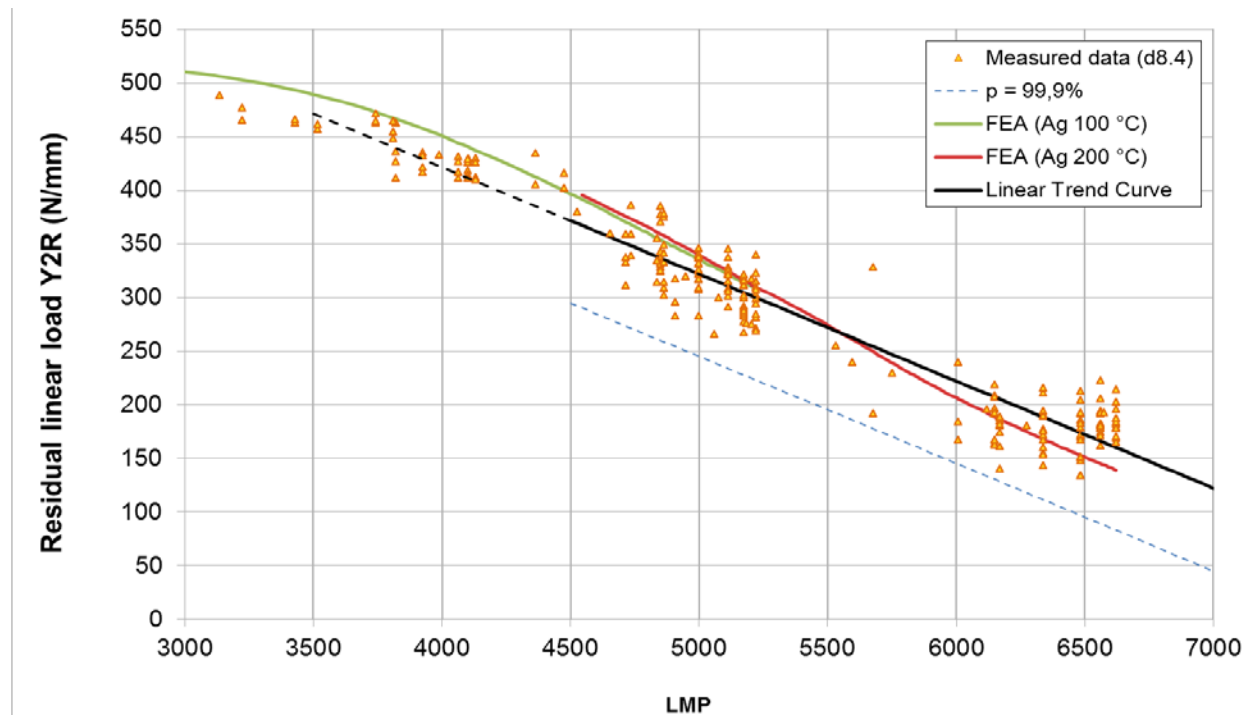

Results

Maximum ageing temperature to keep Y2R above threshold in 99.9 % cases after **60 years**

Y2R (N/mm)	C = 9	C = 11
0	233 °C	168 °C
20	219 °C	155 °C
50	199 °C	135 °C

Maximum ageing temperature to keep Y2R above threshold in 99.9 % cases after **100 years**

Y2R (N/mm)	C = 9	C = 11
0	225 °C	162 °C
20	212 °C	149 °C
50	192 °C	130 °C

Results :

- Calculated spring back curve after 100,000 hours ageing is consistent regarding experimental curves
- Mock-up stiffness is not included yet in this model :
a 15 μm deflection is expected

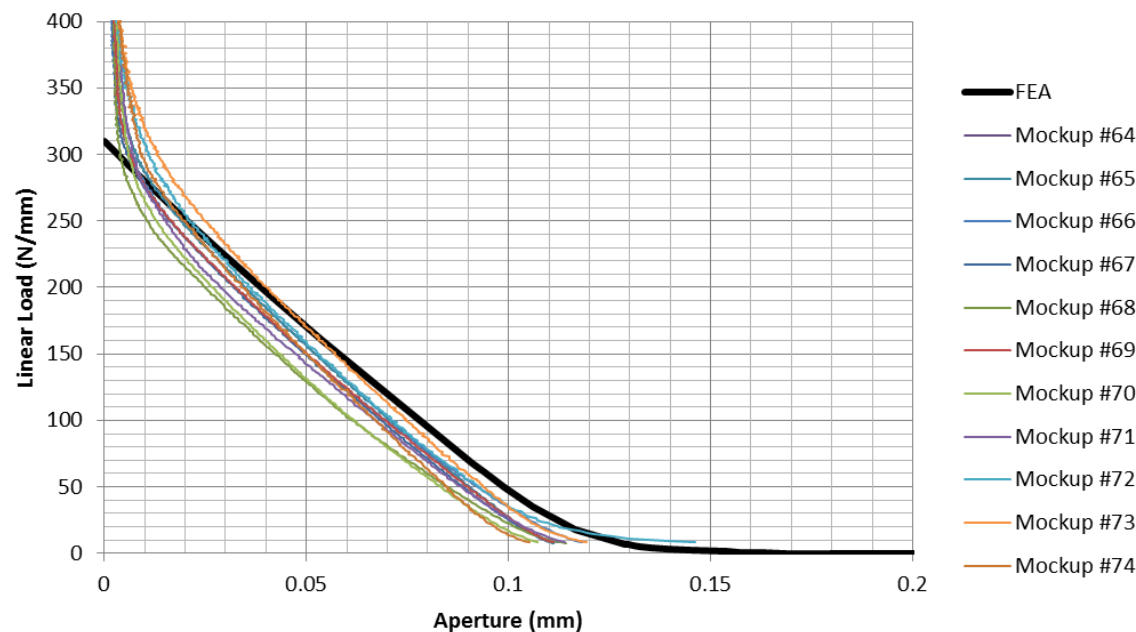

Results

- Analysis of jackets deformation and contact pressure evolution

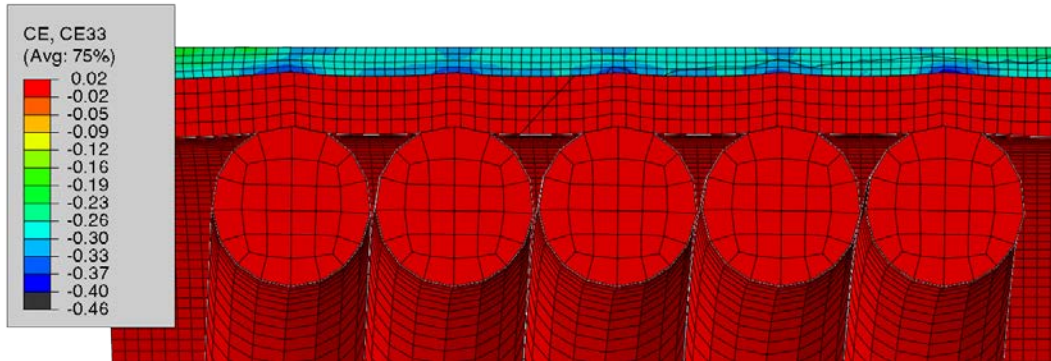

Creep strain in axial direction
after 100,000 h @ 200 °C

Residual contact pressure (MPa)

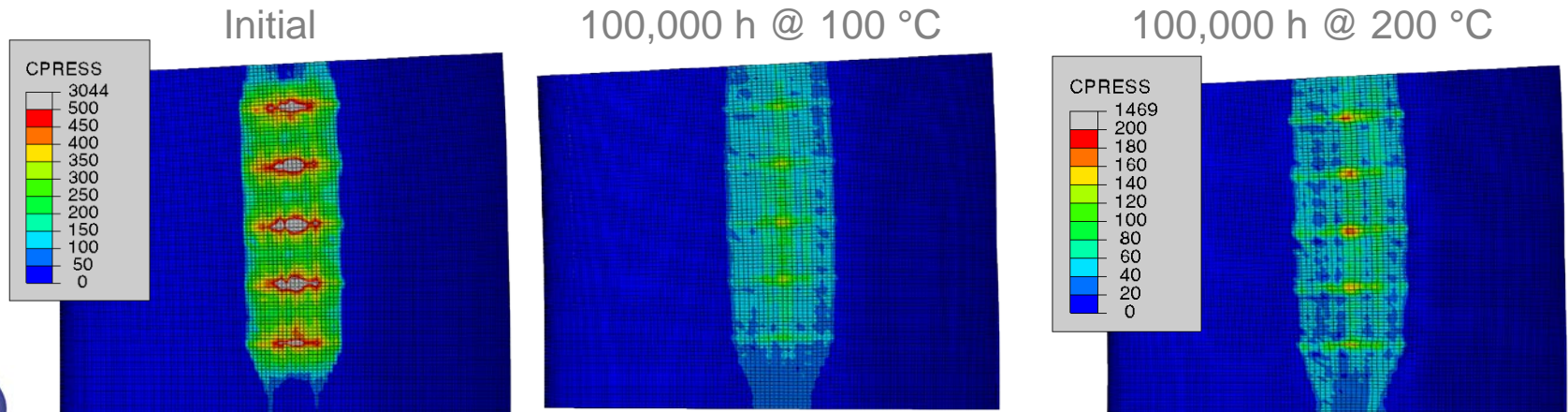

CONCLUSIONS

A numerical model of HELICOFLEX® seals with ageing is available

Comparison with experimental data highlight its relevance to analyze:

- Compression/Spring-back
- Residual Linear Load (Y2R) drop due to ageing
- Residual Spring back (RtR) drop due to ageing
- Influence of ageing scenario (temperature, time...)

This approach provide :

- Possibility to extrapolate experimental results to different seals design and ageing scenarios
- Explanation & Complements on ageing tests procedure and analysis
- New information on aged seals behavior (spring-back, deformations, contact width, contact pressure...)

Conclusions & Outlooks

- Materials behavior is now the main key to improve the simulation reliability

→ Creep tests are performed

- Simulations results and seals behavior are sensitive to:
 - Manufacturing tolerances
 - Dimensions scattering
 - Material behavior scattering
 - Uncertainties

→ A sensitivity analysis would be required to address reliability using FEA



ありがとうございます

Danke schön !

Merci !

Thank you for your
attention !

Commissariat à l'énergie atomique et aux énergies alternatives
Centre de Marcoule |
2 Rue James Watt
26700 PIERRELATTE
T. +33 (0)4 75 27 39 00

Etablissement public à caractère industriel et commercial | RCS Paris B 775 685 019

Direction de l'Energie Nucléaire
Département des Technologies du Cycle du Combustible
Service de Développement des Technologies du Cycle