



HAL
open science

Corrosion issues in pressurized water reactors : achievements and challenges

D. Feron

► **To cite this version:**

D. Feron. Corrosion issues in pressurized water reactors : achievements and challenges. NUPP 2017 - International Conference on Nuclear Power Plants Structures, Risk and Decommissioning, Feb 2017, Croydon, London, United Kingdom. cea-02437079

HAL Id: cea-02437079

<https://cea.hal.science/cea-02437079v1>

Submitted on 13 Jan 2020

HAL is a multi-disciplinary open access archive for the deposit and dissemination of scientific research documents, whether they are published or not. The documents may come from teaching and research institutions in France or abroad, or from public or private research centers.

L'archive ouverte pluridisciplinaire **HAL**, est destinée au dépôt et à la diffusion de documents scientifiques de niveau recherche, publiés ou non, émanant des établissements d'enseignement et de recherche français ou étrangers, des laboratoires publics ou privés.

DE LA RECHERCHE À L'INDUSTRIE



www.cea.fr

CORROSION ISSUES IN PRESSURIZED WATER REACTORS: ACHIEVEMENTS & CHALLENGES

NUPP 2017

1st International Conference on Nuclear Power Plants:
Structures, Risk & Decommissioning

Croydon, London, UK / 6th – 8th February 2017

Damien Féron

Service de la corrosion et du comportement des matériaux dans leur environnement

Commissariat à l'énergie atomique et aux énergies alternatives

French atomic energy and alternatives energies Commission

Saclay, France



CONTENT

Introduction: background

Corrosion issues (Pressurized Water Reactor – PWR)

- (Fuel cladding)
- Primary circuit
- Steam generator tubing
- Secondary circuits

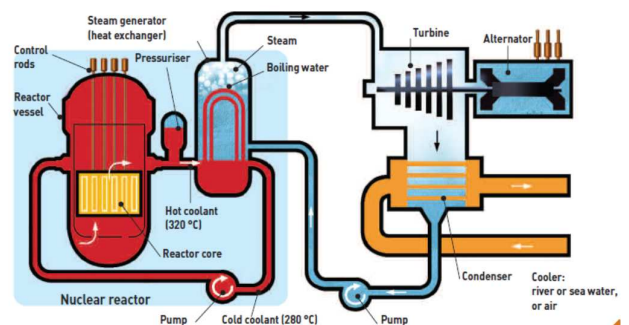

Conclusion: multiscale modelling

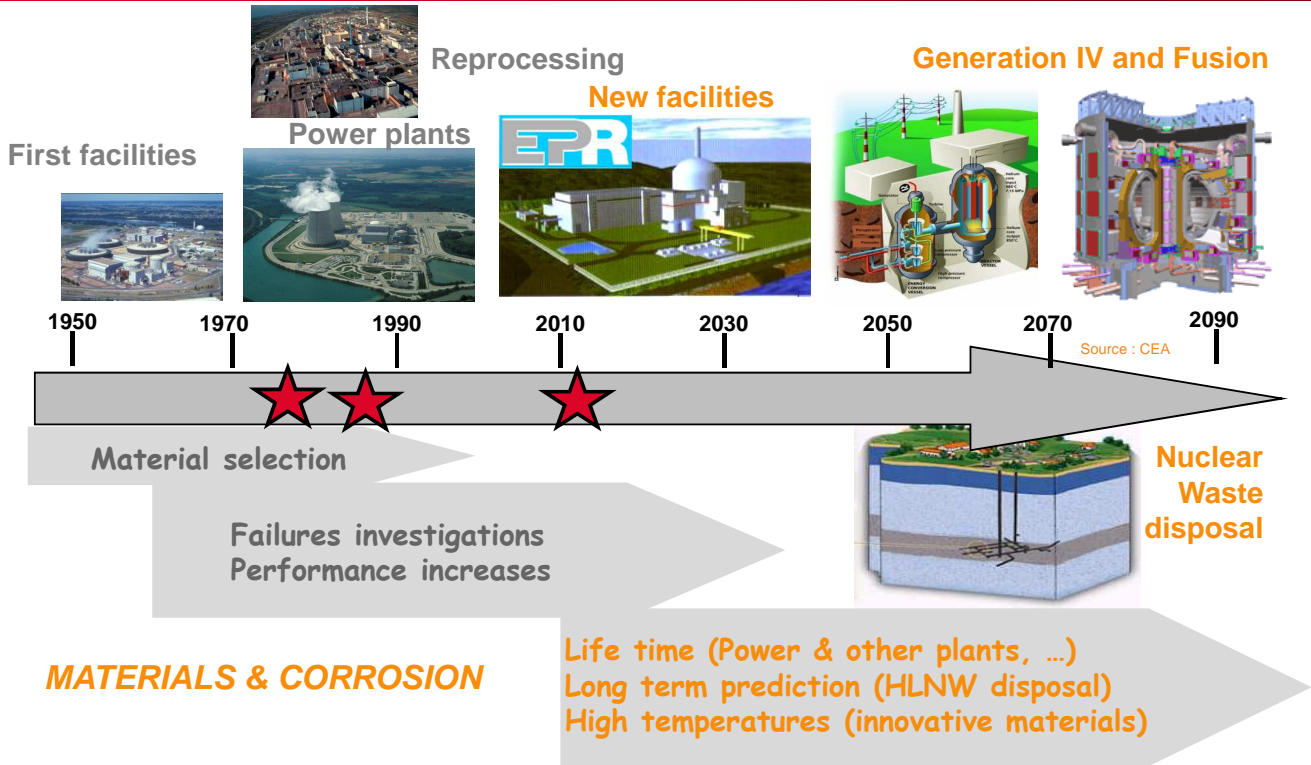

Cladding: Zirconium alloys

Structural alloys: steels and nickel base alloys

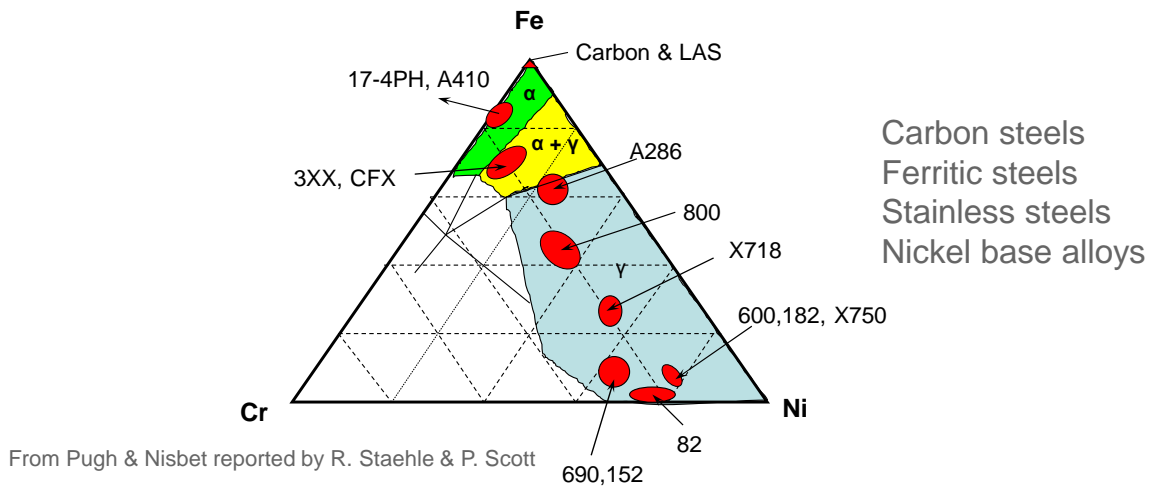

Evolution of the alloys due to corrosion issues



1- Fuel cladding : corrosion of zirconium alloys limits the residence time of fuel materials



2- Reactor coolant boundaries : pressure vessel (irradiation damages) is limited by irradiation damages, while **stress corrosion cracking of the nickel base alloys tubes of the SG** limits the life time of steam generators

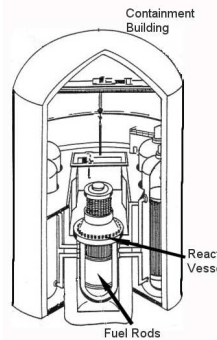
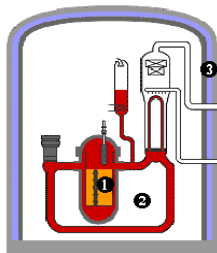

3- Reactor containment: concrete and reinforced concrete evolution (repairs possible)

OPERATIONAL EXPERIENCE & CORROSION

Events of Interest for Safety of French PWRs (IRSN, 2010)

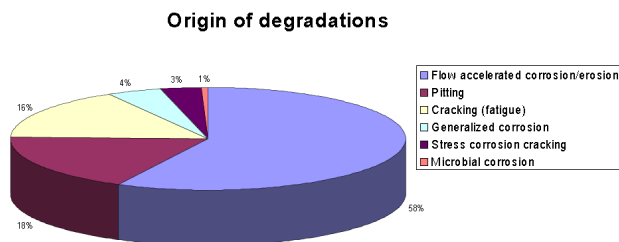

From P. Scott

Most degradation is caused by Flow Accelerated Corrosion (FAC). Stress Corrosion Cracking (SCC) is highly generic and has a large impact on safety because it appears in the second containment barrier.

Main Degradation Mechanisms leading to NPPs shutdown (R. Killian, 1995-2005)

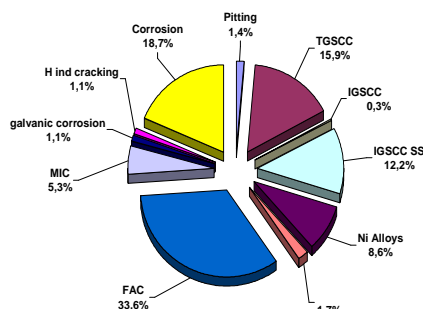

- Two main dominant mechanisms:
- Flow accelerated corrosion (FAC) and
 - Stress Corrosion Cracking (SCC)
 - Pipes and internals
 - SG tubes

PWR Primary Circuit

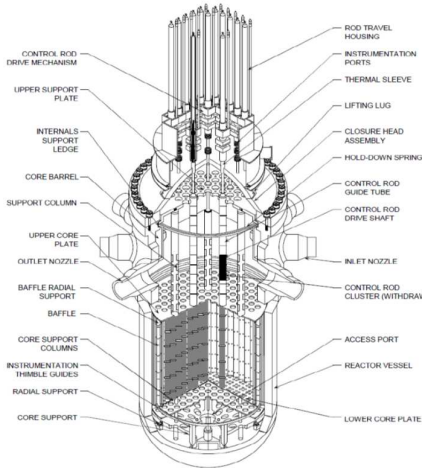
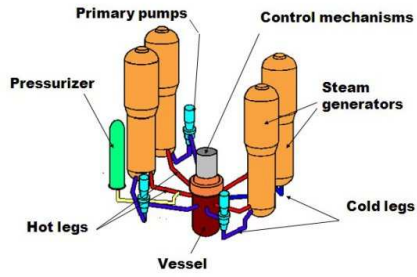

PRIMARY CIRCUIT : PIPES & INTERNALS



PRIMARY CIRCUIT: PIPES AND INTERNALS

PWR Materials

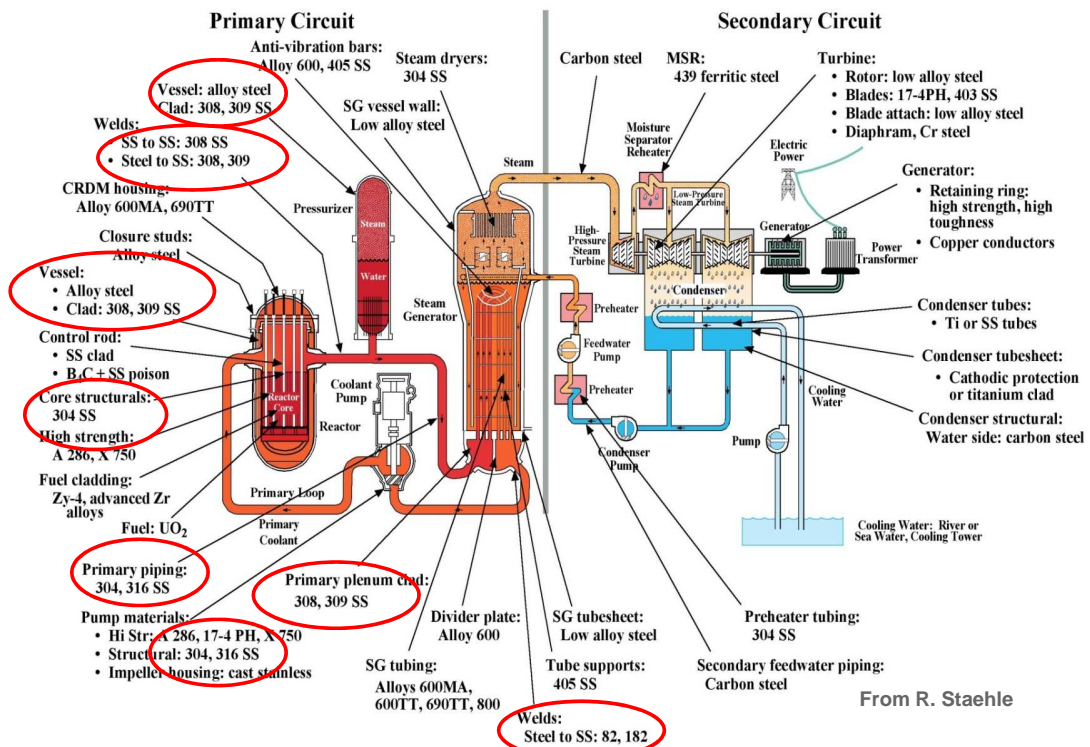

Stainless steels are widely used in PWR primary circuits

Practical experience shows that de-oxygenated, hydrogenated PWR primary water does not cause SCC. The reason is clearly related to the dissolved hydrogen in PWR primary circuits, which ensures that any radiolytic decomposition products of water are efficiently scavenged (unlike in BWRs on Normal Water Chemistry).

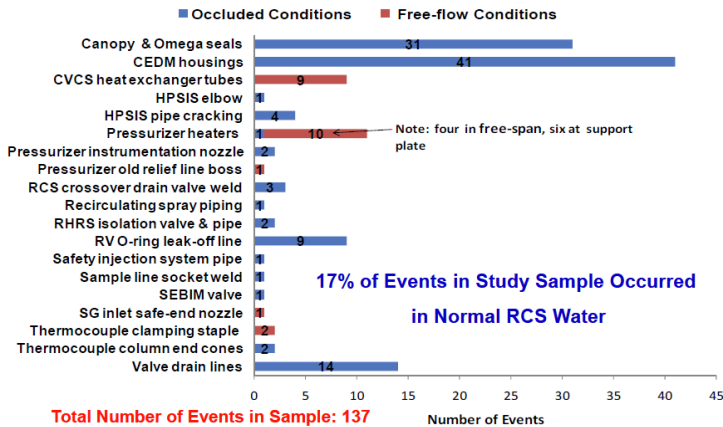

From Ilevbare & al., 2010

Stress corrosion cracking has been experienced on unirradiated stainless steels :

- Low number of events
- 83% of the events occurred in low flow or stagnant ("occluded") zones.
- 17% occurred in nominally free-flow conditions and have been associated with cold work and excessive hardness (>300 HV)

Extreme environment (irradiation, high temperatures, ...) for stainless steels

Irradiation assisted corrosion (IASCC)

Life time

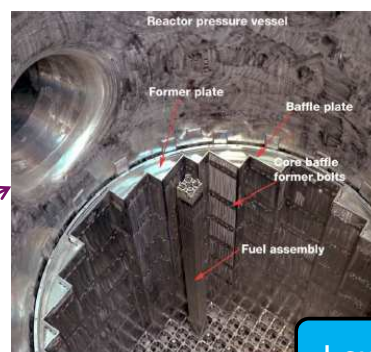
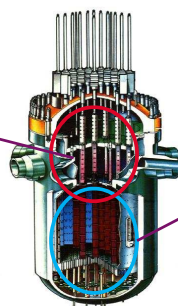
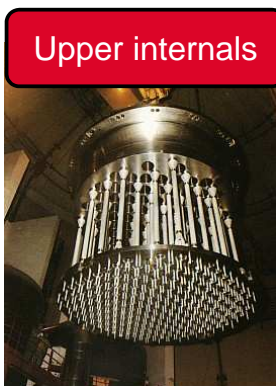

Lower internals

Objectives: to understand, to anticipate and to predict the degradation of PWR internals.

- Preventive maintenance for the replaceable components
- Extension of the operation time of the current PWRs (up to 60 years)
- Understanding the degradation phenomena
- Improvement for new PWRs (materials & design)

➤ **Irradiated Assisted Stress Corrosion Cracking**

- ❑ Cracking linked to the evolutions of the environment (radiolysis) and the materials (damages) due to irradiation
- ❑ Major influence of the dose rate

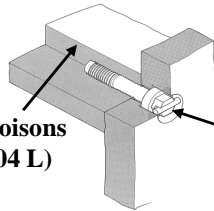
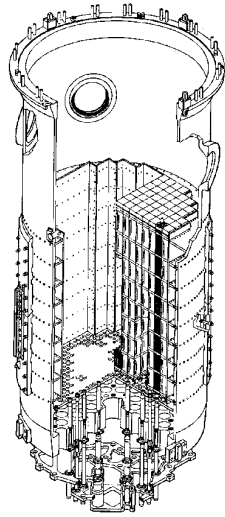

Vis (316)

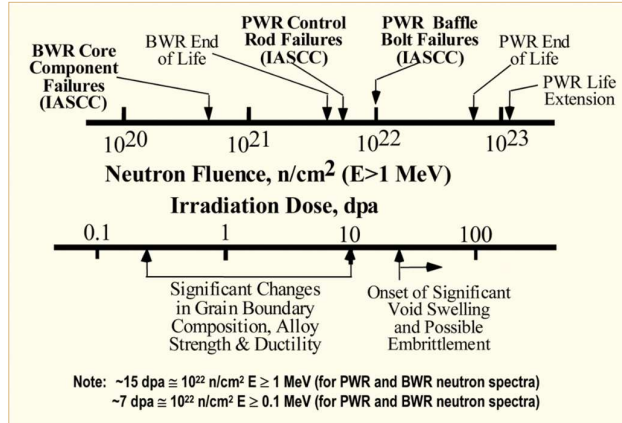

PWR primary water: 155 bar, 300-340°C, 30ccH₂/kgH₂O, 2 ppm Li, 1000ppm B



From <http://de.aveva.com>

STEAM GENERATOR TUBES

EVOLUTION OF THE MATERIAL LINKED TO CORROSION ISSUES

ALLOY 600

C \leq 0,15 %	Cr = 14-17 %	Fe = 6-10 %	Mn \leq 1%	Si \leq 0,5 %	Ni > 72 %
-----------------	--------------	-------------	--------------	-----------------	-----------

1953: Stress Corrosion Cracking occurred in the stainless steel tubing of the steam generator of the prototype for the Nautilus. SCC failures occurred on the secondary surfaces of the tubes.

By 1957, H. Copson at INCO had demonstrated that the Stress corrosion cracking of Fe-Cr-Ni alloys, when exposed to boiling $MgCl_2$, would stop above about 40% Ni.

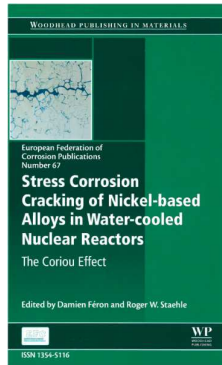

This document is CEA's property. It cannot be disclosed without prior authorization.

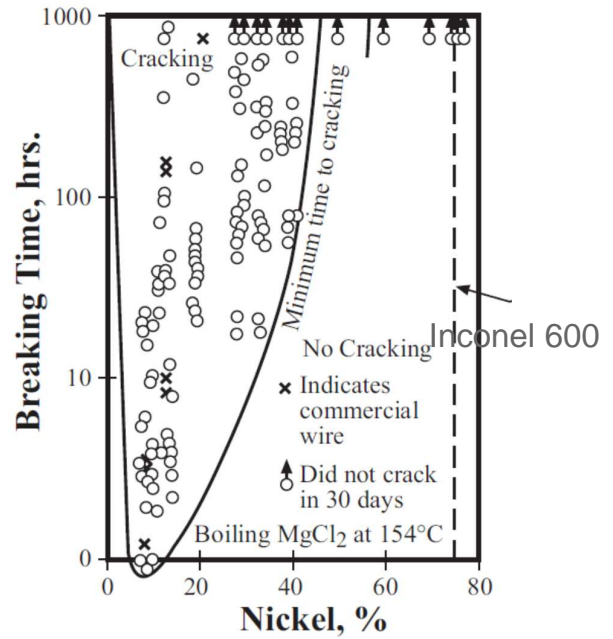

Time to failure of laboratory alloys (1963)

NUPP 2017 | Damien Féron | February 2017 | PAGE 13

“Coriou effect”

1959: *Coriou et al.* published that Alloy 600 (75% Ni & 15% Cr) is sensitive to SCC in “pure” water at 350°C.

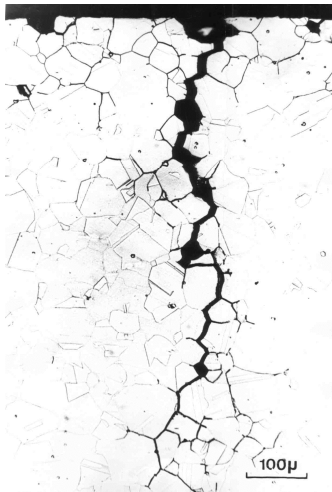

Intergranular SCC of Alloy 600 (350°C, pure deoxygenated water) – 3 months

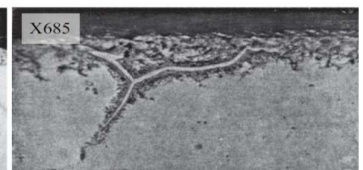
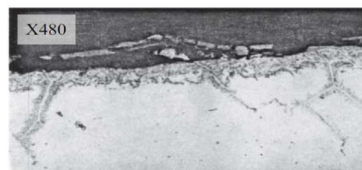
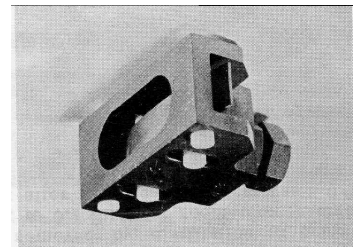
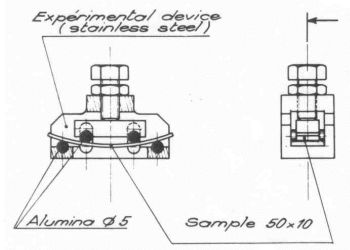

Intergranular oxidation on Alloy 600 (350°C, pure deoxygenated water, 3 months)

This document is CEA's property. It cannot be disclosed without prior authorization.

NUPP 2017 | Damien Féron | February 2017 | PAGE 14

Stress corrosion cracking susceptibility by CORIOU

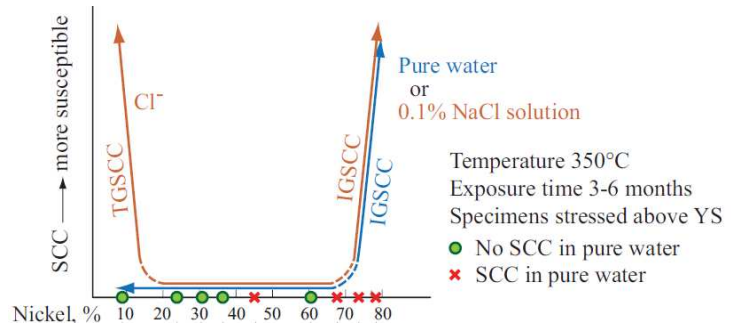
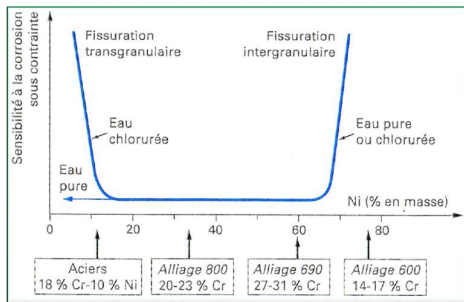

SCC susceptibility as function of the nickel content (Coriou's work – summary 1967)

Work done with a series of laboratory alloys Fe-18%Cr-Ni with various Ni content
Pure water and solution with 0.1% NaCl / 350°C / 6 months / 1.2 and 1.7 $E_{0.2}$

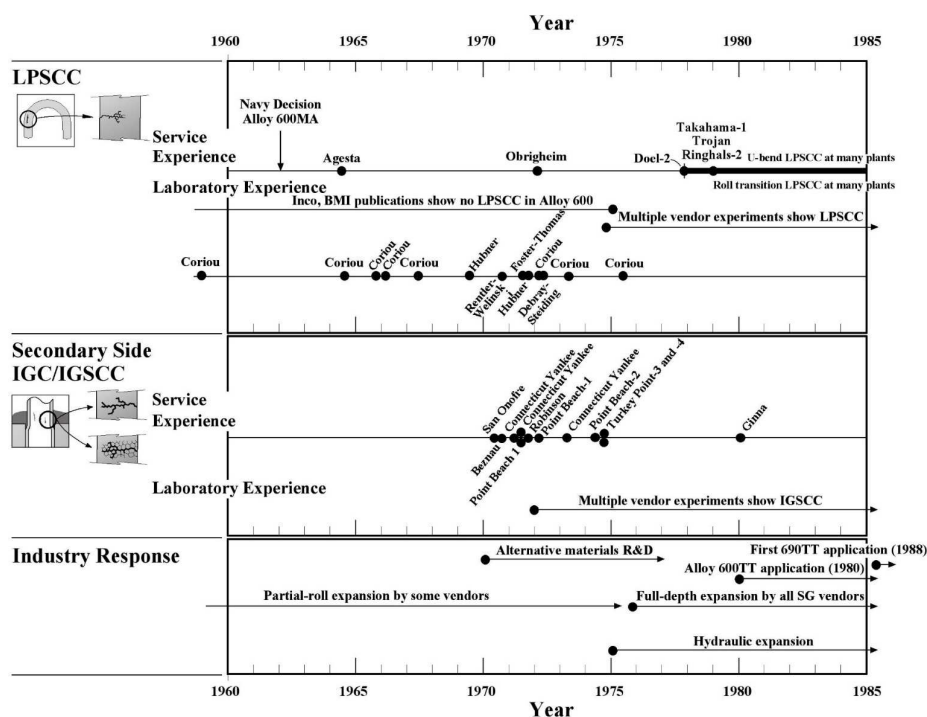

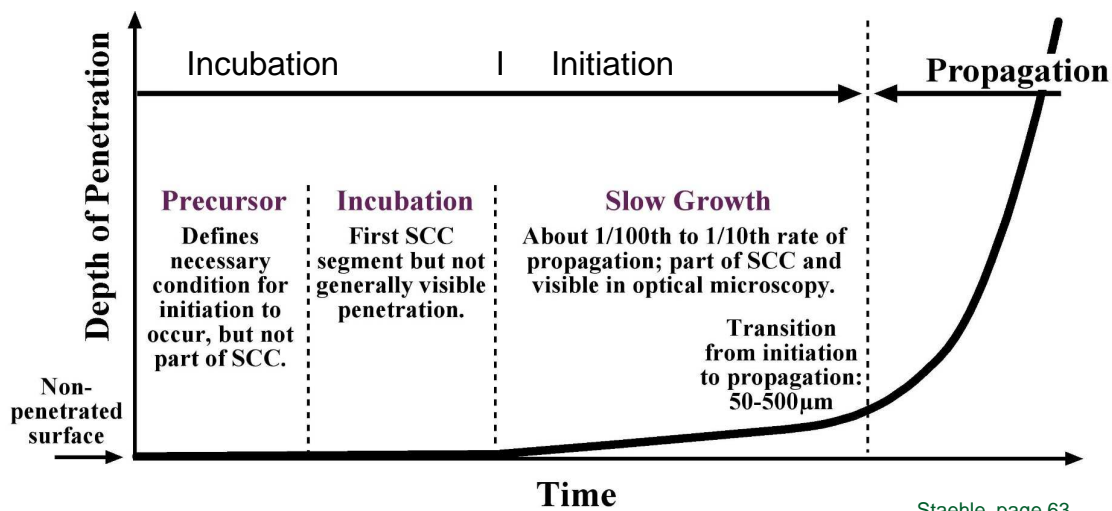

Incubation: Passive film formation and evolution

Initiation: Film rupture & Intergranular oxidation

Propagation: Internal oxidation & Hydrogen

Oxygen transport in the crack tip (nano-SIMS and tracers)

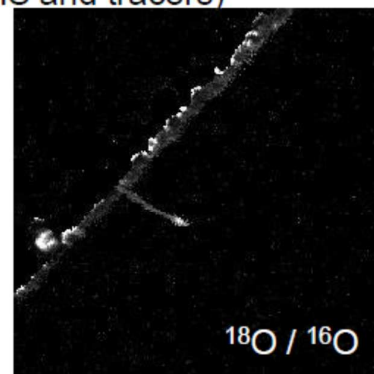
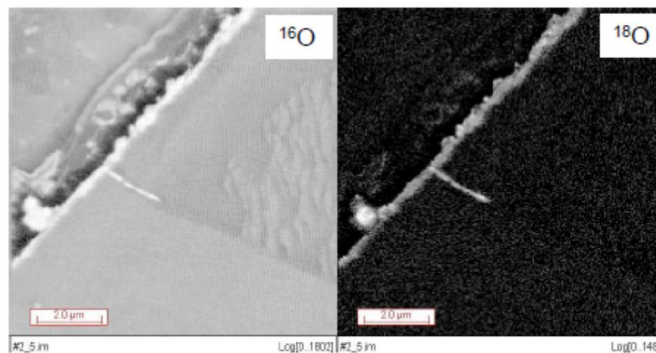

Laghoutaris, page 319

Solution-annealed material (no intergranular carbide)

1340 hr in nominal primary water + primary water containing tracers (deuterium and ^{18}O) for 67 hr

-> ^{18}O is located at the tip of the IG penetration and in the outer part of the surface oxide layer, where the oxide growth occurs.

-> ^{18}O diffusion occurs during the second stage of the test in 67 hr

-> estimate of the oxygen transport coefficient : $> 10^{-13} \text{ cm}^2 \cdot \text{s}^{-1}$

Oxygen transport up to the crack tip is not a rate limiting step.

8 février
2017

- Two series of experiments were done, in which the specimens are exposed to:
- a PWR primary medium in which the water is replaced by deuterated water D₂O (D content 97.90%) , pressurized by classical hydrogen gas (H₂)
 - a classical primary medium (with H₂O), pressurized by deuterium gas (D₂) (D content 99.05%).

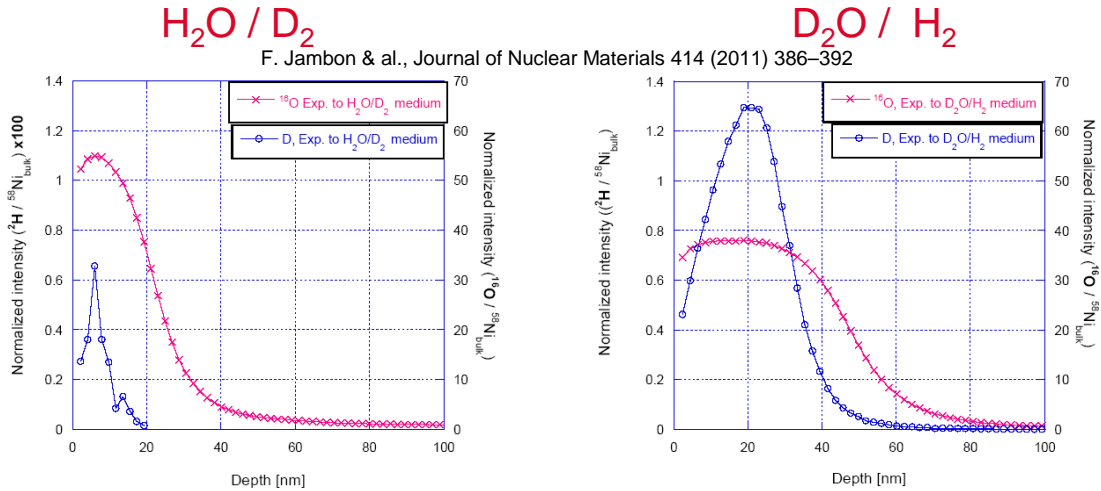

Hydrogen absorption is associated with the cathodic reaction
 $(\text{H}_2\text{O} + \text{e}^- \rightarrow 1/2\text{H}_2 + \text{OH}^-)$

19

❑ Large progress on mechanisms

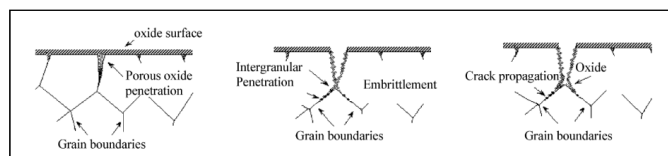

Internal oxidation model with an eventual influence of the cathodic hydrogen in grain bound

- ❑ Steam generator tubes are no longer made of Alloy 600 MA or alloy 600TT
- ❑ Good behavior of Alloy 690 and Alloy 800 linked to the higher chromium content

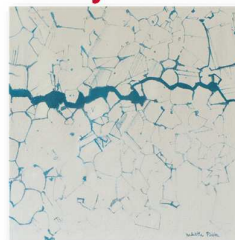

Artist's view of the Coriou's crack,
by Juliette Plisson

PWR SECONDARY CIRCUITS

FLOW ACCELERATED CORROSION (FAC) & CARBON STEELS

Main susceptible FAC systems

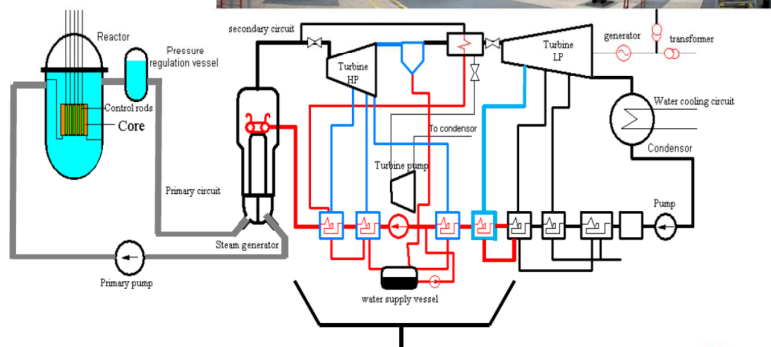

BRIEF HISTORICAL BACKGROUND OF FAC

INTERNATIONAL



12/02/1995
Pleasant Prairie
(Fossil Plant 600 MW, USA)

2 persons died

09/08/2004 - MIHAMA 3 (Japon)
Tube leakage downstream diaphragm

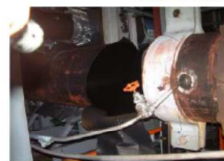

5 persons died

09/05/2007 – IATAN
(Fossil Plant, USA)

2 persons died



FRANCE

(No death)

2000
Fessenheim 2
Important wear on expander downstream regulating valve on low Flow Rate Feedwater lines

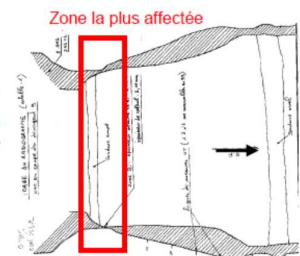

Since 2001

BRT-CICERO™ is used on all units in France



2002
Flamanville
Tube support plates degradation on AHP 500 heaters

Electrochemical based phenomena accelerated by flow rate
(and not mechanically – erosion / abrasion)

- Metallic materials in contact with liquid water at high flow rates
- Carbon steels (CS) or low Alloyed Steels (LAS) covered with a protective layer magnetite / hematite (passive layer)
- Stationary conditions: $V_{\text{film formation}} = V_{\text{oxide dissolution}}$
- High flow rate
 - Oxide dissolution is faster
 - Oxide film thickness is decreasing
 - Corrosion rate is increasing

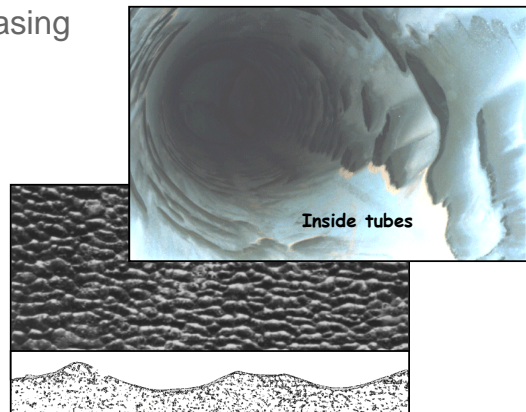
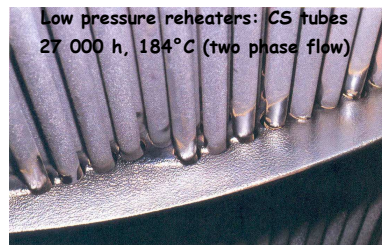
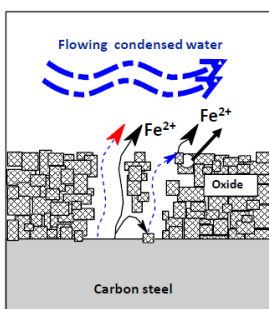

This document is CEA's property. It cannot be disclosed without prior authorization.

NUPP 2017 | Damien Féron | February 2017 | PAGE 23

The flow accelerated corrosion rate decreases when pH increases (iron solubility decreases when pH increases)
Importance of the chemical agent (linked to the formation of complexes)

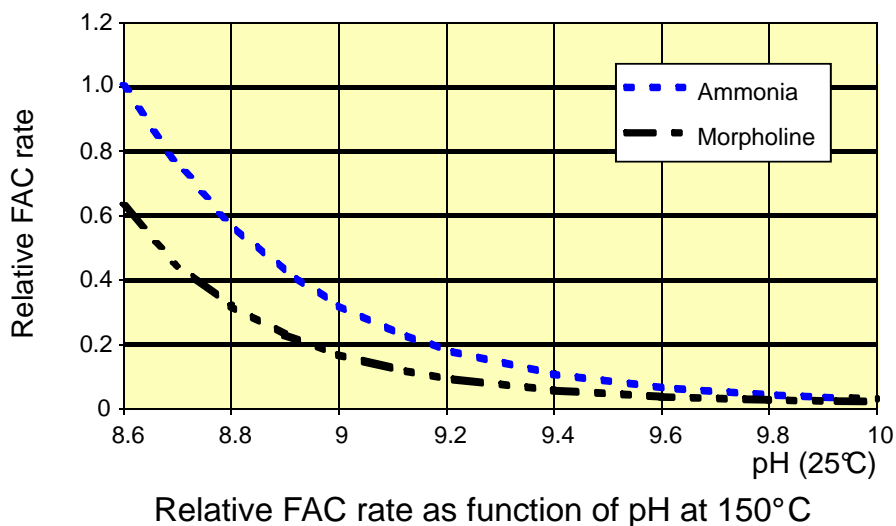

This document is CEA's property. It cannot be disclosed without prior authorization.

NUPP 2017 | Damien Féron | February 2017 | PAGE 24

With only 0,5% of chromium in the steel, the FAC rates are decreased by a factor of 10 at least

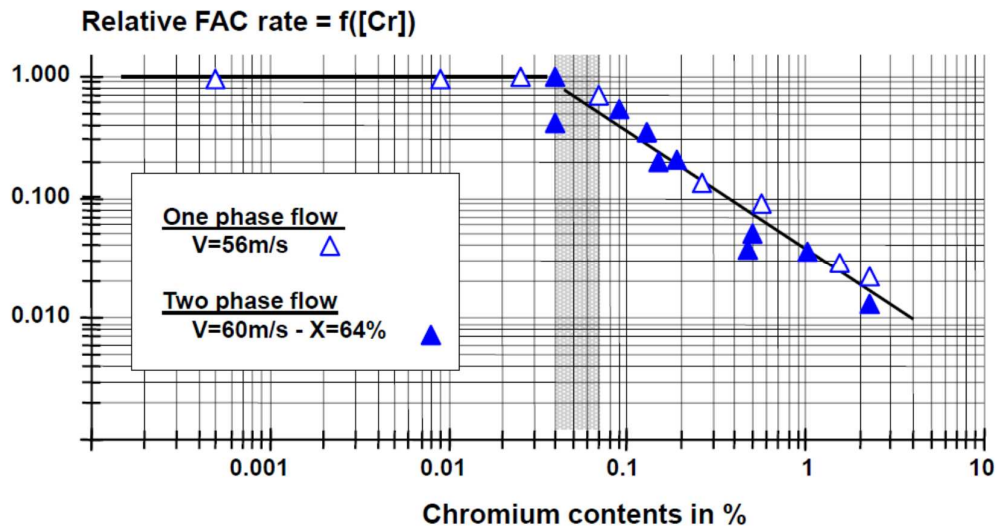

Plants	equipment where the feed water flows in	material improvement	water chemistry pH	improvement [O ₂]	remarks
PWR	steam generator	increasing [Cr]	increasing pH	AVT(H&O)	minimizing [O ₂] at SG inlet
BWR	reactor core	increasing [Cr]	- (neutral)	oxygen injection	[O ₂] generated due to radiolysis
Fossil	boiler	increasing [Cr]	increasing pH	AVT(O) OT	From S. Uchida & al., FAC2013

⇒ Importance of the design of the components, **modeling and prediction of degradations (COMSY, BRT-CICERO, WATHEC, CHECWORKS...)** coupled with non-destructive examinations.

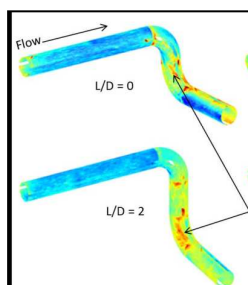

CONCLUSION

Corrosion issues lead to evolutions of materials

- SG tubes: Alloy 600 to Alloy 690
- FAC: from carbon steels to low alloyed steels (LAS – less than 1%Cr)

MODELLING & SIMULATION

DE LA RECHERCHE & L'INDUSTRIE



MULTISCALE MODELING

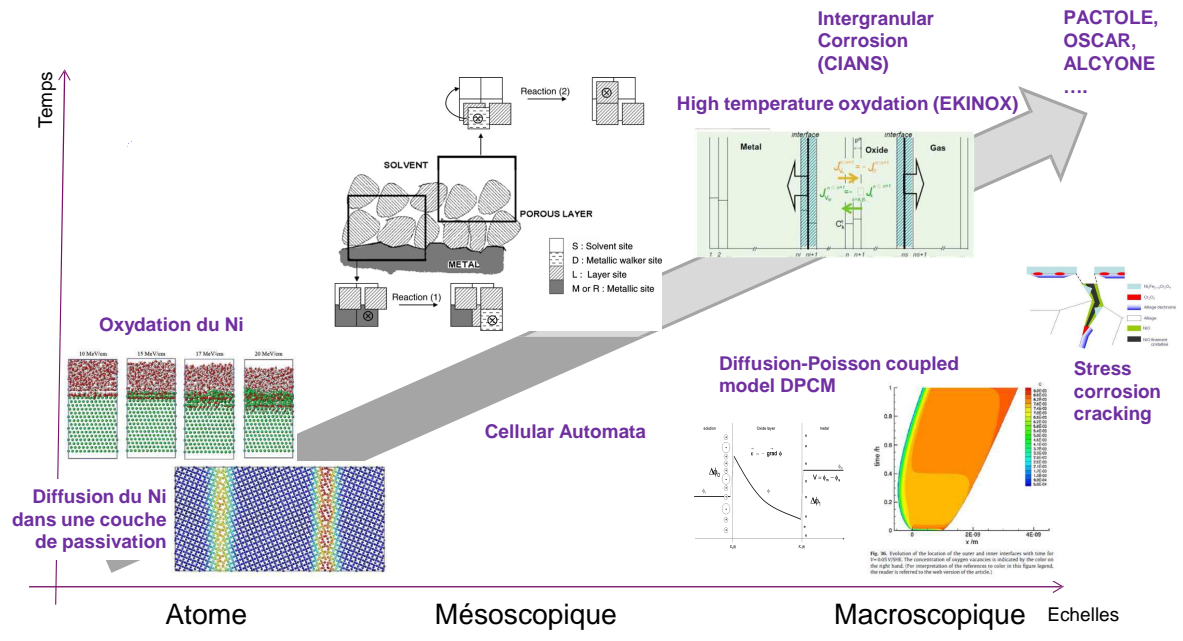

- ⇒ Needs to replace semi-empirical models by more phenomenological models
- ⇒ Multiscale modeling is then needed
- ⇒ Strategy for homogenization & harmonization

SCC: Influence of hydrogen on crack propagation

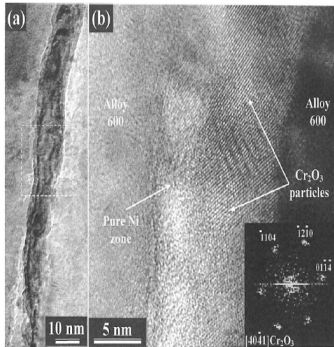

P. Laghoutaris & al., JNM 393 (2009) 254–266

- Molecular dynamic simulation: LAMMPS
- Interatomic potential: EAM (type)
- 750 000 atoms (Ni)
Ductile crack without H
Brittle crack with H

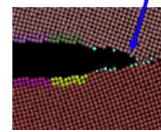
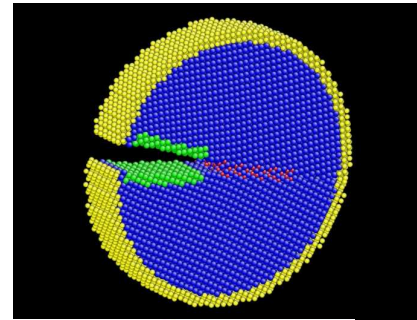

Brittle crack without dislocation nor amorphization

Dislocation

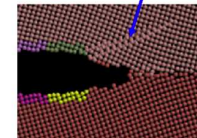

P. Arnoux, Corrosion Science 52 (2010) 1247–1257
Confirm by Cornell & Zamora, Physical Review B, 060101 (R) 2012,

Molecular simulation of the oxidation by water of Ni (hydrogen in the metal from the cathodic reaction)

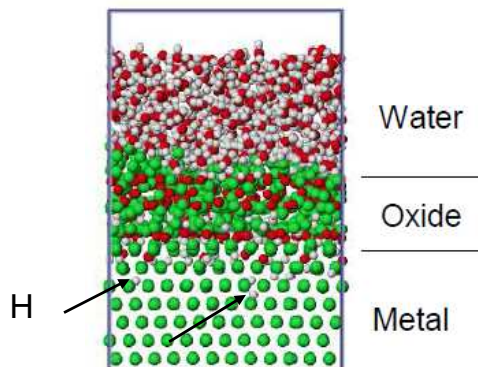

From B. Diawara & Al., Winter School, Modelling of corrosion, December 2011

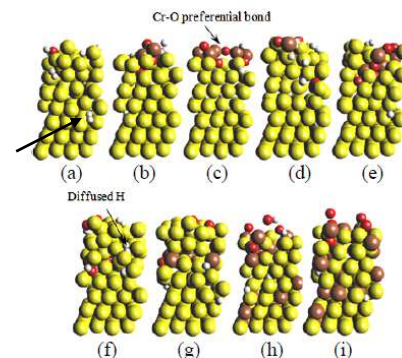

Same results on Cr
N.K. Das & T. Shoji, SNA-MC, Paris, November 2013

Atomistic simulation of oxidation & experimental observations in agreement



Atoms & molecules by Juliette Plisson

Copyright: Département de Physico-Chimie (CEA/DEN/DANS/DPC)

Thank you