



**HAL**  
open science

## Main operation procedures for ASTRID gas power conversion system

D. Barbier, G. Mauger, D. Plancq, N. Tauveron, J. M. Cherel, Y. Quenaut, B. Levoir, D. Abdo, D. Settimo

► **To cite this version:**

D. Barbier, G. Mauger, D. Plancq, N. Tauveron, J. M. Cherel, et al.. Main operation procedures for ASTRID gas power conversion system. IAEA conference on fast reactors (FR17), IAEA, Jun 2017, Yekaterinburg, Russia. pp.PAPER n° 468. cea-02435067

**HAL Id: cea-02435067**

**<https://cea.hal.science/cea-02435067>**

Submitted on 10 Jan 2020

**HAL** is a multi-disciplinary open access archive for the deposit and dissemination of scientific research documents, whether they are published or not. The documents may come from teaching and research institutions in France or abroad, or from public or private research centers.

L'archive ouverte pluridisciplinaire **HAL**, est destinée au dépôt et à la diffusion de documents scientifiques de niveau recherche, publiés ou non, émanant des établissements d'enseignement et de recherche français ou étrangers, des laboratoires publics ou privés.

## Main operation procedures for ASTRID gas power conversion system

D. Barbier<sup>1</sup>, G. Mauger<sup>1</sup>, D. Plancq<sup>1</sup>, N. Tauveron<sup>1</sup>,  
J.M. Cherel<sup>2</sup>, Y. Quenaut<sup>3</sup>, B. Levoir<sup>4</sup>, Diala Abdo<sup>4</sup>  
D. Settimo<sup>5</sup>

(1) French Alternative Energies and Atomic Energy Commission (CEA), F- 13 108 Saint Paul Lez Durance, France

(2) AREVA NP, Lyon, France

(3) General Electric, Baden, Switzerland

(4) NOX, Ivry sur Seine, France

(5) EdF Septen, Villeurbane, France

E-mail contact of main author: dominique.barbier@cea.fr

**Abstract.** Until the end of the first part of the basic design phase (2017), the ASTRID project has made the choice of studying a power conversion system (PCS) based on a Brayton cycle with nitrogen as coolant. The justification is related to a safety and public acceptance considerations in order to inherently eliminate the sodium-water and sodium-water-air reactions risks. The objective of the studies engaged is to enhance the level of maturity of the gas PCS. The choice of two PCS of 300 MWe each has been made in order to limit the gas inventory, the size and length of gas pipes as well as maintaining a high level of availability.

This paper presents specific operating procedures as start-up and normal shutdown of the plant, scram, rapid shutdowns, gas inventory control system, house load and grid frequency control. The current procedures of the plant and the expected regulation are presented. A focus will be made on the nitrogen inventory control which takes part of the electric power regulation provided to the grid.

Finally some perspectives of remaining operation studies to be performed until the end of 2017 will be presented. Indeed the level of maturity of the gas PCS must be at a similar level than the classic water-steam Rankine cycle in order to make the best choice for the future of the sodium fast reactors in terms of better cost-effectiveness and reliability through optimization of the Brayton cycle technology and operations.

**Key Words:** ASTRID, gas, PCS, operations

### 1. Introduction

The Sodium-cooled Fast Reactor (SFR) is one of the Generation IV reactor concepts selected to secure the nuclear fuel resources and to manage radioactive waste. Within the framework of the June 2006 act on the sustainable management of radioactive material and waste, the French Government asked CEA to conduct design studies for the Advanced Sodium Technological Reactor for Industrial Demonstration (ASTRID) project [1] in collaboration with industrial partners [2].

ASTRID will be an integrated technology prototype designed for industrial-scale demonstration of 4<sup>th</sup>-generation Sodium-cooled Fast Reactor (SFR) safety and operation

aiming at improving safety, operability and robustness levels against external hazards compared with previous SFRs.

The pre-conceptual design phase – AVP1 conducted from mid-2010 to the end of 2012 – has been focused on innovation and technological breakthroughs, while maintaining risk at an acceptable level. This phase was followed by the AVP2 conceptual design phase planned until the end of 2015 whose objectives were to focus on the design in order to finalize a coherent reactor outline and to finalize by December 2015 the Safety Option Report. The ASTRID conceptual design is based on a sodium-cooled pool reactor of 1500 MWth with an intermediate circuit in sodium generating about 600 MWe. Two Power Conversion Systems (PCS) were studied in parallel during the AVP2 conceptual design phase: a Rankine steam cycle and a Brayton gas cycle.

The closed Brayton gas PCS option has been considered as the likely choice for High Temperature Reactors (HTR), as it provides at 800°C temperature range better cycle net efficiency than the best Rankine cycle. Application of Nitrogen closed Brayton cycle for a sodium cooled fast reactor in the 500°C temperature range is mainly justified for safety and acceptance considerations by inherently eliminating the sodium-water reaction risk existing in a Rankine cycle.

During the ASTRID AVP2 phase from 2013 to 2015, a strong R&D effort was focused on the gas PCS in order to increase its maturity level in order to bring it at the end of 2017 to a similar level compared to the Rankine cycle with a well-documented comparison between the two systems will be therefore facilitated [3].

The 2016-2017 phase, in which the Gas PCS is integrated in the overall layout of the reactor, will allow to better specify the technical and economic assessments of the gas PCS.

This paper discusses operation studies of the Gas Power Conversion System coupled with the Astrid nuclear island. This includes the regulation principle, normal start-up and shutdowns, the SCRAM and the rapid shutdown, the house load and an innovative procedure for the frequency load regulation. A focus will be made on the gas inventory system to master the changes of the output power

## 2. Brayton cycle description:

At the end of the AVP2 Phase (2013-2015), the reference cycle for the ASTRID Power Conversion System is closed Brayton cycle in pure nitrogen at 180 bar (*FIG 1*). The plant is composed with 2 GTA (group turbine alternator) with a thermal power of 750 MWth each. The turbine and the compressors are placed on the same shaft line as the turbogenerator. Aiming at optimizing the cycle, the gas is cooled before the high pressure compressor inlet to limit the compression work and an economizer allows raising the temperature of the gas returning to the Sodium Gas Heat Exchangers (SGHE) with heat extracted from turbine outlet gas. The reference solution for the heat sink is a wet cooling tower. The closed cooling water system provides the cooling medium for the pre-coolers and coolers.

The main boundary conditions for the thermodynamic gas cycle calculations are the following:

- Thermal power delivered to the gas cycle (2 GTA): 1502 MWth
- Sodium gas heat exchanger outlet temperature: 515°C
- Sodium gas heat exchanger outlet pressure: 180 bar
- Sodium gas heat exchanger inlet temperature: 310°C
- Cooler outlet temperature: 27°C

The expected gross efficiency at the end of the AVP2 phase (2013-2015) is around 37.4 %, not taking into account auxiliary power [4].

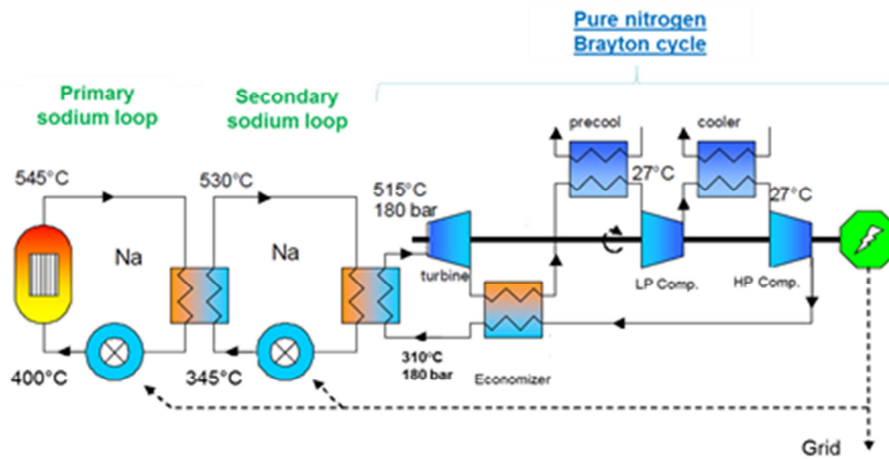

FIG.1. AVP2 Reference Brayton cycle

### 3. Regulation principle:

#### 3.1. The overall control

The control of the gas PCS is designed to regulate the main operating parameters of the cycle, while limiting the use of the bypasses on the gas PCS (FIG.2), namely:

- Regulate the sodium temperature at the outlet of the ECSG (ECSG by-pass);
- Rapidly varying the electrical power and then regulating it around a set value (by-pass 1),
- Regulate the speed of the turbomachine at its nominal value due to power changes (by-pass turbine).

During power operation, the gas flow cannot be adjusted by varying the speed of rotation of the turbomachine, set by the frequency of the network (3000 rpm); It is adjusted by a nitrogen inventory management system for each GTA, allowing the scheduled power variations(cf § 6).

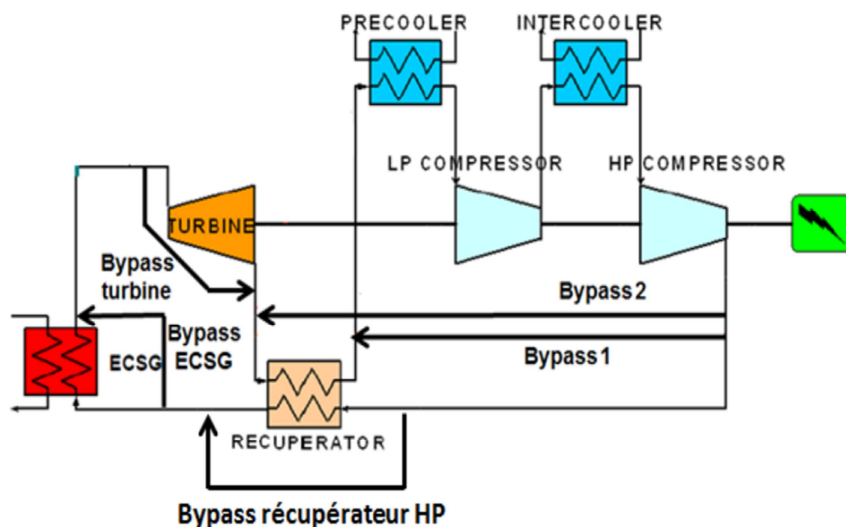

FIG.2: Scheme of several by passes tested on Brayton cycle

#### 4. CATHARE code description:

All results given hereunder in this paper are issued from the V2.5 CATHARE system code. This version is the outcome of more than 30 years of joint development effort by CEA (French Atomic Energy Commission), EDF (Electricity of France), AREVA and IRSN (Radio-protection and Nuclear Safety Institute).

CATHARE is a system code originally devoted to best estimate calculations of thermohydraulic transients in Water-Cooled Reactors such as PWR, VVER or BWR.

The two-fluid model with non-condensable gases transport equations, with light water as the main fluid, was extended to GCR, SCWR, (IAPWS tables) SFR (with Na sodium as main fluid) and for non-nuclear industrial applications such as cryogenic rocket engines

CATHARE code has now a multi-purpose multi-reactor concept system code as it has many advantages to be extended easily to other applications:

- The numerical solver is reliable, efficient and generic
- The existing tools for pre-processing and post-processing can be used for all applications,
- Basic modeling features, like circuits with heat exchangers, various hydraulic elements, valves, walls, already exist, are well consolidated, and can be re-utilized.

The code is used for research, safety and design purposes in France by about 50 full time scientists and is released abroad in about 30 foreign institutes. The applications are mainly for:

- \* plant system and component designs,
- \* the definition and verification of emergency operating procedures,
- \* investigations for new types of core management, new reactors and systems designs,
- \* the preparation and interpretation of experimental programs,
- \* for safety analysis, a methodology has been developed in order to evaluate uncertainties of the code calculations.

#### 5. Normal start-up and shut down:

The main functional specifications and procedures for the start-up and shutdown phases of ASTRID plant with a gas PCS have been established in order to preserve the kinetics and the control capacities similar to those obtained with a steam Rankine PCS. The procedures can be carried out either on 1 or simultaneously 2 GTAs and, unlike the full power operation connected to the grid, the gas flow can be adjusted by varying the speed of rotation of the turbomachine.

The main phases of a start-up from the cold state (200 deg.) are as follows (*FIG. 3*):

- preheating, divergence and beginning of isothermal rise of temperature,
- starting of the turbomachine and preheating the PCS gas,
- during the isothermal rise, increase of the gas flow rate by increasing the rotation speed of the turbomachine (with successive steps from 1000 rpm and then 1500 rpm) and simultaneously by gradually increasing the nitrogen inventory in the PCS,
- coupling to the network when the speed of the turbomachine reaches 3000 rpm,
- increasing of the power up to 100% P<sub>nom</sub>. (nominal power) keeping a kinetic adjusted to limit the thermal solicitations of the primary circuit structures.

For the normal shutdown, the different phases are as follows:

- power reduction from 100% PN to 20% PN according to kinetics faster than start-up and simultaneously reduction of gas flow by reduction of nitrogen inventory,
- rapid shutdown (motorized drop of control rods), decoupling to the network and switch of the turbomachine in motor mode (inversed supplied of the alternator),
- decreasing the gas flow by reducing the speed of the turbomachine and reducing the PCS nitrogen inventory to regulate the primary circuit temperature as a function of the residual power.
- Continuing cooling to the cold state.

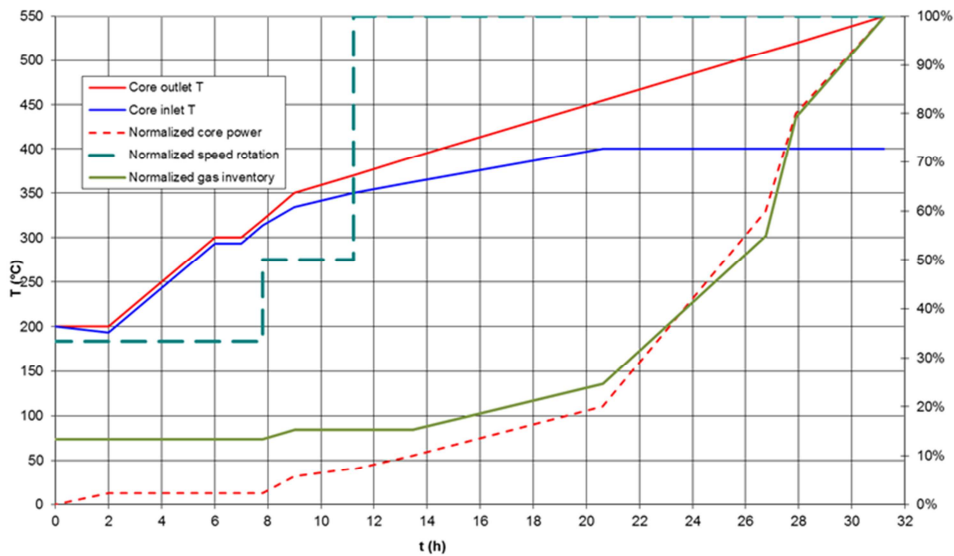

FIG 3: Operating parameters evolution during a normal shutdown

## 6. The nitrogen inventory gas control:

In order to manage the start-up, the shutdown and other specific sequences, the quantity of nitrogen contained in the Brayton Cycle (130 tons), so called Gas Inventory, can be withdrawn from the High Pressure level of Brayton cycle or injected to the Low pressure level of Brayton cycle thanks to the Gas Inventory Management System (FIG 4).

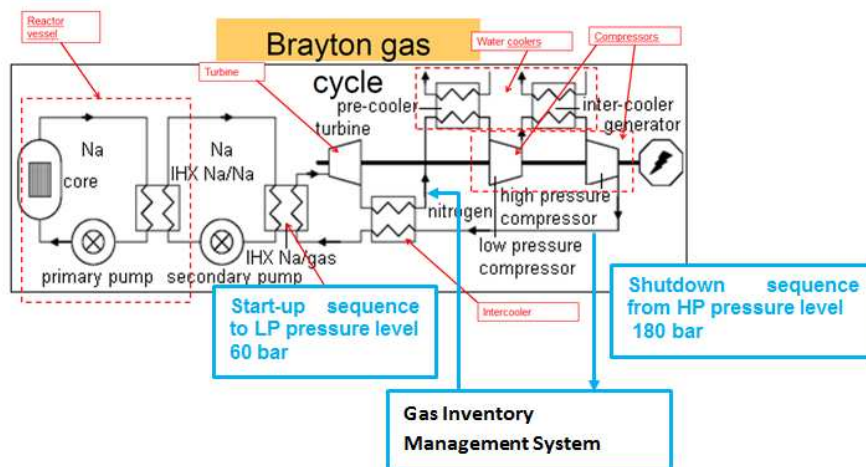

FIG 4: Scheme of gas inventory management system

During the first phase of the start-up or shutdown sequences, nitrogen is transferred by direct pressure letdown and when pressure is at equilibrium, the transfer is finalized with gas compressors (FIG. 5). The Gas Inventory Management System is composed with 6 large gas storage vessels (600 m<sup>3</sup> under 50 bar each, implemented on the ground floor of the Brayton Cycle Building, below the Brayton Cycle Hall) and a set of gas compressors (implemented in a dedicated building).

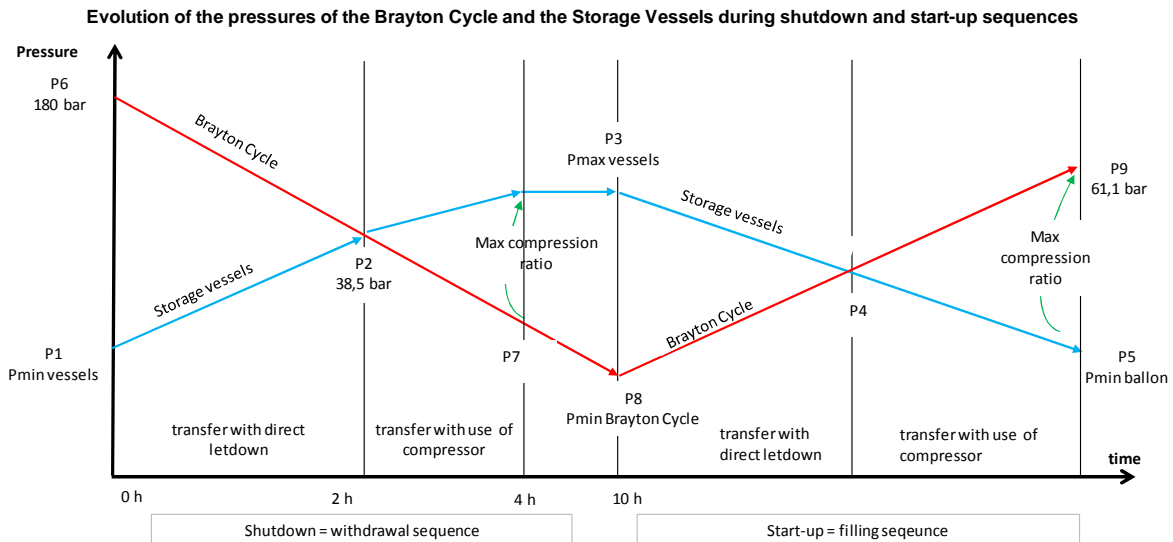

FIG 5 : Evolution of the pressures of the cycle and the storage vessels during shutdown and start-up sequences

In addition, a liquid nitrogen storage unit, and a set of nitrogen cylinders under 200 bar, allow to perform first filling and continuous make-up (to compensate leakage) of the Gas Inventory.

In a next phase of studies it will be examined the possibility to use the Gas Inventory Management System to control permanently the pressure of Brayton Cycle by nitrogen withdrawal and/or re-injection.

## 7. SCRAM and rapid shutdown procedures:

In case of unscheduled shutdown of the reactor, the procedures of SCRAM (gravity falling of control rods due to safety purpose) or rapid shutdown (motorized insertion of the control rod mainly due to initiating event from secondary or tertiary circuit) are triggered.

Both procedures exhibit similar kinetics of power transfer to the gas PCS; For the SCRAM procedure (FIG 6):

- on SCRAM signal, opening of bypass 1 in order to gradually reduce the electrical power produced by the PCS before disconnection from the electricity network,
- in the short term (about 75 s), maintaining the rotation speed of the turbomachine at its nominal speed as long as the alternator of the GTA remains in a power production mode (3000 rpm and positive power balance on the shaft); During this phase, the opening of the bypass 1 allows a first reduction of the gas flow in the ECSGs, thus anticipating the reduction of the thermal power coming from the primary circuit due to the stopping of the nuclear power,
- as soon as the alternator goes into engine mode, the speed of rotation of the turbomachine is slowed down to a folding speed (from 1000 to 1200 rpm) to minimize as much as possible the

power consumed in motor mode ( $\sim 1$  MW); The duration of this ramp is around 200 s (comparable to that applied simultaneously to the secondary flow), then keeping of the turbomachine at this speed rate with by the generator in motor mode.

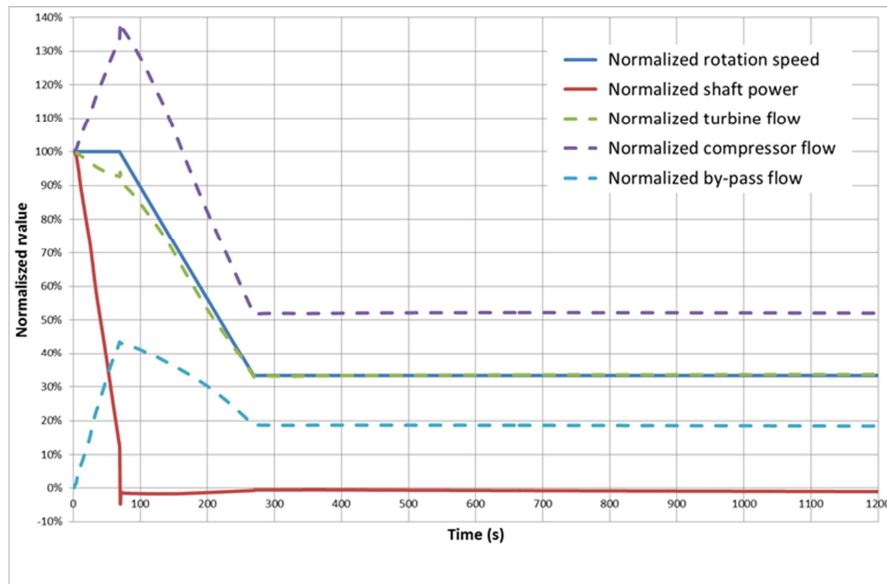

FIG.6: Evolution of the shaft speed and flowrate(normalized by its nominal value) during a SCRAM.

The regulation of the sodium temperature at the outlet of the ECSGs, ensured by the bypass of the heat exchanger (*FIG. 7*) allows to reach the setpoint temperature corresponding to the hot shutdown condition (320 deg.) at the end of the procedure.

In parallel with this regulation, the inventory reduction is carried out so as to adapt the gas flow to the level to the residual power to be evacuated, which also leads to further reduction of the power required for the rotation of the turbomachine.

In case of a failure leading to the loss of one GTA, the rapid shutdown procedure can also be performed on the remaining GTA.

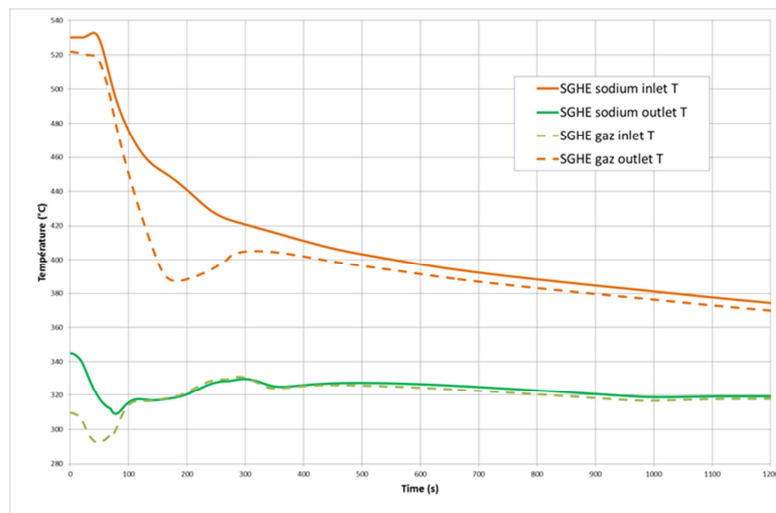

FIG 7 : Evolution of inlet and outlet ECSG temperature during a SCRAM.



## 8. House load procedure:

The house load transient is triggered just after a confirmed loss of electrical supplies which necessitates to quickly reduce the plant electrical output power produced in order to match it to the level of power required by the auxiliaries ( $\sim 7\%$  nominal output electric power) to maintain the whole plant in operation. This must be done under the required conditions of frequency and voltage to avoid risk of procedure failure and a shutdown of the plant. A longer restart procedure is then necessary to return to power operation which may be not compatible with the safety of the external grid.

The adjustment of the plant electrical output power must therefore be carried out within a few seconds following the loss of the network, which is incompatible with an action from the gas inventory system (this can be done easier for a water-steam PCS by reduction in water flow). The big decrease of electrical production is thus first achieved by opening the by-pass 1, which severely degrades the efficiency of the cycle (anyway this house load state is only lasting few hours). At the same time, the neutron power is also reduced (at  $\sim 80\%$  P<sub>nom</sub> power) with an automatic decrease of reactor power (identical to that used for the water-steam PCS).

In the very short term, the disconnection of the external grid induces an initial overspeed of the turbomachine which must be limited by acting on the bypass turbine valve. The simulations validate the principle of regulation (FIG. 8):

- the initial overspeed may be limited to about +4% considering a rapid opening of the turbine bypass valve which allows a 90% bypass of the nominal flow rate in about 1 s,
- opening of the turbine bypass allows a rapid reduction of the generated electrical power which falls to  $\sim 20\%$  of the nominal output electric power in a few seconds. Its stabilization at 7% is achieved by means of the bypass 1 which reaches its maximum opening after 100 s to allow approximately 40% of the nominal flow to pass through.

The feasibility of valves to achieve the above required level of performance is under study.

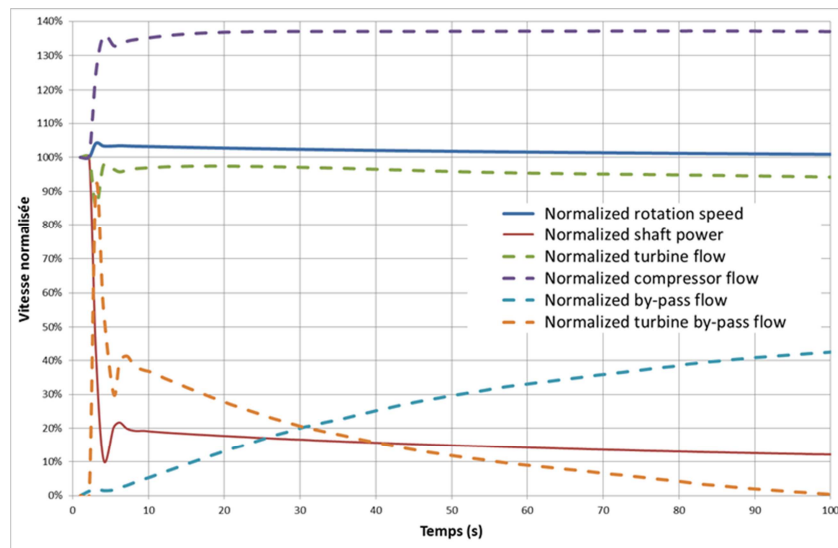

FIG 8: Shaft speed and gas flowrate (normalized by its nominal value) during a house load procedure.

In the longer term, the neutron power is gradually reduced to  $\sim 50\%$  Pnom. as well as the gas inventory, which makes it possible to optimize the operating point by limiting the amplitude of the bypass flows.

During these different phases, the regulation allows to maintain the temperature at the output of the ECSG at its nominal value (FIG. 9).

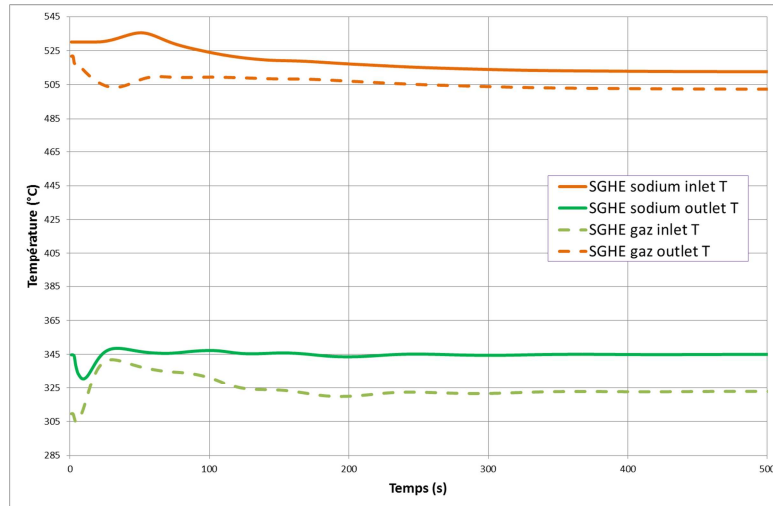

FIG. 9: Evolution of inlet and outlet temperature of the ECSG during a house load operation.

### 8.1. Grid frequency following:

Within the framework of the French legislation, and because of its importance for the network safety, it is required (for production facilities with a power of more than 40MWe) to participate in the primary and secondary frequency settings. This leads to having the capacity to keep a reserve of electrical power to be provided to the grid on demand coming from the French network management company (RTE). The envelope scenario for the reserve design is the cumulative request for primary and secondary frequency control which corresponds to a power call of + 7% with a ramp of 5% Pnom/min. for a minimum of 1/4h duration permanent level. For the water-steam PCS, this requirement is satisfied with a specific regulation on core power and on the secondary loop [5].

For the gas PCS the inertia of the tertiary circuit could not allow this regulation, therefore a very innovative regulation scheme has been developed. This regulation scheme is unfortunately still under a pending patent process but will be presented in details during the oral presentation at the conference.

### 8.2. Conclusions

Since the beginning of the ASTRID pre-conceptual phase, significant studies on technology and dynamic simulation of a gas PCS for ASTRID project have been performed in order to achieve (at the end of 2017) to a maturity as close as possible to one of the water-steam PCS. The following operating sequences and dedicated regulation have been calculated with CATHARE code and presented in this paper: start-up, normal shutdown, SCRAM and rapid shutdowns, gas inventory control, house load, grid frequency control. Any of these sequences have encountered unfeasibility or critical issue for the deployment of such gas cycle for a SFR

which has the big advantage to not address anymore the problematic sodium-water reaction risk.

Until the end of 2017 (when decision of retaining the cycle option) the program includes finalization of OC2 (operation category 2) to OC4 transients: long term loss of grid, loss of cold source, gas pipe breaks, changes of Na flowrate in a single secondary loop, changes of N2 flowrate for several events in the tertiary circuit, feasibility of using the gas cycle for long term residual power and impact on the primary convection startup, spurious triggering of by-passes...

Despite the gas cycle is innovative we must anticipate the potential risk of technology and operations failure for such cycle in order to evaluate the impact on the number of incidental events that would lead to a shutdown. Indeed, this is of importance for the lifetime that will be permitted for ASTRID and due to the steam-water cycle feedback experience on SFR operations, a lot of such events come from the tertiary circuit, therefore the reliability of this new Brayton gas cycle must be at least at the same level that the Rankine cycle reliability.

#### REFERENCES

- [1] F. GAUCHE; “The French Prototype of 4th Generation Reactor: ASTRID”; *Annual meeting on nuclear technology, Berlin, May 17&18th, (2011).*
- [2] J. ROUAULT *et al.*; “ASTRID, The SFR GEN IV Technology Demonstrator Project: Where are we, where do we stand for?” *Proceedings of ICAPP’15, Nice, France, May 03-06, (2015)*
- [3] D. PLANCQ *et al.*, “Status of studies on ASTRID gas power conversion system option”; *Proceedings of ICAPP’16, San Francisco United-States, April 17-20, (2016)*
- [4] D. PLANCQ *et al.*, “Progress in the ASTRID Gas Power Conversion System development”; *Proceedings of FR17, Ykaterinburg, June 26-29, (2017)*
- [5] D. BARBIER *et al.* , “ASTRID: operation procedures to comply with grid regulation and a plant lifetime up to 60 years”; *Proceedings of ICAPP’16, San Francisco United-States, April 17-20, (2016)*