



HAL
open science

Overview of Post-Irradiation Examination results on Minor Actinide bearing fuels within the FUTURIX-FTA international collaboration

D. Freis, F. Delage, G. Cecilia, J. Lamontagne, L. Loubet, C. Sabathier, R. Nasyrow, D. Papaioannou, G. Paperini, W de Weerd, et al.

► To cite this version:

D. Freis, F. Delage, G. Cecilia, J. Lamontagne, L. Loubet, et al.. Overview of Post-Irradiation Examination results on Minor Actinide bearing fuels within the FUTURIX-FTA international collaboration. 14th International Exchange Meeting on Partitioning and Transmutation, Oct 2016, San Diego, United States. cea-02435065

HAL Id: cea-02435065

<https://cea.hal.science/cea-02435065>

Submitted on 19 Mar 2020

HAL is a multi-disciplinary open access archive for the deposit and dissemination of scientific research documents, whether they are published or not. The documents may come from teaching and research institutions in France or abroad, or from public or private research centers.

L'archive ouverte pluridisciplinaire **HAL**, est destinée au dépôt et à la diffusion de documents scientifiques de niveau recherche, publiés ou non, émanant des établissements d'enseignement et de recherche français ou étrangers, des laboratoires publics ou privés.



14th International Exchange Meeting on Partitioning & Transmutation

Overview of Post-Irradiation Examination results on Minor Actinide bearing fuels within the FUTURIX-FTA international collaboration

D. Freis, F. Delage**, G. Cécilia**, J. Lamontagne**, L. Loubet**, C. Sabathier**, R. Nasyrow*, D. Papaioannou*, G. Paperini*, W. de Weerd*, J. Somers*, R. Konings**

**European Commission, JRC, Directorate G - Nuclear Safety and Security*

***CEA/DEN/DEC, Cadarache Centre, Fuel Study Department, France*



European
Commission

Overview

1. The Joint Research Centre – Directorate G
2. The FUTURIX-FTA Irradiation Experiment
3. Fuel Preparation (FX 5 & 6) / Fuel Characteristics
4. Irradiation Conditions
5. Post Irradiation Examination of CerCer & CerMet Fuels
6. Summary

The Joint Research Centre (JRC)

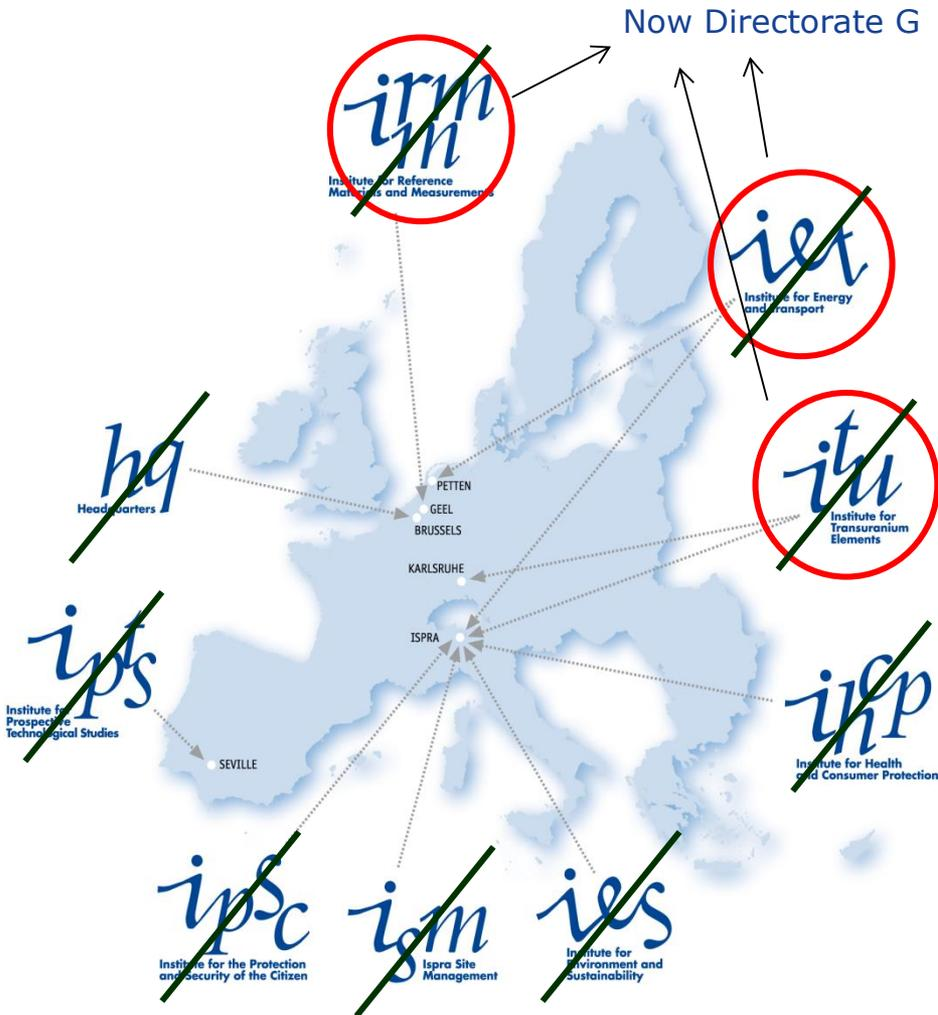

The JRC is the European Commission's science and knowledge service.

JRC has **10 Directorates**, is located across 5 EU Member States and employs over **3000 people**.

JRC's nuclear work programme, funded by **EURATOM** is carried out by **Directorate G – Nuclear Safety and Security**, which employs more than **500 people** at sites in Karlsruhe (former ITU), Petten, Geel and Ispra (red circles).

Directorate G contributes to the scientific foundation for the **protection of the European citizen against risks** associated with the handling and storage of **highly radioactive material**.

The FUTURIX-FTA Irradiation Experiment

- **Title:** FUels for Transmutation of transURanium elements in phenIX / Fortes Teneurs en Actinides [high actinide content]
- **Objectives:** Comparison of irradiation behavior of oxides, nitrides & metallic MA-bearing fuels (U-free fuels for ADS and metallic low fertile fuels for SFR burner) in representative conditions -> 8 pins irradiated in PHÉNIX
- **Participants:** CEA, DOE, JAEA & JRC-Karlsruhe through bilateral agreements, FP-6 EUROTRANS (2005-2010) & FP-7 FAIRFUELS (2009-2015)
- **Key dates:**
 - Experimental grid: 2003
 - Transportations of fresh fuels from JRC-Karlsruhe and INL to ATALANTE facility: 2006
 - Irradiation in PHÉNIX: May 2007 till March 2009 for 235 EFPD (except nitrides)
 - Pins transportations from PHÉNIX to Cadarache (June 2013), INL (summer 2014), JRC-Karlsruhe (February 2015)
 - PIE for JRC-Karlsruhe & CEA pins firstly in FP-7 FAIRFUELS and in national programs since mid. 2015

FUTURIX-FTA Fuels

Pin	Fuel type	Composition ^[1]	Am content
DOE 1	Metal / low-fertile	35U-29Pu-4Am-2Np-30Zr (wt %)	0.5 g/cm ³
DOE 2	Metal / U-free	U 48Pu-12Am-40Zr (wt %)	1.2 g/cm ³
DOE 3	Nitride / low-fertile	(U _{0.5} ,Pu _{0.25} ,Am _{0.15} ,Np _{0.10})N	1.7 g/cm ³
DOE 4	Nitride / U-free	(Pu _{0.21} ,Am _{0.21} ,Zr _{0.58})N	2.7 g/cm ³
ITU 5	Cer-Met / U-free	(Pu_{0.8},Am_{0.2})O₂ + 86 vol% Mo	0.3 g/cm³
ITU 6	Cer-Met / U-free	(Pu_{0.23},Am_{0.25},Zr_{0.52})O₂ + 60 vol% Mo	1.0 g/cm³
CEA 7	Cer-Cer / U-free	(Pu _{0.5} ,Am _{0.5})O ₂ + 80 vol% MgO	1.0 g/cm ³
CEA 8	Cer-Cer / U-free	(Pu _{0.2} ,Am _{0.8})O ₂ + 75 vol% MgO	2.0 g/cm ³

PIE on CEA 7 & 8 was already presented at Global 2015^[2]. PIE results on pins ITU 5 & 6 are newly presented^[3].

Fuel Preparation – FX 5 & 6

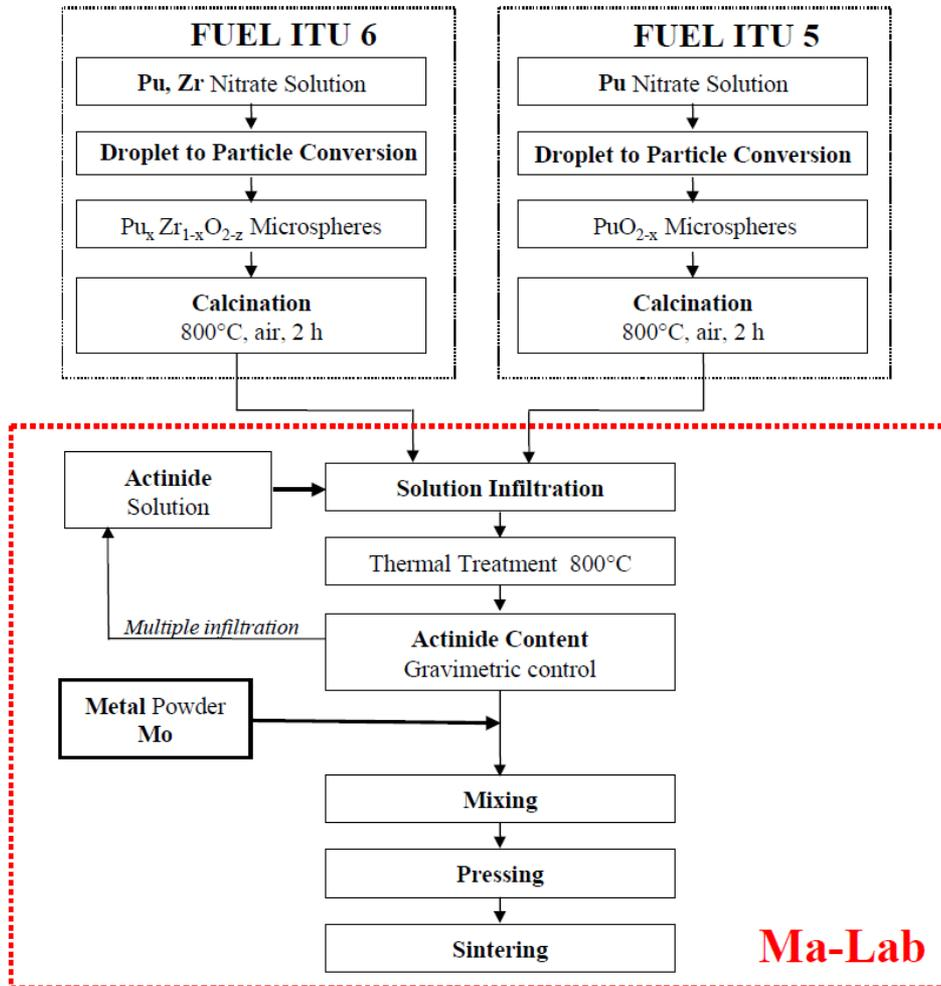

- Particle synthesis by external gelation
- Infiltration of Am into porous $(\text{Pu,Zr})\text{O}_{2-x}$ & PuO_{2-x} particles
- Mixing of fuel particles and Molybdenum matrix by conventional powder blending
- Bi-axial pressing (500 MPa)
- Sintering (1600°C, 8h)

Visual Aspect of ITU 5 & 6

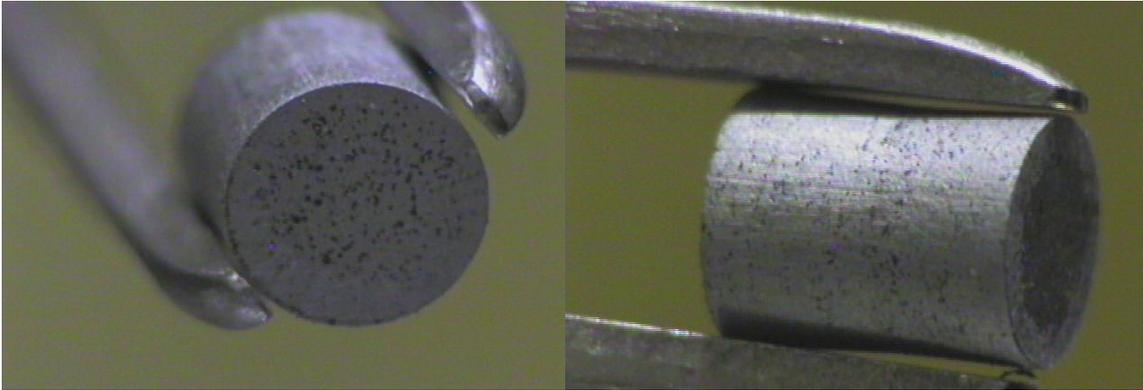

ITU 5
86% Mo

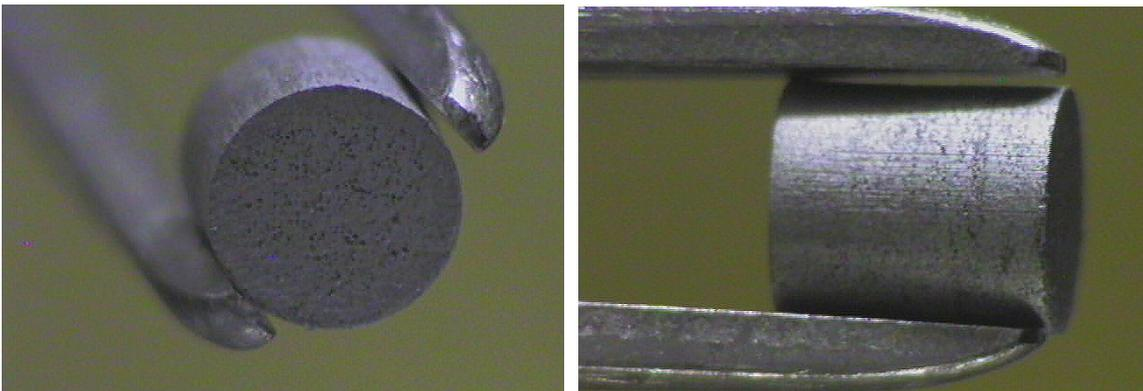

ITU 6
60% Mo

Ceramographs



ITU 5
86% Mo

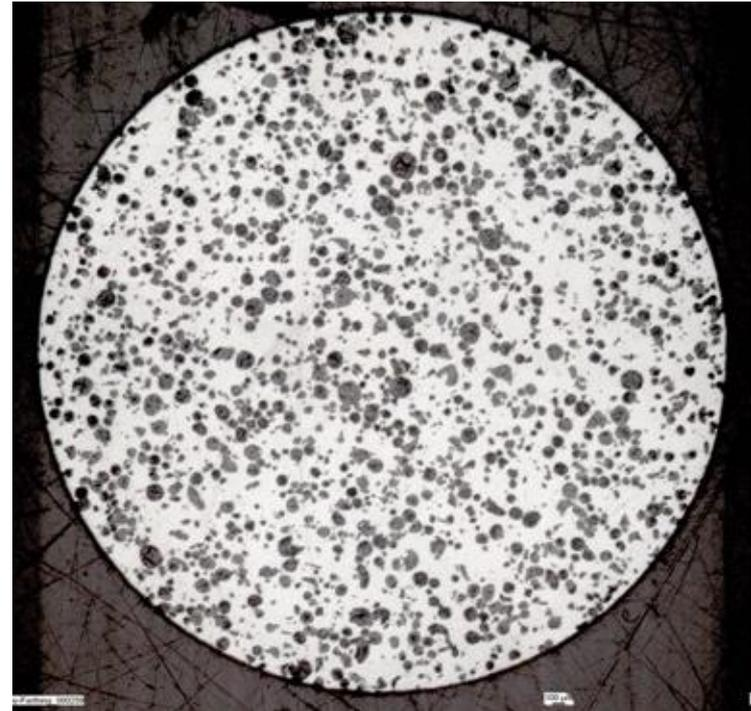

ITU 6
60% Mo

Fuel Preparation – FX 7 & 8

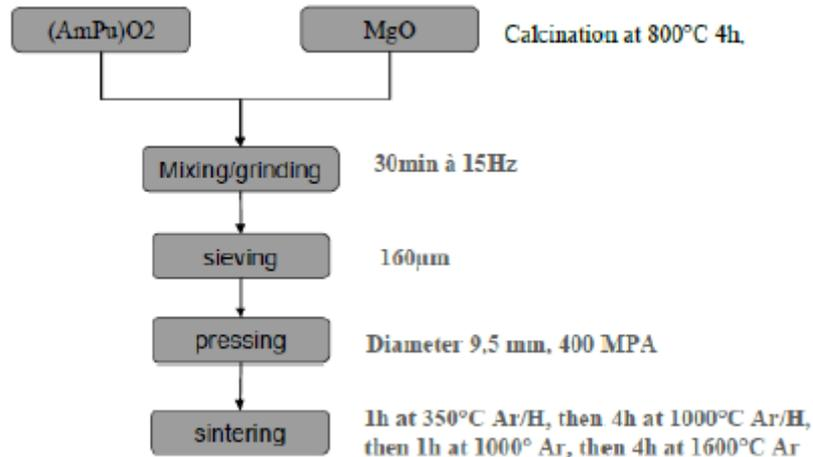

- Preparation in shielded cells (ATALANTE facility)
- Synthesis of $(Pu,Am)O_{2-x}$ particles by oxalic co-conversion
- Particles dispersion into inert magnesia matrix by conventional powder metallurgy process
- Sintering

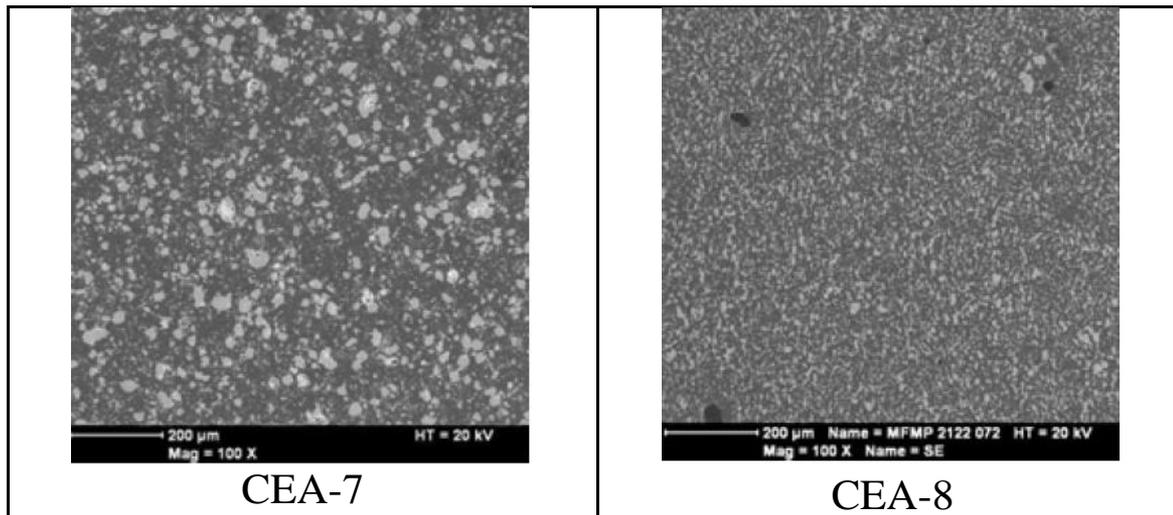

Fuel Characteristics

Fuel ID	ITU-5	ITU-6	CEA 7	CEA 8
Pu content (wt%)	10.17	9.40	19.9	9.1
Am content (wt%)	2.68	10.33	19.6	35.6
Mean diameter (mm)	5.18	5.19	5.19	~5.14
Average Height (mm)	6.00	5.80	6.66	6.49
Density (g.cm⁻³)	10.37	9.50	4.88	5.12
Total porosity (%)	4.1	4.8	4.5	7.5
Open porosity (%)	0.5-0.6	0.7-0.8	0.3*	0.4*
O/M (particle)	1.896	1.786	1.88	1.73
Particle size (µm)	< 225	< 225	< 50	< 50
Particle fraction	14 (volume %)	40 (volume %)	20 (volume %)	25 (volume %)

*estimated

FUTURIX CerMet & CerCer Fuel Pins

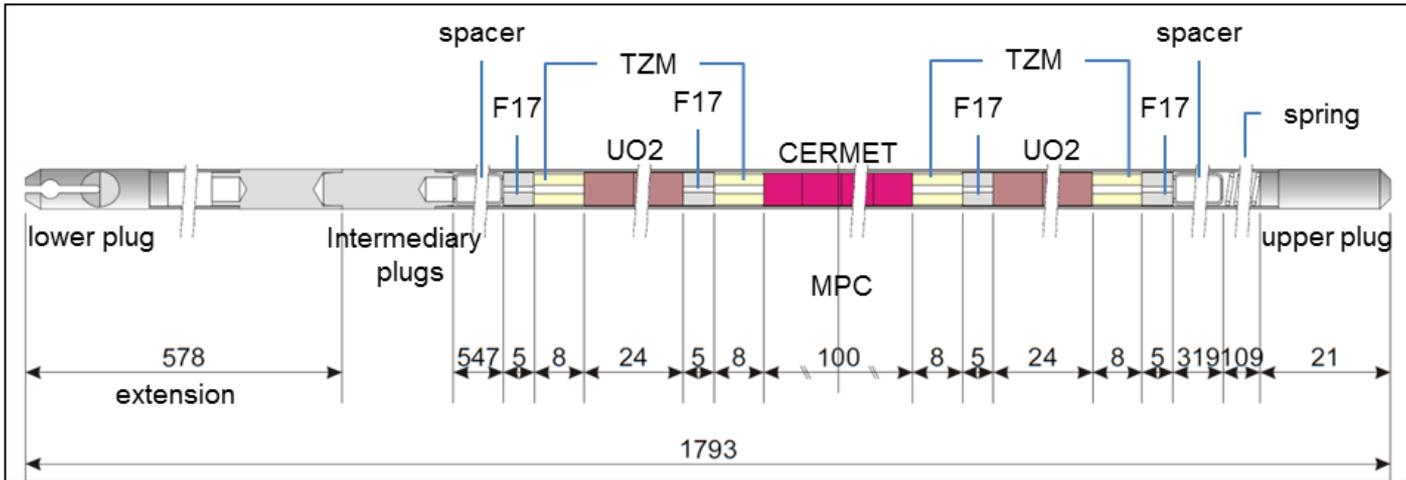

CerMet
ITU 5&6

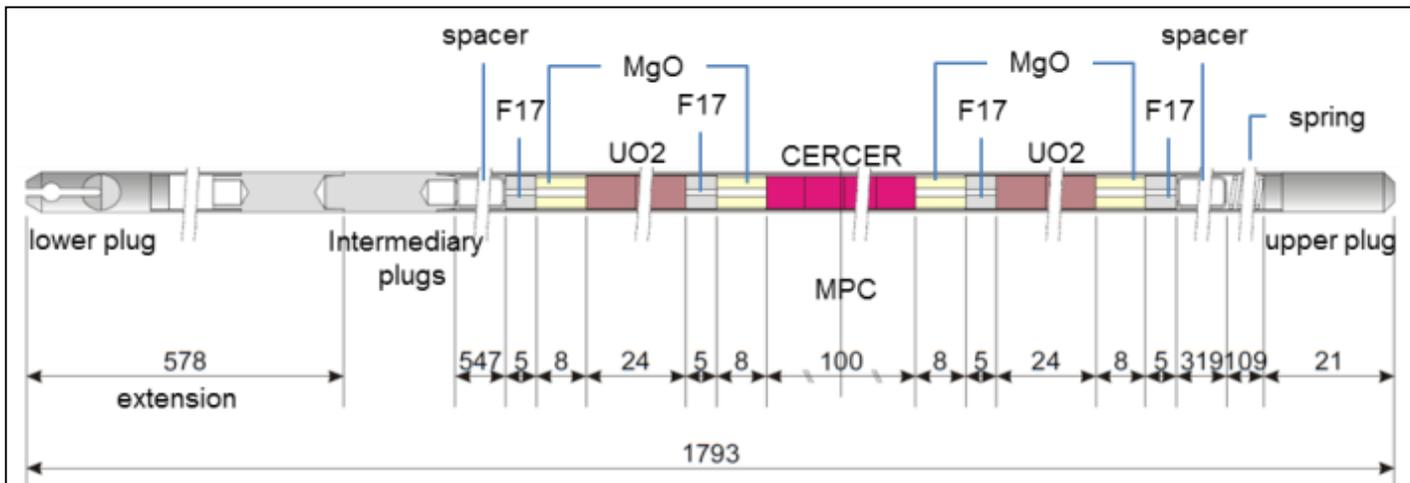

CerCer
CEA 7&8

FUTURIX-FTA Position in Phénix Core

CERCER (CEA 7&8)

- Cumulated fluence: $0.93 \times 10^{23} \text{ n.cm}^{-2}$
- Fluence $>0.1 \text{ MeV}$: $0.55 \times 10^{23} \text{ n.cm}^{-2}$
- Max. dose: 28.7 dpa
- Max. temperature*: 1430°C (CEA 7) & 1270°C (CEA 8)

CERMET (ITU 5&6)

- Cumulated fluence: $1.46 \times 10^{23} \text{ n.cm}^{-2}$
- Fluence $>0.1 \text{ MeV}$: $0.88 \times 10^{23} \text{ n.cm}^{-2}$
- Max. dose: 38.6 dpa
- Max. temperature*: 1580°C (ITU 5) & 1480°C (ITU 6)

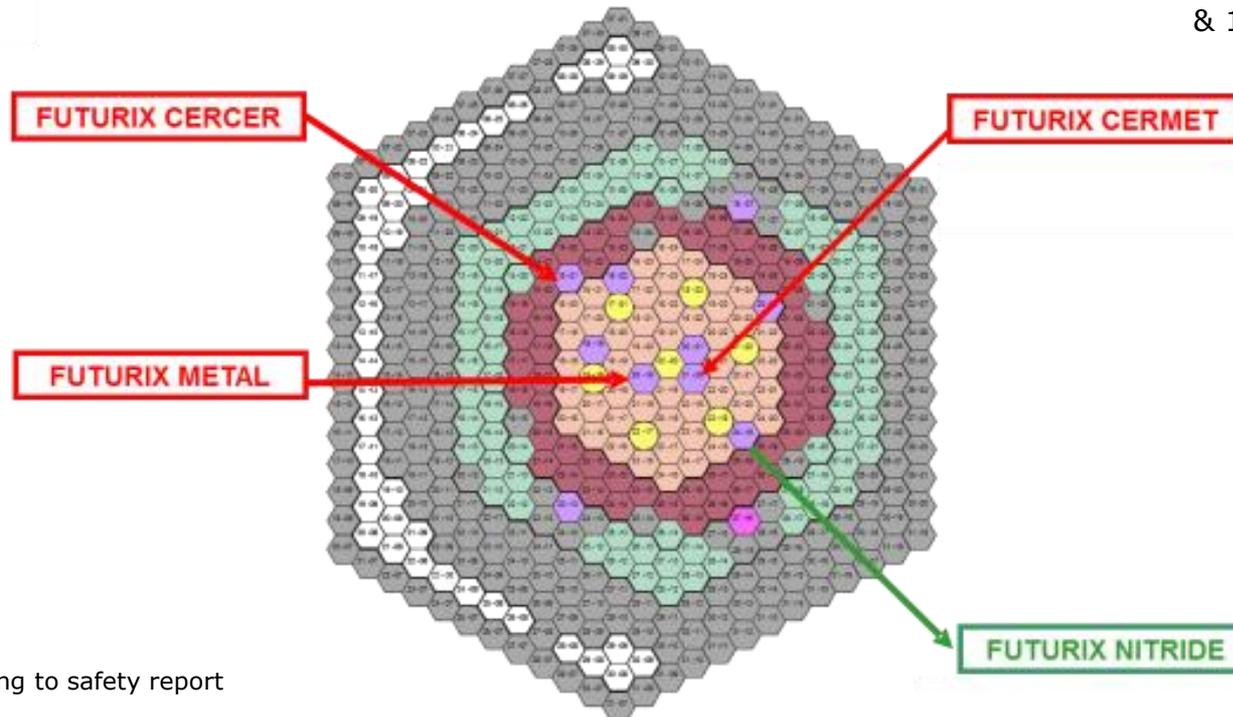

*according to safety report

FUTURIX-FTA Irradiation Conditions

Pin	Burn-up (at%)	Transmutation rate (at%)	Linear Heat Rate (W/cm)	Neutron fluence	Dose (dpa)
ITU 5	17.81	27.0	122 - 133	14.59 x 10^{26} n/m ²	38.58
ITU 6	12.88	27.1	124 - 135		
CEA 7	8.6	17.6	82 - 96	9.33 x 10^{26} n/m ²	28.69
CEA 8	5.75	19.8	82 - 87		

Power Evolution ITU 5 & 6

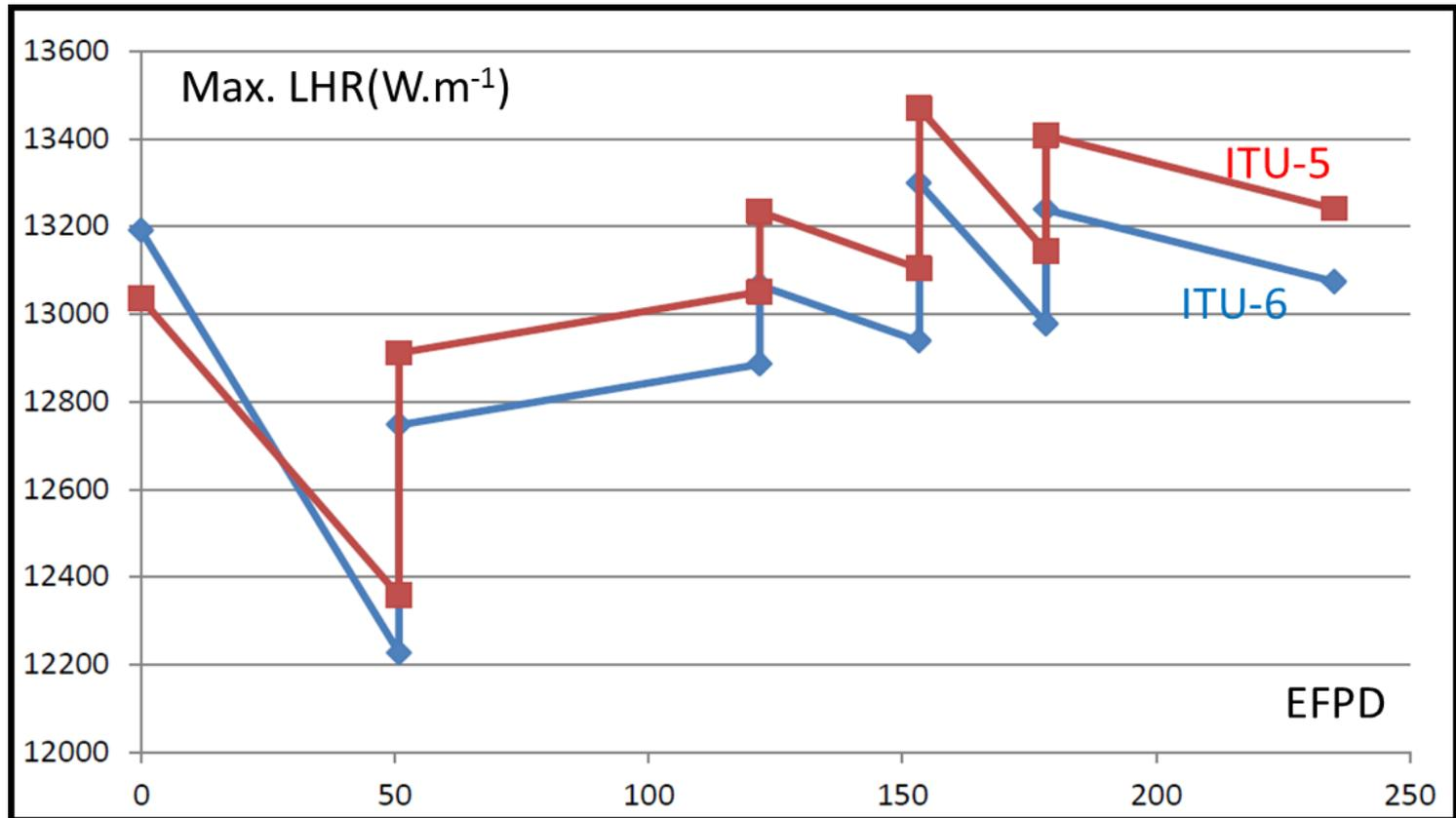

Power Evolution CEA 7 & 8

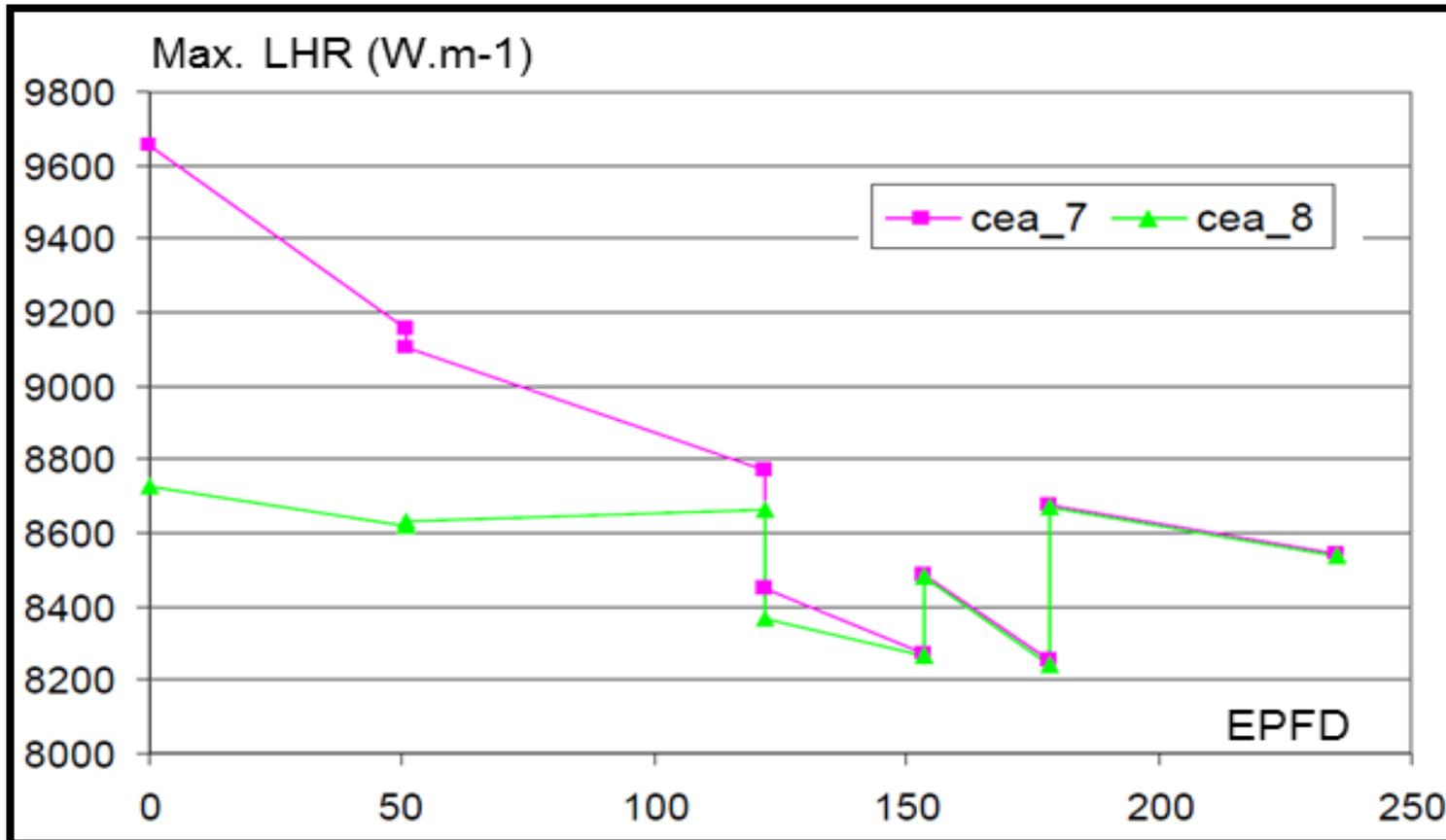

Post Irradiation Examinations

- CerMet Fuel (ITU 5 & 6): JRC-ITU hot cells
 - **Pin length & profilometry** ✓
 - **Gamma spectrometry** ✓
 - **Gas puncturing** ✓
 - **Ceramography** ✓
 - **Pellet Metrology and Hydrostatic Density (ongoing)**
 - **SEM, EPMA (to be done)**
 - **LaserFlash (to be done)**
- CerCer Fuel (CEA 7 & 8): LECA facility (CEA-Cadarache)
 - **Pin length & profilometry** ✓
 - **Gamma spectrometry** ✓
 - **Gas puncturing** ✓
 - **Pellet Metrology and Hydrostatic Density** ✓
 - **Ceramography** ✓
 - **SEM, EPMA (to be done)**

Pin Length Measurement & Profilometry showing no significant changes

FUTURIX-FTA Pins:	ITU-5	ITU-6	CEA-7	CEA-8
Length before irradiation (mm):	1793	1793	1793	1793
Length after irradiation (mm):	1793.0	1793.1	1792.2	1792.0

FUTURIX-FTA Pins:	ITU-5	ITU-6	CEA-7	CEA-8
Maximum diameter at experimental column after irradiation (mm)	6.571	6.558	6.562	6.557
Change in % (relative to 6.55 mm)	0.3	0.1	0.2	0.1

Profilometry ITU-5

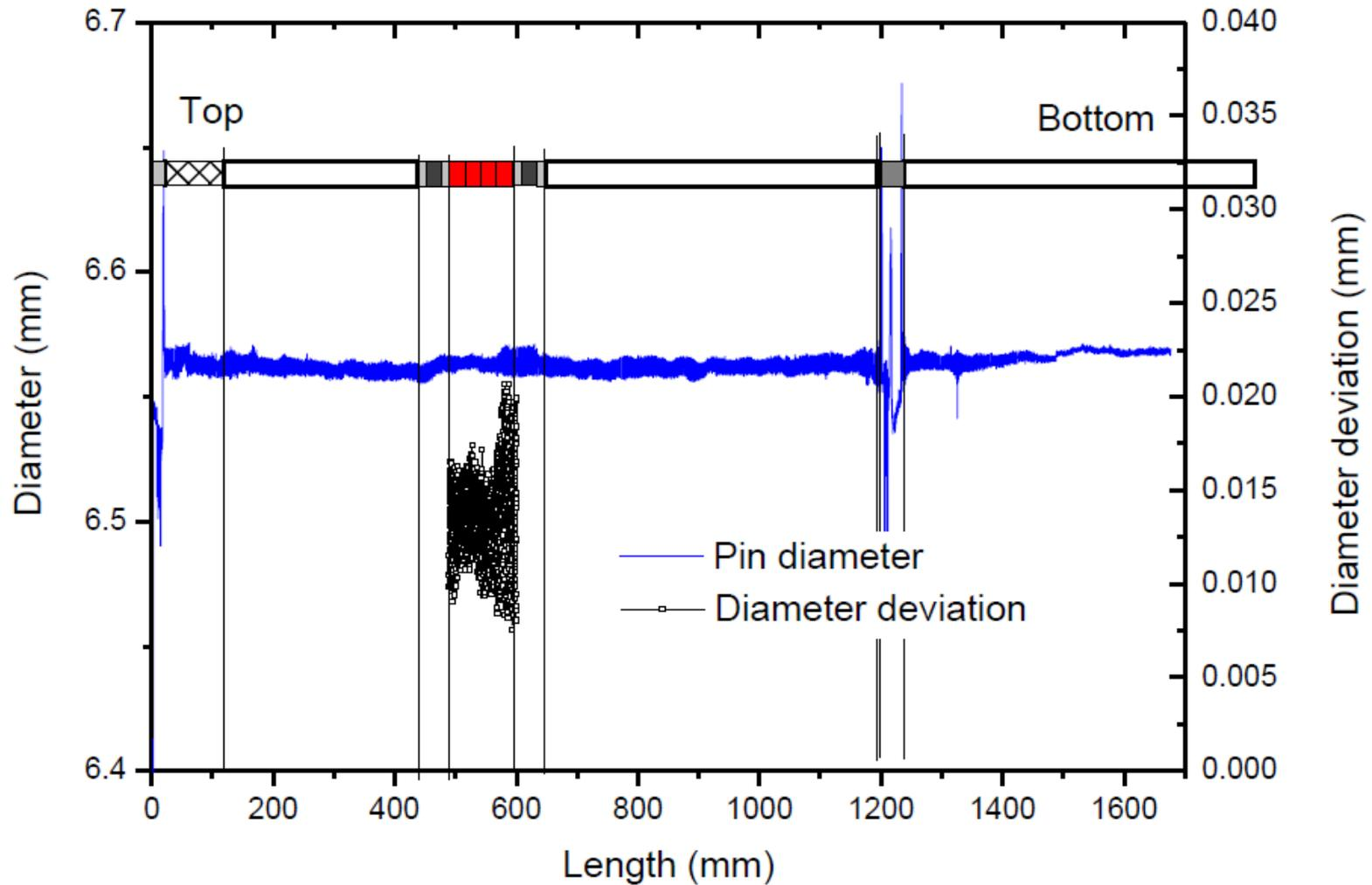

Gamma spectrometry

Gamma Spectrometry of ITU-5 (^{137}Cs)

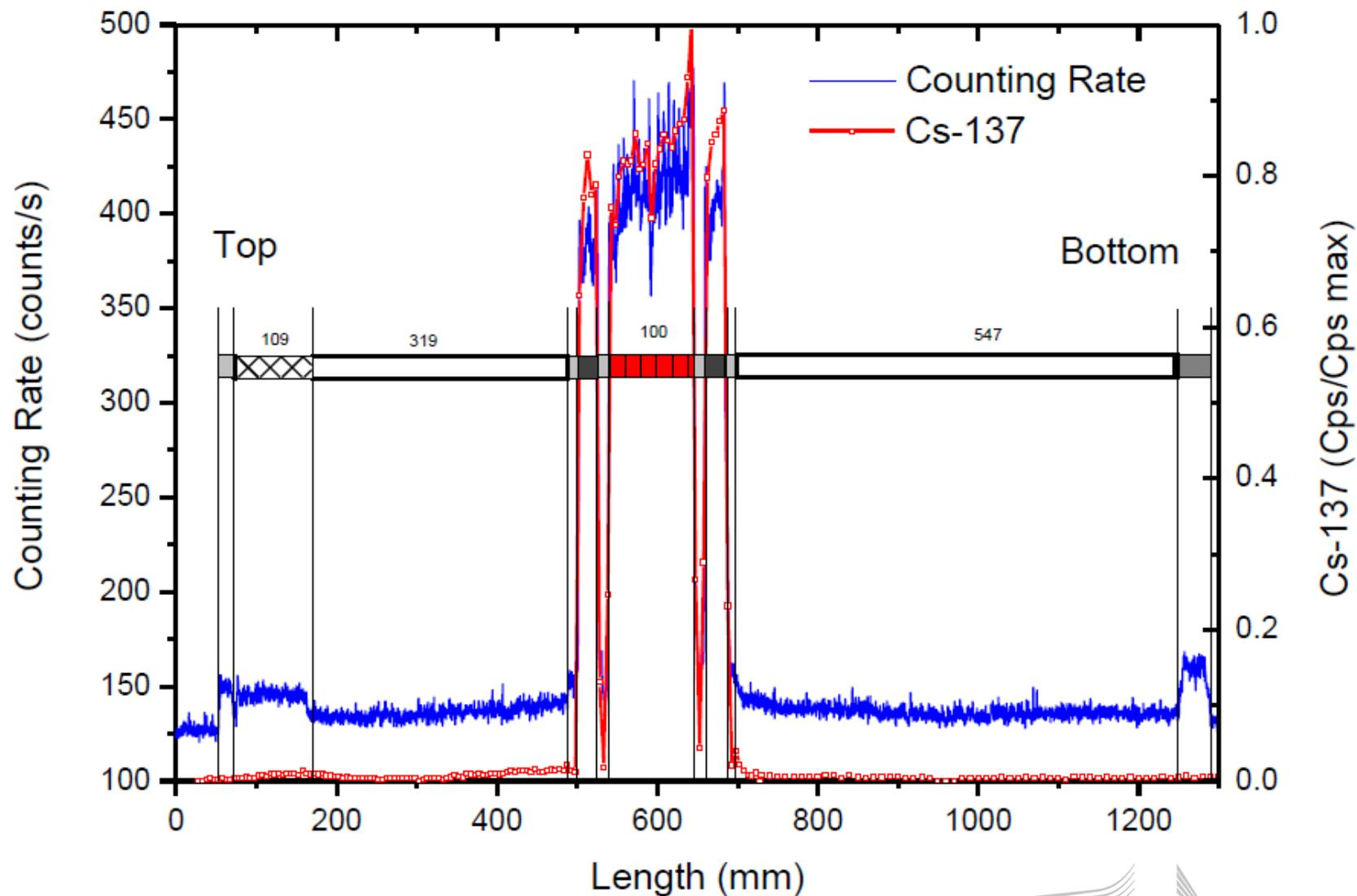

Gamma Spectrometry of ITU 5&6 (^{137}Cs)

Gamma scanning of pin 5
(total & Cs-137)

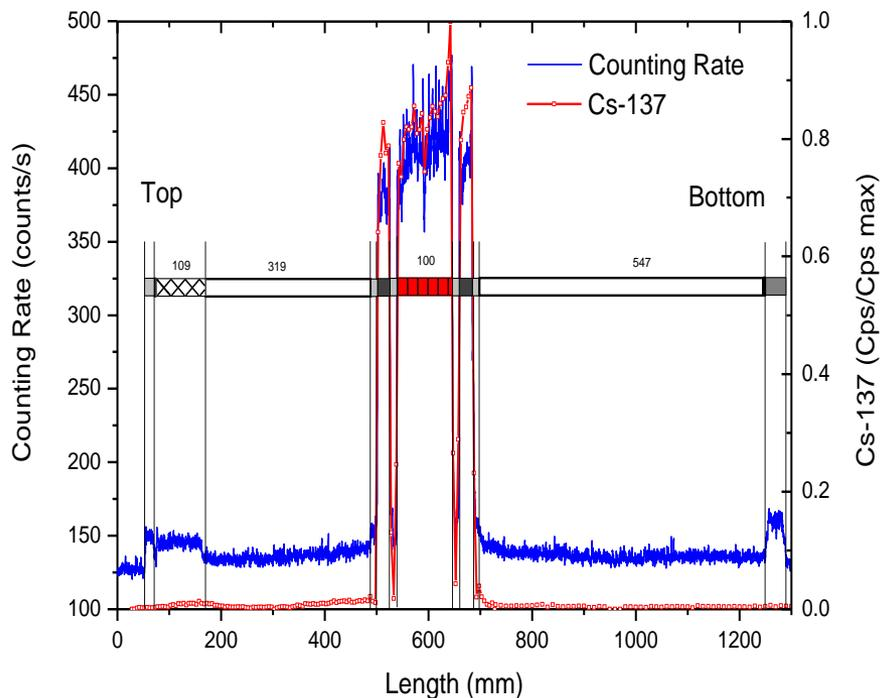

Gamma scanning of pin 6
(total & Cs-137)

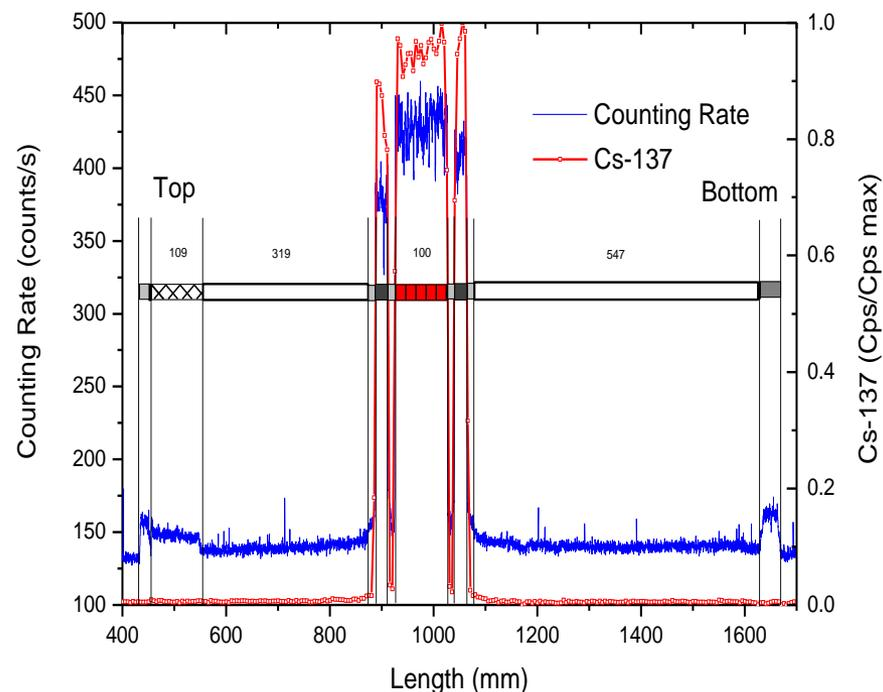

Gamma Spectrometry of ITU-5 (^{54}Mn)

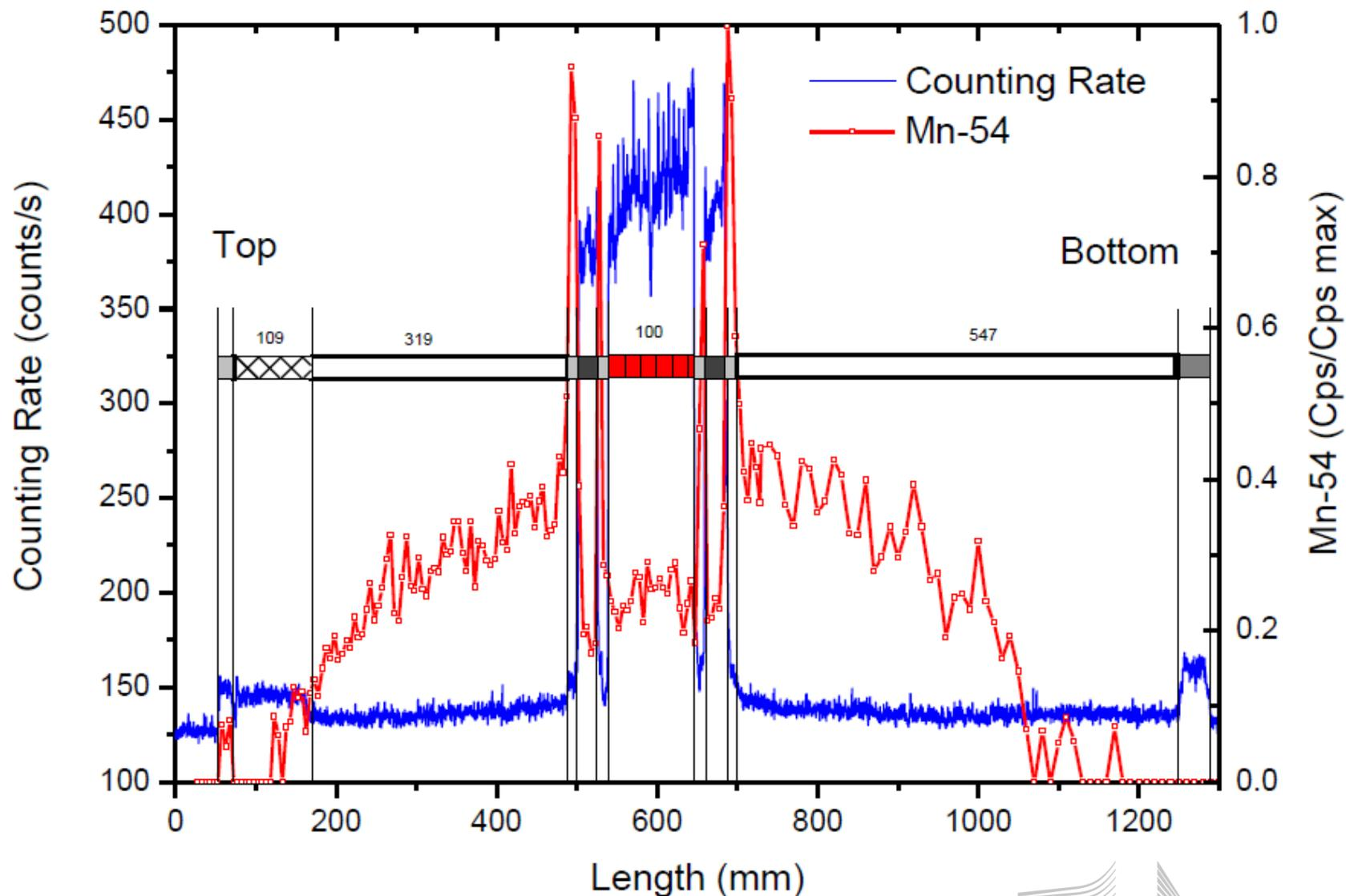

Gamma Spectrometry of ITU 5&6 (^{241}Am)

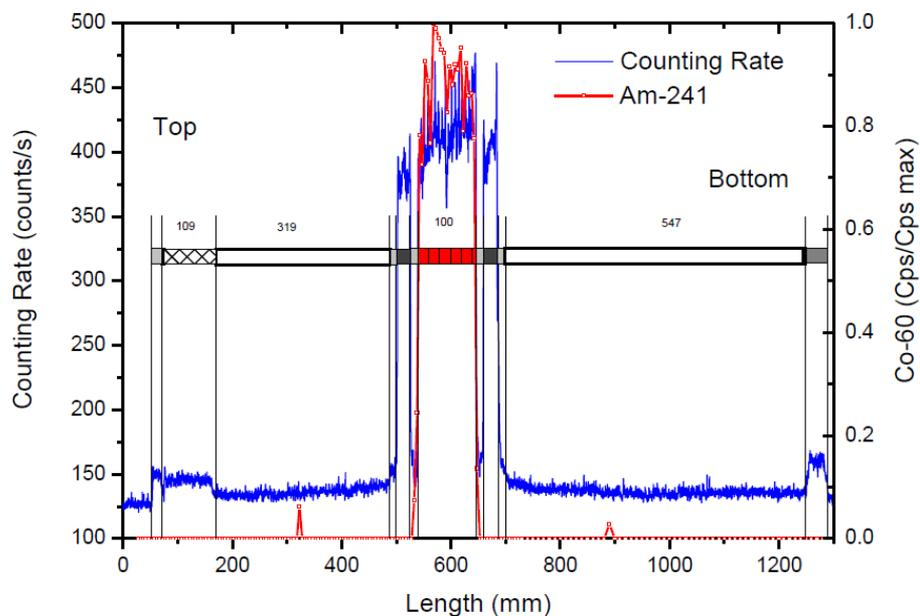

ITU-5

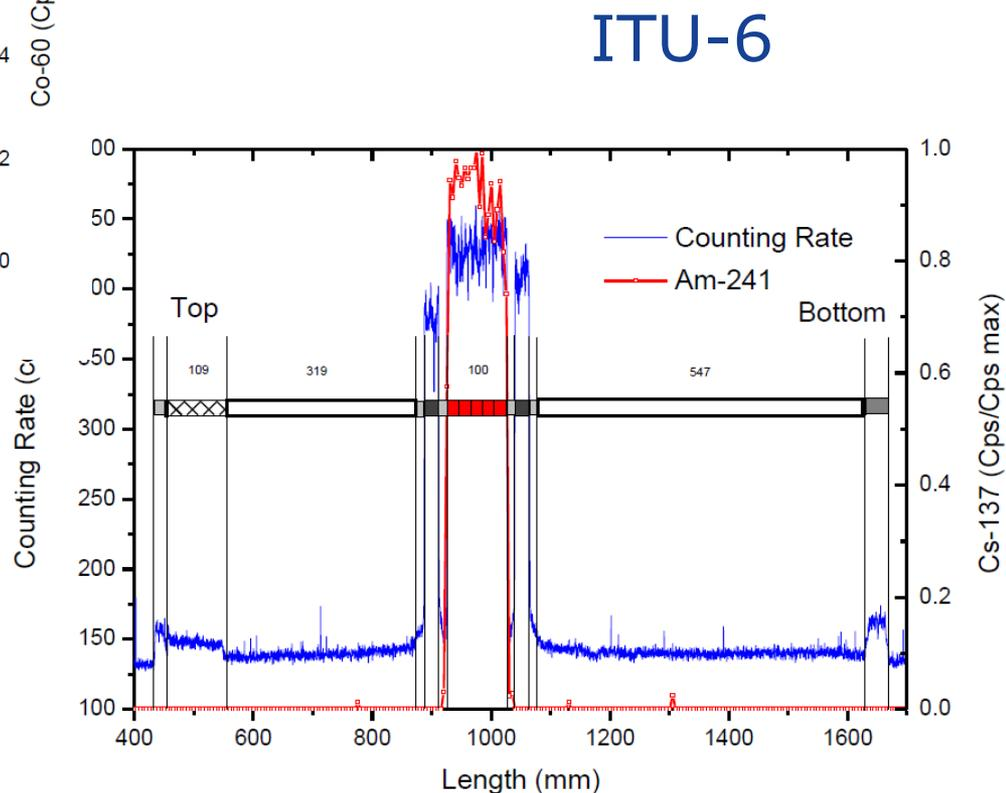

Gamma Spectrometry of CEA 7 (^{137}Cs (red), ^{54}Mn (green) and ^{60}Co (blue))

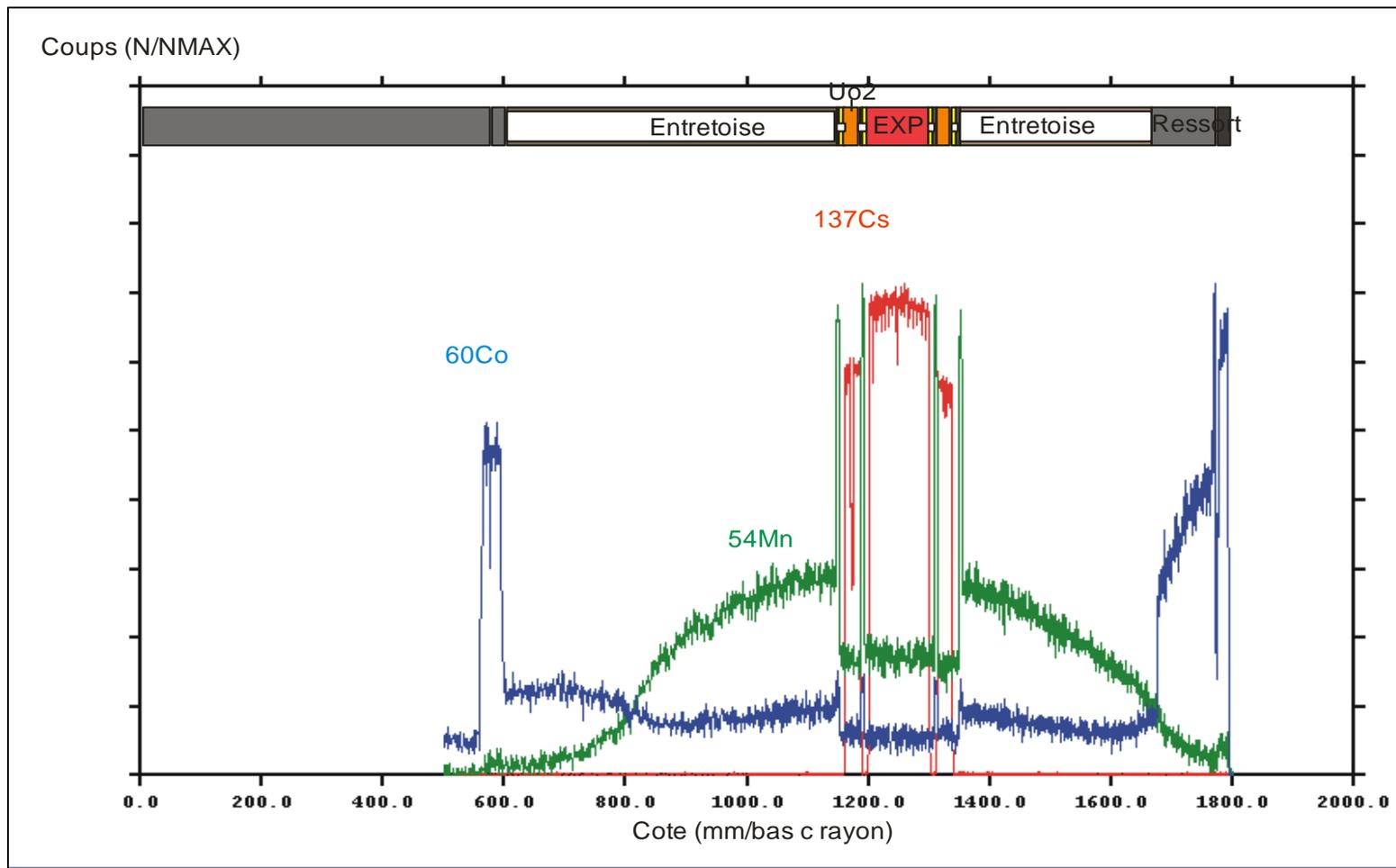

Gamma spectrometry of CEA 8 (^{137}Cs (red), ^{54}Mn (green) and ^{60}Co (blue))

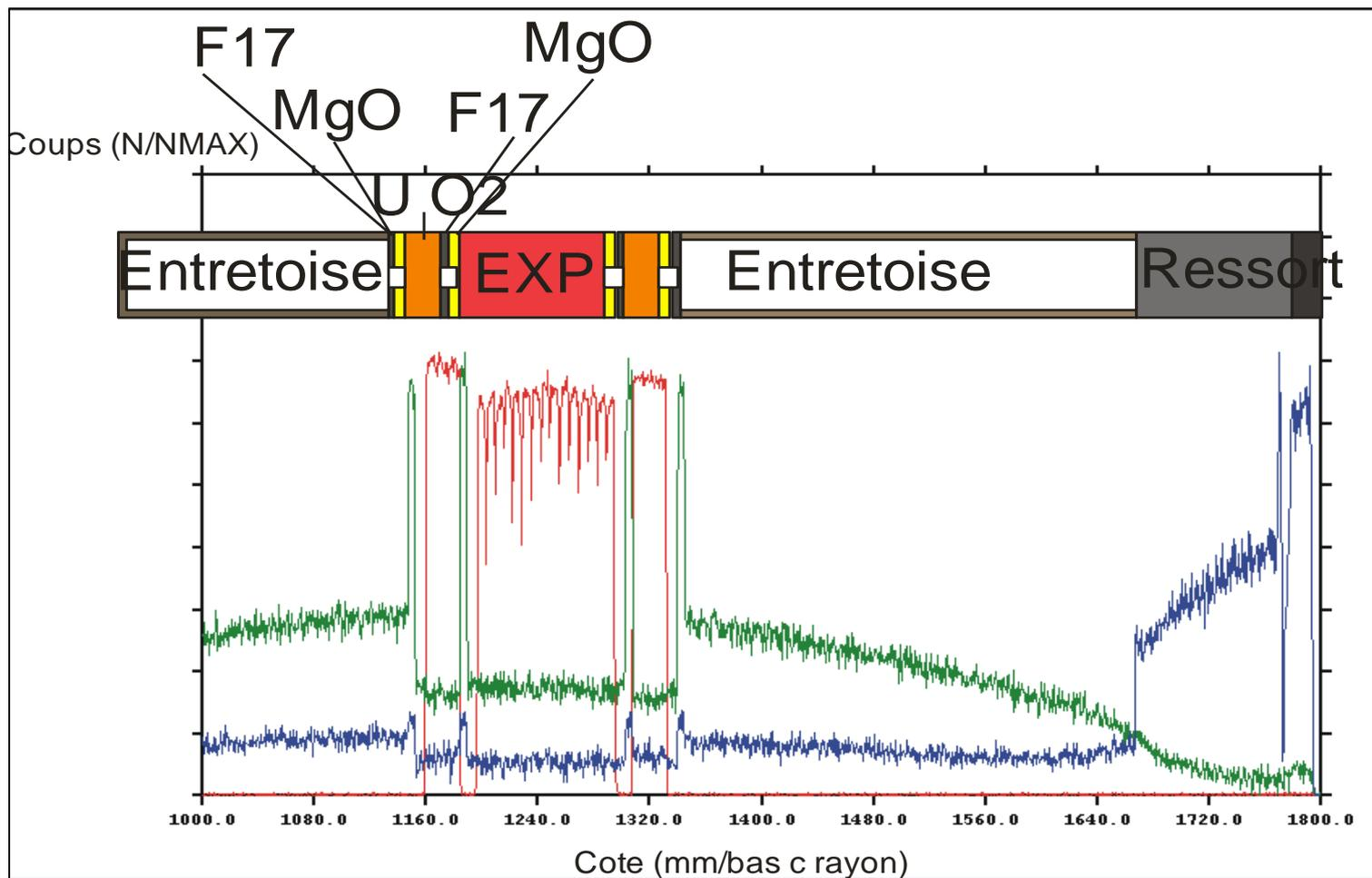

Comparison of the ^{137}Cs distribution between pins CEA 7 (blue) and CEA 8 (red)

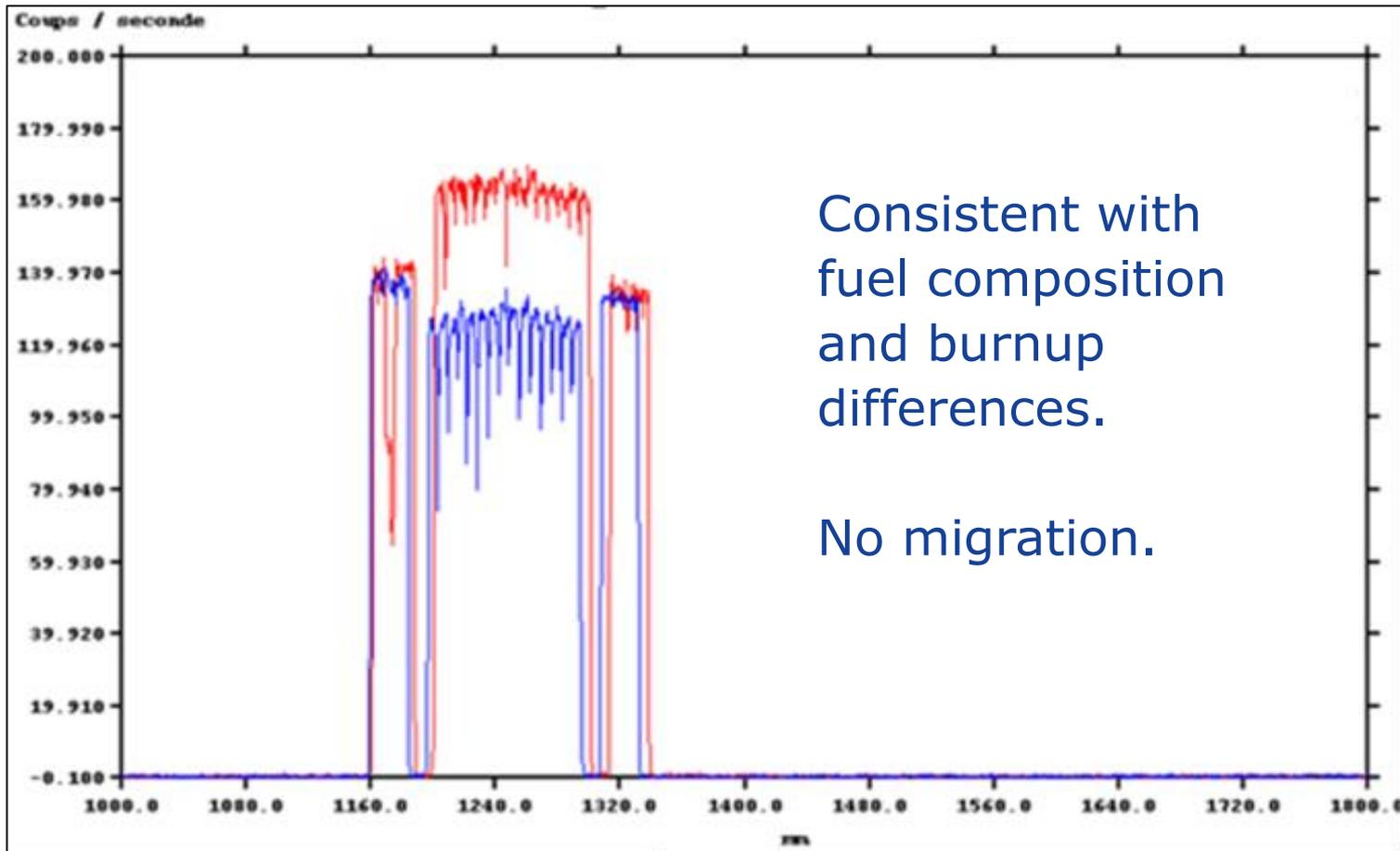

Determination of Pellet Positions ITU-5

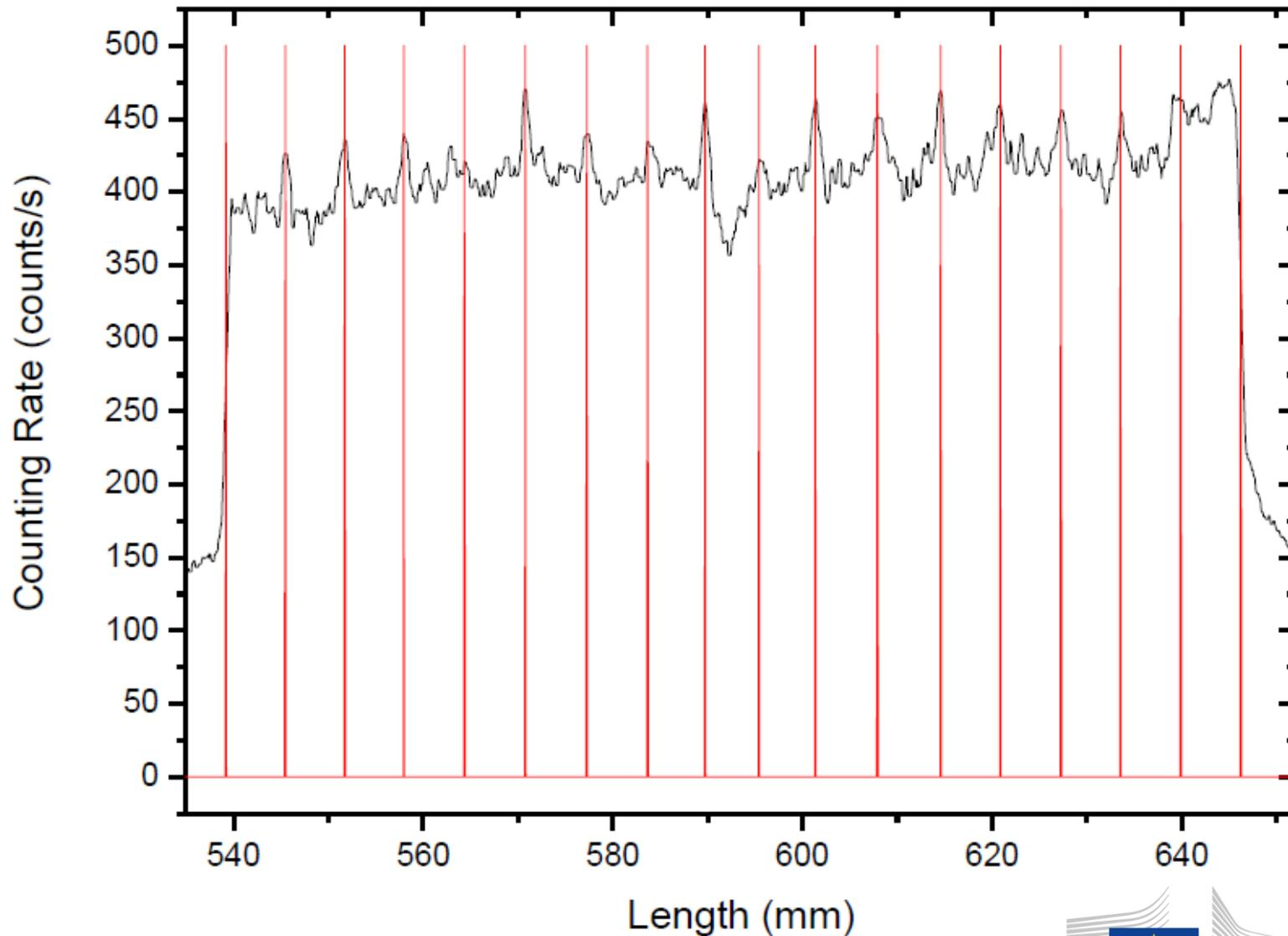

Estimation of Pellet Elongation from Gamma Spectrometry for ITU-5

Pellet No.	Measured length (mm)	Original length (mm)	Change (%)
1	6.28	6.15	2.05
2	6.28	5.89	6.55
3	6.21	6.04	2.80
4	6.41	6.07	5.59
5	6.41	6.16	4.05
6	6.48	6.04	7.22
7	6.41	6.14	4.39
8	6.08	5.7	6.59
9	5.67	5.5	3.18
10	5.94	5.62	5.73
11	6.54	6.2	5.53
12	6.68	6.24	6.99
13	6.28	6.04	3.91
14	6.41	6.17	3.88
15	6.28	6.01	4.42
16	6.34	6.04	5.01
17	6.34	6.06	4.66
Total column:	107.02	102.07	4.85

Estimation of Pellet Swelling from Gamma Spectrometry

Pin ID:	ITU 5	ITU 6	CEA 7	CEA 8
Fuel column length before irradiation (mm):	102.07	98.68	99.21	97.35
Fuel column length after irradiation (mm):	107.02	101.70	100.1	98.0
Relative elongation (%):	4.85	3.06	0.9	0.7
Equivalent to volume swelling of (%)*:	15.3	9.5	2.7	2.1

Results indicate that there might have been no gap closure (together with profilometry).

Gas Puncturing Results

Low Fractional Releases in Both Pins

		He(mol)	Kr(mol)	Xe(mol)	Total (mol)
ITU-5	produced	4.68×10^{-4}	7.00×10^{-5}	7.32×10^{-4}	1.27×10^{-3}
	FR (%)	43.23	33.40	22.44	31.06
ITU-6	produced	1.55×10^{-3}	6.95×10^{-5}	7.20×10^{-4}	2.34×10^{-3}
	FR (%)	35.87	43.17	21.67	30.10
CEA-7	produced	1.20×10^{-3}	4.93×10^{-5}	5.04×10^{-4}	1.75×10^{-3}
	FR (%)	~0	0.75		<1
CEA-8	produced	2.32×10^{-3}	4.42×10^{-5}	4.25×10^{-4}	2.79×10^{-3}
	FR (%)	~0	0.22		<1

Recovery of CerMet Pellets

- All pellets were found loose inside pin, no indication of gap closure
- All pellets were completely intact and could be extracted
- Confirmation of gamma spectrometry

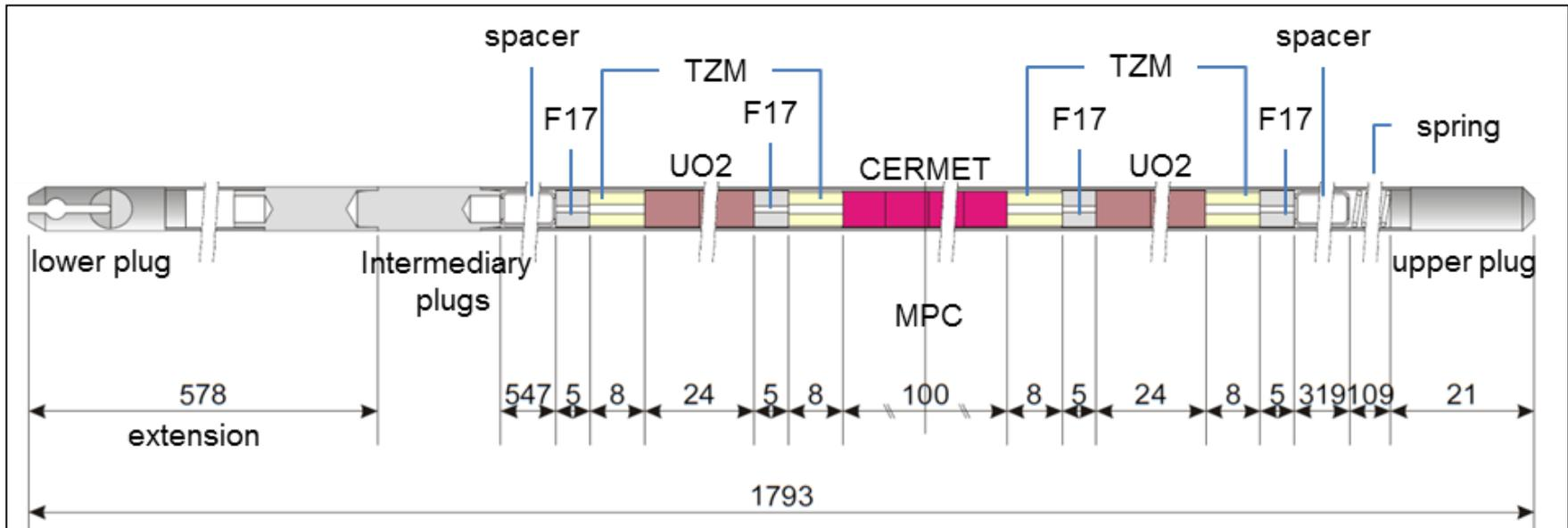

Ceramography of ITU 5 ($\text{Pu}_{0.8}\text{Am}_{0.2}\text{O}_{1.9}$ + 86 vol% Mo)

Fresh fuel

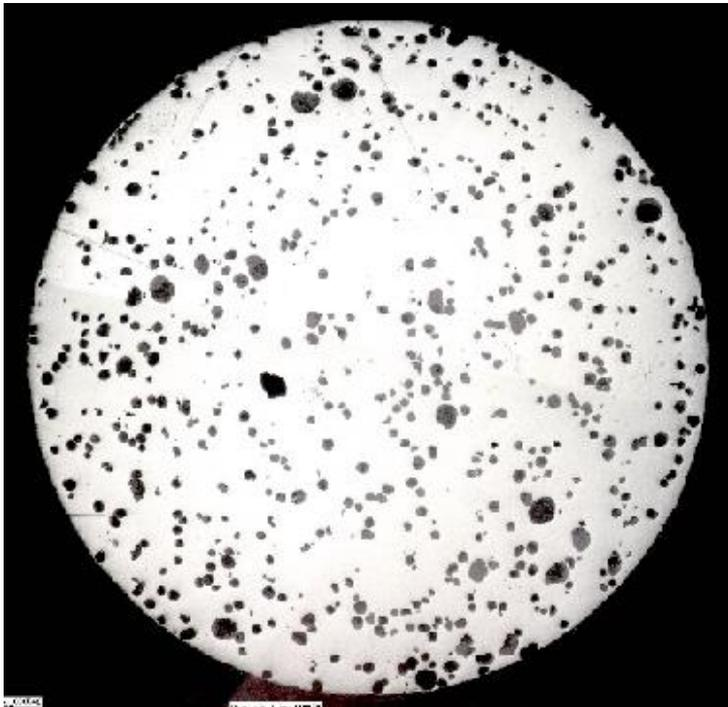

Irradiated fuel

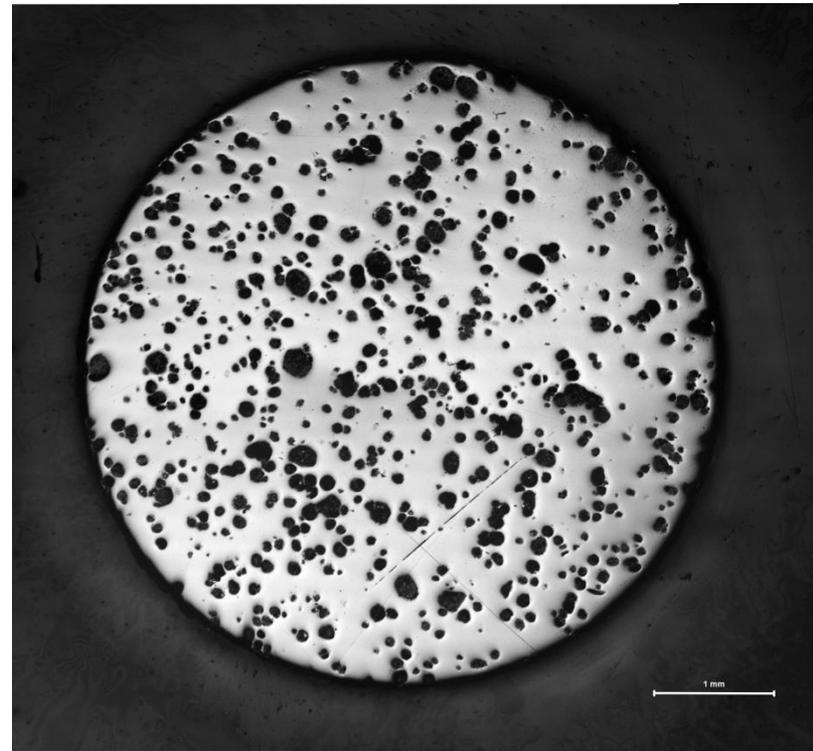

- No cracks in Mo matrix
- Particle at pellet boundary formed open porosity -> gas release

Ceramography of ITU 5 ($\text{Pu}_{0.8}\text{Am}_{0.2}\text{O}_{1.9}$ + 86 vol% Mo)

Fresh fuel

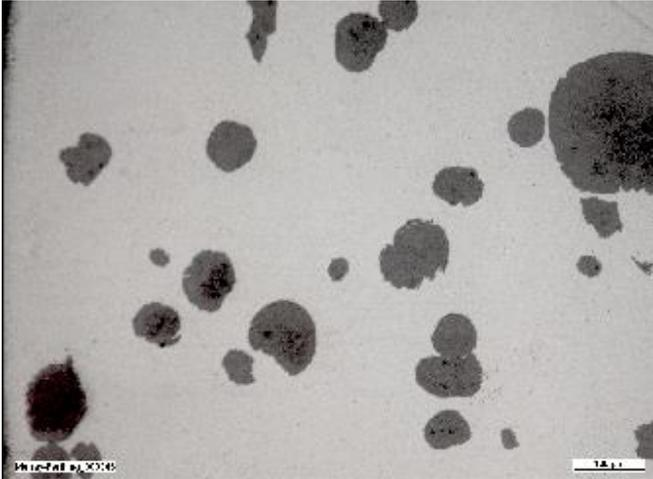

- No cracks in Mo matrix
- Metallic precipitates in particles
- Gas bubbles mainly located in particles
- "Finger"-like particle-matrix transition
- Halo around particles

Irradiated fuel

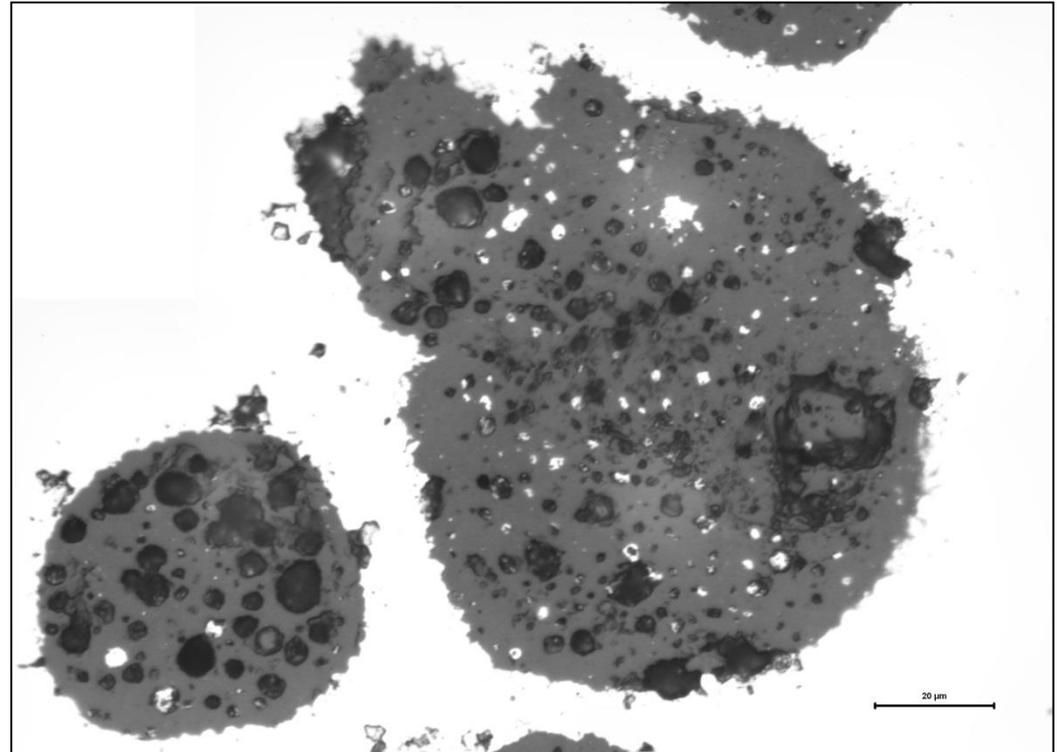

Ceramography of ITU 6 ($\text{Pu}_{0.23}\text{Am}_{0.2}\text{Zr}_{0.52}\text{O}_{1.8}$ + 60 vol% Mo)

Fresh fuel

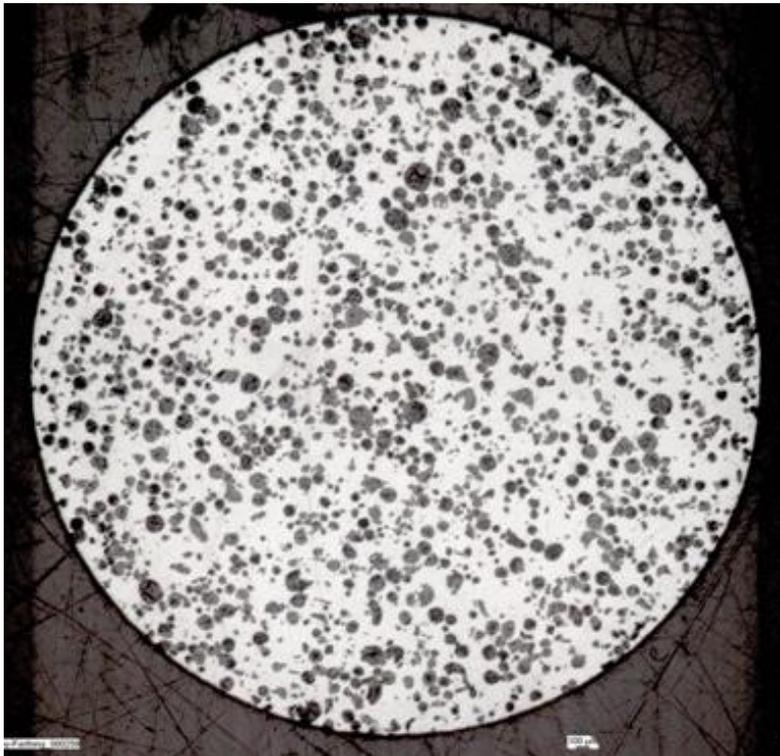

Irradiated fuel

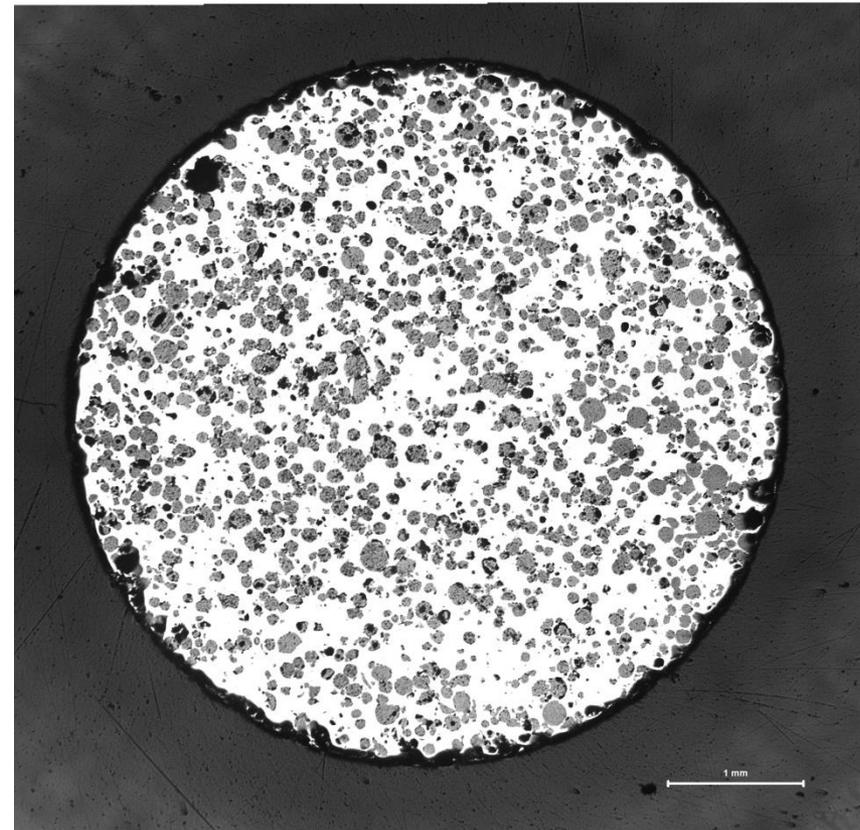

- No cracks in Mo matrix
- Particle at pellet boundary formed open porosity -> gas release

Ceramography of ITU 6

Fresh fuel

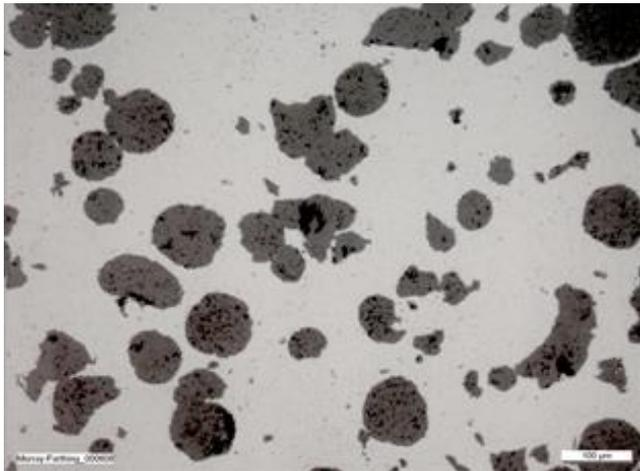

- No cracks in Mo matrix
- Metallic precipitates in particles
- Gas bubbles mainly located in particles
- "Finger"-like particle-matrix transition
- Halo around particles

Irradiated fuel

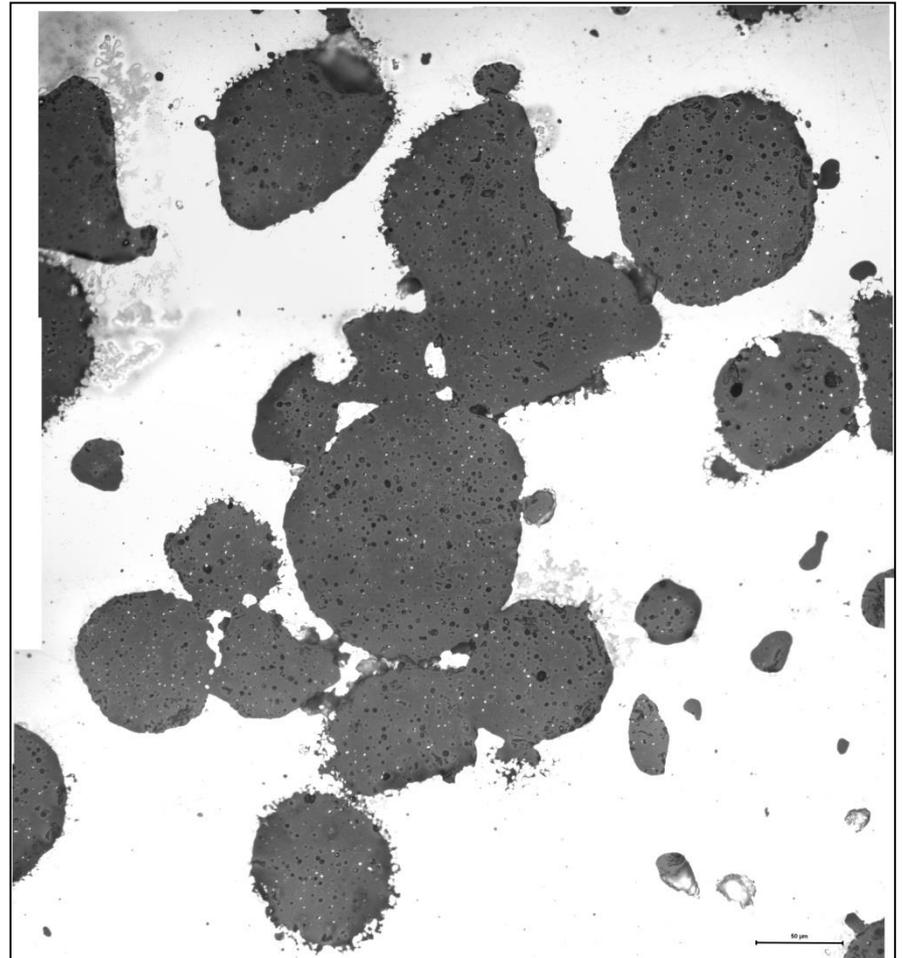

Recovery of CerCer Pellets

- Pellets were found loose inside pin, no indication of gap closure
- CEA 7
 - **8 of 15 pellets recovered in one piece**
- CEA 8
 - **5 of 15 recovered in one piece**
- Other pellets were extracted in relatively large fragments

MgO pellet being extracted (a) and F17 spacer (b), from pin CEA-8



a



b

extracted Am-bearing CERCER fuels from CEA-7

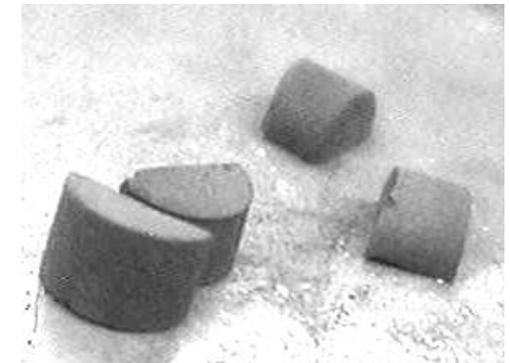

Pellet Metrology of CEA 7 & 8

Target #	Δ Height (%)	Δ Diameter (%)	Δ Geometrical density (%)
Futurix FTA 7			
5114	0,7	1,5	-3,6
5119	0,6	1,3	-3,1
5120	0,6	1,5	-3,4
5121	1,2	1,2	-3,6
5126	0,8	1,3	-3,3
5127	0,7	0,9	-2,5
5128	0,9	1,3	-3,4
5129	0,7	1,1	-2,8
Futurix FTA 8			
2112	1,1	1,1	-3,2
2113	0,9	1,2	-3,2
2117	0,7	1,4	-3,5
2124	0,8	0,7	-2,2
2120	0,3	1,5	-3,2

Consistent with results from gamma spectrometry, indicating circa 3% volume swelling.

Ceramography of CEA 7 ($\text{Pu}_{0.5}\text{Am}_{0.5}\text{O}_{1.88} + 80\text{vol}\% \text{MgO}$)

No significant evolution of the diameter of the pellets along the cuts; rounded shaped bubbles inside $(\text{Pu},\text{Am})\text{O}_{2-x}$ particles that probably host gases.

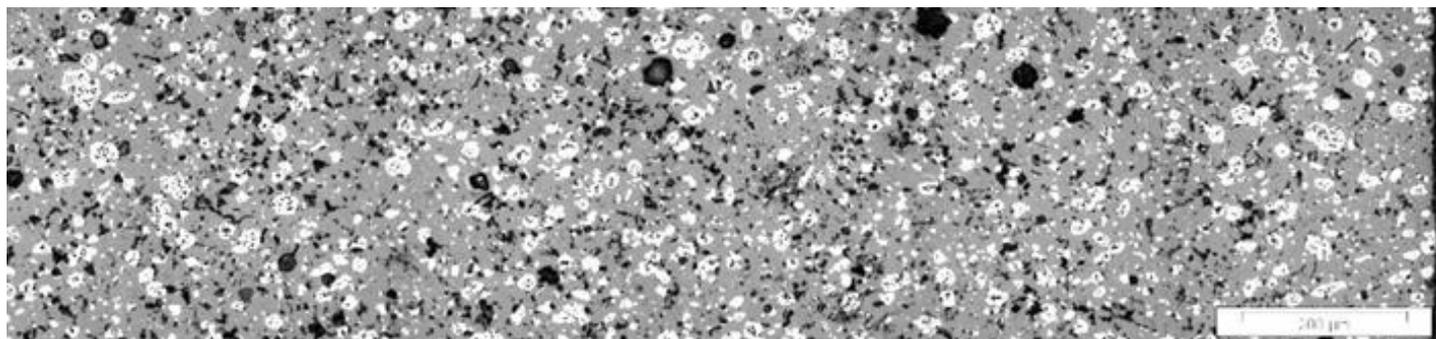
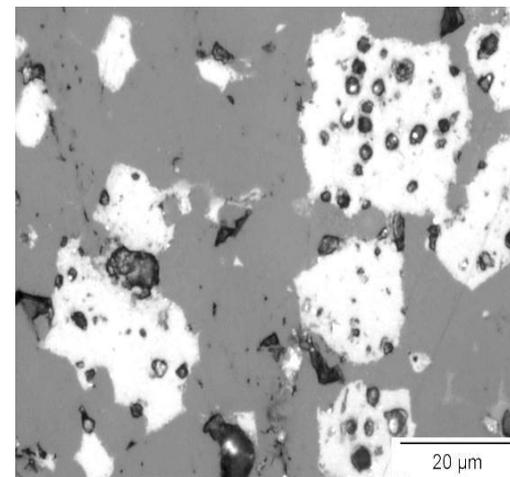
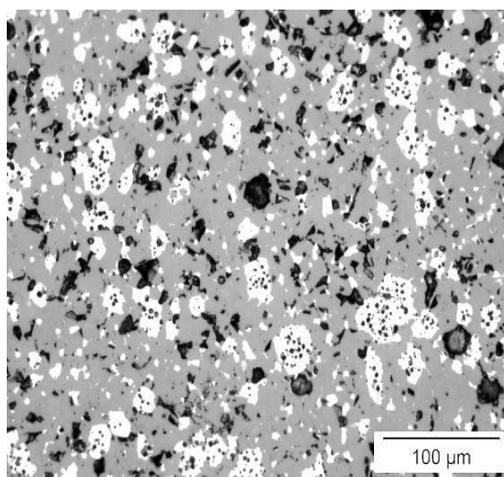
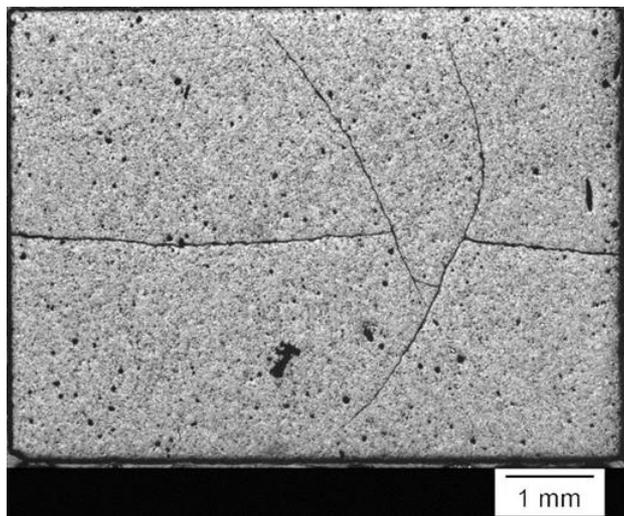

- > some cracks (consistent with broken pellets shapes)
- > metallic precipitates
- > gas bubbles mainly located in particles (consistent with low gas release rate)
- > secondary phase at MgO grain boundaries

Ceramography of CEA 8 ($\text{Pu}_{0.2}\text{Am}_{0.8}\text{O}_{1.73} + 75 \text{ vol\% MgO}$)

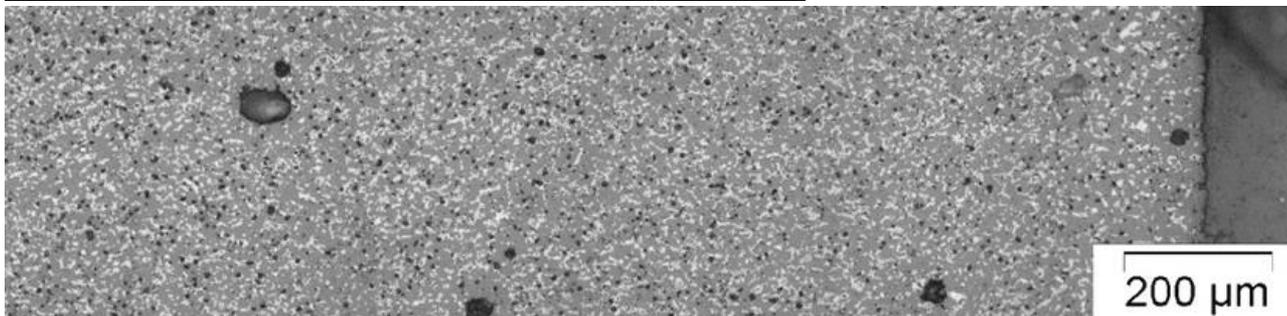
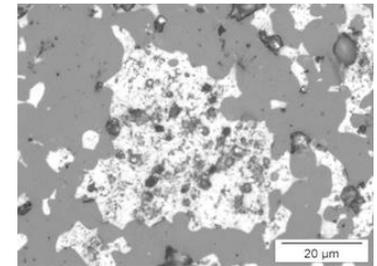
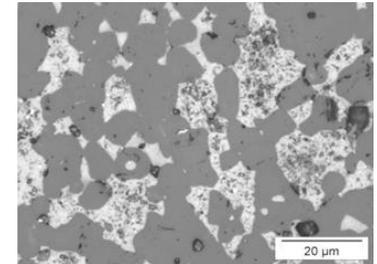
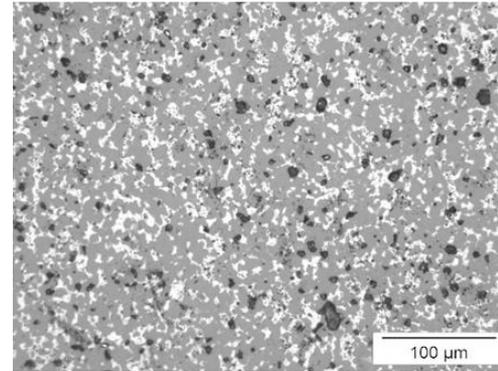
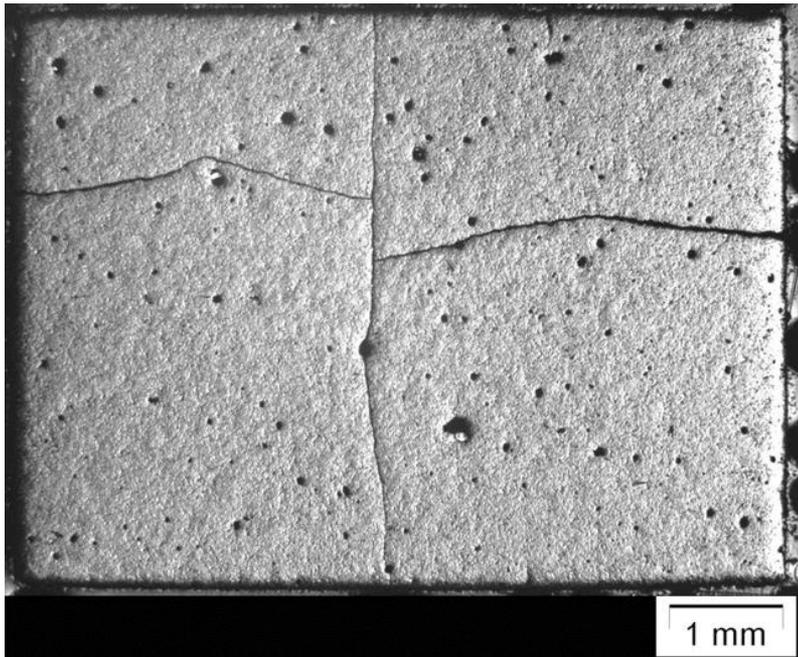

few cracks

- > gas bubbles mainly located in particles (but features different from CEA-7)
- > secondary phase at MgO grain boundaries ?

Summary 1/2

- Within the frame of the international collaboration **FUTURIX-FTA** as well as the European research programmes **EUROTRANS (FP6)** and **FAIRFUELS (FP7)** **CEA and JRC** have conducted together preparation, irradiation and **PIE** of **2 CerCer** and **2 CerMet** fuels for **transmutation of Am** in the **Phénix fast reactor**.
- CEA has achieved promising PIE results regarding CerCer fuels based on MgO matrix (CEA 7 & CEA 8):
 - **Non-significant elongations and deformation of the pins**
 - **No ^{137}Cs migration in the fuel stacks**
 - **Low Helium and Fission Gas release rates**
 - **A significant fraction of fuel pellets recovered as one piece**
 - **Moderate and similar pellet swelling ($\sim 3\%$) for both fuels (0.3–0.5 vol.%/at%)**
 - **Low hydrostatic density changes ($\sim 0,4\%$)**

Summary 2/2

- ITU has achieved promising PIE results regarding CerMet fuels based on Mo matrix (ITU 5 & ITU 6):
 - **No significant pin length elongation**
 - **No significant pin diameter change at position of the CerMet columns**
 - **No or very low fission product migration**
 - **No or very low Cs release from CerMet pellets**
 - **Pellet length changes ~5% & ~3% for ITU 5 & 6, respectively**
 - **Volume swelling circa 15% & 9% (0.7-0.9 vol.%/at%)**
 - **A fractional gas release of circa 30 % was measured for both pins**
 - **All pellets were recovered completely intact**
 - **No cracks inside the Mo matrix, Bubbles located inside particles**
 - **Outer particles formed open porosity during irradiation (improve synthesis in the future)**

Thank you for your attention!



Contact: Daniel Freis
European Commission – JRC
Directorate G – Nuclear Safety & Security
Nuclear Fuel Safety Unit
Daniel.Freis@ec.europa.eu

References

1. L. Donnet et. al., The FUTURIX-FTA Experiment in PHENIX: Status of fuel fabrication, Proceedings of GLOBAL 2005 Tsukuba, Japan, Oct 9-13, 2005, Paper No. 258
2. G. Cécilia, F. Delage, J. Lamontagne, L. Loubet, Post-Irradiation Examination results for MgO-CERCER Am-bearing fuels irradiated in PHENIX within the frame of the FUTURIX-FTA experiment, Proceedings of Global 2015, September 20-24, 2015 - Paris (France)
3. D. Papaioannou, R. Nasyrow, W. de Weerd, D. Freis, J. Somers, FAIRFUELS Deliverable 3.2.3, FUTURIX-FTA ITU-5 & ITU-6 Cer-Met PIE, JRC-ITU, Karlsruhe, Germany, 2015

Back-up slides

Material Data

Mo

- Molar mass 95.95 g/mol
- Density 10.28 g/cm³
- Thermal expansion 4.8 $\mu\text{m}/(\text{m}\cdot\text{K})$ (at 25 °C)
- Thermal conductivity 138 W/(m·K)
- Specific heat 250 J/kg.K
- Melting point 2896 K (2623 °C, 4753 °F)

MgO

- Molar mass 40.30 g/mol
- Density 3.58 g/cm³
- Thermal expansion 9-12 $\mu\text{m}/(\text{m}\cdot\text{K})$
- Thermal conductivity 45 - 60 W/(m·K)
- Specific heat 880 – 1030 J/kg.K
- Melting point 3125 K (2852 °C, 5166 °F)



FX 5 & 6

Table 1.- Impurity analysis of molybdenum metal

Element µg/g	Concentration	Element	Concentration µg/g
Na	22.99 ± 2.76	Ce	3.91 ± 0.47
Mg	9.14 ± 1.10	Re	2.83 ± 0.34
Al	19.29 ± 2.32	W	80.80 ± 9.70
Rb	0.72 ± 0.09	Pb	20.22 ± 2.43
Y	0.12 ± 0.01	Bi	0.18 ± 0.02
Ru	2.78 ± 0.33	V	0.47 ± 0.06
Cd	1.19 ± 0.14	Cr	8.03 ± 0.96
Ag	0.17 ± 0.02	Mn	1.16 ± 0.14
Sb	0.67 ± 0.08	Fe	93.21 ± 11.19
Cs	0.89 ± 0.11	Co	0.43 ± 0.05
Ba	1.00 ± 0.12	Cu	3.90 ± 0.47
La	0.05 ± 0.01	K	30.03 ± 3.60

Table 1.-Am and Pu content in the beads

	FX5	FX6
Beads	PuO ₂	(Zr,Pu)O ₂
Analysis number	3458	3459
Pu (wt%)	68.65 ± 0.89	28.42 ± 0.37
Am (wt%)	17.59 ± 0.14	30.05 ± 0.24
Zr (wt%¹)		25.31
Am/ΣM	20.4	35.9

Table 2.- Isotopic composition of plutonium (analysis 08.08.2005)

TIMS	
²³⁸ Pu	0.01535
²³⁹ Pu	90.6340
²⁴⁰ Pu	9.11570
²⁴¹ Pu	0.16188
²⁴² Pu	0.07263

Table 3.- Particle size distribution of plutonium compounds following calcination.

Range µm	FX5 (%wt)	FX6 (%wt)
>225	0.02	0.03
125-225	28.24	38.51
90-125	47.21	38.07
63-90	21.82	14.24
32-63	2.33	6.03
<32	0.38	3.11

Profilometry ITU-6

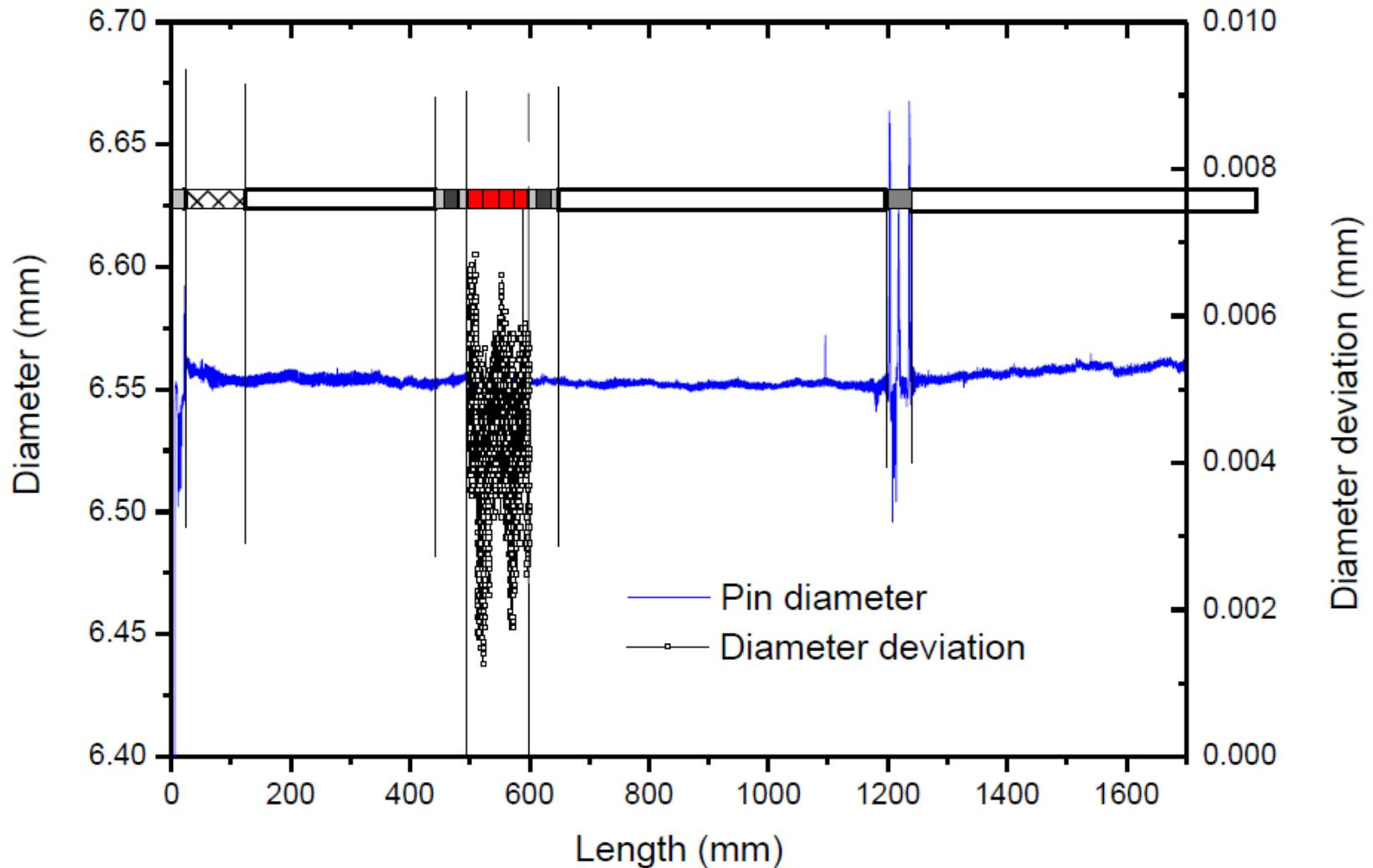

Gamma Spectrometry of ITU-5 (^{60}Co)

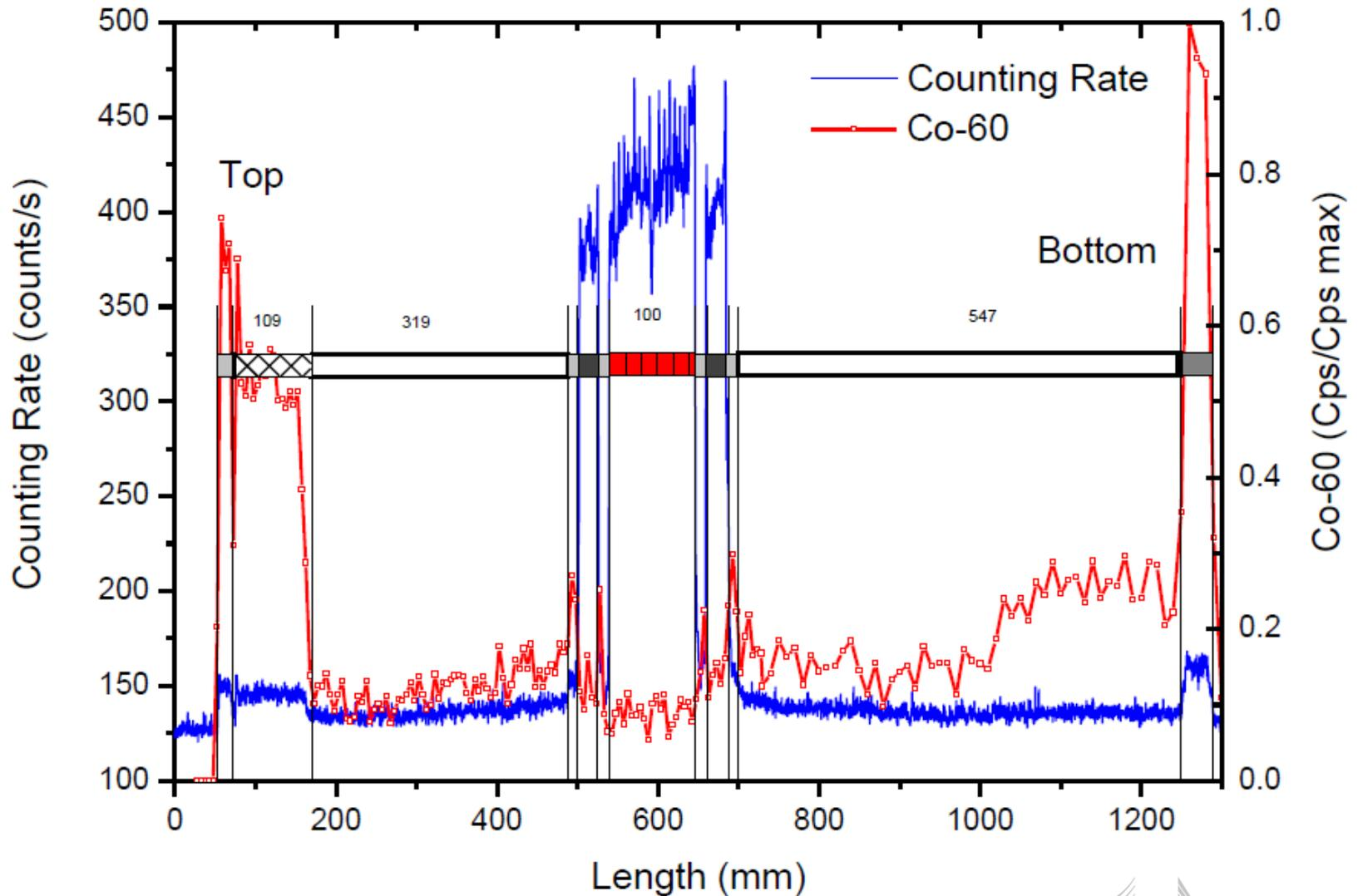

Gamma Spectrometry of ITU-5 (^{106}Ru)

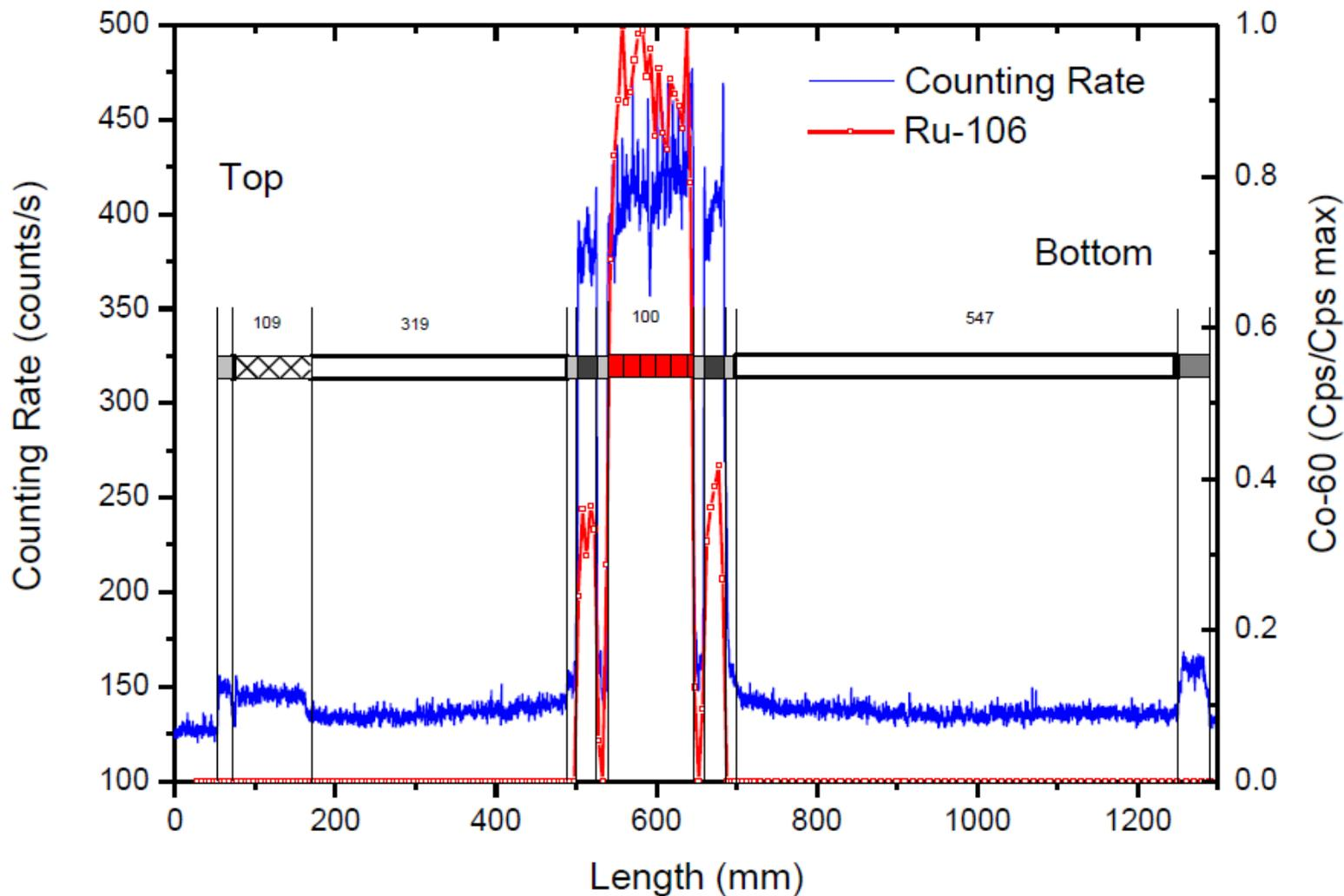

Gamma Spectrometry of ITU-5 (^{125}Sb)

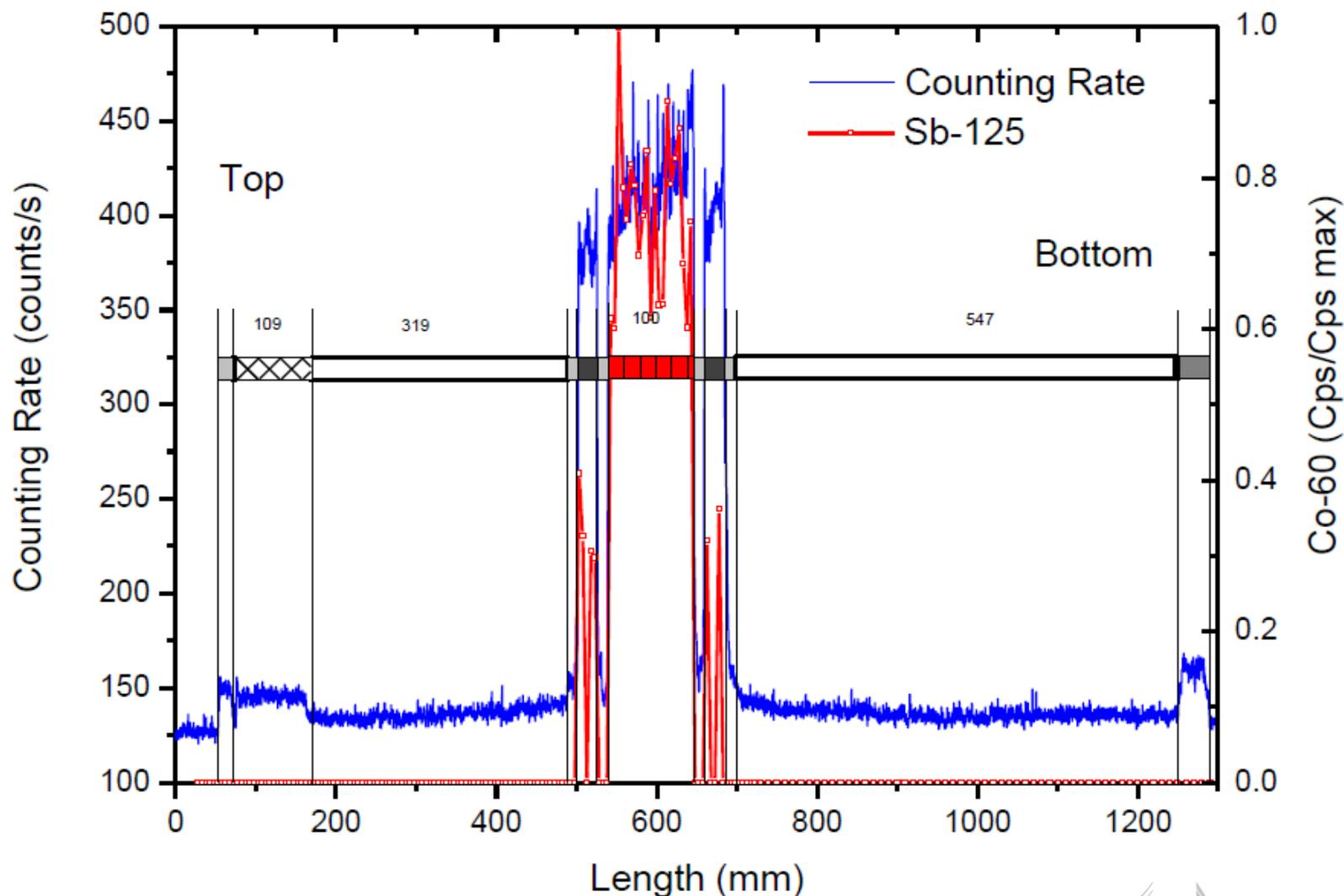

Gamma Spectrometry of ITU-5 (^{154}Eu)

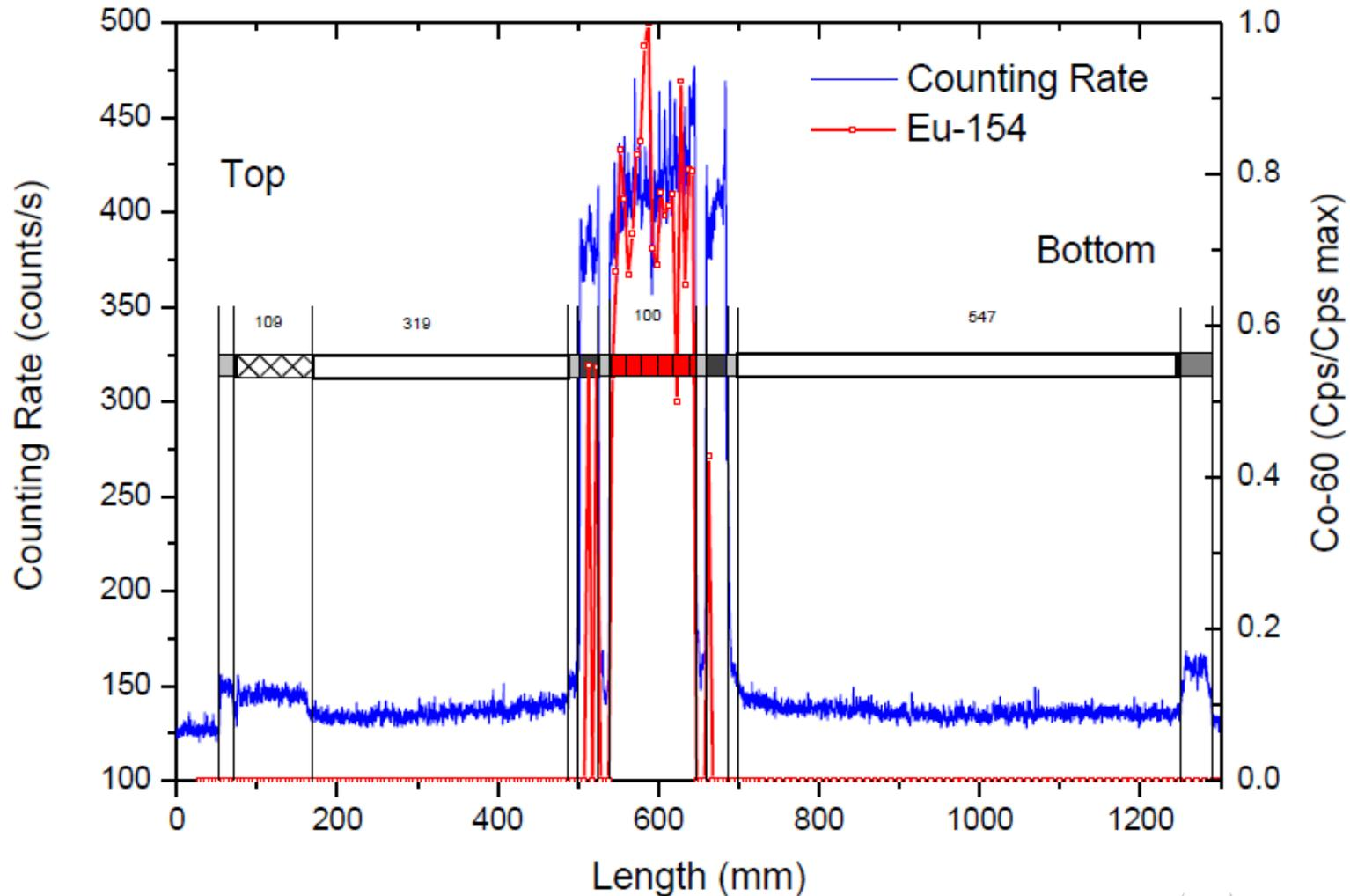

Gamma Spectrometry of ITU-6 (^{137}Cs)

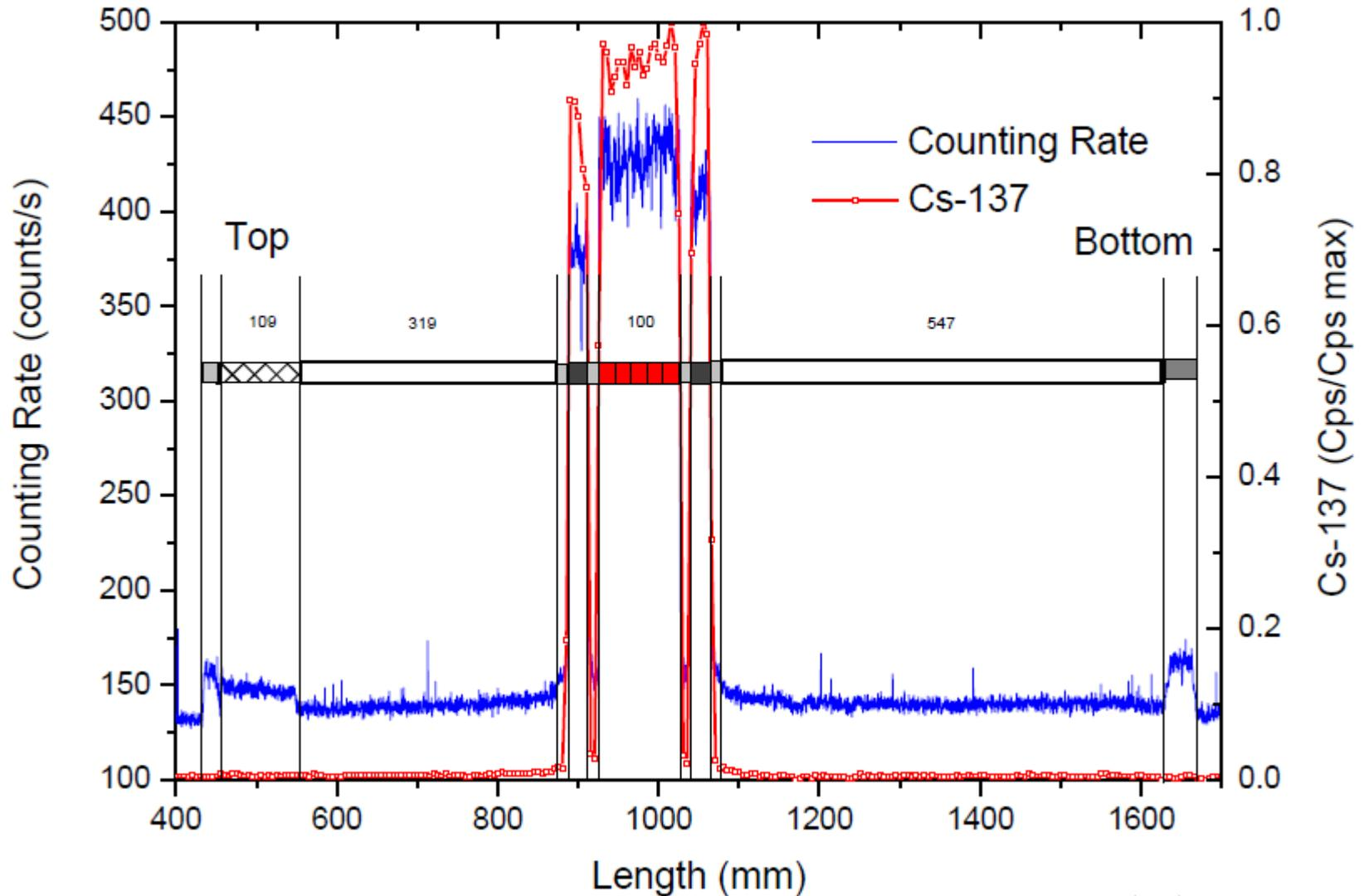

Gamma Spectrometry of ITU-6 (^{134}Cs)

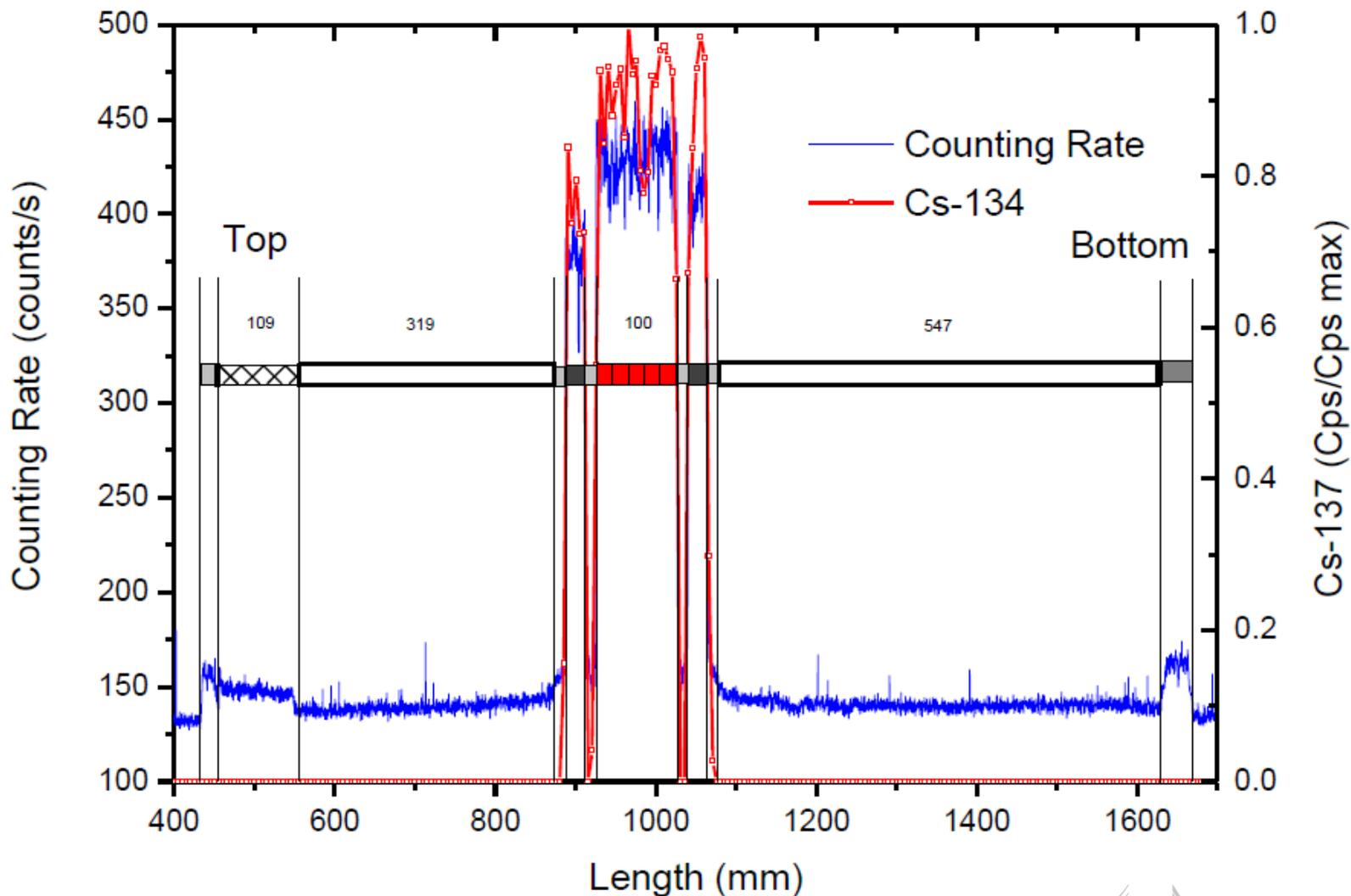

Gamma Spectrometry of ITU-6 (^{60}Co)

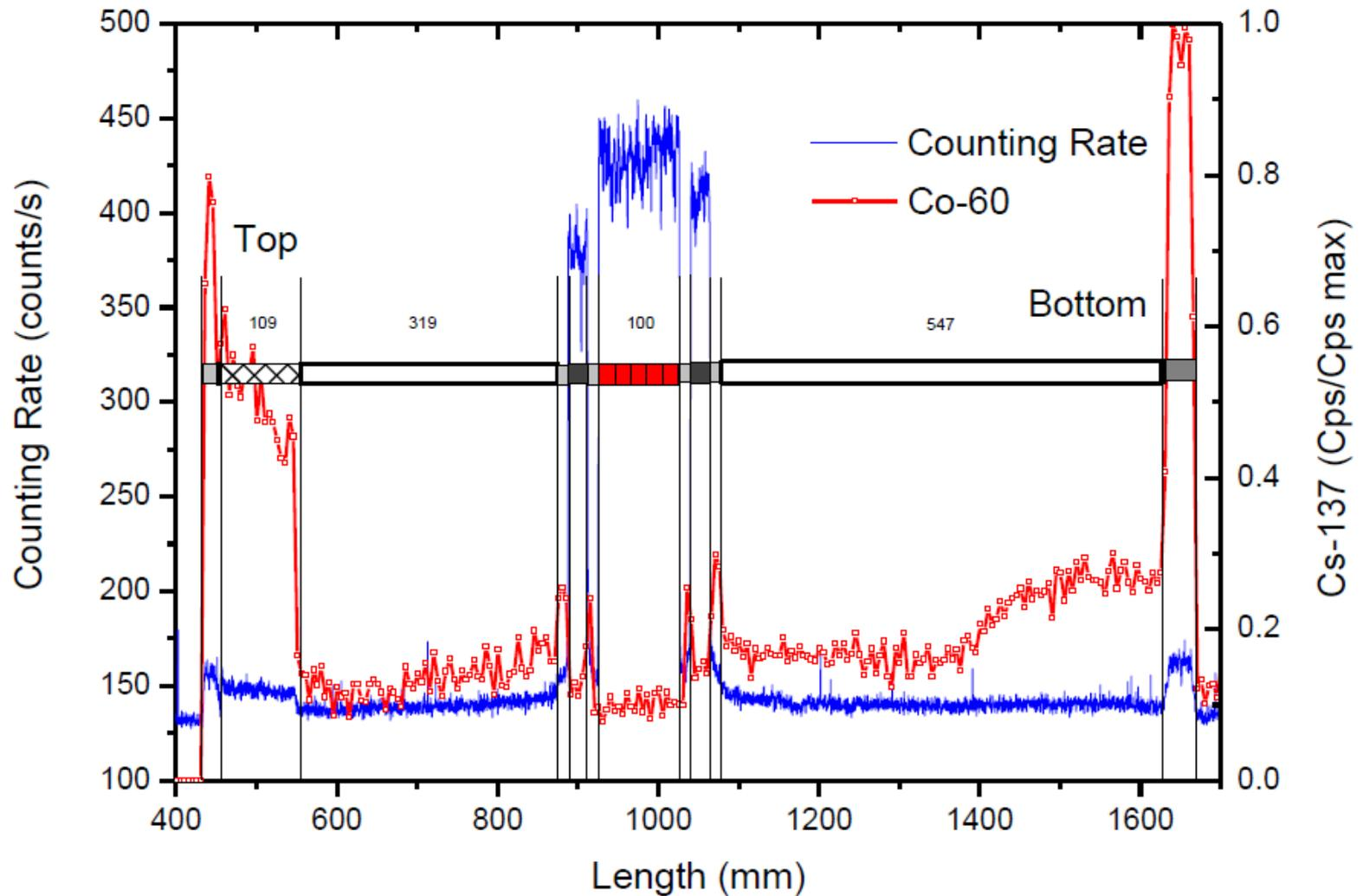

Gamma Spectrometry of ITU-6 (^{54}Mn)

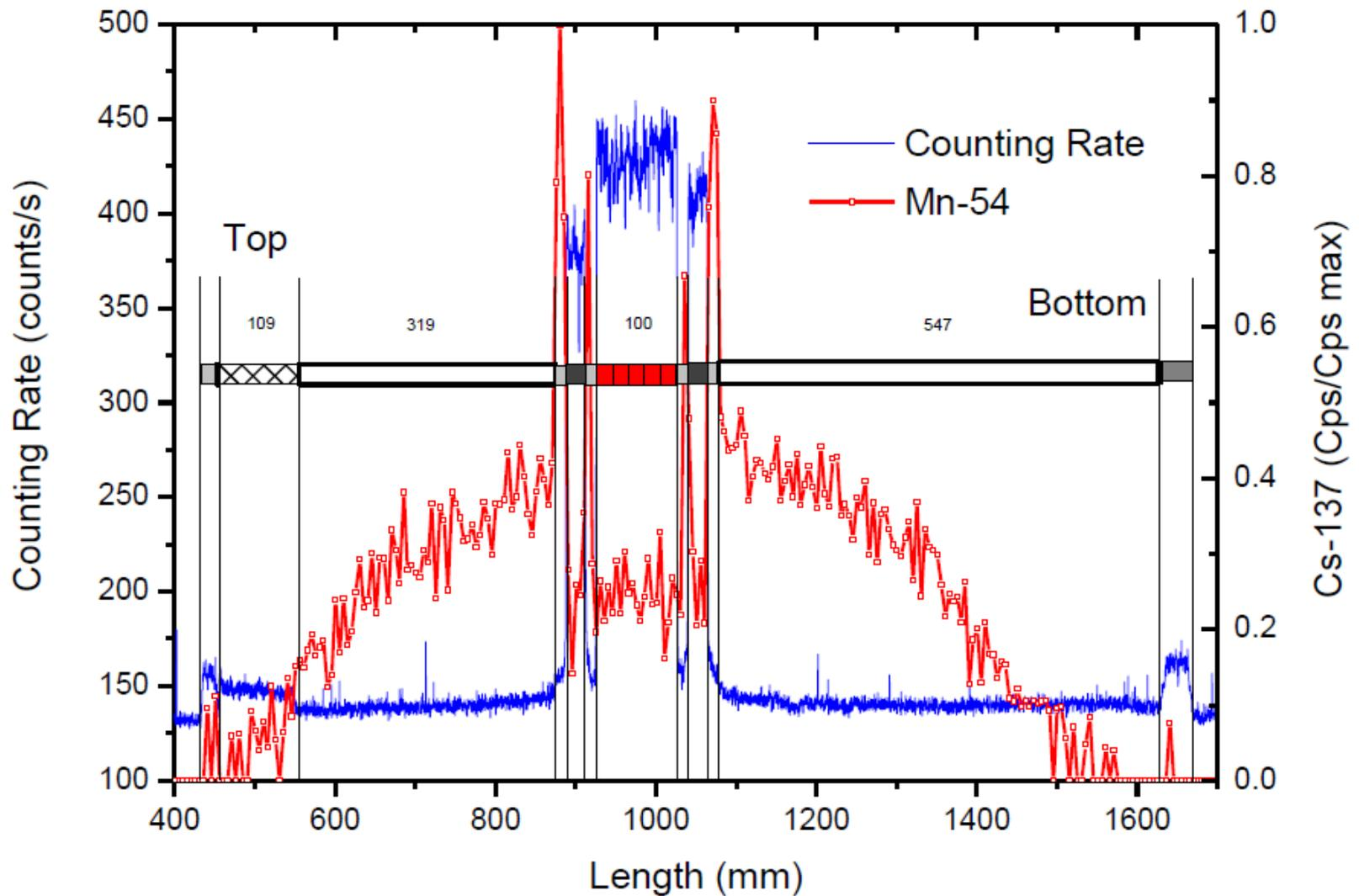

Determination of Pellet Positions ITU-6

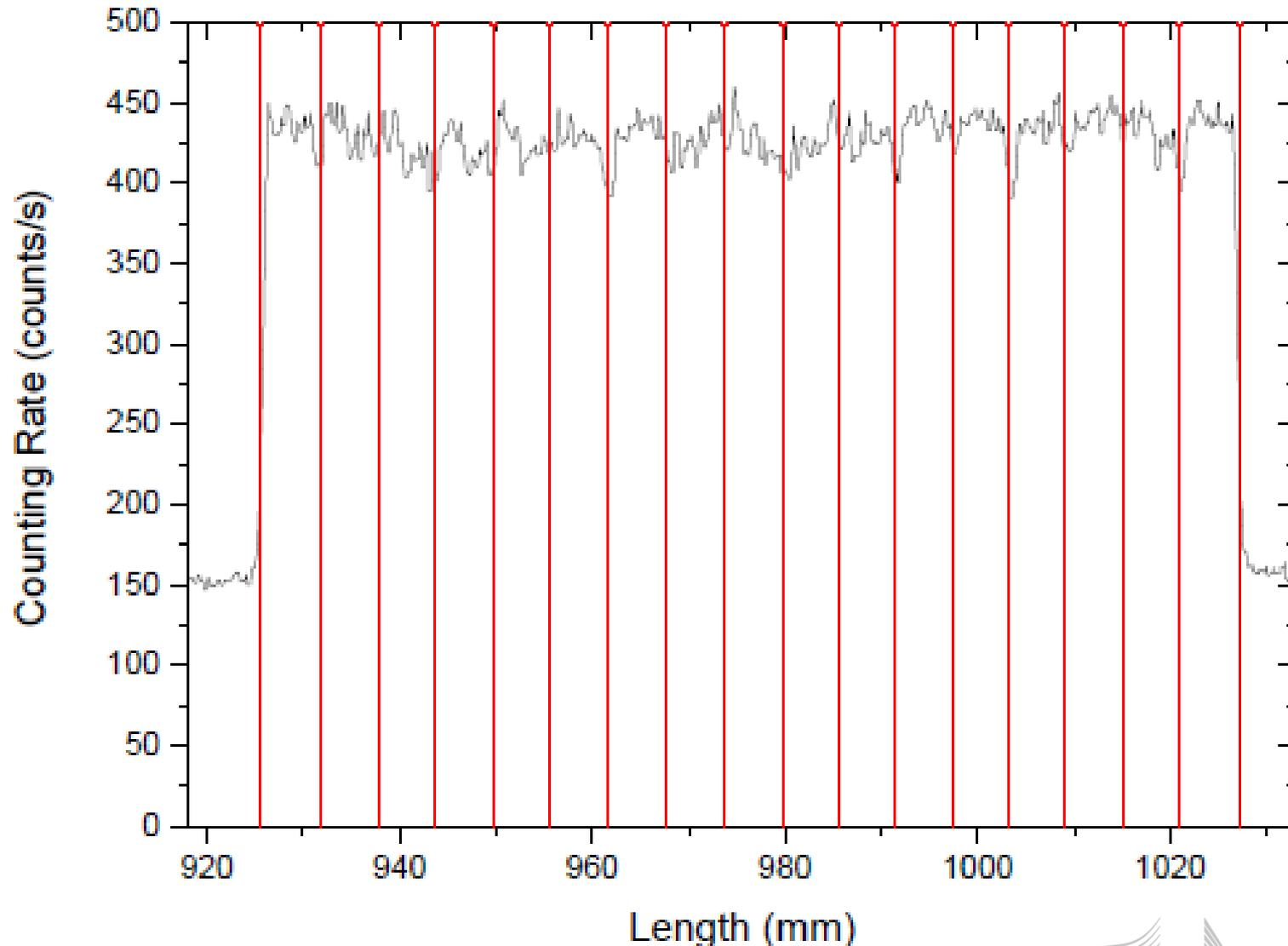

Gas Puncturing Results

Pin ID	ITU-5	ITU-6	CEA-7	CEA-8
Date of puncturing	June 2015		February 2014	
Pressure at puncturing stage (MPa)	0.148	0.195	0.106	0.118
Free volume in the pin(cm ³)	19.18	18.93	18.9±3.1	18.9±3.2

Initial free volume: 18.6 ml

Pin	ITU-5	ITU-6	CEA-7	CEA-8
%H ₂	-	-	0.002	0.002
% He	83.23	87.18	98.942	99.336
% Xe	14.34	10.3	0.466	0.100
% Kr	2.04	2.02	0.033	0.008
% O ₂	0.03	0.04	0.102	0.065
% N ₂	0.11	0.12	0.425	0.330
% Ar	0.05	0.14	0.024	0.154
% CO ₂	0.19	0.21	0.006	0.005

The Joint Research Centre – Directorate G

Willi Mondelaers HoU G.2	Paulo Peerani HoU G.III.9
Franck Wastin HoU H.10	Peter Haehner HoU G.I.4



JRC-ITU Director
Maria Betti



Head of Unit R.6
Jacqueline Ribeiro



Head of Department G.III
Vincenzo Rondinella



Head of Unit G.III.8
Joseph Somers



Head of Unit G.I.5
Robert Gaciutto



Head of Department G.II
Willem Janssens



HoU G.1
Ralph Maier



HoU G.I.3
Rudy Konings



HoD G.I
Jean-Paul Glatz



HoU G.II.6
Klaus Lutzenkirchen

Facilities and Equipment at JRC Karlsruhe

24 hot cells with capacities up to **1 Mio Curies** and some **400 glove boxes** in **30 alpha-laboratories**.

Minor Actinide Lab for preparing **irradiation targets** containing amounts of **actinides** for **transmutation** experiments

Clean Lab category 10-100-Large Geometry SIMS for safeguards and nuclear forensic applications

Destructive and non-destructive analyses

Basic materials science investigations

- Materials studies down to 1 K and up to 8000 K and 60 GPa
- Photo-electron spectroscopy, X-ray diffraction, (electrical resistance and optical properties) on highly radioactive samples, Mössbauer spectroscopy at normal and elevated pressures
- High-resolution electron microscopes,
- Shielded microprobes,

