



HAL
open science

Understanding of radiation effects and damage in nuclear reactors materials using JANNuS ion beams

C. Cabet, A. Gentils

► **To cite this version:**

C. Cabet, A. Gentils. Understanding of radiation effects and damage in nuclear reactors materials using JANNuS ion beams. EUROMAT 2017 / Symposium D9, Sep 2017, Thessalonique, Greece. cea-02434523

HAL Id: cea-02434523

<https://cea.hal.science/cea-02434523>

Submitted on 10 Jan 2020

HAL is a multi-disciplinary open access archive for the deposit and dissemination of scientific research documents, whether they are published or not. The documents may come from teaching and research institutions in France or abroad, or from public or private research centers.

L'archive ouverte pluridisciplinaire **HAL**, est destinée au dépôt et à la diffusion de documents scientifiques de niveau recherche, publiés ou non, émanant des établissements d'enseignement et de recherche français ou étrangers, des laboratoires publics ou privés.

EUROMAT 2017/ Symposium D9

Thessaloniki, Greece, September 17-22, 2017

Understanding radiation effects and damages in nuclear reactor materials using JANNuS ion beams

DE LA RECHERCHE À L'INDUSTRIE

cea



<http://jannus.in2p3.fr>

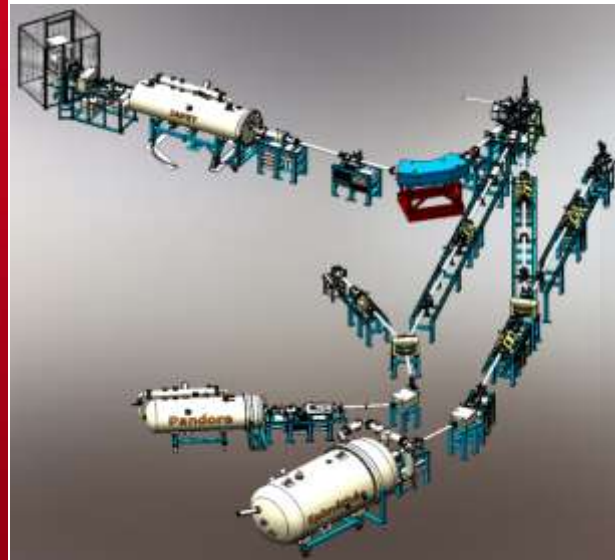

Céline Cabet, Aurélie Gentils,
Université Paris-Saclay, France

JANNuS: 1 platform, 2 facilities

Joint Accelerators for Nanoscience and Nuclear Simulation

GIS JANNuS (scientific interest grouping since 2004)

→ Founding partner of the French accelerator network



<http://emir.in2p3.fr>

→ Simulation of damage accumulation induced by neutrons in nuclear materials

JANNuS Orsay

on line TEM coupled to one or two beams

JANNuS Saclay

triple beam irradiation facility with high damage rate

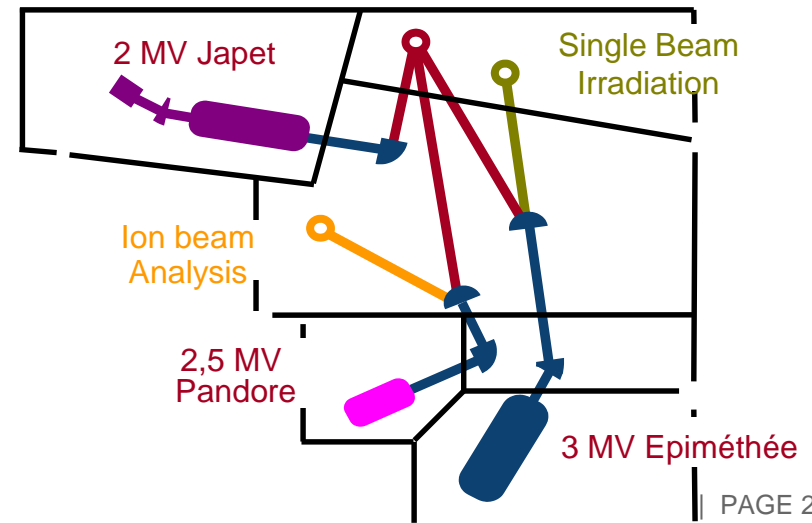
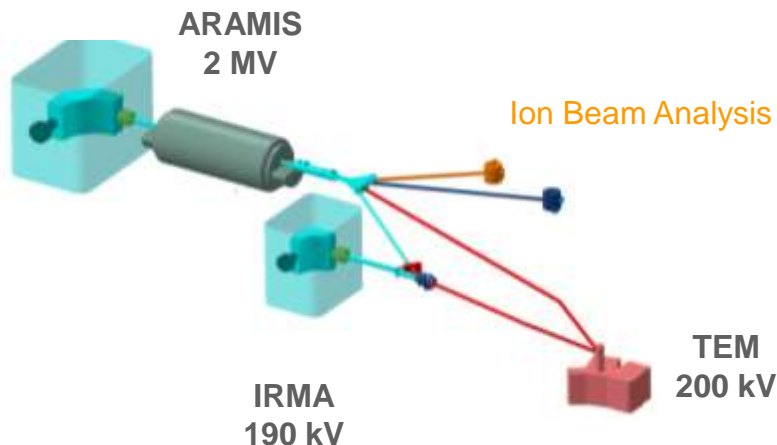

ARAMIS
2MV Tandem - VdG
0.5 – 11 MeV *
10 nA – 10µA

> 40 elements
* limited to 1 MeV per charge state inside the TEM

Ion Beam Analysis
RBS, RBS/C, ERDA,
PIXE, µPIXE, PIGE

implantation / irradiation
LN₂ → 1000°C

TRANSMISSION ELECTRON MICROSCOPE
200 kV FEI Tecnai G2 F20 Twin
Resolution: 0.25 nm
Magnification range: 70-700 000

IRMA
190 kV ion implanter
10-570 keV
up to 20 mA
almost every element

in situ RBS/C
and implantation
LN₂ → 600°C



in situ dual ion beam TEM
high resolution camera
EDX, GIF (EELS, EFTEM...), STEM
-170° C up to 1300° C

ARAMIS ion accelerator

2MV Tandem – VdG

HOME BUILT IN 1987

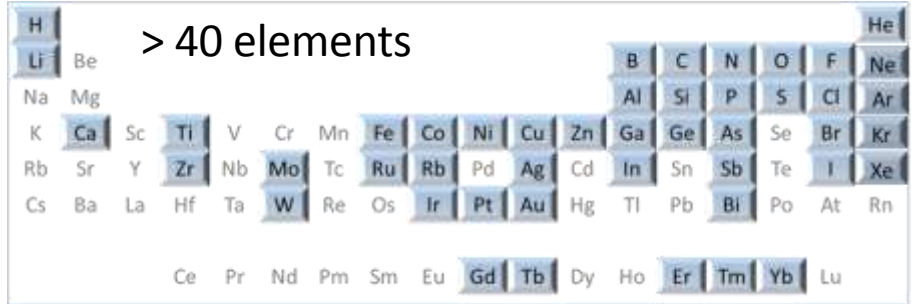

VAN DE GRAEFF MODE
 Mainly H, He (also noble gaz)
 200 keV – 1.8 MeV (H), 3.6 MeV (He)
 Positive Penning ion source
 > 20 μ A

TANDEM MODE
 0.5-11* MeV, 10 nA – 10 μ A
 SNICS SOURCE (Source of Negative Ions by Cesium Sputtering)
 * limited to 1 MeV per charge state inside the TEM

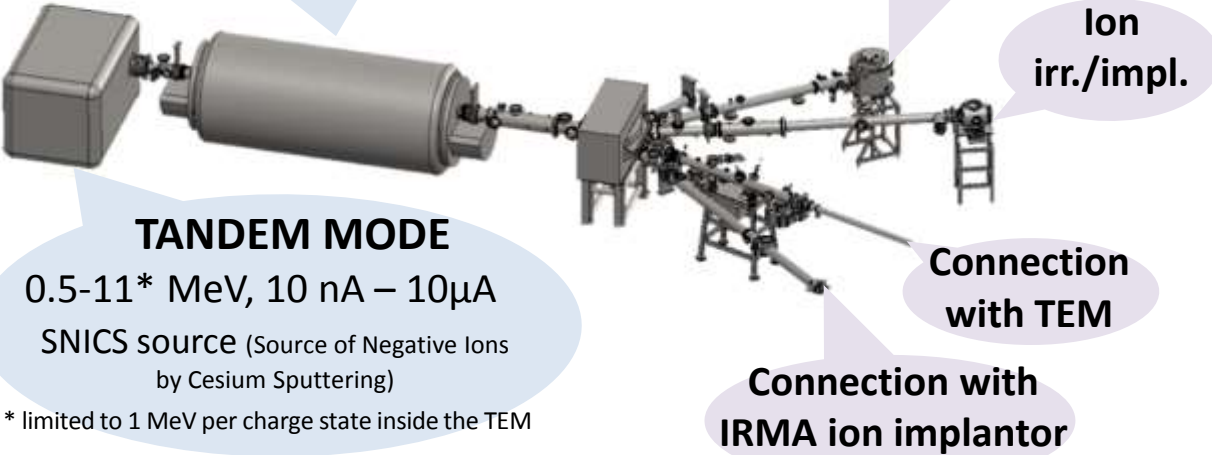

Ion beam analysis
 (RBS, RBS/C, ERDA, PIXE, μ PIXE, PIGE)

Ion irr./impl.

Connection with TEM

Connection with IRMA ion implantor

- Typical irradiation conditions:**
- Rastered beam
 (80 Hz vertical and 400 Hz horizontal)
 - Average flux range
 $1.10^{10} - 5.10^{11} \text{ cm}^{-2} \cdot \text{s}^{-1}$
 (depending on ions and energies)
 - Temperature LN₂ -> >1000°C
 (thermocouple control)

IRMA 190 kV ion implanter



HOME BUILT IN 1979

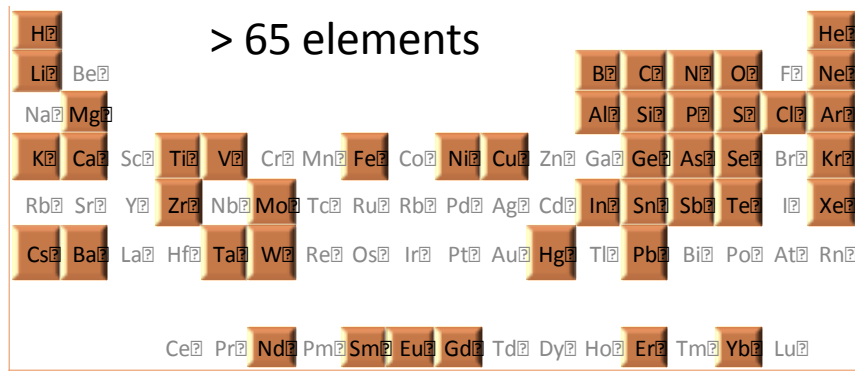

2 MV ARAMIS
accelerator

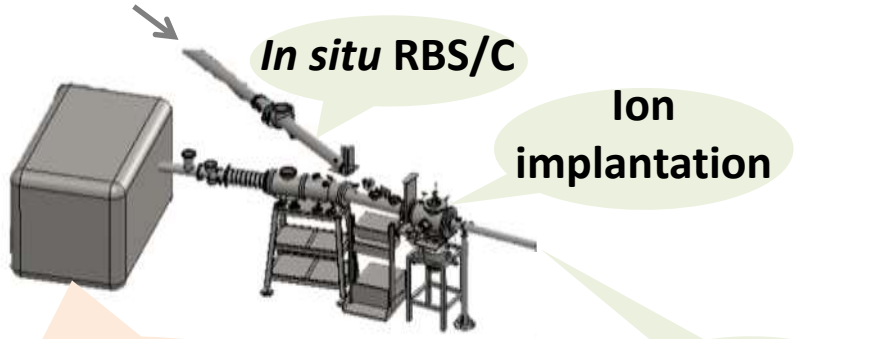

Bernas-Nier ion source
10-570 keV
up to 20 mA

- Typical irradiation conditions:
- Rastered beam
(400 Hz vertical and 80 Hz horizontal)
 - Average flux range
 $1 \cdot 10^{10} - 5 \cdot 10^{12} \text{ cm}^{-2} \cdot \text{s}^{-1}$
(depending on ions and energies)
 - Temperature $\text{LN}_2 \rightarrow 1000^\circ\text{C}$
(thermocouple control)

In situ dual ion beam Transmission Electron Microscope

1st TEM (120 kV EM400) connected to IRMA ion implanter in 1980

3rd TEM (200 kV FEI Tecnai G² F20 Twin, shown below) since 2009 for external users

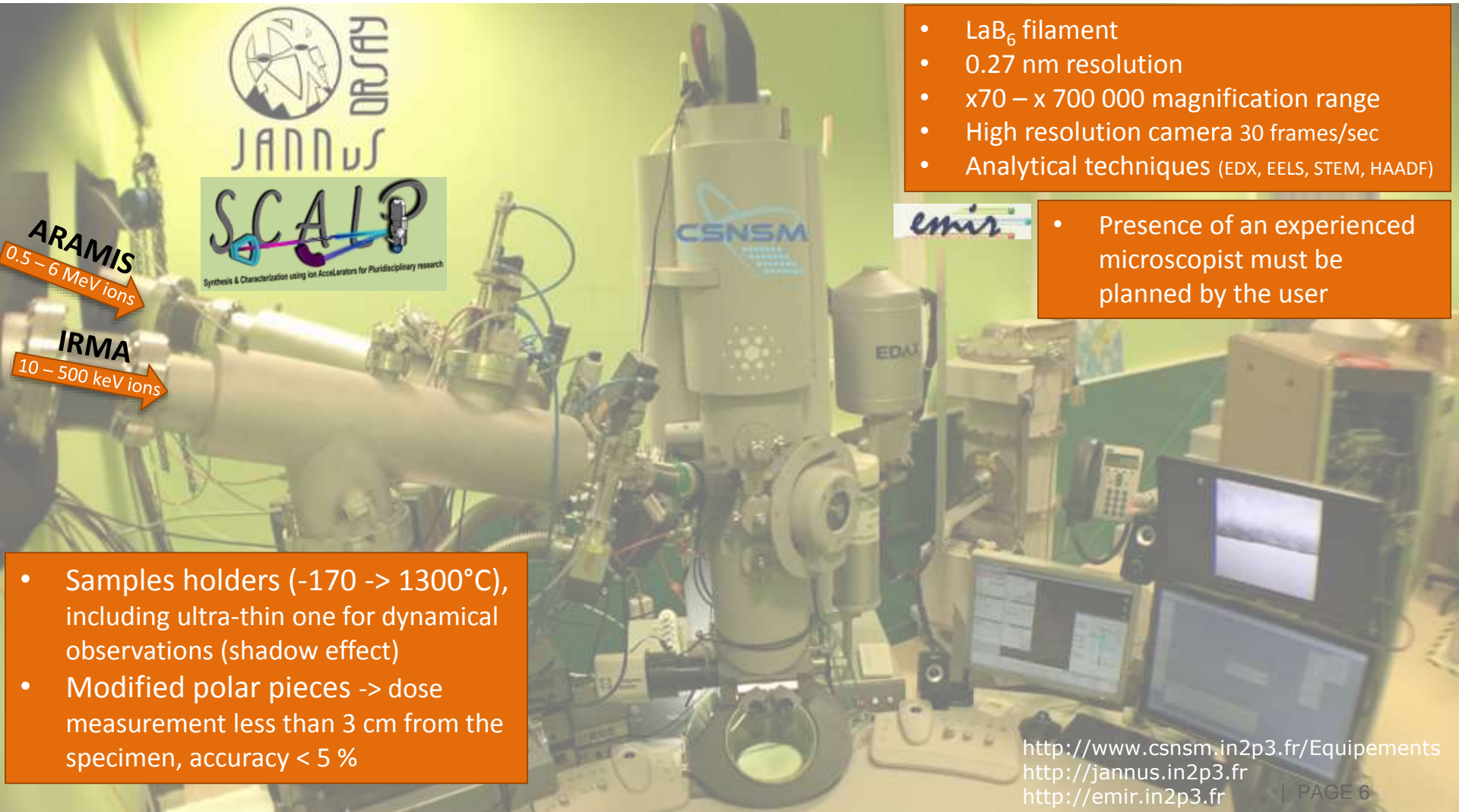

- LaB₆ filament
- 0.27 nm resolution
- x70 – x 700 000 magnification range
- High resolution camera 30 frames/sec
- Analytical techniques (EDX, EELS, STEM, HAADF)

- Presence of an experienced microscopist must be planned by the user

ARAMIS
0.5 – 6 MeV ions

IRMA
10 – 500 keV ions



- Samples holders (-170 -> 1300°C), including ultra-thin one for dynamical observations (shadow effect)
- Modified polar pieces -> dose measurement less than 3 cm from the specimen, accuracy < 5 %

New and future developments

- **EDX update**

Chemical analysis => Bruker Flash 6 detector and Esprit software -> hyper-maps



- **New ultra-fast high resolution camera**

High quality image (4K)
+ high-speed video capture (25 fps at 4K up to 300 fps at 512x512)
+ ultra fast shutter = **great tool for *in situ* imaging !**



- **Environmental sample holder**

Liquid and/or gas under irradiation with heating control (+ options)



- **Straining heating holder (1000°C)**

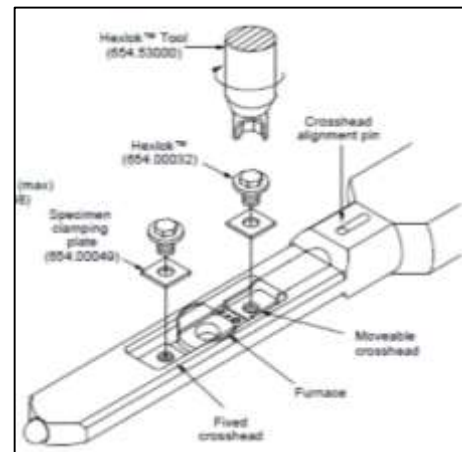

JANNuS-Saclay: 3 complementary accelerators

Heavy ion damage
 Hydrogen
 implantation

First triple beam irradiation
 in March 2010



Japet
 Tandem 2 MV

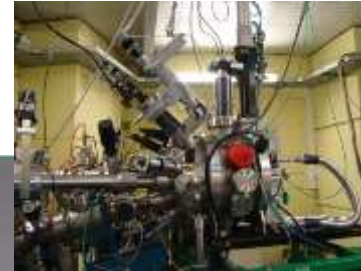

Chambre
 triple faisceau

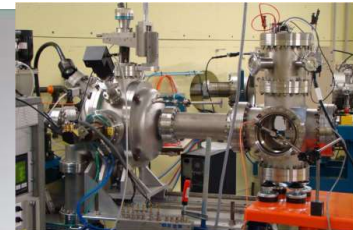

Chambre
 mono faisceau



Pandore
 Pelletron 2.5 MV



Y8

Y4



Epiméthée
 Pelletron 3 MV

Heavy ion damage
 Helium and
 hydrogen
 implantation

Helium and
 hydrogen
 implantation

- Accelerator: 3 MV Pelletron NEC (National Electrostatics Corporation) with a ECR (Electron Cyclotron Resonance) source from Pantechnik



- ⇒ Positive multi-charged ions
 $1 < m < 209$
 $400 \text{ keV} < E < 40 \text{ MeV}$

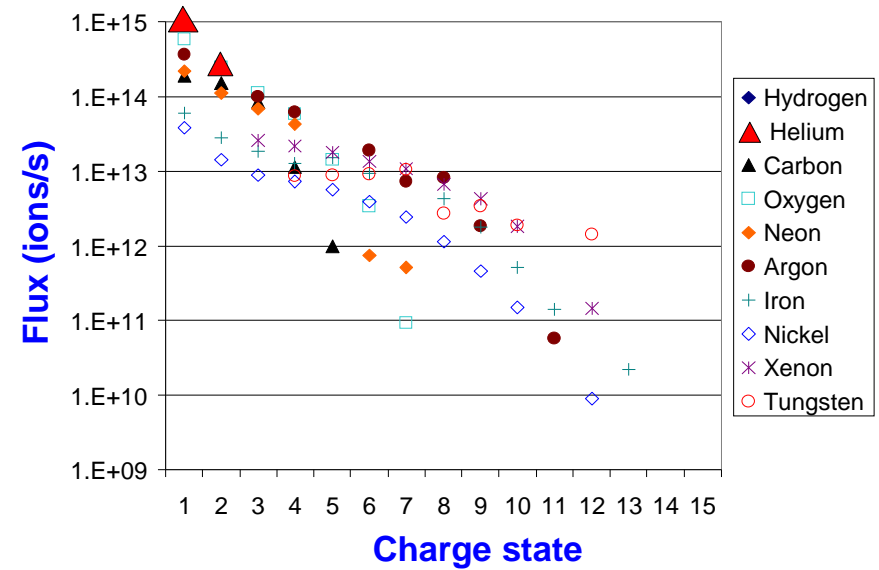

Ballistic damage with Fe (~10 dpa/h)

JANNuS-SACLAY: 2 MV Tandem **Japet** and 2.5 MV Pelletron **Pandore**

JAPET 2 MV Tandem with Source of Negative Ions by Cesium Sputtering (SNICS II)



PANDORE 2.5 MV Pelletron with Radio Frequency source



⇒ Negative single-charged ions are converted into positive multi-charged ions through the stripper

⇒ Single-charged gasses: H, He, D, N, Ar

		Epiméthée		Japet								Pandore																							
				3	4	5	6	7	8	9	10	11	12	13	14	15	16	17	18																
1	H	2	He																																
3	Li	4	Be																																
11	Na	12	Mg																																
19	K	20	Ca	21	Sc	22	Ti	23	V	24	Cr	25	Mn	26	Fe	27	Co	28	Ni	29	Cu	30	Zn	31	Ga	32	Ge	33	As	34	Se	35	Br	36	Kr
37	Rb	38	Sr	39	Y	40	Zr	41	Nb	42	Mo	43	Tc	44	Ru	45	Rh	46	Pd	47	Ag	48	Cd	49	In	50	Sn	51	Sb	52	Te	53	I	54	Xe
55	Cs	56	Ba	57	La	58	Hf	59	Ta	60	W	61	Re	62	Os	63	Ir	64	Pt	65	Au	66	Hg	67	Tl	68	Pb	69	Bi	70	Po	71	At	72	Rn
87	Fr	88	Ra	89	Ac	90	Rf	91	Db	92	Sg	93	Bh	94	Hs	95	Mt	96	Ds	97	Rg														

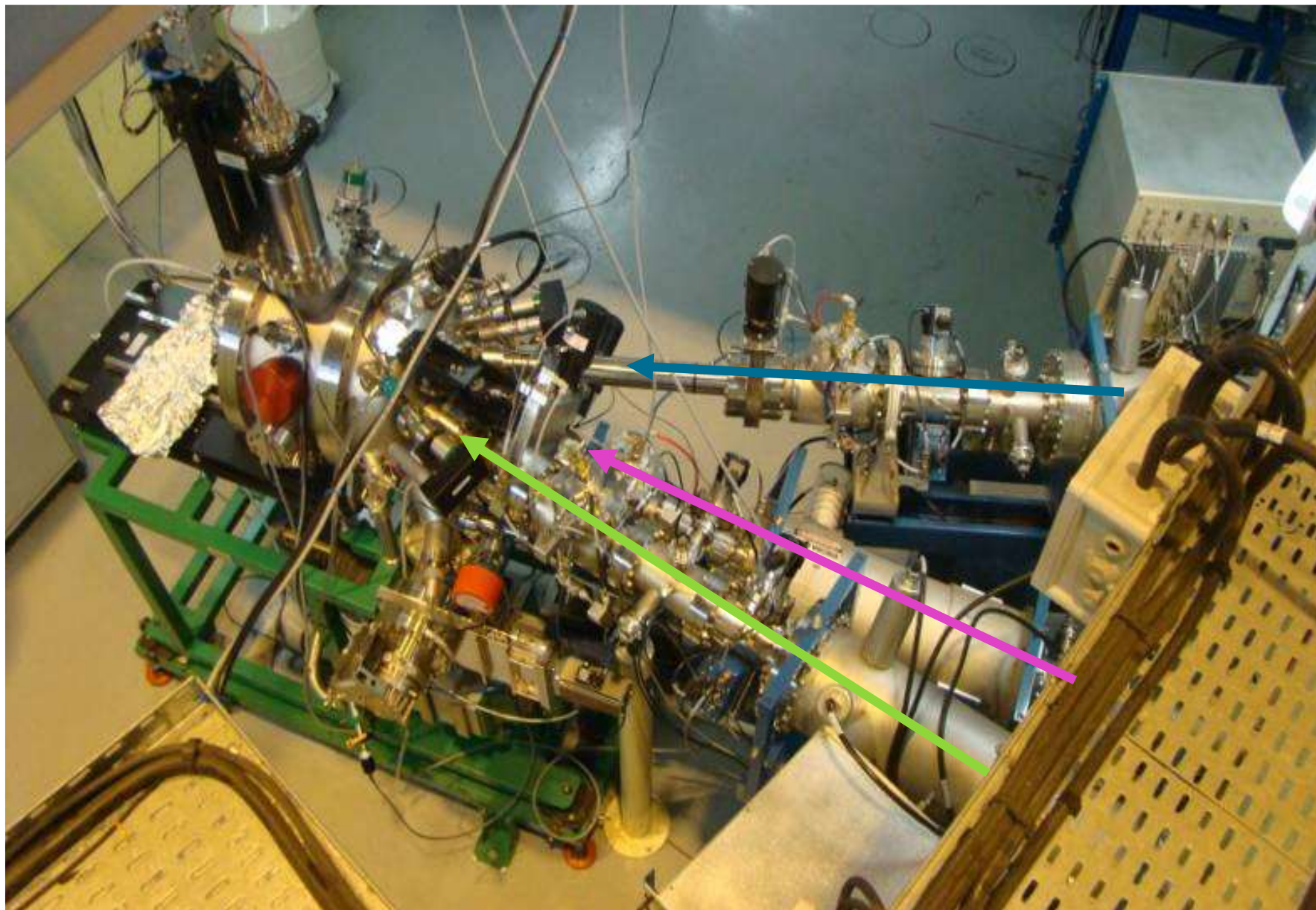

Complementary laser in the Raman spectrometer

- new laser with 633 nm in addition to the 532 nm

Retrofit of the IBA chamber

- New detectors
- Specimen deck with 2 to 6 degrees of freedom allowing for canalization

High temperature chamber

- Extension of the single beam chamber for irradiation at homogenous temperature up to 1200°C

Cryogenic chamber with resistivity recovery measurement

- Cryogenic irradiation at 30K
- Controlled step by step annealing
- On line measurement of sample resistivity (defect population and mobility)



Radiation stability of nano-oxides in ODS steels

Example 1: M.-L. Lescoat, J. Ribis, Y. de Carlan et al.

In situ TEM at JANNuS-Orsay

■ Nano particle evolution

~23 dpa

Fe⁺ 150 keV, 500°C
 ϕ 3.7 10¹² ion.cm⁻².s⁻¹
 Φ_{max} 1.6 10¹² ion.cm⁻².s⁻¹
 (~45 dpa)

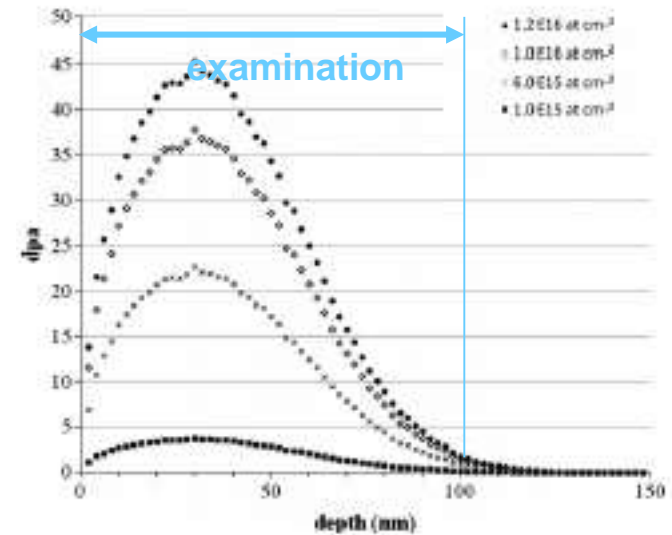
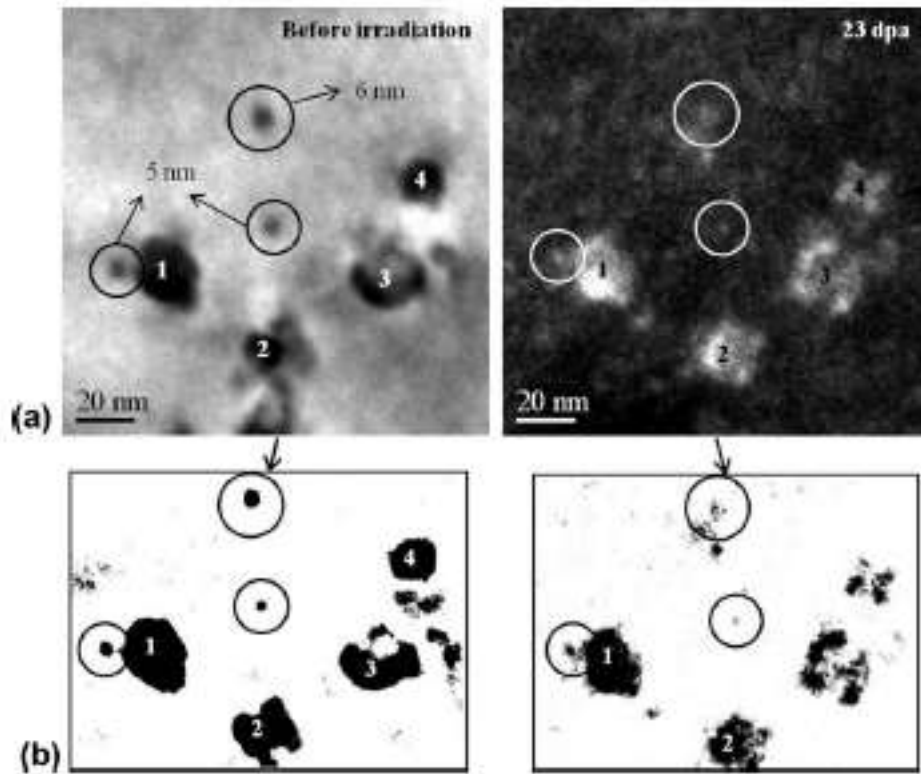

Fig. 1. Depth profiles of displacement damages in Fe calculated by SRIM.

Radiation stability of nano-oxides in ODS steels

Example 1: M.-L. Lescoat, J. Ribis, Y. de Carlan et al.

In situ TEM at JANNuS-Orsay

■ Nano particle evolution

~45 dpa

Fe⁺ 150 keV, 500°C
 ϕ 3.7 10¹² ion.cm⁻².s⁻¹
 Φ_{max} 1.6 10¹⁶ ion.cm⁻².s⁻¹
 (~45 dpa)

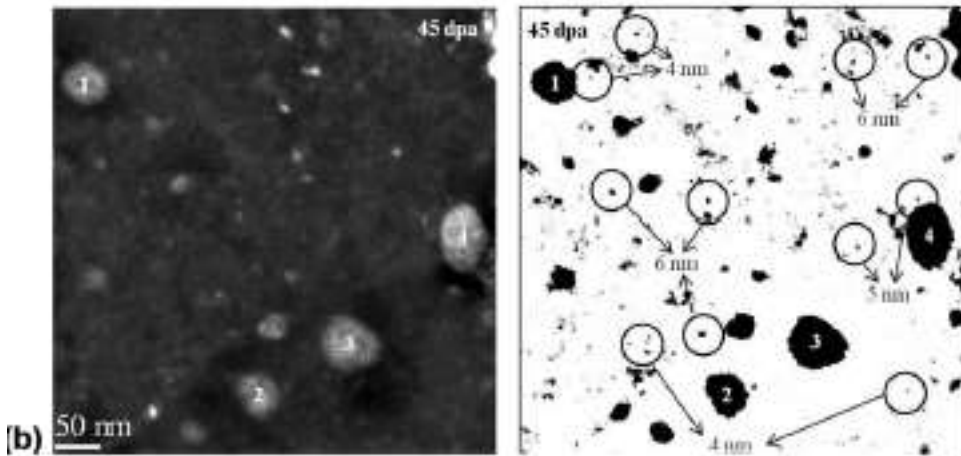
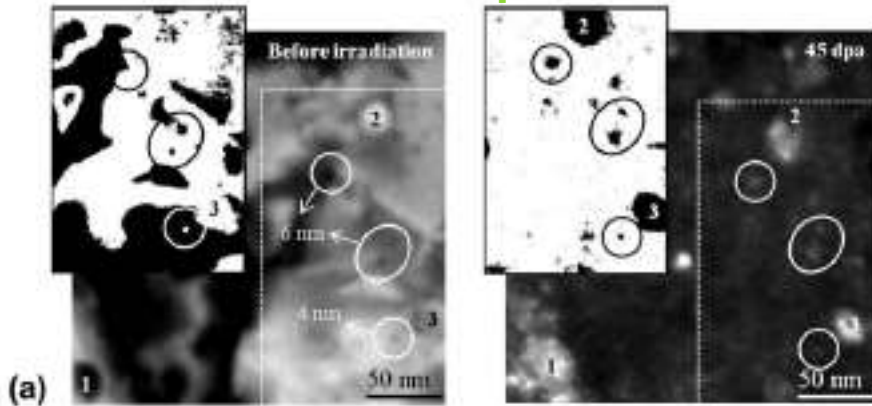

Nanoparticles are still visible after irradiation at ~45 dpa

Radiation stability of nano-oxides in ODS steels

Example 1: M.-L. Lescoat, J. Ribis, Y. de Carlan et al.

High dose irradiation at JANNUS-Saclay

■ Nanoparticle study

Fe^+ 0.5 MeV, 500°C
 ϕ $2.7 \cdot 10^{12} \text{ ion.cm}^{-2}.\text{s}^{-1}$
 Φ_{max} $8.9 \cdot 10^{16} \text{ ion.cm}^{-2}.\text{s}^{-1}$
 (~220 dpa)

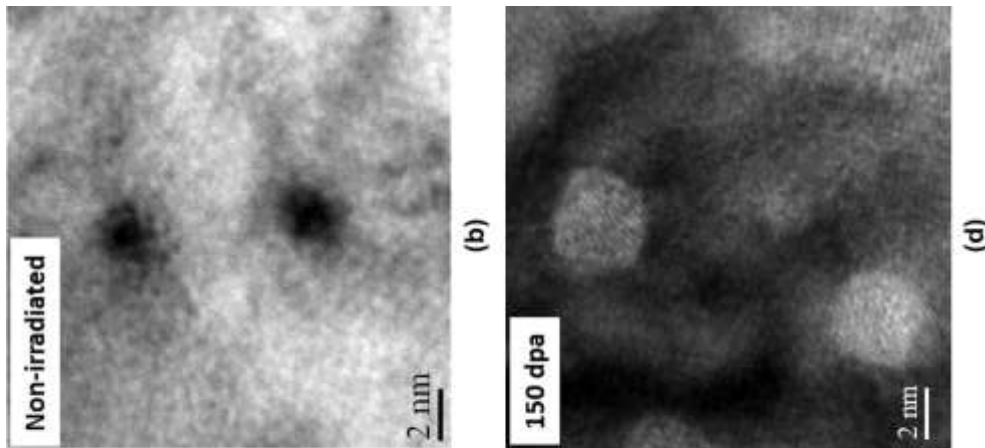

Nanoparticles are still dispersed after irradiation at high dose

FFT and HRTEM

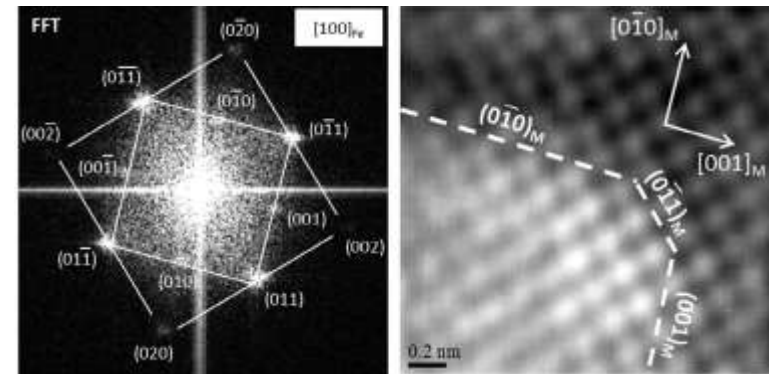

3-D APT chemical reconstruction

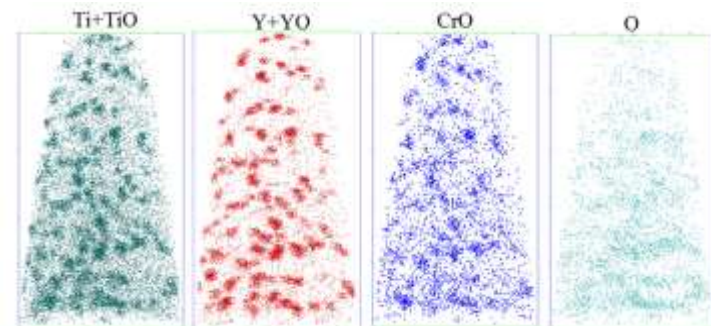

Radiation stability of nano-oxides in ODS steels

Example 1: M.-L. Lescoat, J. Ribis, Y. de Carlan et al.

High dose irradiation at JANNuS-Saclay

Nanoparticle study

Statistics on nanoparticles distribution and size

Fe^+ 0.5 MeV, 500°C
 ϕ $2.7 \cdot 10^{12} \text{ ion.cm}^{-2}.\text{s}^{-1}$
 Φ_{max} $8.9 \cdot 10^{16} \text{ ion.cm}^{-2}.\text{s}^{-1}$
 (~220 dpa)

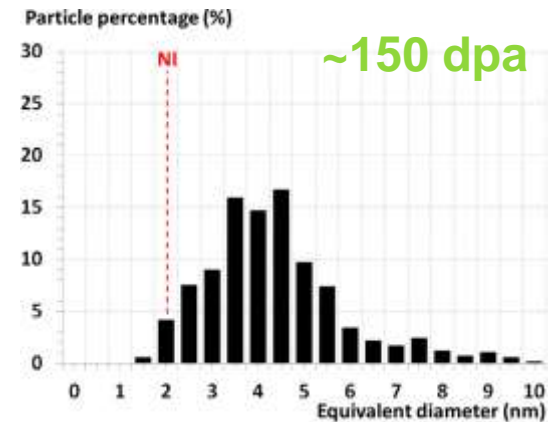
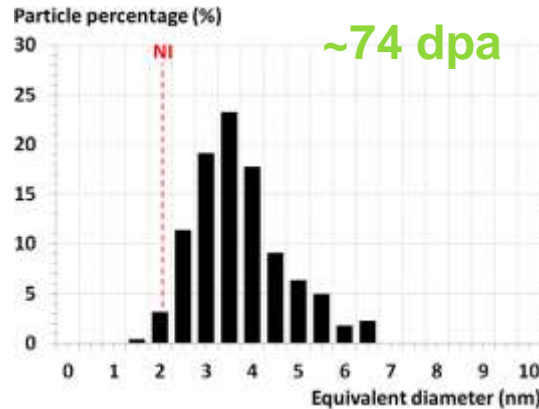
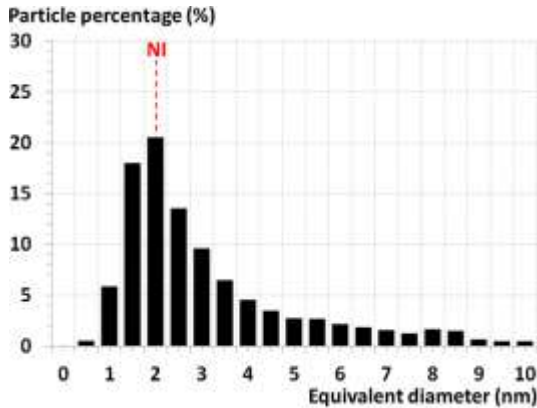

Size increases and density decreases with increasing dose consistent with a Oswald ripening process

Evolution of extended defects in UO_2 under irradiation

Example 2: C. Onofri, C. Sabathier, M. Legros et al.

In situ TEM at JANNuS-Orsay

390 keV Xe at $-180\text{ }^\circ\text{C}$

0.06

0.18

0.6

1.8

Damage (dpa)

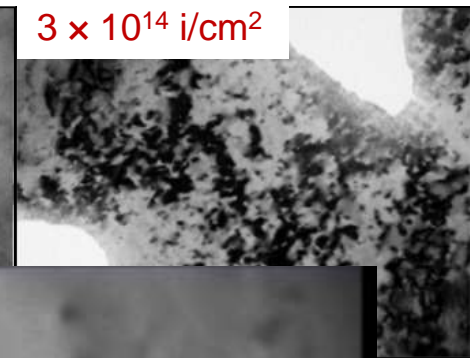
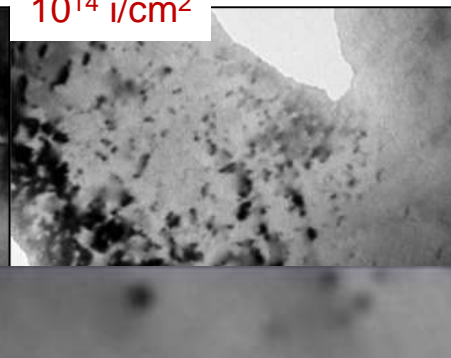
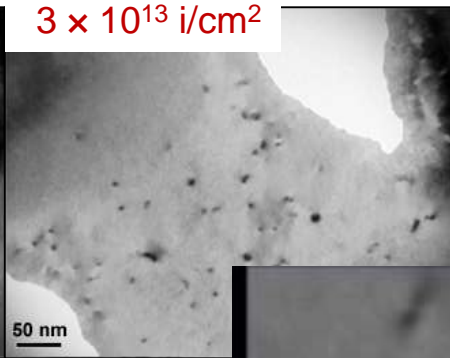
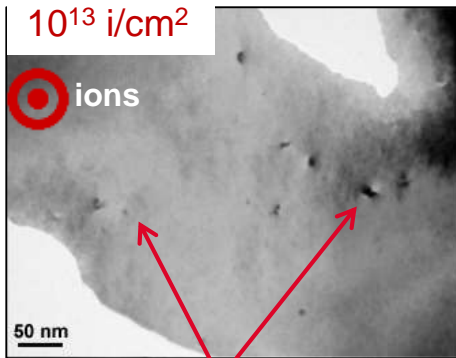

Defect clusters \rightarrow Future dislocation loops

Small loops

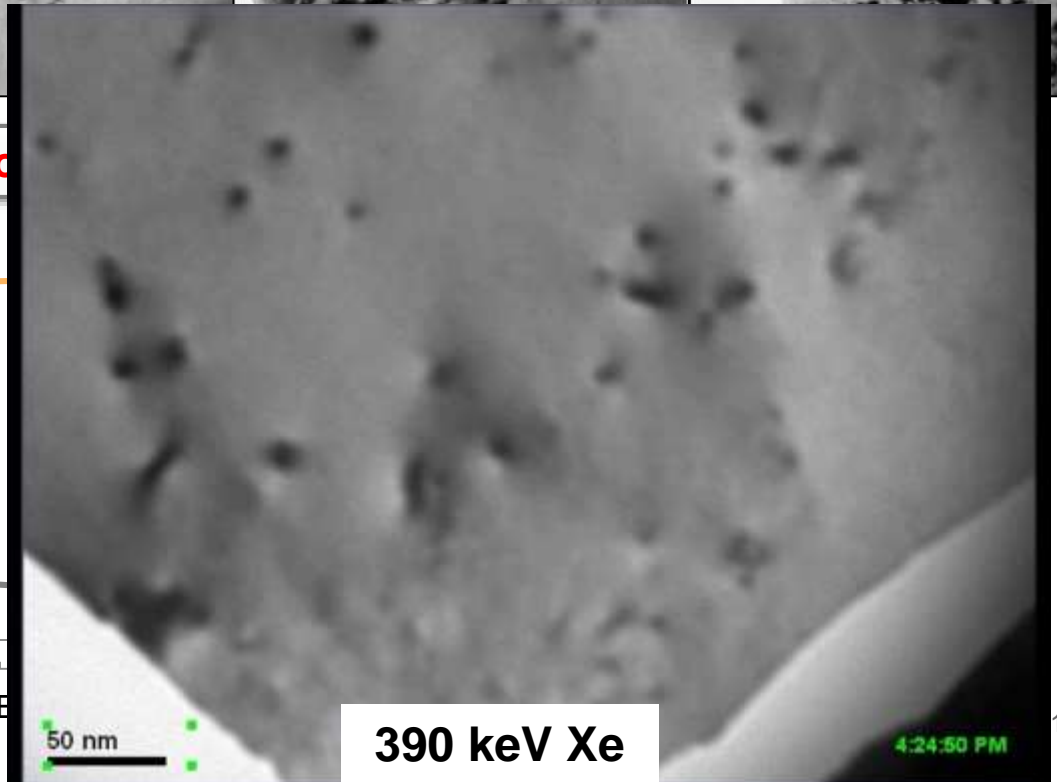
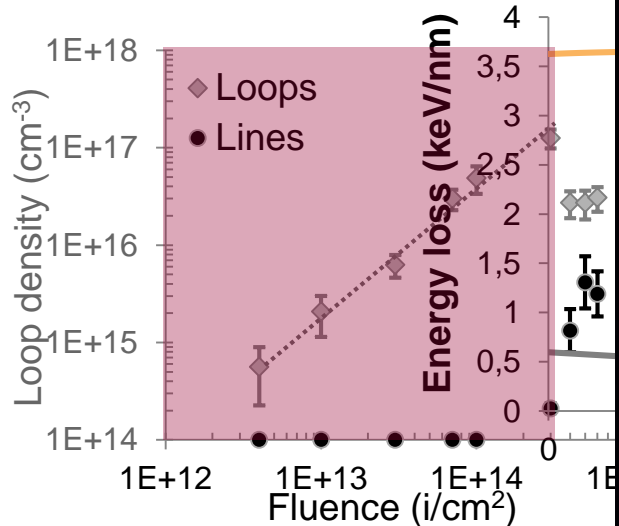

Evolution of extended defects in UO_2 under irradiation

Example 2: C. Onofri, C. Sabathier, M. Legros et al.

In situ TEM at JANNUS-Orsay

390 keV Xe at -180°C

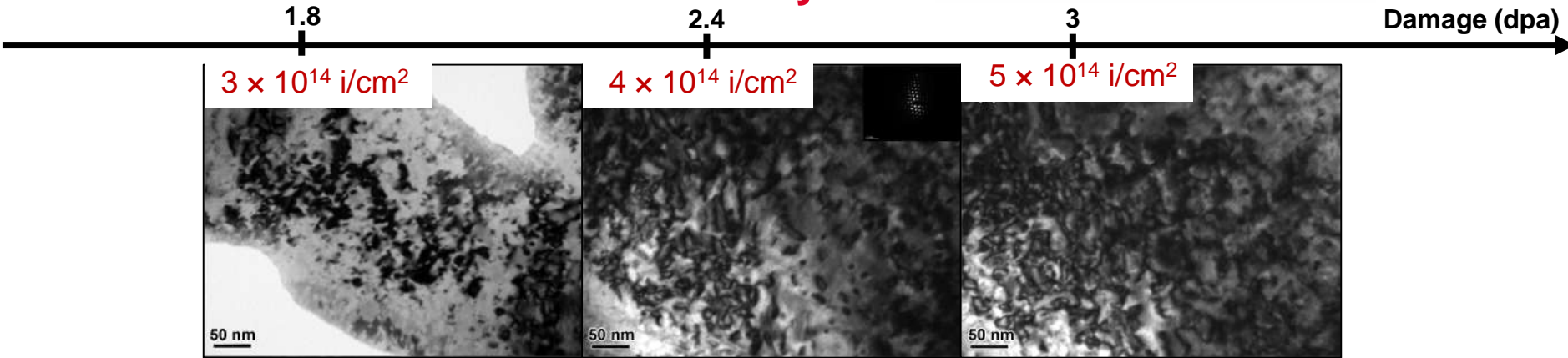

Loops overlapping for geometric reasons
 → Transformation into lines

Steady state equilibrium
 → Lines and small loops (< 10 nm)

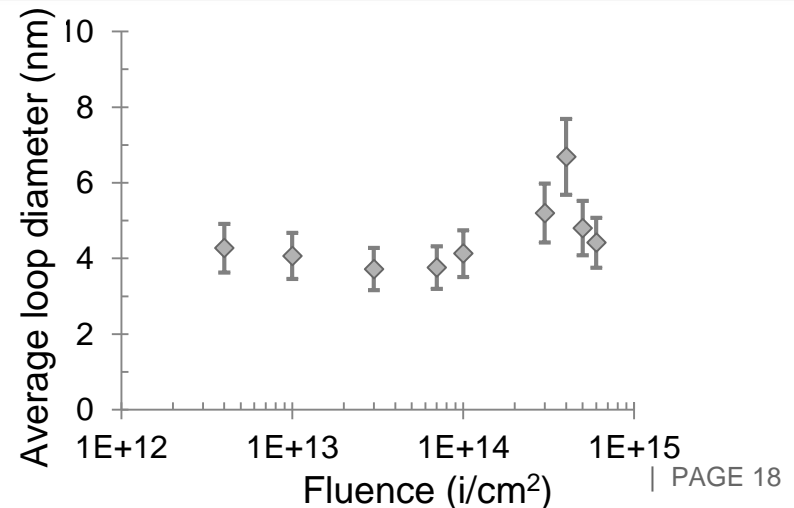
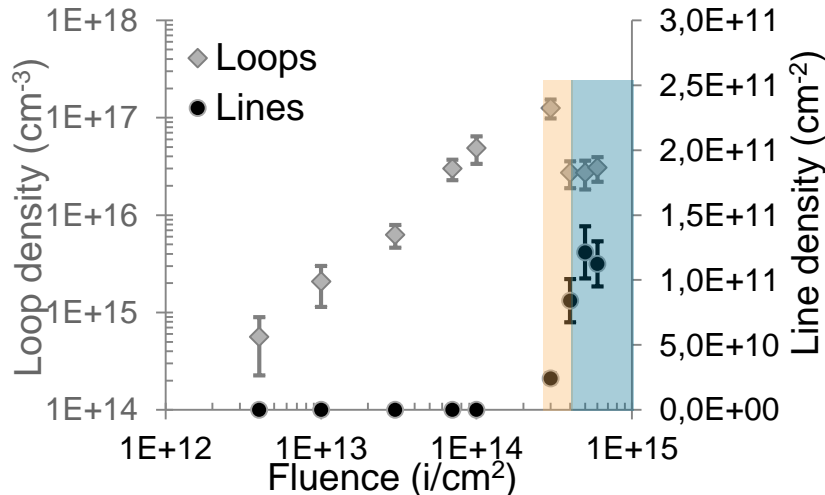

Evolution of extended defects in UO_2 under irradiation

Example 2: C. Onofri, C. Sabathier, M. Legros et al.



4 MeV Kr at -160°C

In situ Raman at JANNUS-Saclay

Defects band

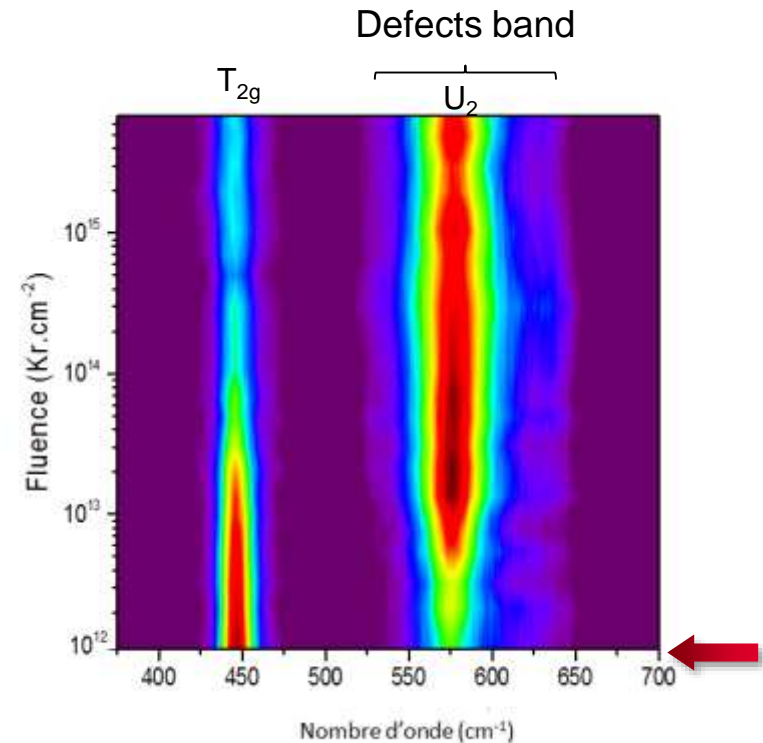
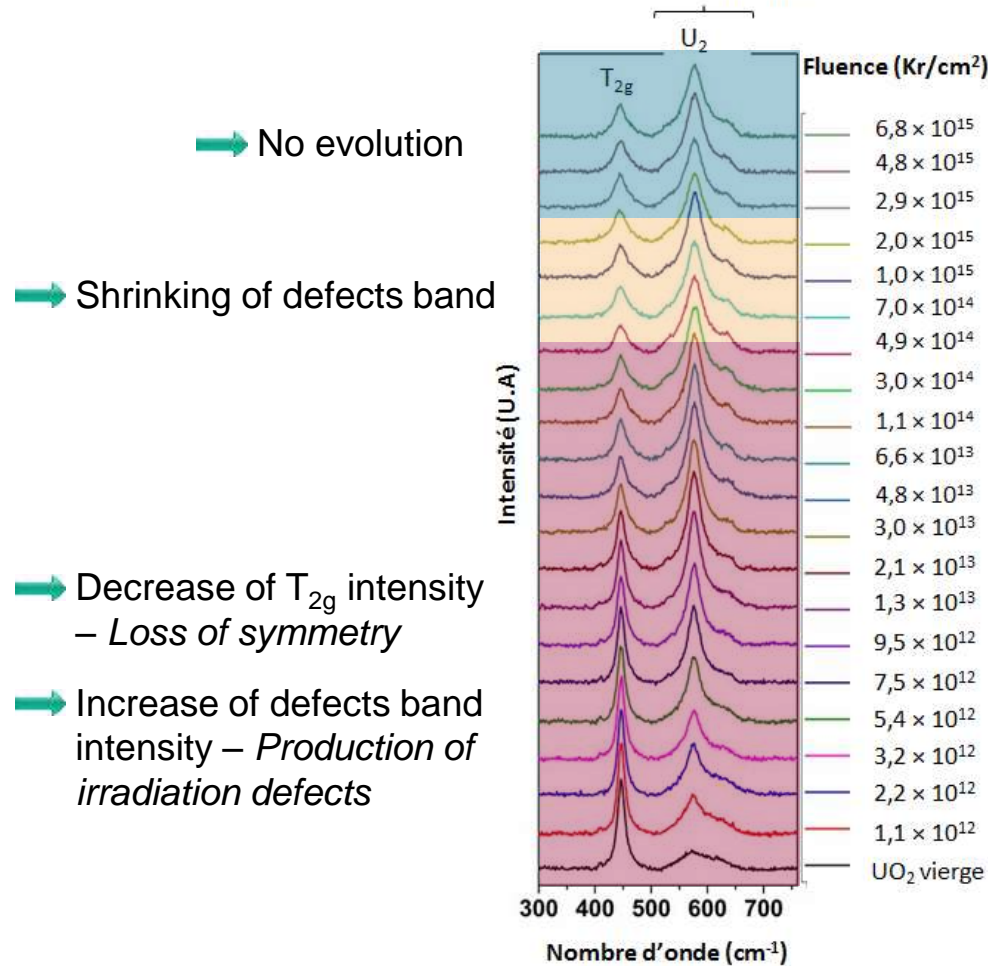

Evolution of extended defects in UO_2 under irradiation

Example 2: C. Onofri, C. Sabathier, M. Legros et al.

Good correlation between Raman and TEM characterizations
Extended defects could contribute to the defects band

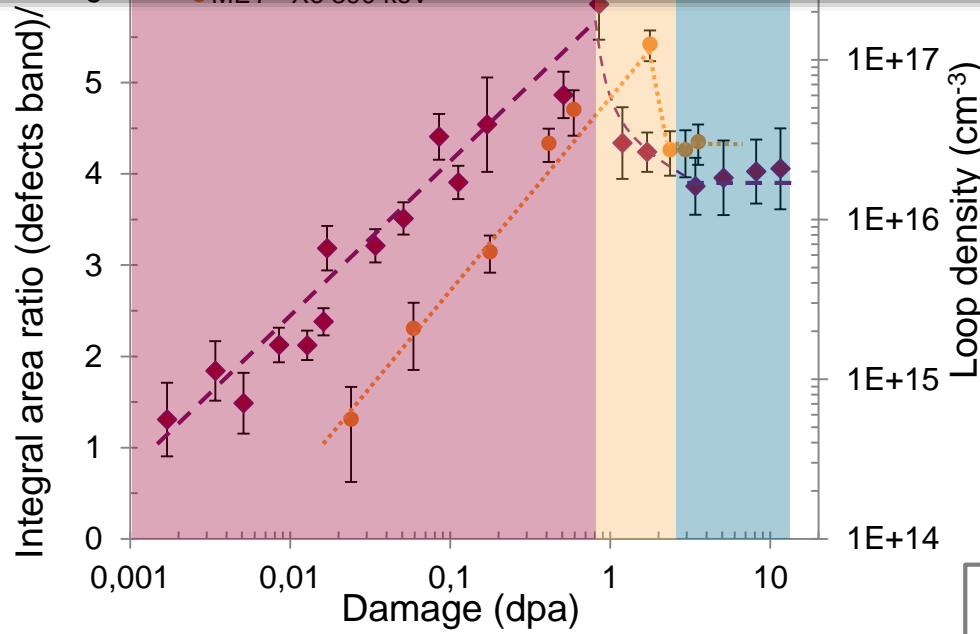

C. Onofri et al., EMIRUM2016, 20-21/10/16, Saclay, France

Small loops nucleation stage (< 10 nm)

Loops transformation into lines by overlapping

Steady state equilibrium : Lines and continuous nucleation of small loops (< 10 nm)

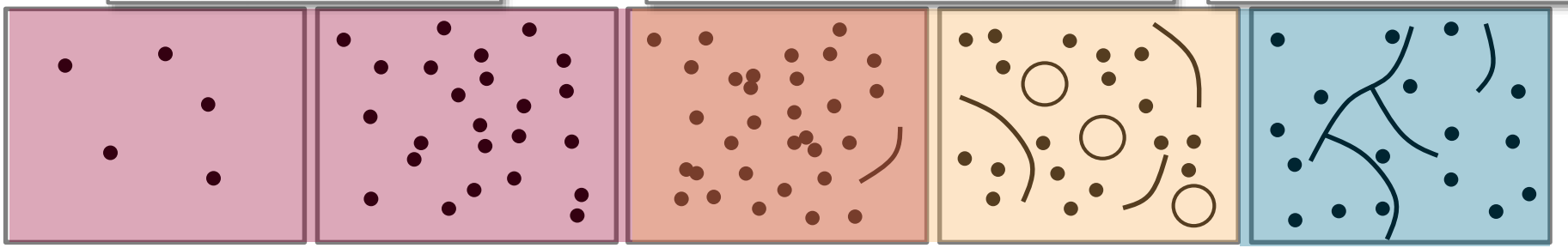

Radiation stability of a Cr-coating/Zr-alloy interface

Example 3: A. Wu, J. Ribis, J.C. Brachet et al.

High energy irradiation at JANNUS-Saclay

Chemical evolution at the interface (EDS)

Kr^{8+} 20 MeV, 400°C
 ϕ $2.8 \cdot 10^{11}$ ion.cm⁻².s⁻¹
 Φ_{max} $6 \cdot 10^{15}$ ion.cm⁻².s⁻¹
 (~10-12 dpa at interface)

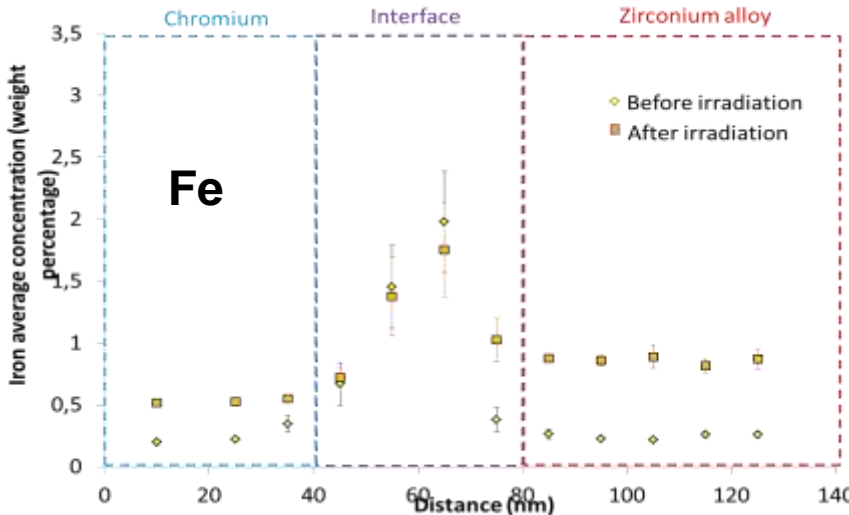
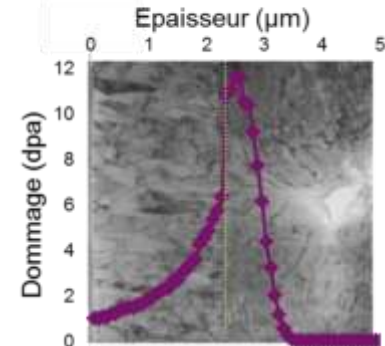
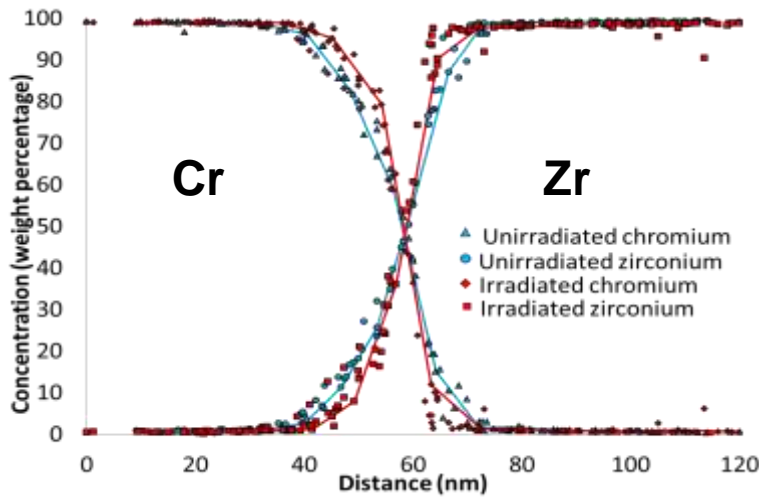

- ✓ No Zr and Cr interdiffusion at ~10 dpa
- ✓ Slight Fe diffusion toward the interface

Radiation stability of a Cr-coating/Zr-alloy interface

Example 3: A. Wu, J. Ribis, J.C. Brachet et al.

High energy irradiation at JANNuS-Saclay

■ Structural evolution at the interface (HR-TEM)

Kr^{8+} 20 MeV, 400°C
 ϕ $2.8 \cdot 10^{11}$ ion.cm⁻².s⁻¹
 Φ_{max} $6 \cdot 10^{15}$ ion.cm⁻².s⁻¹
 (~10-12 dpa at interface)

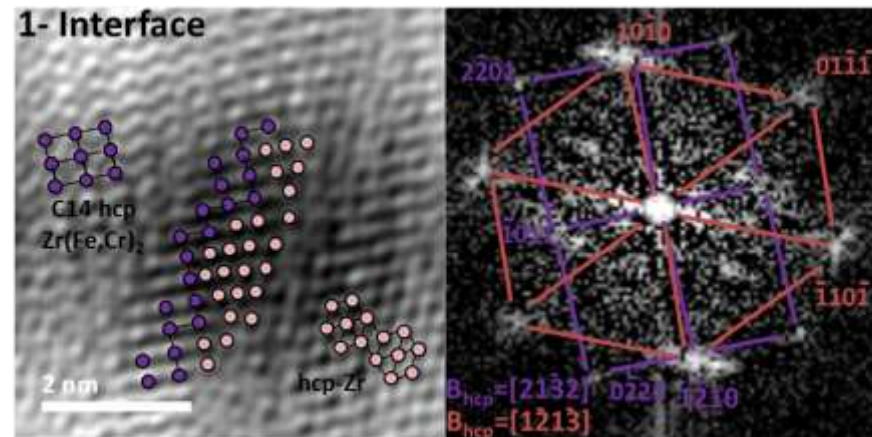
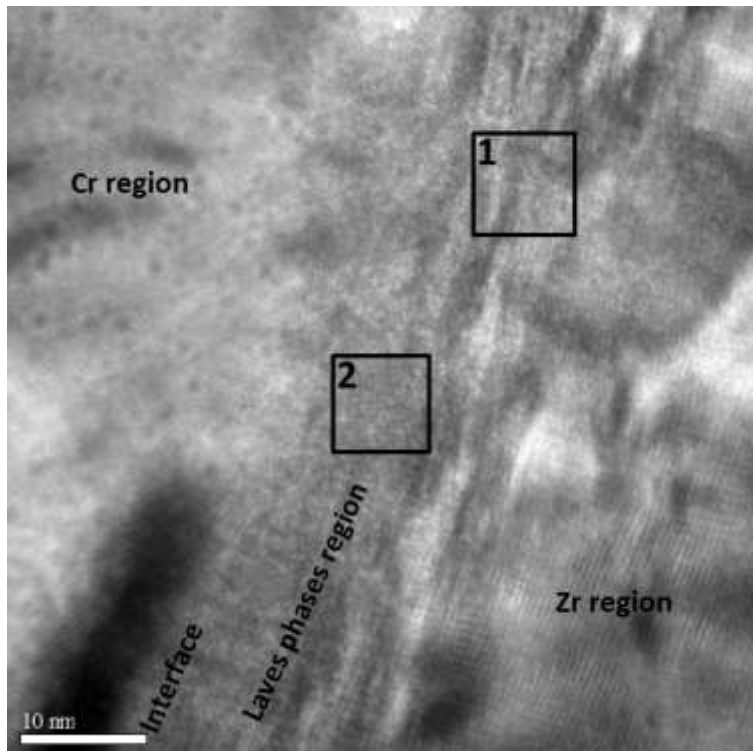

- ✓ interface still crystalline and coherent at ~10 dpa
- ✓ Only the Laves phase C14 remains (no more the C15)

Radiation stability of a Cr-coating/Zr-alloy interface

Example 3: A. Wu, J. Ribis, J.C. Brachet et al.

Interface evolution with in situ TEM

Au^{2+} 4 MeV, 400°C
 ϕ $2.8 \cdot 10^{11}$ ion.cm⁻².s⁻¹
 Φ_{max} $4,8 \cdot 10^{15}$ ion.cm⁻².s⁻¹
 (~21dpa in Cr, ~36dpa in Zr)

■ EDS and EF-TEM

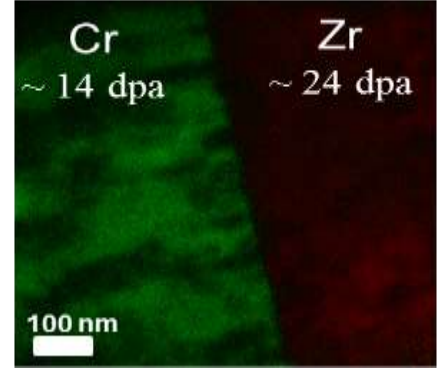
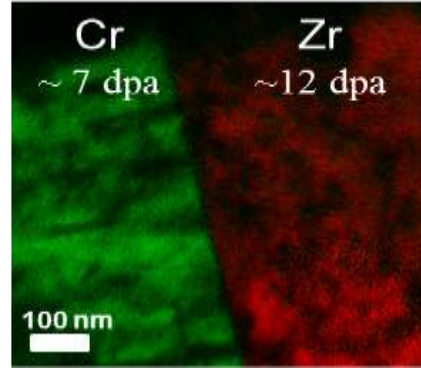
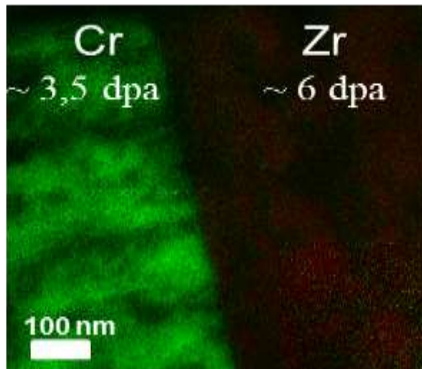
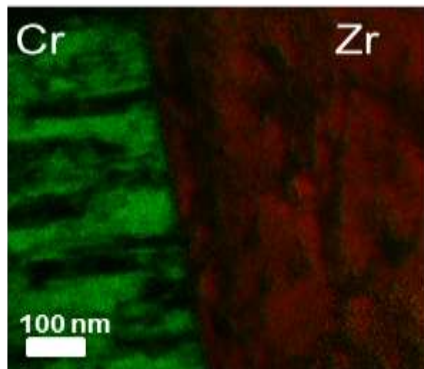
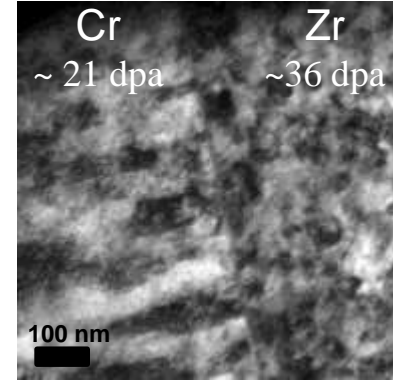
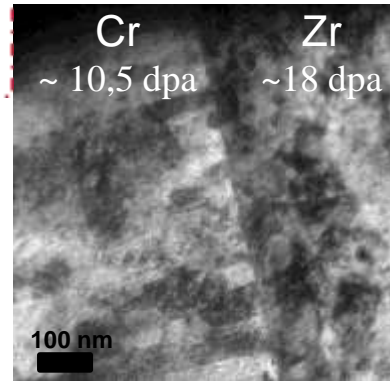
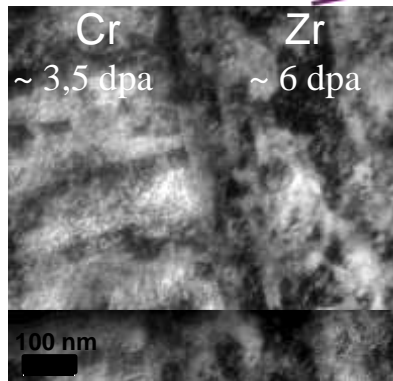
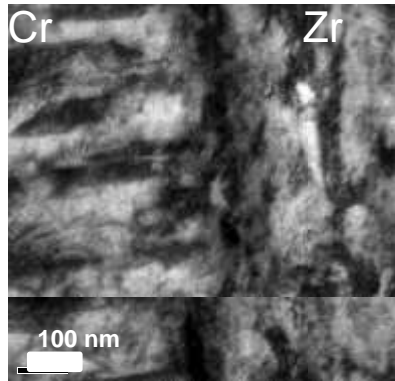
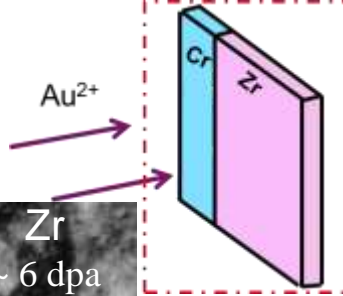

- ✓ Defects density increases but the interface remains well visible
- ✓ Chemical stability with increasing irradiation dose

A. Wu et al., EMIRUM2016, 20-21/10/16, Saclay, France

Radiation stability of a Cr-coating/Zr-alloy interface

Example 3: A. Wu, J. Ribis, J.C. Brachet et al.

In situ examination of the interface

Au^{2+} 4 MeV, 400°C
 ϕ $2.8 \cdot 10^{11}$ ion.cm⁻².s⁻¹
 Φ_{max} $4,8 \cdot 10^{15}$ ion.cm⁻².s⁻¹
 (~21dpa in Cr, ~36dpa in Zr)

EDS up to 24dpa

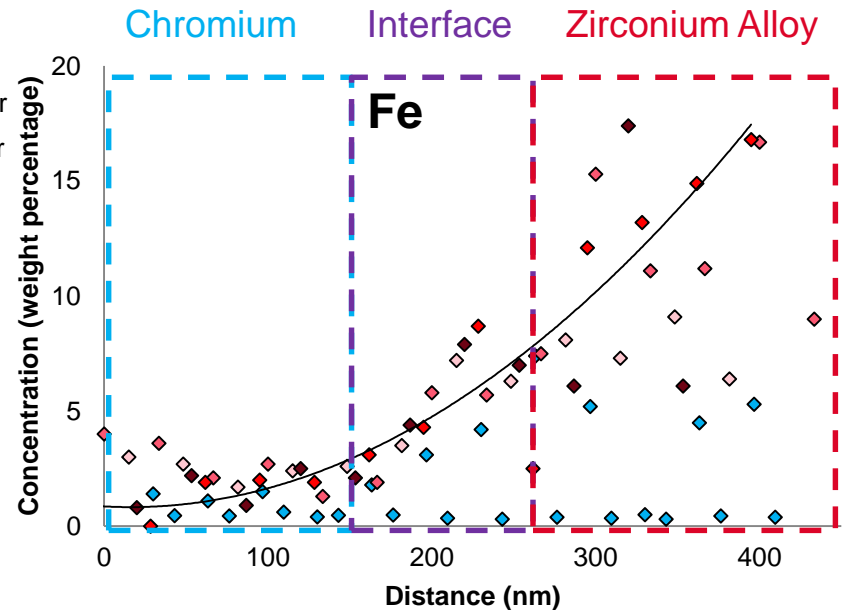
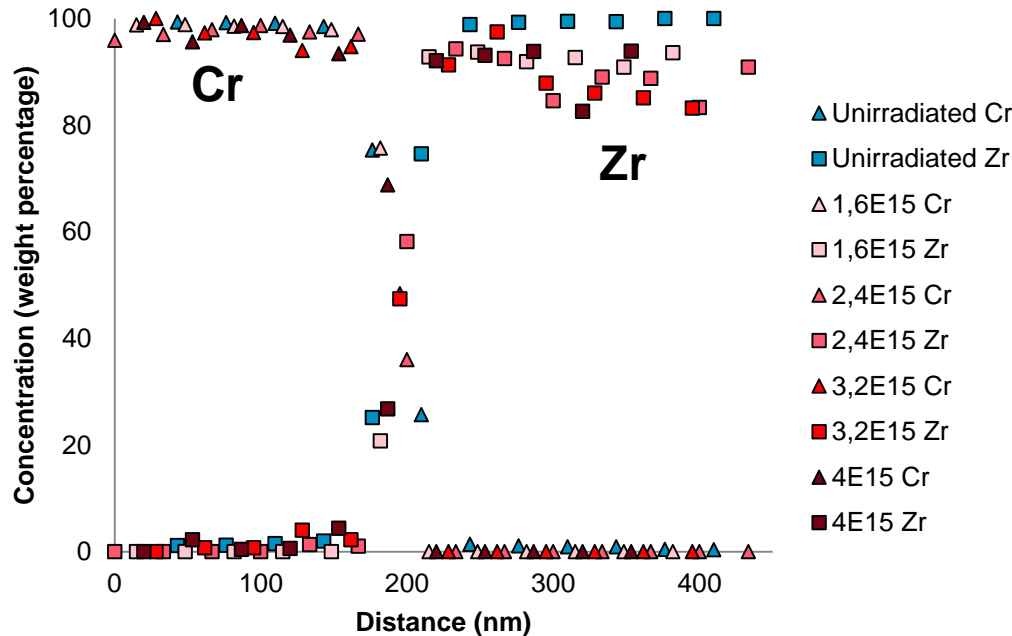

- ✓ Chemical profile Zr/Cr remains stable
- ✓ Fe diffusion toward interface increases with dose

JANNUS: two complementary facilities

- JANNUS = 5 coupled accelerators for cutting-edge researches on irradiation resistance of innovative materials
 - JANNUS-Orsay = dual ion beam with in situ TEM
 - JANNUS-Saclay = triple ion beam and high dose rate under the auspices of the new Université Paris-Saclay
- Among many studies, examples detailed in this presentation address
 - Radiation stability of nano-oxides in ODS steels for advanced reactors
 - Extended defects build-up in fuel under irradiation
 - Interface stability of a protective coating under irradiation
- National and international beam time access
 - EMIR: French accelerator network for Materials Study under Irradiation
call for proposal 2018 has been issued with deadline on October 21st, visit <http://emir.in2p3.fr/>
projects are evaluated by a Scientific Committee
a financial contribution with reduced fee for EMIR accepted proposals is requested
 - European projects in the frame of H2020 or Eurofusion
 - With charges upon request

