



HAL
open science

Development of a Dual Alpha-Gamma Camera for Radiological Characterization Applications

C. Mahe, F. Lafont, S. Mitra, J. Venara

► **To cite this version:**

C. Mahe, F. Lafont, S. Mitra, J. Venara. Development of a Dual Alpha-Gamma Camera for Radiological Characterization Applications. IEEE Nuclear Science Symposium and Medical Imaging Conference, Oct 2017, Atlanta, United States. cea-02417320

HAL Id: cea-02417320

<https://cea.hal.science/cea-02417320v1>

Submitted on 18 Dec 2019

HAL is a multi-disciplinary open access archive for the deposit and dissemination of scientific research documents, whether they are published or not. The documents may come from teaching and research institutions in France or abroad, or from public or private research centers.

L'archive ouverte pluridisciplinaire **HAL**, est destinée au dépôt et à la diffusion de documents scientifiques de niveau recherche, publiés ou non, émanant des établissements d'enseignement et de recherche français ou étrangers, des laboratoires publics ou privés.

DE LA RECHERCHE À L'INDUSTRIE



2017 IEEE Nuclear Science Symposium & Medical Imaging Conference

21-28 October 2017, Hyatt Regency, Atlanta, Georgia, USA

Development of a Dual Alpha-Gamma Camera for Radiological Characterization Applications

(NSS) Nuclear instrumentation and Measurement for reactors and related Applications



MAHE Charly, LAFONT Fabien, MITRA Saptarshi, VENARA Julien

www.cea.fr



In Situ measurement laboratory in Marcoule : ~40 years

R&D on Nuclear Instrumentation for decommissioning projects



Technical Support and particular operations for CEA, AREVA, EDF, IAEA, CSK-CEN, ...

- **CEA Centers** : Saclay, Fontenay-Aux-Roses, Marcoule, Cadarache, Grenoble, Valduc, La Hague
- **AREVA Centers** : Marcoule, Cadarache, La Hague
- **EDF Powerplant** : Tricastin, Cruas, Saint-Laurent, Gravelines, Le Blayais, Dampierre, Chinon, Chooz, Cattenom, Flamanville, ...

Part of a laboratory including : virtual reality, robotics (teleoperation) & laser cutting developments

New gamma cameras under development and/or qualification at CEA

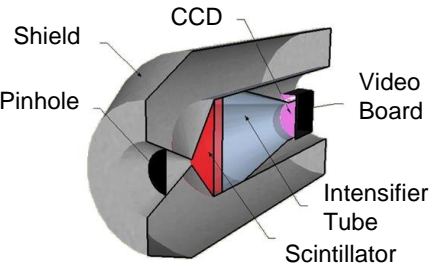
1980

Aladin
Scintillator
Gamma camera

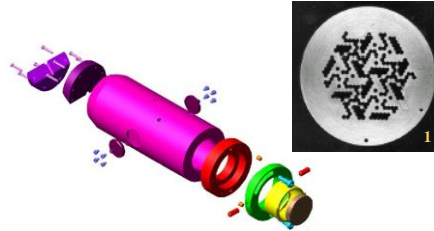

Coded aperture



2000

Additional shutter

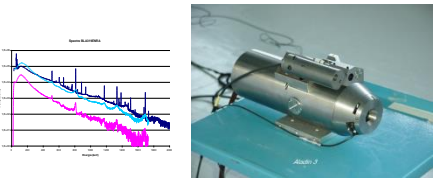

CZT Spectrometry
Dose rate

2012



IPIX™ (CEA/CANBERRA)

Medipix technology, USB
Coded aperture

Better performances
Lower price
More compact & portable device

New gamma cameras under development and/or qualification at CEA

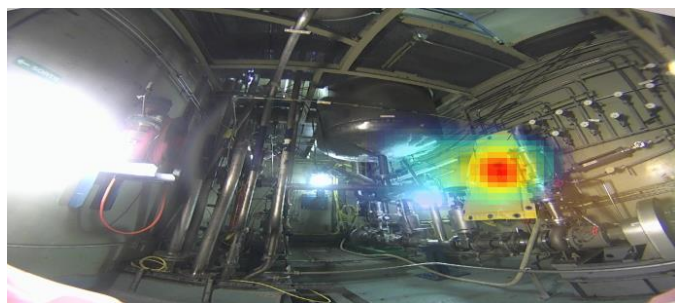
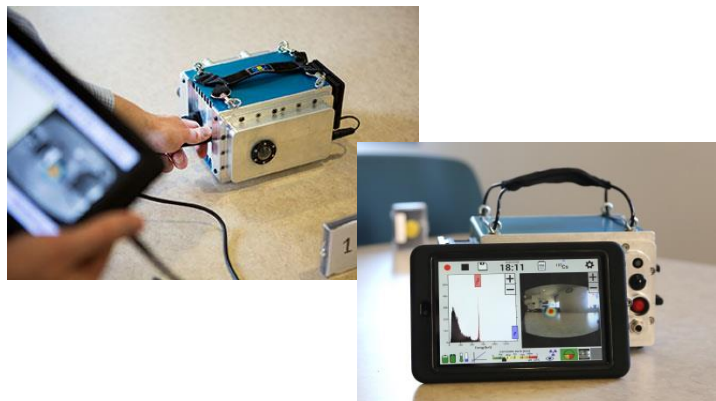

POLARIS (H3D)

CZT Compton camera

Wireless

Gamma spectrum + gamma image
(>250 keV in Compton Mode)



IPIX™ (CEA/MIRION)

Medipix
technology, USB



Coded aperture

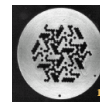

Better performances

Lower price

More compact & portable device

**Next
generation**

?

CZT/Coded Aperture

+

Compton Camera

+

Spectrometric function
at any Energy range

Partnership under progress

CEA/DRT, CEA/IRFU, CEA/DEN

MIRION, GIE INTRA, IRSN, 3D
PLUS

Used with 3D view

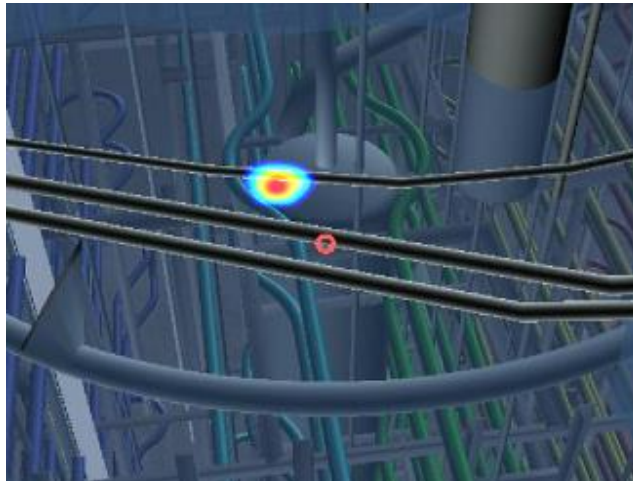

Hot spots
localization

Used with *real* view



Extended
spots
localization

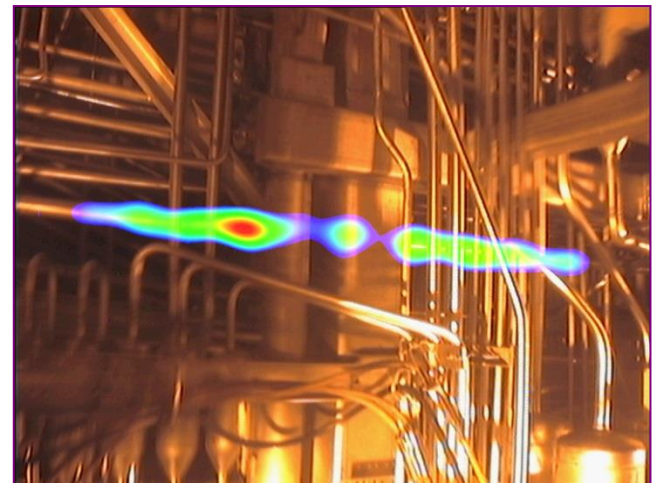
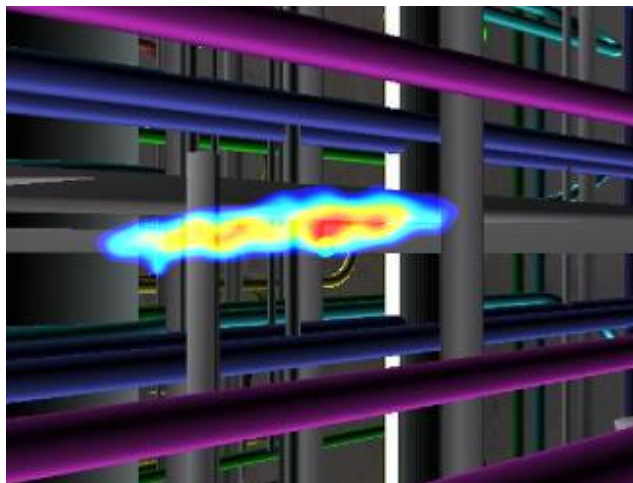

ALPHA CAMERA : A RECENT CAMERA TO LOCALIZE ALPHA CONTAMINATION

Detection of the UV produced by nitrogen molecules under an alpha particle desintegration

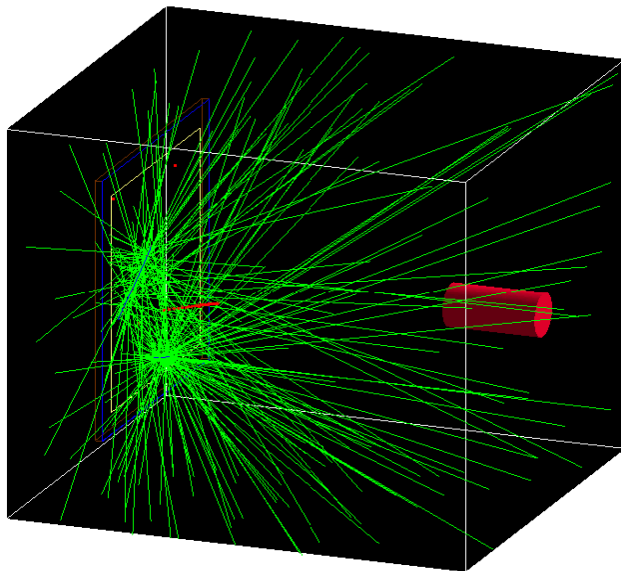

GEANT4 Model of a ^{241}Am source

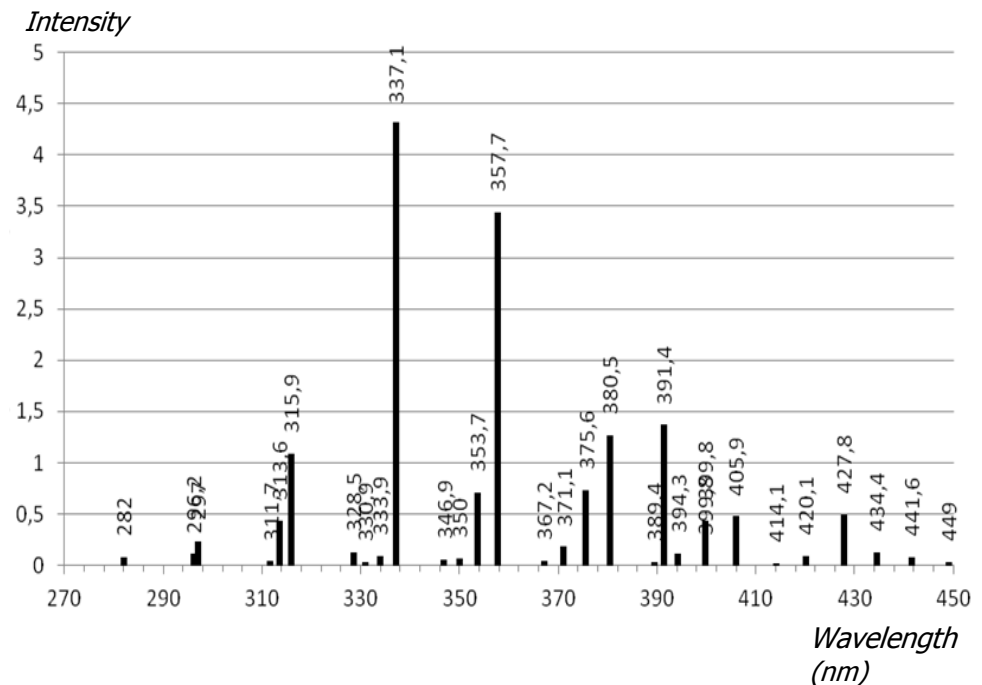

Radio-luminescence of Nitrogen phenomena

ALPHA CAMERA : A RECENT CAMERA TO LOCALIZE ALPHA CONTAMINATION

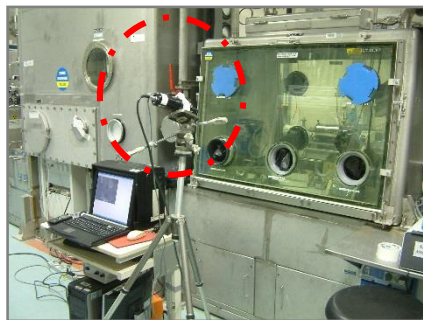

Raw α image

Atalante plant (2009)



Results after processing
(threshold,
colour rendering,
superimposition)



- Localisation of α hot spots
- Radionucléides : U / ^{241}Am / Pu
- Quick acquisition times (< 15 minutes)

- Measurements at distance,
trough Triplex (1,3 cm)
& Leaded glass (1,5 cm à 6 cm)

Raw image (without light)



Visible B&W image (with light)



Raw image processed and superimposed on the B&W image

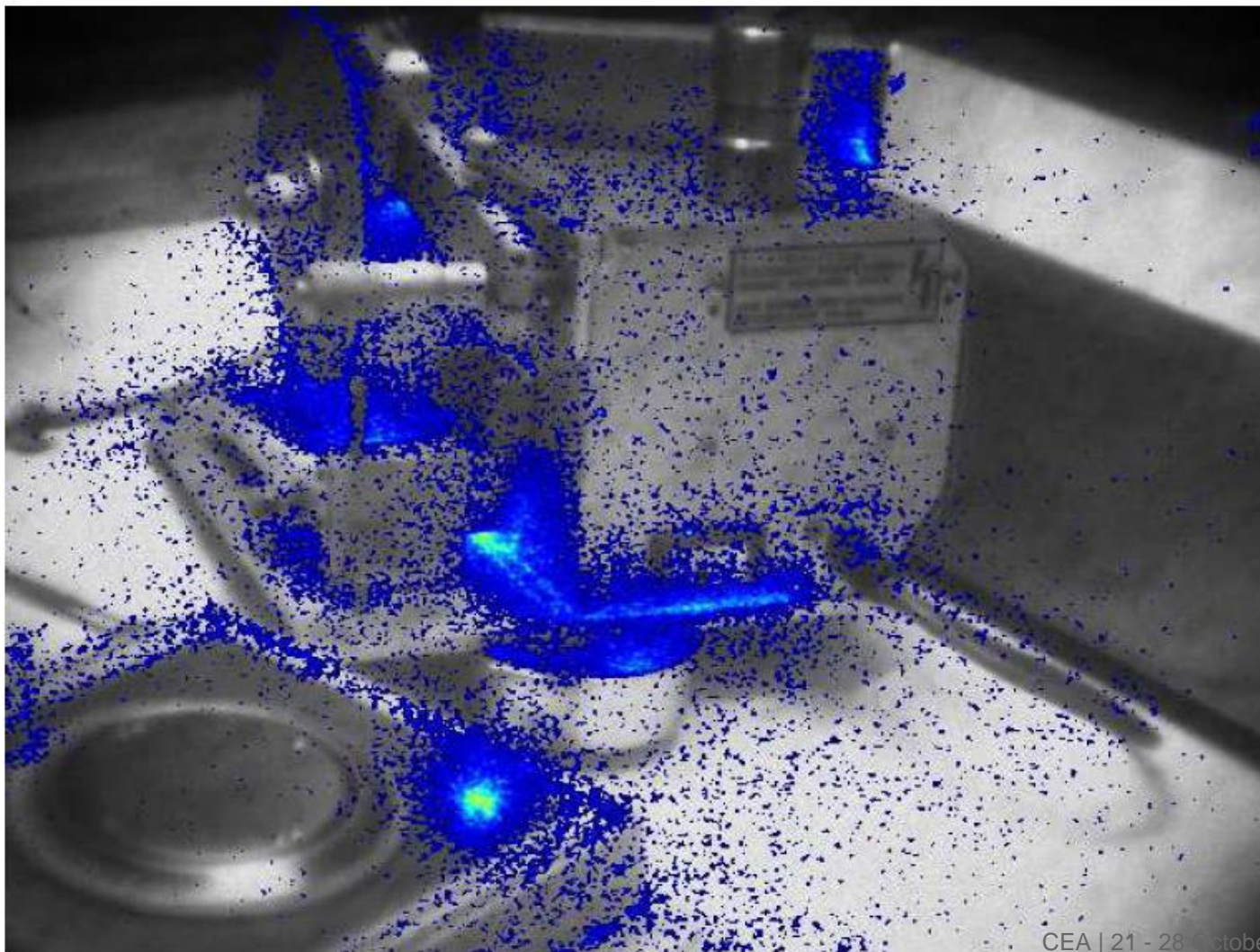

Raw image processed and superimposed on the colour image

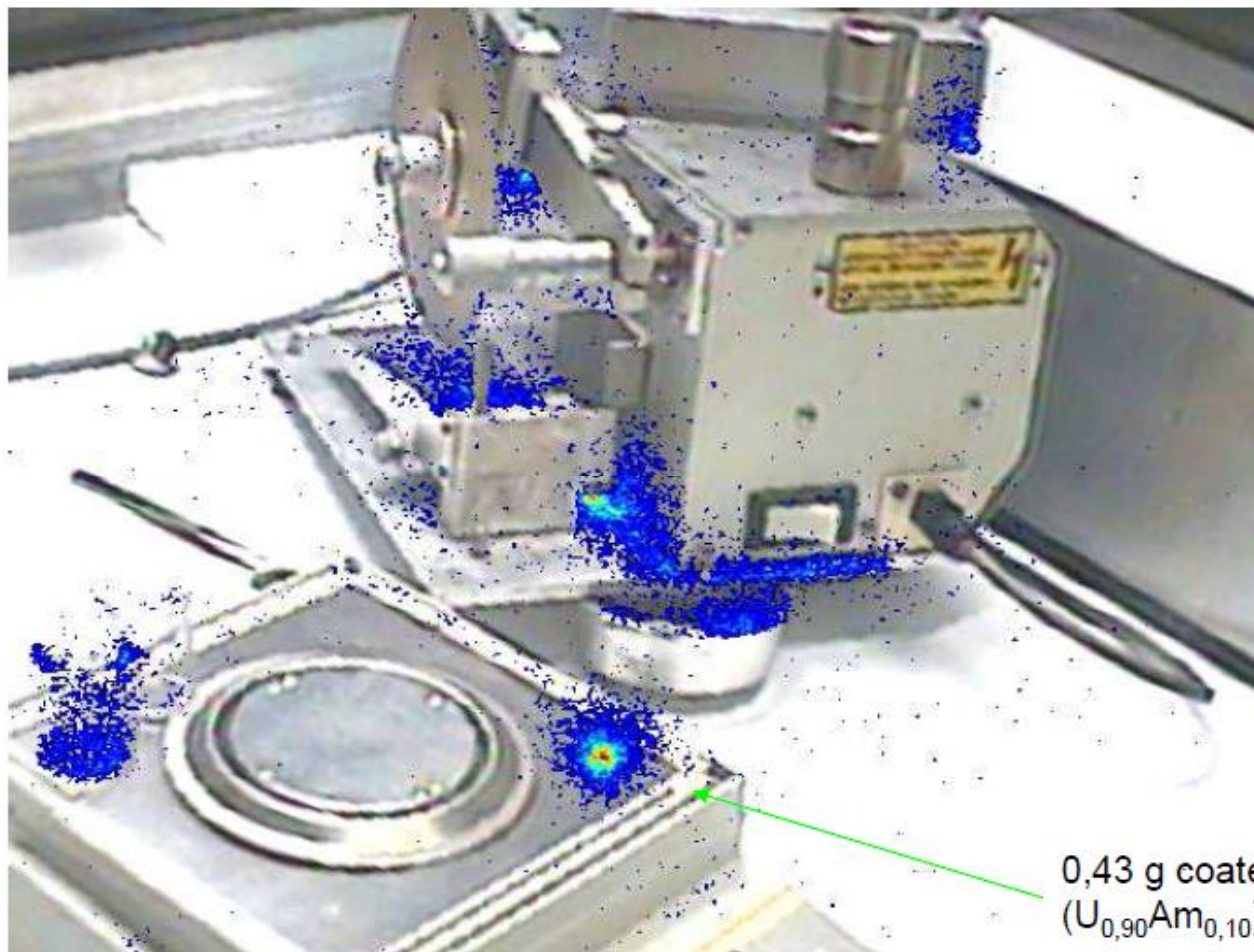

0,43 g coated tablet
 $(U_{0,90}Am_{0,10})O_{2-x}$

ALPHA CAMERA : A RECENT CAMERA TO LOCALIZE ALPHA CONTAMINATION

Surface Alpha Contamination Mapping in Darkness Conditions

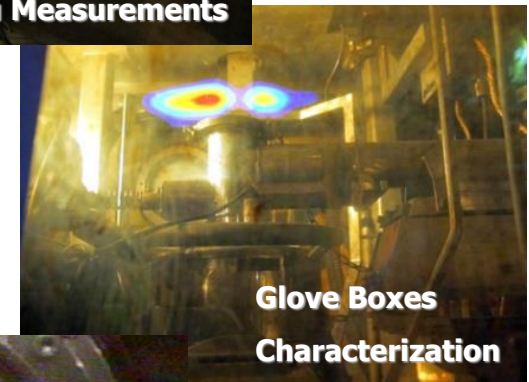
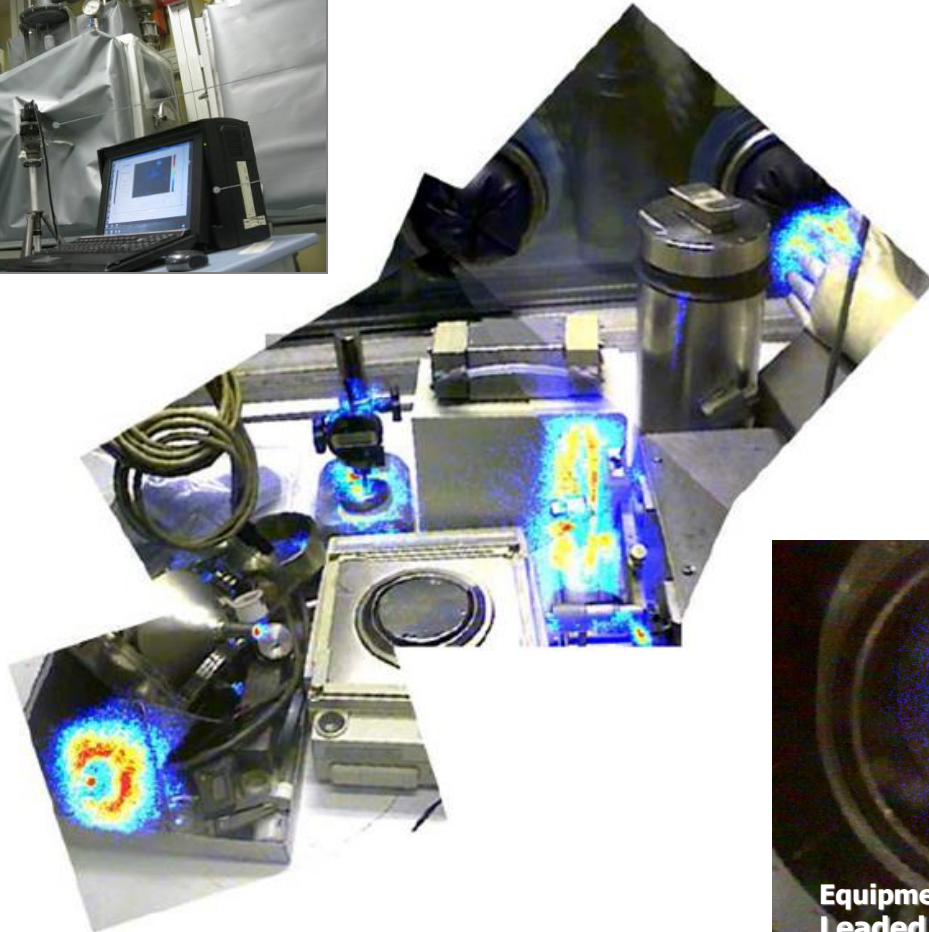

INTEREST OF COUPLING ALPHA AND GAMMA MEASUREMENTS

Example Of A Glove Box Characterization using Alpha Camera and IPIX Gamma Camera, 2016

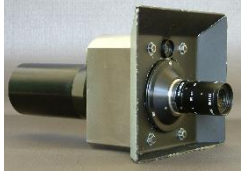

Surface Alpha Contamination

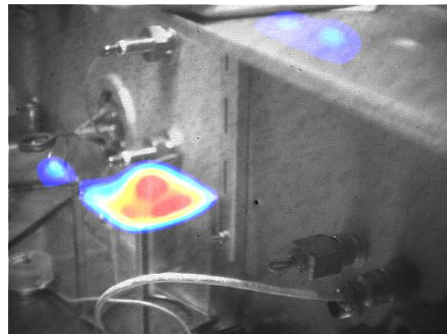
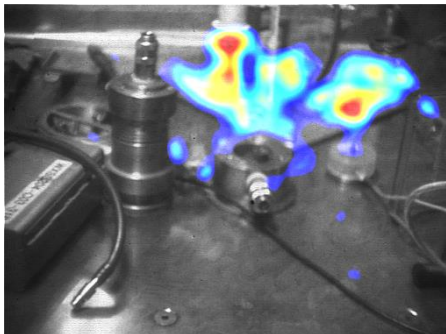
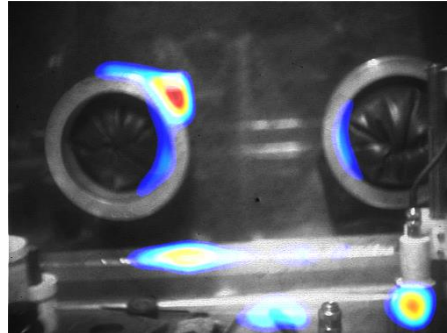
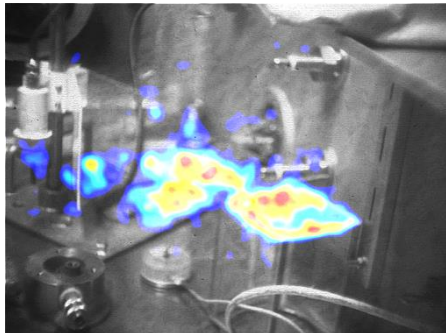

Gamma Main Hot Spot localization
(Dose <math>< 10 \mu\text{Gy}\cdot\text{h}^{-1}</math>)



IPIX™
(CEA/MIRION)

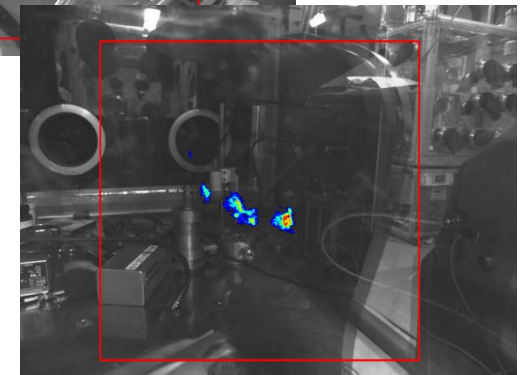

DEVELOPMENT OF A DUAL ALPHA / GAMMA CAMERA

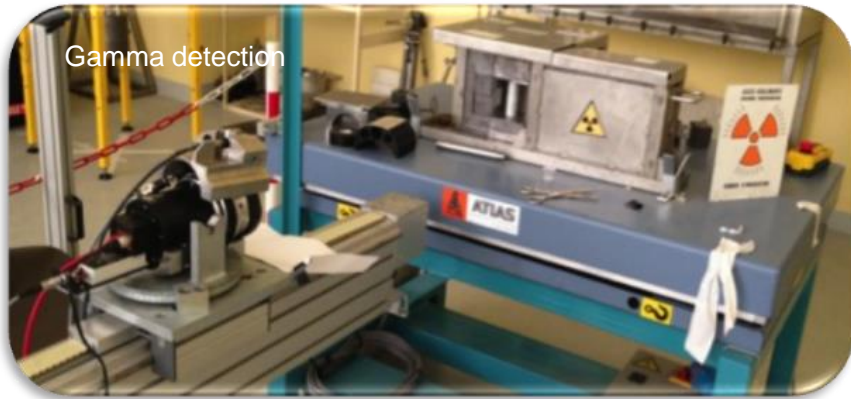

Dual Alpha/Gamma Camera (3rd prototype)

2017

- Still under development and qualification
- Patented still 2015
- Detection of main gamma hot spots

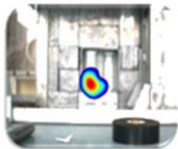

2015

Solar Blind Alpha Camera (2nd prototype)

- Reduced influence of the light
- Good sensitivity to UV for high contaminated area
- Enhanced Connectivity (ethernet)

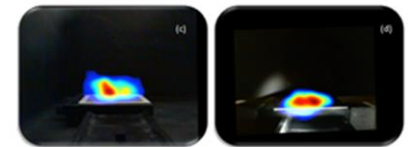

Standard Alpha Camera (1st prototype)

- Darkness condition
- Very good sensitivity to UV

Detection Limit : Act > 100 Bq.cm⁻² (5 min)

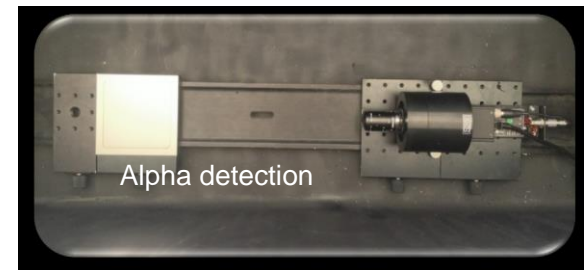

2010

DEVELOPMENT OF A DUAL ALPHA / GAMMA CAMERA

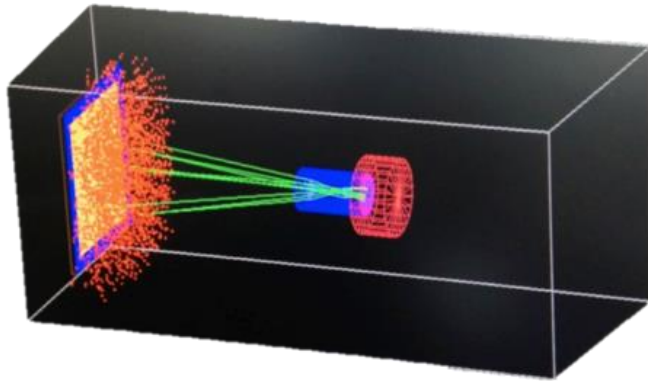

Alpha Camera mode

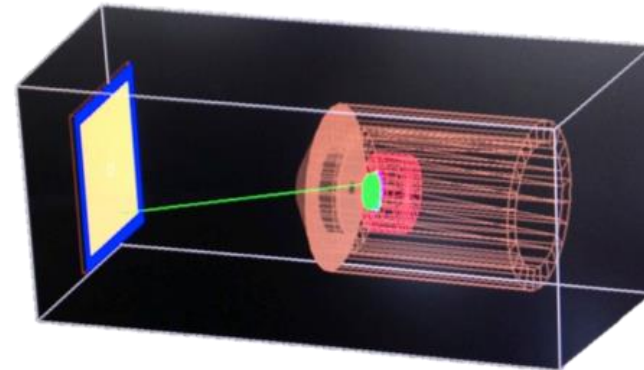

Gamma Camera mode

GEANT 4 Modeling of collection of Scintillation Photons from radio-luminescence through a UV objectif (left) and scintillations photons from gamma->photons conversion using a CsI scintillator and a pinhole collimator (right)

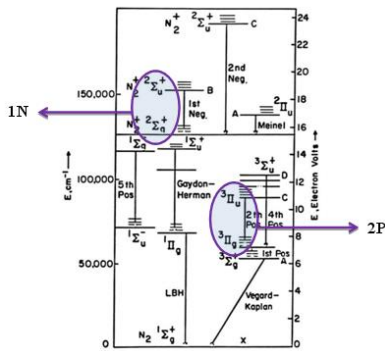

Direct UV integration

Simulated spectrum of photons
(0.913 bars, T= 20°C)

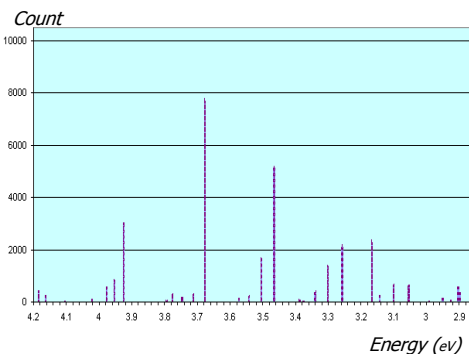

Scintillator	Density (g.cm ⁻³)	λ_{\max} (nm)	Ph/keV _γ
CdWO ₄	7,9	475	12 – 15
Bi ₄ Ge ₃ O ₁₂	7,13	480	8 – 10
Lu _{1,8} Y _{0,2} SiO ₅ :Ce	7,1	420	32
CsI : TI	4,51	550	54
BaF ₂	4,88	310	10

Scintillation photons integration

Use of the AIRFLY (AIR Fluorescence Yield) collaboration [1]

$$Y_{air}(\lambda, p, T, p_h) = Y_{air}(337nm, p_0, T_0, 0) \cdot I(\lambda, p_0, T_0) * \frac{1 + p_0 * (\frac{1}{p'_{air}(\lambda, T_0)} * (1 - \frac{p_h}{p}) + \frac{1}{p'_{H_2O}(\lambda)} * \frac{p_h}{p})}{1 + \frac{p}{(T/T_0)^{\alpha(\lambda)+0,5}} * (\frac{1}{p'_{air}(\lambda, T_0)} * (1 - \frac{p_h}{p}) + \frac{1}{p'_{H_2O}(\lambda)} * \frac{p_h}{p})}$$

Parametric study (température, pression, humidity in air, ...)

Simulation of fluorescence photons spectrum

Geometrical Efficiency

Calibration Factors

Y : Champ de scintillation

I : Intensité relative

p₀ : Pression de référence (1 bar)

T₀ : Température de référence (273°K)

p : Pression de l'environnement

T : Température de l'environnement

p_h : Pression partielle en eau

λ : Longueur d'onde de la raie d'émission

p'_{air} (λ) : paramètre de pression lié à la raie λ

p'_{H₂O} (λ) : paramètre de pression en eau lié à la raie λ

α(λ) : paramètre de température lié à la raie λ

Surface Activity Calibration with S20 photocathode

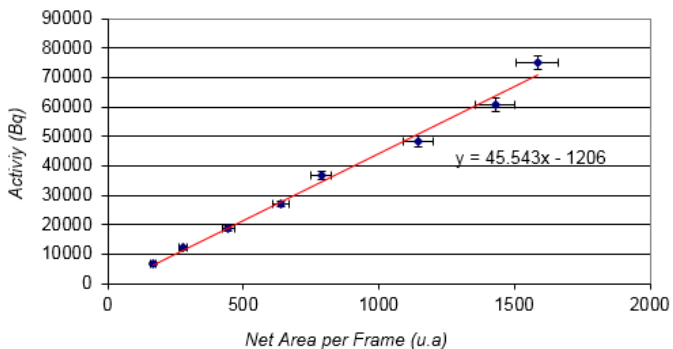

Impact of N₂ Proportion in Air on the fluorescence

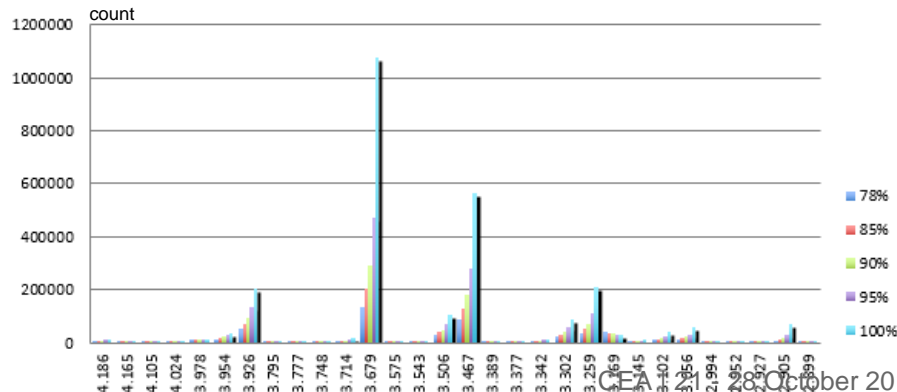

DEVELOPMENT OF A DUAL ALPHA / GAMMA CAMERA

S20

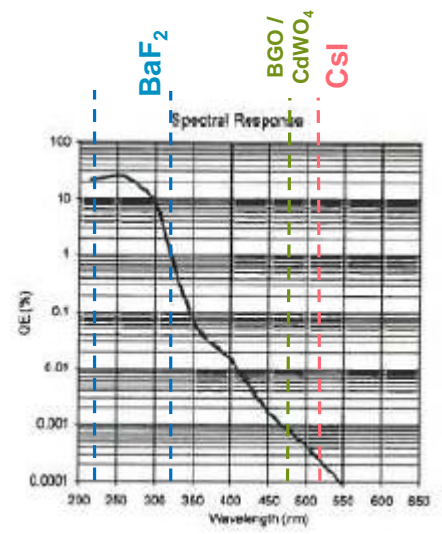
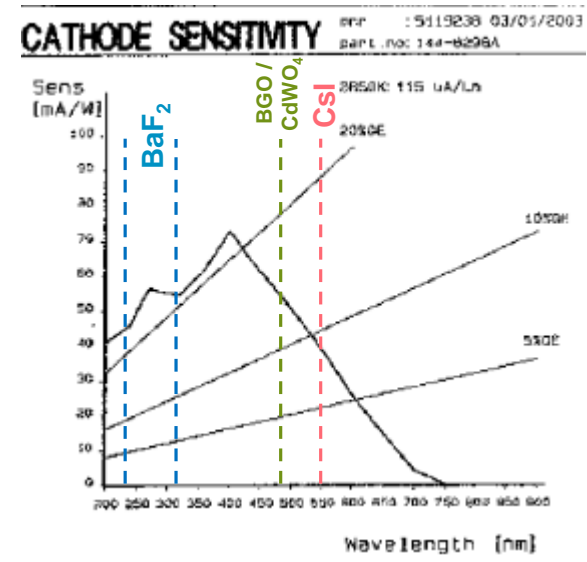

Solar Blind

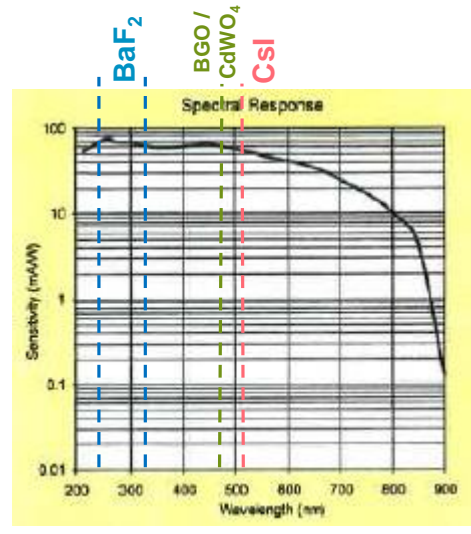

S20 « Low-Noise »

Image Intensifier Tubes Comparison

Alpha / UV Mode

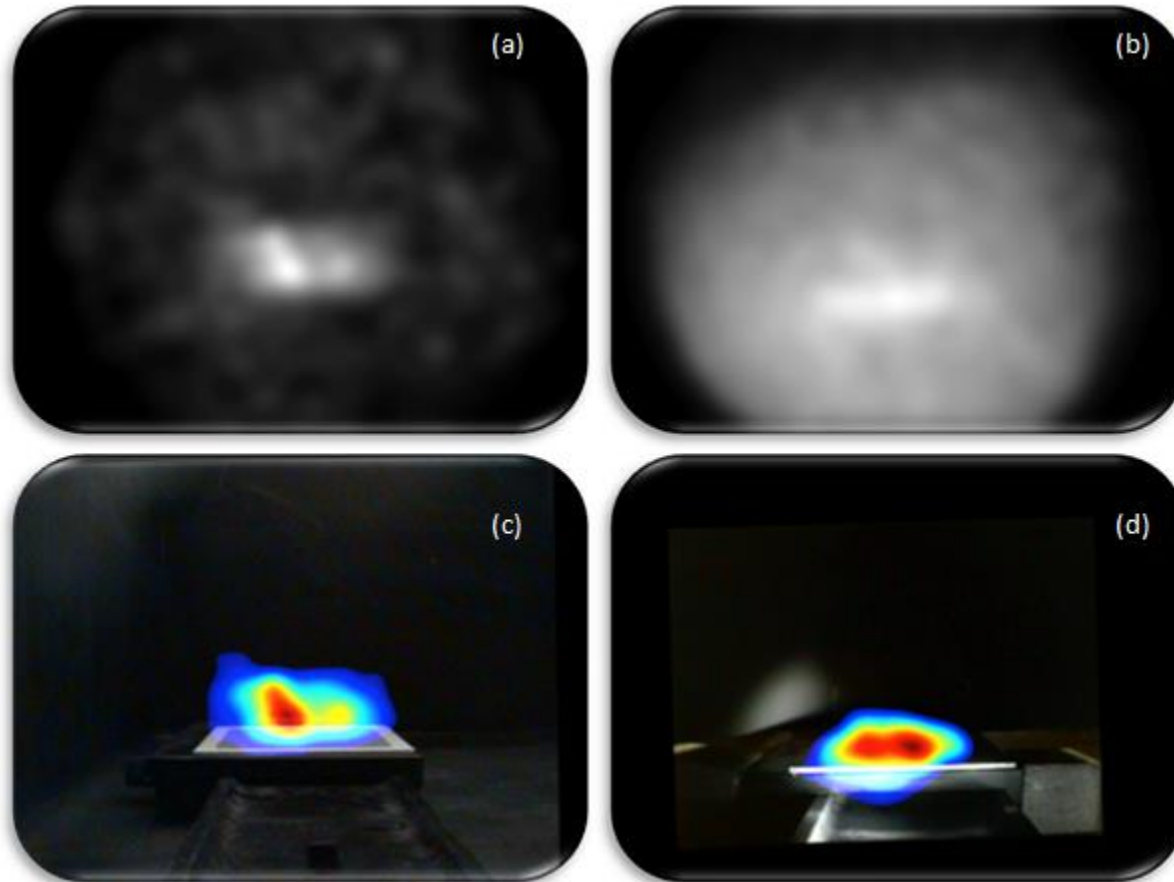

(a, b) Raw Alpha/UV Images with FFT filtering (a : Solar Blind, b : Low-Noise S20)
(c, d) Final superimposition on visible image (c : Solar Blind, d : Low-Noise S20)

Alpha / UV Mode with 550 nm LED-Light Pollution

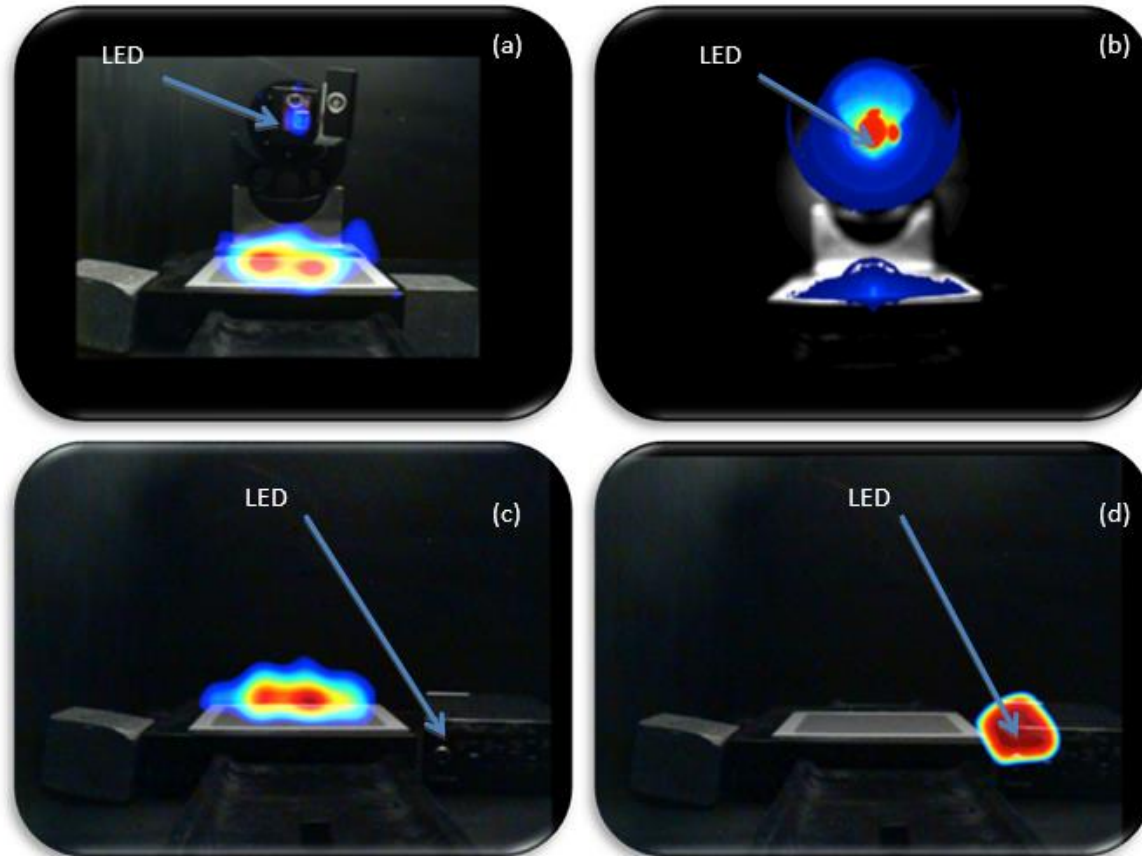

(a, b) Raw Alpha/UV Images with FFT filtering (a : Solar Blind, b : Low-Noise S20)
(c, d) Final superimposition on visible image (c : Solar Blind, d : Low-Noise S20)

Gamma Mode with ^{137}Cs and ^{60}Co sources

Distance between cameras and gamma sources : 1 meter

Several configurations tested with S20/SB intensifier tubes, scintillators and existing pinholes in DENAL®

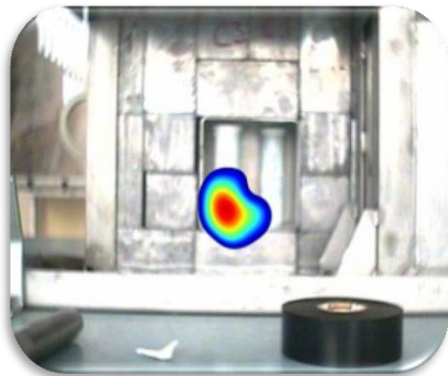
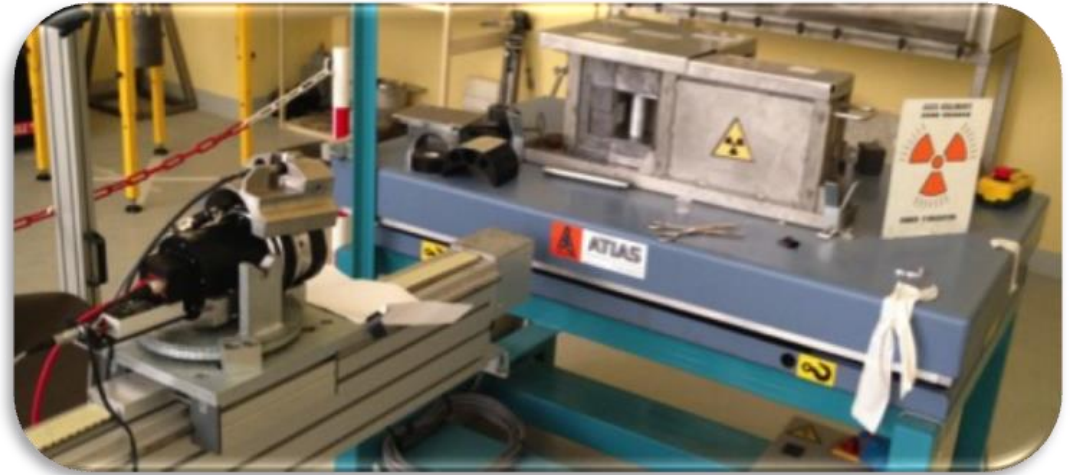

Low-Noise S20 + BGO
1000 frames

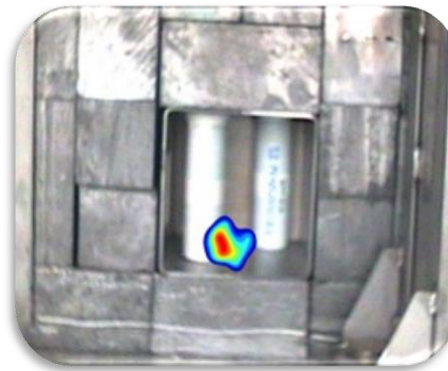

Solar Blind + BaF2 ($\lambda=220$ nm & 310 nm)
1000 frames



View of tubes equipped with ALADIN pinhole and 25 mm diameter scintillator

Scintillators : summary of results

Gamma Detection and localization				
Scintillator	Density (g.cm ⁻³)	Scintillation Wavelength (nm)	LNS20	SB
CdWO ₄	7,9	475	✓	✗
BGO	7,13	480	✓	✗
LYSO	7,1	420	✗	✗
CsI : TI	4,51	550	✓	✗
BaF ₂	4,88	220, 310	✓	✓

Gamma Sensitivity	
Scintillator & tube	Relative Sensitivity (%)
LNS20+CdWO ₄	100
SB+BaF ₂	72
LNS20+BaF ₂	38
BGO+LNS20	32
CsI+LNS20	8,5

- **Alpha Camera** based on a S20 photocathode (25 mm) is under industrialization process
- A new pinhole has been designed to fit with the S20 (25 mm) tube
- Scintillators (d=25 mm, e=4mm) of CdWO_4 , BGO and BaF_2 are considered
- The design of the peripheral shielding is under progress

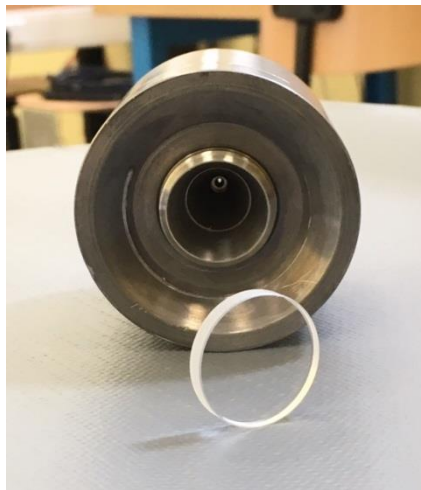
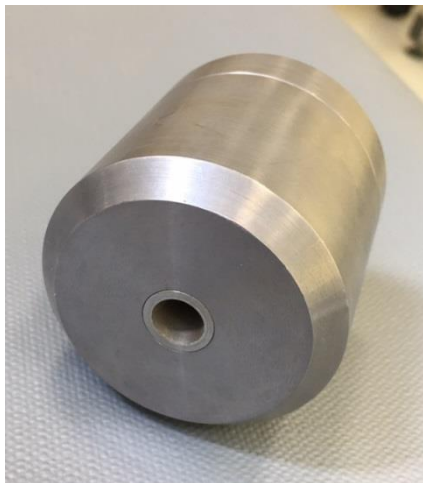

View of the scintillator and the new pinhole design

Thanks for your attention

AirFly / Geant4 References :

1. Bohacova, M. (2011). *Absolute Fluorescence Yield Measurement*. Airfly Collaboration.
2. Fraga, M. (2011). *Temperature Dependence of the UV Fluorescence Yield in Nitrogen and in Dry Air*.
3. GEANT4 Collaboration. (2012). *GEANT4 user's guide for application developpers*.
4. Rodriguez, G. (2008). *Air fluorescence yield dependence on atmospheric parameters*. Airfly Collaboration.
5. Ave, M. (2007). *Spectrally resolved pressure dependence measurements of Air Fluorescence Emission with AIRFLY*. AirFly Collaboration.
6. Ave, M. (2008). *Measurement of the pressure dependence of air fluorescence emission induced by electrons*. Airfly Collaboration.
7. Arqueros, F. (2008). *The yield of air fluorescence induced by electrons*. AirFly Collaboration.

Commissariat à l'énergie atomique et aux énergies alternatives
Centre de Marcoule | DE2D/SEAD/LSTD | Bt 51
BP 17171 | 30207 Bagnols-sur-Cèze cedex
T. +33 (0)4 66 39 79 51 | F. +33 (0)4 66 79 66 25

Etablissement public à caractère industriel et commercial | RCS Paris B 775 685 019

Direction de l'Energie Nucléaire
Département de recherche sur les technologies pour
l'Enrichissement, le Démantèlement et les Déchets
Service d'Etudes des technologies pour
l'Assainissement-Démantèlement et l'étanchéité
Laboratoire de la Simulation et des Techniques de
Démantèlement