



HAL
open science

Overview and current status of the experimental capacity of the LECI hotlab facility

C. Blandin, B. Verhaeghe, A. Lopez, C. Ritter, L. Rancoeur, P. Gavaille, B. Tanguy, J.D. Lulewicz

► To cite this version:

C. Blandin, B. Verhaeghe, A. Lopez, C. Ritter, L. Rancoeur, et al.. Overview and current status of the experimental capacity of the LECI hotlab facility. 54th HOTLAB, Sep 2017, Mito, Japan. cea-02417314

HAL Id: cea-02417314

<https://cea.hal.science/cea-02417314>

Submitted on 18 Dec 2019

HAL is a multi-disciplinary open access archive for the deposit and dissemination of scientific research documents, whether they are published or not. The documents may come from teaching and research institutions in France or abroad, or from public or private research centers.

L'archive ouverte pluridisciplinaire **HAL**, est destinée au dépôt et à la diffusion de documents scientifiques de niveau recherche, publiés ou non, émanant des établissements d'enseignement et de recherche français ou étrangers, des laboratoires publics ou privés.

DE LA RECHERCHE À L'INDUSTRIE

cea

OVERVIEW AND CURRENT STATUS OF THE EXPERIMENTAL CAPACITY OF THE LECI HOTLAB FACILITY

Christophe Blandin, B. Verhaeghe, A. Lopez, C. Ritter,
L. Rancoeur, P. Gavaille, B. Tanguy, JD. Lulewicz

*CEA Saclay, Université Paris-Saclay,
DEN, Service D'Etudes des Matériaux Irradiés,
91191 Gif-Sur-Yvette, France,*

www.cea.fr



1. Context
2. The LECI facility
3. Current experimental capabilities
4. On-going projects
5. Conclusion

Missions of the LECl facility

- To characterize **non-fissile irradiated materials** = Metallurgical, mechanical, physical-chemical characterizations in order :
 - to determine their behavior in normal, accidental or storage conditions
 - to predict their in-service lifetime (+ models)

- Materials from surveillance programs (NPP) or from irradiations in Material Testing Reactors
 - Generation 2&3 reactors:
 - Reactor pressurized vessel (life extension) → embrittlement, mechanical properties
 - Internals (304, 316 steels) → swelling, creep, stress corrosion cracking
 - Zirconium alloys for fuel pin cladding and assembly
 - Generation IV reactors (sodium or gas cooled FBR) :
 - Steels, ODS, ceramics, refractory materials, graphite (fuel pin cladding and assembly)
 - MTR
 - Aluminum alloys (vessel and cladding)

1. CONTEXTE

Operate 45 hotcells



Evacuation of used fuels



Respond to R&D programs

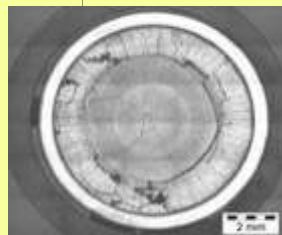

Cell cleanings, Installation of new equipment



1. Context

2. The LECI facility

3. Current experimental capabilities

4. On-going projects

5. Conclusion

2. THE LECI FACILITY



K Line (Active in 1959)

I Line (1970)

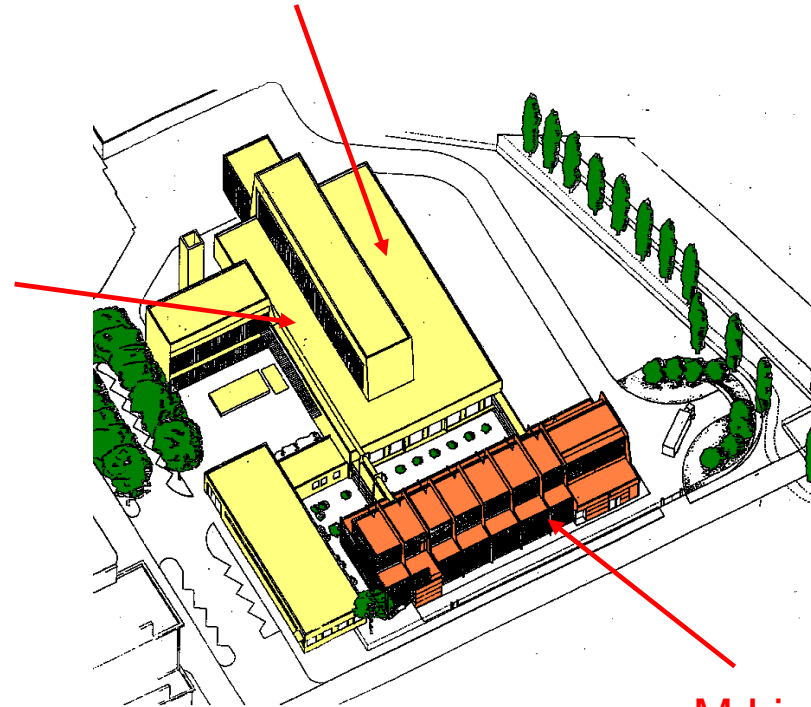

M Line (2005)



2. THE LECI FACILITY

Layout of the I & K Lines

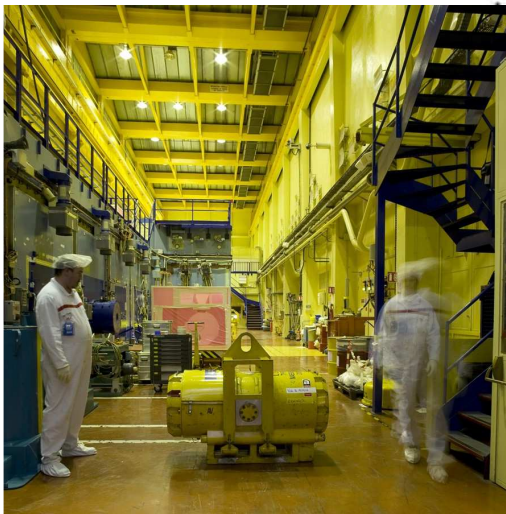
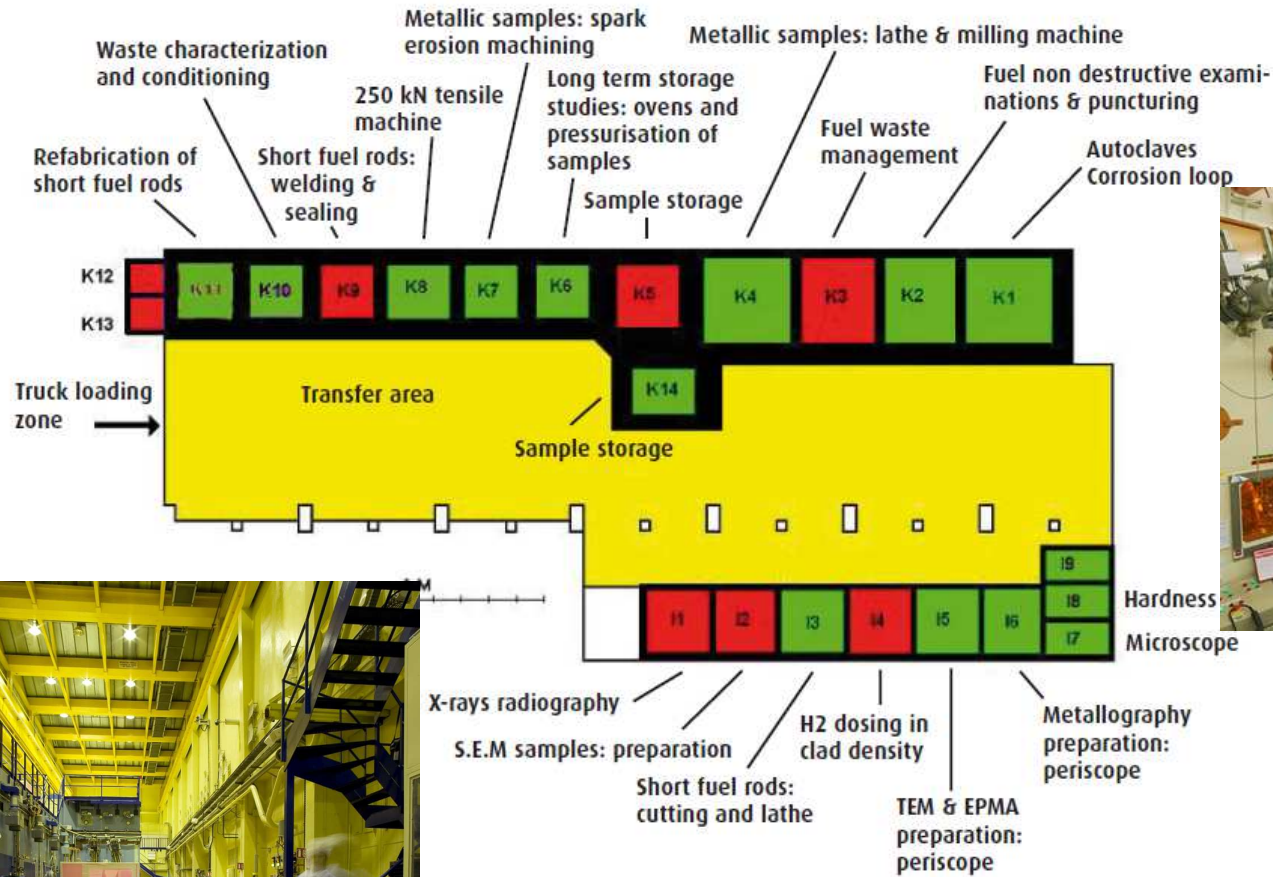

2. THE LECI FACILITY

Layout of the M Line

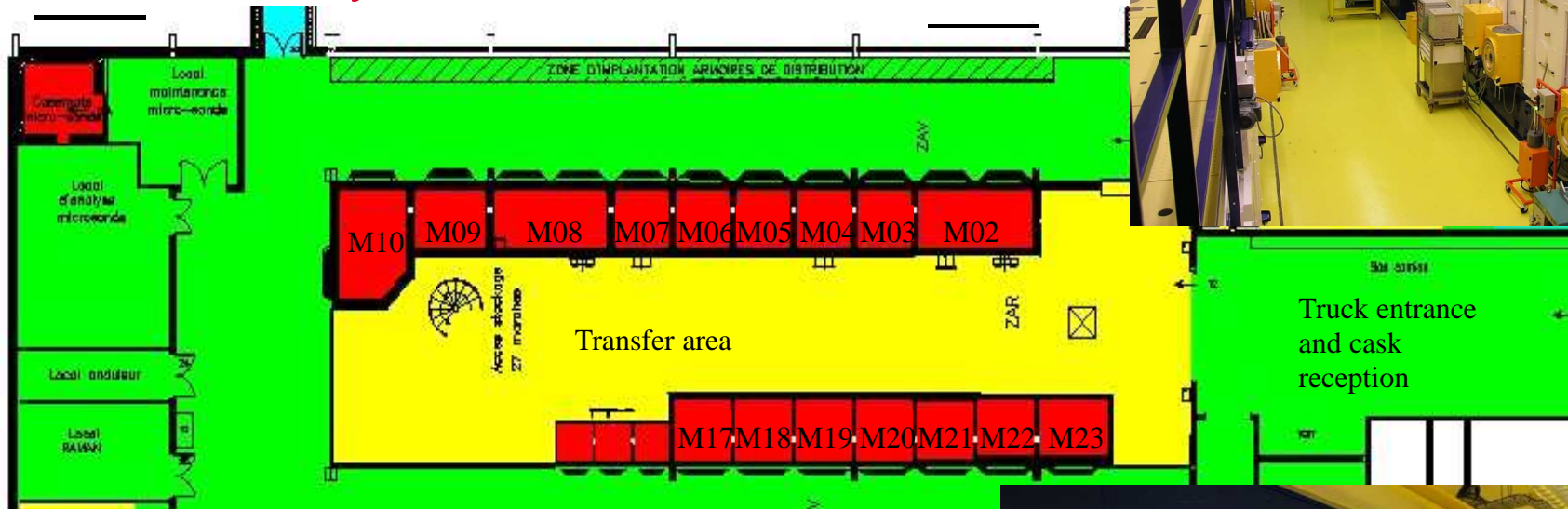

1. Context
2. The LECI facility
- 3. Current experimental capabilities**
4. On-going projects
5. Conclusion

Testing capacity summary

- Metallography and optical microscopy
- SEM, TEM, and EPMA
- Micro-hardness
- Density measurements
- Thermoelectric power
- H₂ measurements
- Eddy currents
- Metrology (non-contact measurements)



- Tensile testing (10, 25 and 100 kN, -170 to 1800°C, dynamic capacities (0.5 m/s), fast heating (induction and Joule effect)
- Fracture toughness (100 and 250 kN, -170 to 1000°C)
- 50 J and 350 J Charpy testing
- Burst machine coupled to tensile testing machine
- Axial creep tests
- Internal pressure creep tests
- Burst and creep under iodine (CSCI)
- 2 Autoclaves (360°C, 220 bar, 1 coupled to slow tensile testing) in hot cell
- Machining (conventional & wire spark erosion machining)
- Welding (TIG and Laser)

CURRENT EXPERIMENTAL CAPABILITIES

Machining of samples

Wire spark erosion machining

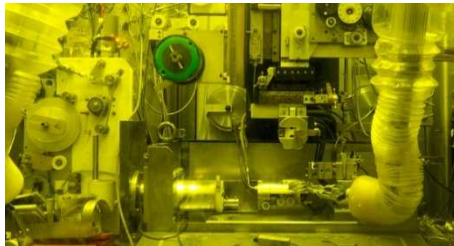

Machined specimen

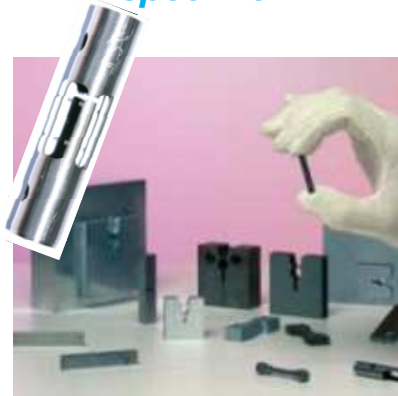

Metallurgical and physico-chemical characterizations

EPMA

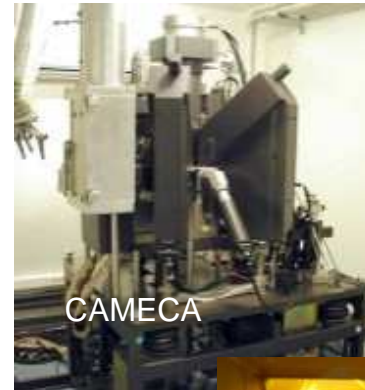

Metallography

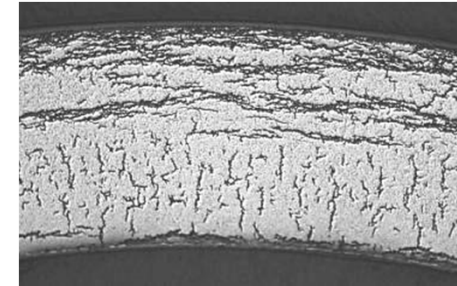

Corrosion (tests & modeling) of irradiated materials

Corrosion loop (2 Autoclaves)

(360°C, 220 bar, 1 coupled to slow tensile testing)



TEM
(FEI 300 kV)

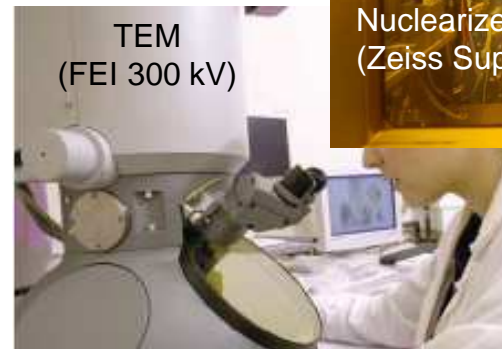

Nuclearized SEM
(Zeiss Supra 55)



CURRENT EXPERIMENTAL CAPABILITIES

Mechanical characterization of irradiated materials (examples)

Toughness Testing Servo-Hydraulic Machine (100 kN)

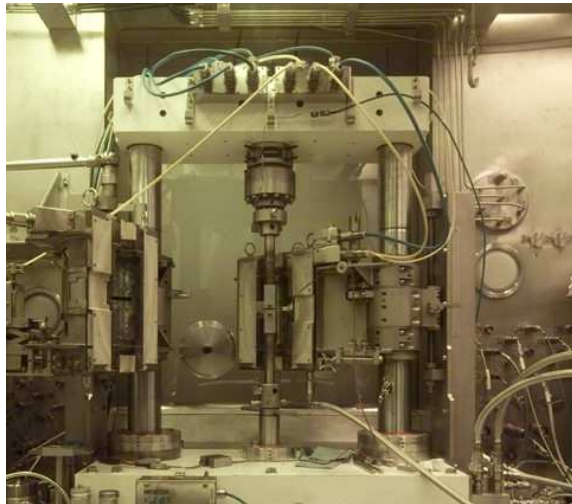

CT 20 specimen after test



350 J Charpy Impact Testing

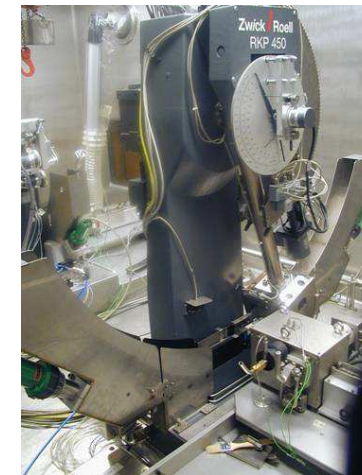

Biaxial Testing of Cladding (Internal Pressure + Axial Load)



biaxial testing / expansion due to compression, inner pressure coupled with axial tensile testing

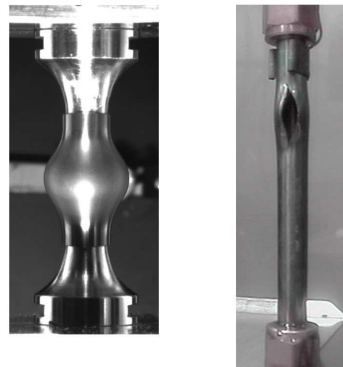

Ductile-Brittle transition (impact tests)

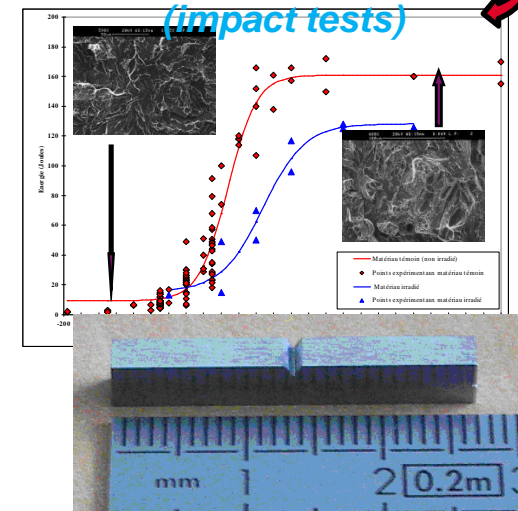

High Temperature (up to 1800°C) Tensile Machine

■ To study the behavior of materials dedicated to the GEN IV reactors (sodium/gas cooled fast reactors), in nominal, incidental and accidental conditions

- stainless steels (ferritic-martensitic ODS steels, austenitic, advanced austenitic)
- other advanced metallic materials
- ceramic composites, such as SiC/SiC

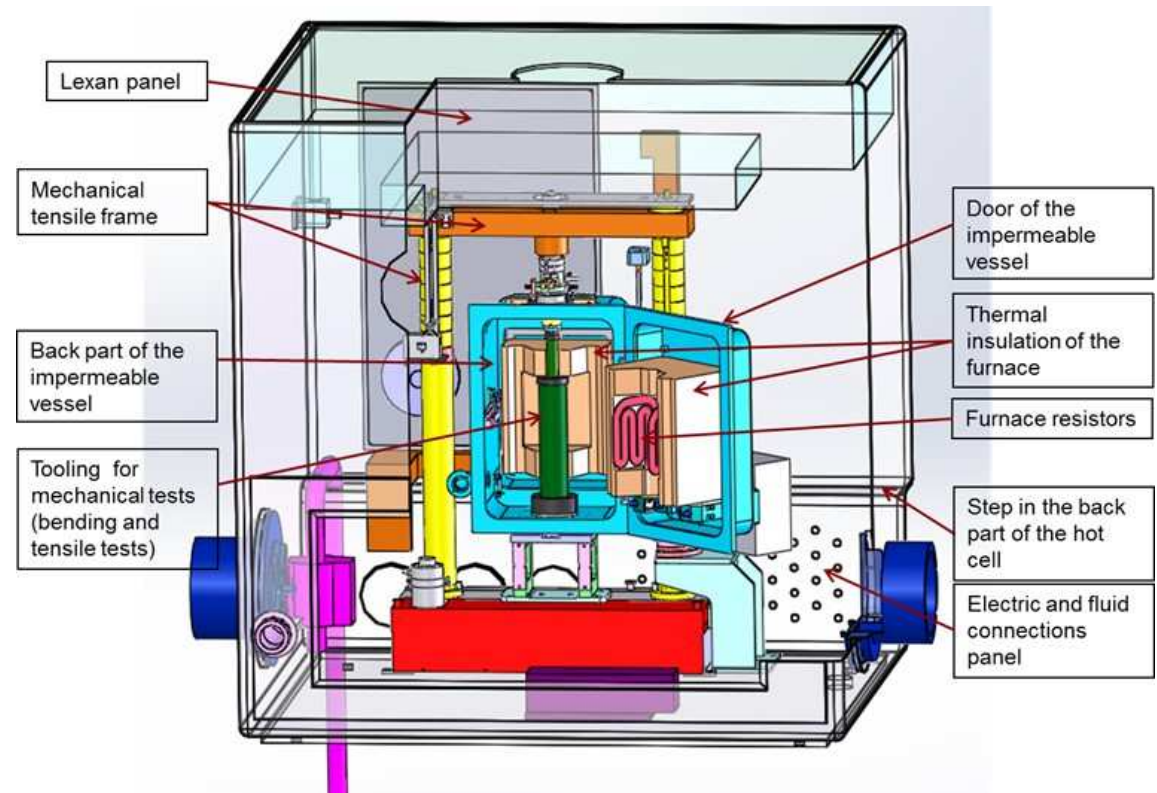

High Temperature (up to 1800°C) Tensile Machine

- Mechanical tensile machine - INSTRON
 - Two alternatively used load cells (10 kN and 1 kN)
 - A 30 kN capacity with a 650 mm wide testing space
 - Maximal travel of the cross rail of about 1135 mm
 - Adjustable speed of the cross rail from 0.001 to 500 mm/min
 - Retraction speed of the cross rail: 600mm/min with controlled deceleration for precise positioning

- Furnace with controlled atmosphere – AET
 - Metallic furnace (molybdenum) : T<1200°C (metallic materials), heating rate : 5°C/min
 - Graphite furnace: T<1800°C (ceramics, graphite), heating rate : 30°C/min
 - Controlled atmosphere (Helium, Argon, vacuum) → to avoid oxidation at the very high testing temperatures



CURRENT EXPERIMENTAL CAPABILITIES

High Temperature (up to 1800°C) Tensile Machine

- Recently installed in hot cell (M line – Cell M18)
- Commissioning tests in progress

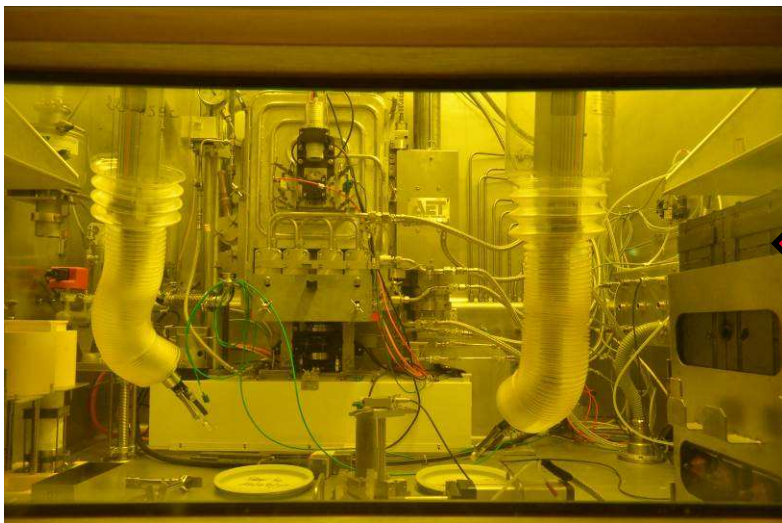

1. Context
2. The LECI facility
3. Current experimental capabilities
- 4. On-going projects**
5. Conclusion

5. ON-GOING PROJECTS

An experimental Platform for the Analysis of Irradiated Material at the Nano-metric Scale

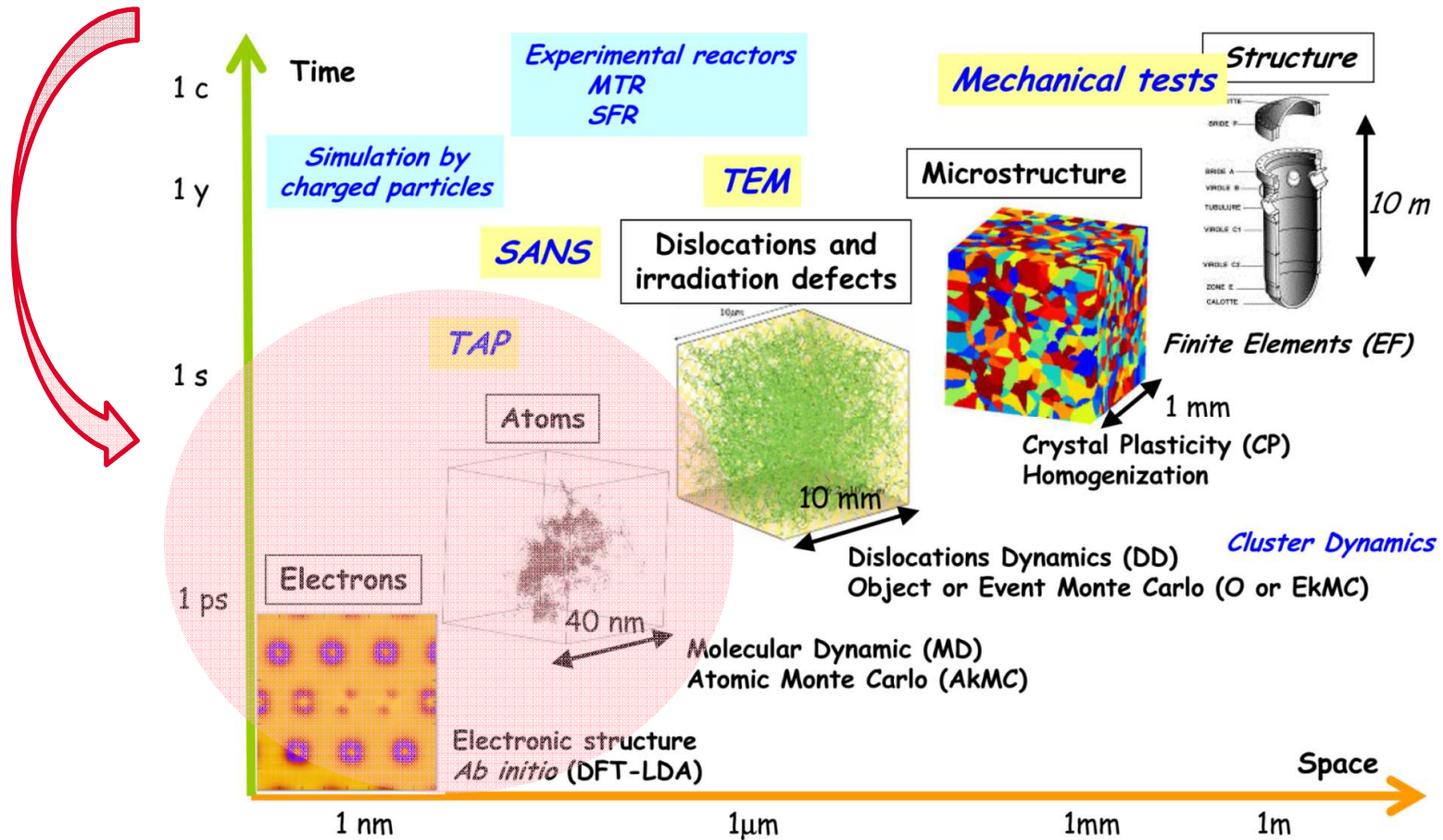

An experimental Platform for the Analysis of Irradiated Material at the Nano-metric Scale

- A SEM with Focused Ion Beam used to :
 - Locate precisely TEM and TAP samples (grain boundaries, end of a crack tip, interface,...)
 - Prepare lower activity TEM and TAP samples (and reduce hazardous liquid wastes)

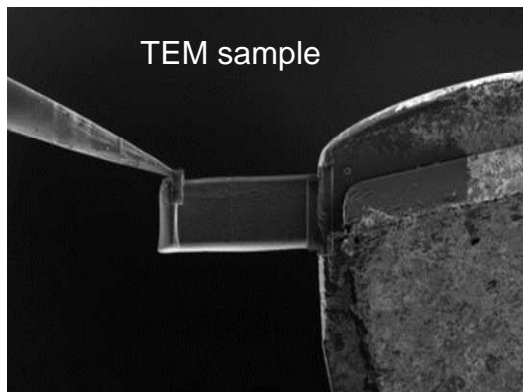

Non nuclearized FIB-SEM
(Zeiss Auriga 40)



An experimental Platform for the Analysis of Irradiated Material at the Nano-metric Scale

- The nuclearized FIB-SEM is in service outside hot cell
- The installation in hot conditions is foreseen mid 2018 (construction of the dedicated shielding in progress ~100 t)

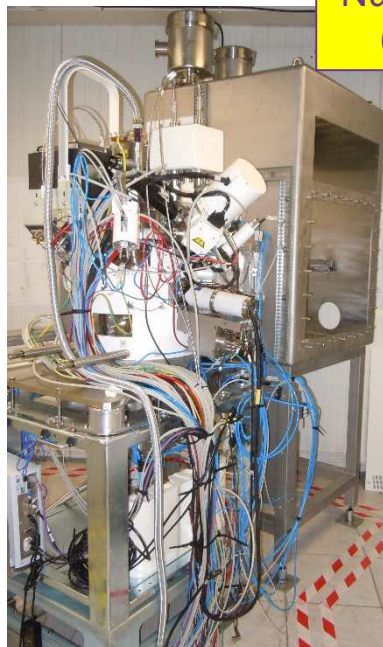

Nuclearized FIB-SEM
(Zeiss Auriga 40)



Défi-Systèmes
ZEISS

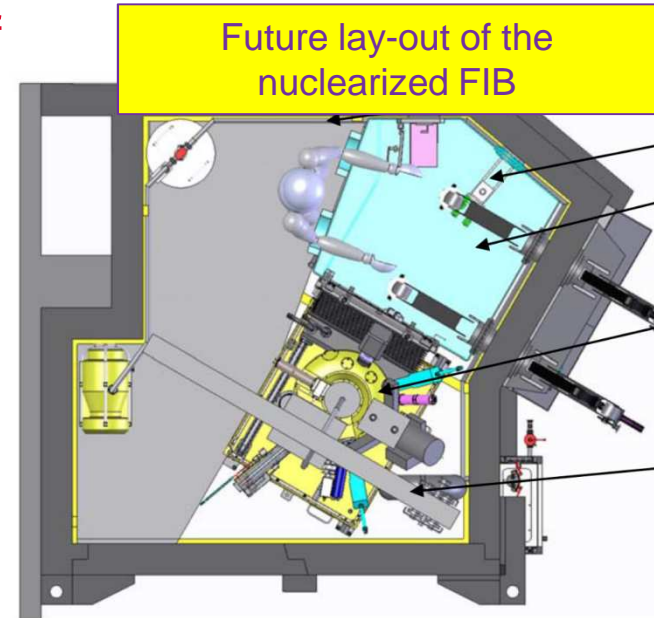

Future lay-out of the nuclearized FIB

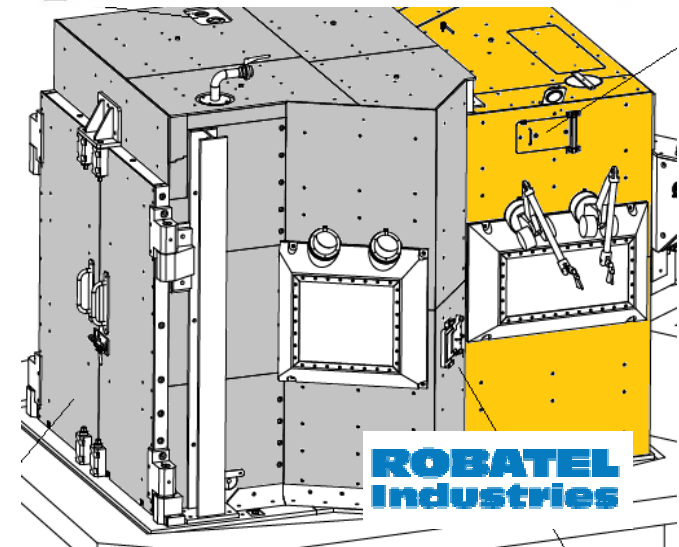

ROBATEL
Industries

An experimental Platform for the Analysis of Irradiated Material at the Nano-metric Scale

- Installation of a TAP achieved in 2013
 - Operating on **ion irradiated material**
 - Used on Al alloys, ODS steels, Fe-Cr model alloys, Zr alloys and Zr oxides
- Installation of a glovebox achieved early 2017
- Operation on neutron irradiated materials is due mid 2018

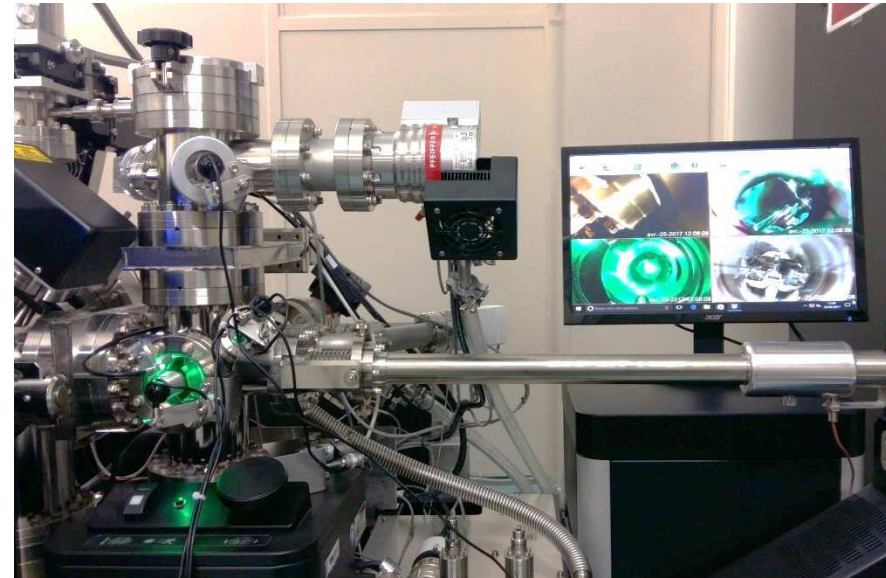
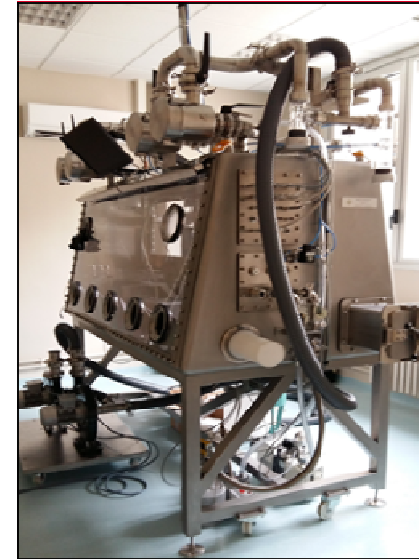

An experimental Platform for the Analysis of Irradiated Material at the Nano-metric Scale

Some examples of research on the TAP and Hot SEM-FIB

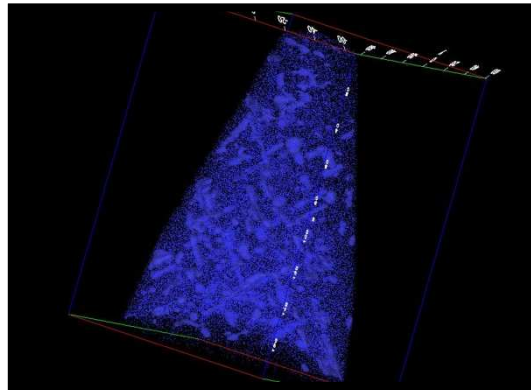

Ion-irradiated Fe-10Cr alloys : Cr segregation on dislocation loops

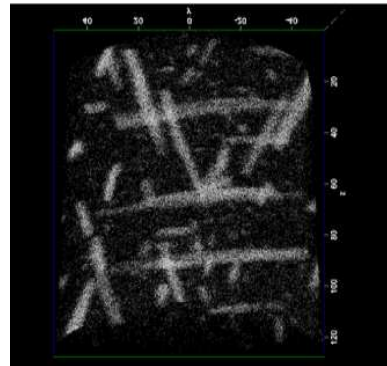

β'' precipitates on 6061-T6 aluminum

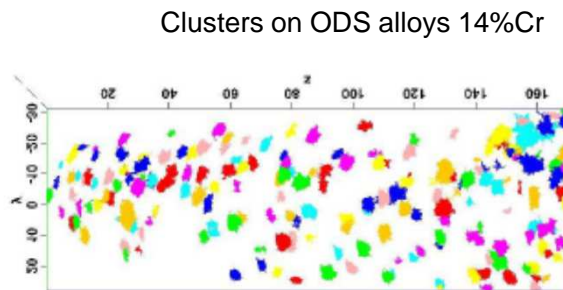

Clusters on ODS alloys 14%Cr

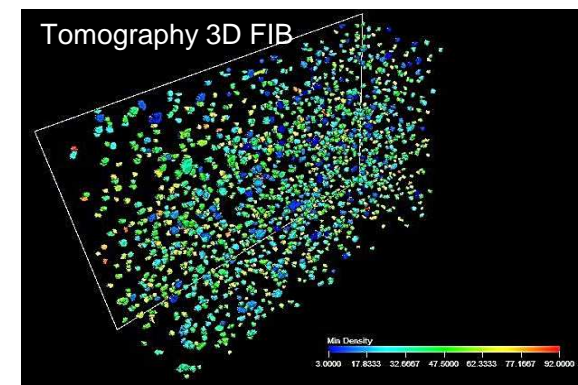
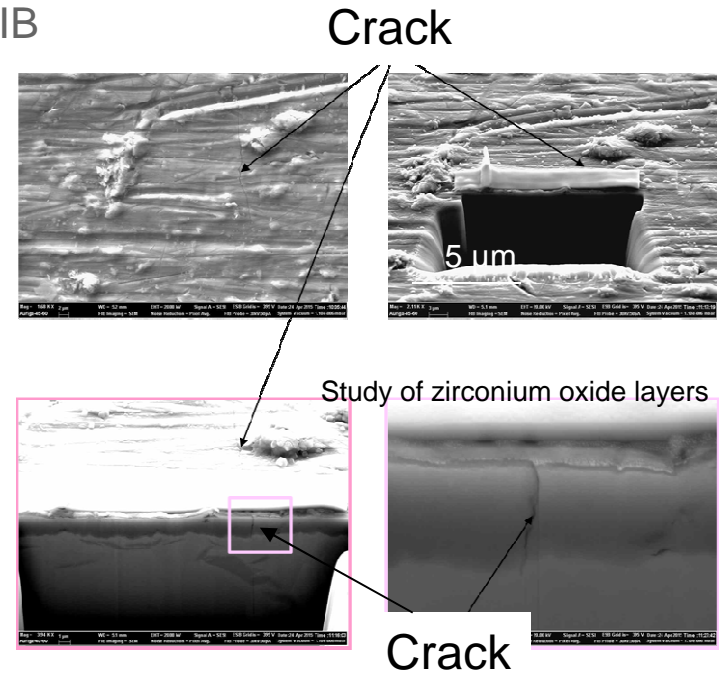
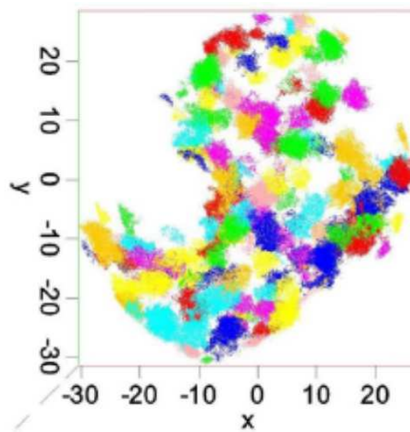

Nota : This work profited from a French government grant managed by the National Agency of Research under the program "Investments for the future" (ref. ANR-11-EQPX-0020)

1. Context
2. The LECI facility
3. Current experimental capabilities
4. On-going projects
- 5. Conclusion**

- LECI → A world-class, comprehensive and modern hot laboratory devoted to the characterization of irradiated non-fissile materials
- The last safety review in 2015 stated the operability of the LECI for the next ten years
- LECI keeps on upgrading its experimental capacities, such as
 - the implementation of a high Temperature Tensile Machine in hot cell
 - the commissioning of a TAP & a SEM-FIB in hot conditions
- LECI is open to national and international clients through direct contracts or international scientific collaboration.

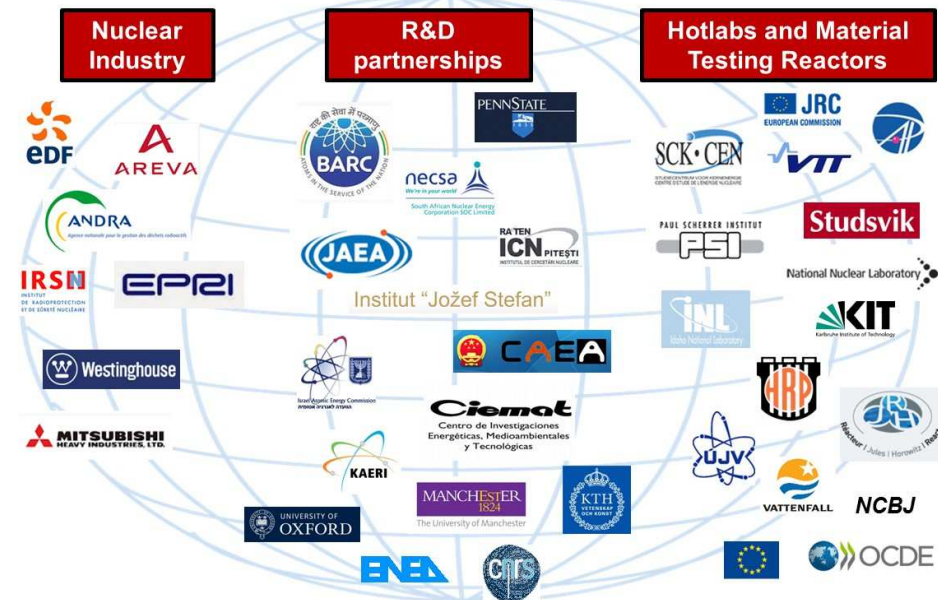



Thank you
for your attention !

christophe.blandin@cea.fr

leci@cea.fr

Commissariat à l'énergie atomique et aux énergies alternatives
Centre de Saclay | 91191 Gif-sur-Yvette Cedex
T. +33 (0)1 69 08 57 89 | F. +33 (0)1 69 08 93 24

Etablissement public à caractère industriel et commercial | R.C.S Paris B 775 685 019

Direction de l'Energie Nucléaire
Direction des activités nucléaires de Saclay
Département des Matériaux pour le Nucléaire
Service d'Etudes des Matériaux Irradiés